



Kanlux

Katalog
Catalogue
20**24**

**more than
light.**

więcej niż
more than **światło.**
light.

Kanlux





14
33

OPRAWY Z FABRYKI KANLUX
KANLUX FACTORY FIXTURES

34
101

ŹRÓDŁA ŚWIATŁA
LIGHT SOURCES

102
205

OPRAWY DOMOWE I DEKORACYJNE
DOMESTIC AND DECORATIVE FIXTURES

206
313

OPRAWY TECHNICZNE I ARCHITEKTONICZNE
TECHNICAL AND ARCHITECTURAL FIXTURES

314
351

OSPRZĘT ELEKTROINSTALACYJNY
ELECTRICAL INSTALLATION EQUIPMENT

**OPRAWY
Z FABRYKI
KANLUX
KANLUX
FACTORY
FIXTURES**

Kanlux
F△CTORY



Kanlux ALIN LED
◀ 16 - 17 ▶

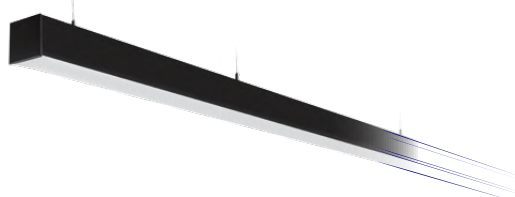

Kanlux ALIN LED LINE
◀ 18 - 19 ▶



Kanlux ALIN 4LED
◀ 20 - 21 ▶

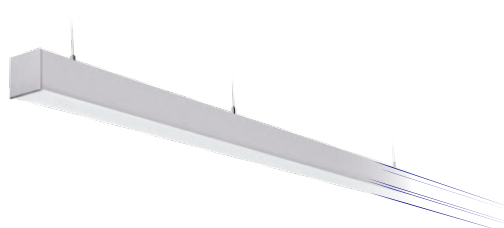

Kanlux ALIN 4LED LINE
◀ 22 - 23 ▶



Kanlux OFIS S LED
◀ 24 - 25 ▶

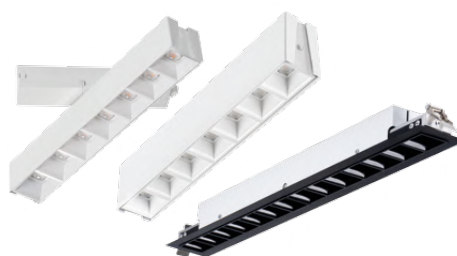

Kanlux HIERRO LED
◀ 26 - 27 ▶



Kanlux FUTURIO LED
◀ 28 - 29 ▶



Kanlux ADTR
◀ 30 - 31 ▶

ŹRÓDŁA ŚWIATŁA
LIGHT SOURCES



Kanlux Kanlux SMART
◀ 36 ▶



Kanlux Kanlux SMART
◀ 37 ▶



Kanlux IQ-LED LIFE
◀ 38 ▶



Kanlux IQ-LED LIFE
◀ 39 ▶



Kanlux IQ-LED A60
◀ 40 ▶



Kanlux IQ-LED A67
◀ 41 ▶



Kanlux IQ-LEDDIM A60
◀ 42 ▶



Kanlux XLED EX A60
◀ 43 ▶



Kanlux XLED A60
◀ 44 ▶



Kanlux XLED A70
◀ 45 ▶



Kanlux XLED A60M
◀ 46 ▶



Kanlux XLED STEPDIM
◀ 47 ▶



Kanlux XLEDIM A60
◀ 47 ▶



Kanlux XLED A60 B22 M
◀ 48 ▶



Kanlux XLEDIM A60 B22
◀ 48 ▶



Kanlux RAPIDv2 LED
◀ 49 ▶



Kanlux ST45 LED
◀ 50 ▶



Kanlux ST64 A
◀ 51 ▶



Kanlux XLED ST64
◀ 51 ▶



Kanlux XLED A60 MIRROR
◀ 52 ▶



Kanlux XLED G95
◀ 52 ▶



Kanlux XLED G125
◀ 53 ▶



Kanlux XLED G125
◀ 53 ▶



XLED SW
◀ 54 ▶



XLED W
◀ 55 ▶



Kanlux IQ-LED C35
◀ 56 ▶



Kanlux XLEDEX C35
◀ 57 ▶



Kanlux XLEDDIM C35
◀ 57 ▶



Kanlux XLED C35
◀ 58 ▶



Kanlux XLED C35M
◀ 58 ▶



Kanlux DUN LED
◀ 59 ▶



Kanlux IDO LED 6,5W
◀ 59 ▶



Kanlux IQ-LED G45
◀ 60 ▶



Kanlux XLEDEX G45
◀ 61 ▶



Kanlux XLED G45
◀ 62 ▶



Kanlux XLED G45M
◀ 63 ▶



Kanlux BILO LED
◀ 64 ▶



Kanlux IQ-LEDEX GU10
◀ 65 ▶



Kanlux IQ-LED GU10 4,9W
◀ 65 ▶



Kanlux IQ-LED GU10
◀ 66 ▶



Kanlux IQ-LEDDIM GU10
◀ 67 ▶



Kanlux K LED GU10 6W
◀ 67 ▶

ŹRÓDŁA ŚWIATŁA
LIGHT SOURCES



Kanlux TOMIV2 LED
◀ 68 ▶



Kanlux REMI LED
◀ 69 ▶



Kanlux TEDI MAXX LED
◀ 69 ▶



Kanlux ZUBI LED
◀ 70 ▶



Kanlux TANO G4
◀ 71 ▶



Kanlux LEDI2 G4
◀ 71 ▶



Kanlux IQ-LED AR-111
◀ 72 ▶



Kanlux IQ-LED ES-111
◀ 72 ▶



Kanlux IQ-LED EX T8
◀ 73 ▶



Kanlux T8 LED GLASSV3
◀ 74 ▶



Kanlux T8 LED GLASSV3T
◀ 74 ▶



Kanlux T8 LED GLASSV4
◀ 75 ▶



Kanlux T8 LED GLASSV5
◀ 75 ▶



Kanlux TOMI LED
◀ 76 ▶



Kanlux SIGO LED
◀ 76 ▶



Kanlux ESG LED
◀ 77 ▶



Kanlux RANGO LED
◀ 77 ▶



Kanlux MODV2 LED
◀ 78 ▶



Kanlux LEDS-B
◀ 79 ▶



Kanlux LED STRIP L60
◀ 80 ▶



Kanlux LED STRIP L120
◀ 81 ▶



Kanlux LED STRIP L120 CCT
◀ 82 ▶



Kanlux LED STRIP LCOB 12V
◀ 83 ▶



Kanlux LED STRIP LCOB 24V
◀ 84 ▶



Kanlux LEDS-B RGB
◀ 85 ▶



Kanlux LED STRIP L48 RGBW
◀ 86 ▶



Kanlux COB SET
◀ 86 ▶



Kanlux CONTROLLER
MONO/CCT
◀ 87 ▶



Kanlux CONTROLLER
RGBW CCT
◀ 87 ▶



Kanlux PROFILO B
◀ 88 ▶

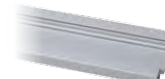

Kanlux PROFILO C
◀ 89 ▶



Kanlux PROFILO D
◀ 90 ▶



Kanlux PROFILO F
◀ 91 ▶



Kanlux PROFILO G
◀ 92 ▶



Kanlux PROFILO H
◀ 93 ▶



Kanlux PROFILO J
◀ 94 ▶



Kanlux PROFILO K
◀ 95 ▶



Kanlux NEON LEDI2W/M
◀ 96 ▶



Kanlux XLED HP D9
◀ 98 ▶



Kanlux XLED HP D46
◀ 98 ▶



Kanlux G9 STAR
◀ 99 ▶



Kanlux J
◀ 99 ▶



Kanlux J STAR
◀ 100 ▶



Kanlux T5
◀ 100 ▶



Kanlux T8
◀ 101 ▶



Kanlux MHE
◀ 101 ▶

**OPRAWY
DOMOWE
I DEKORACYJNE**
DOMESTIC
AND DECORATIVE
FIXTURES



Kanlux AGZAR C
◀ 104 ▶



Kanlux GALOBA C
◀ 104 ▶



Kanlux JASMIN C
◀ 105 ▶



Kanlux ETISSA
◀ 106 ▶



Kanlux OGIVA
◀ 106 ▶



Kanlux SANI IP44
◀ 107 ▶



Kanlux SONOR GU10
◀ 107 ▶



Kanlux AQILO IP65
◀ 108-109 ▶

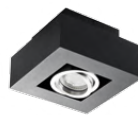

Kanlux STOBI
◀ 110 ▶



Kanlux RITI
◀ 111 ▶



Kanlux BORD
◀ 111 ▶



Kanlux BORD XS
◀ 112 ▶



Kanlux GORD XS
◀ 112 ▶



Kanlux BLURRO
◀ 113 ▶



Kanlux CARVO LED
◀ 114 ▶



Kanlux LUMKO LED
◀ 114 ▶



Kanlux BONSA LED
◀ 115 ▶



Kanlux EXATE LED
◀ 115 ▶



Kanlux SOLN LED
◀ 116 ▶



Kanlux AMAZI LED
◀ 116 ▶



Kanlux VAND LED
◀ 117 ▶



Kanlux RIFA LED
◀ 118-119 ▶



Kanlux ARVOS LED
◀ 120 ▶



Kanlux JASMIN W
◀ 121 ▶



Kanlux JASMIN
◀ 122-123 ▶



Kanlux DERATO
◀ 124-125 ▶



Kanlux EVALO
◀ 126-127 ▶



Kanlux SONDA II
◀ 128-129 ▶



Kanlux GALOBA
◀ 130-131 ▶



Kanlux LAURIN
◀ 132-133 ▶



Kanlux SEMPRA
◀ 134-135 ▶



Kanlux ENALI
◀ 136-137 ▶



Kanlux MILENO
◀ 138-139 ▶



Kanlux BOLA LED
◀ 140 ▶



Kanlux ULUV LED
◀ 140 ▶



Kanlux ORISA LED
◀ 141 ▶



Kanlux HOFI LED
◀ 141 ▶



Kanlux CALIZA LED
◀ 142 ▶



Kanlux GALOBA W
◀ 143 ▶

**OPRAWY DOMOWE
I DEKORACYJNE**
DOMESTIC
AND DECORATIVE
FIXTURES



Kanlux TONIL II LED ◀ 143 ▶	Kanlux AGZAR EL ◀ 144 ▶	Kanlux AGZAR E14 ◀ 144 ▶	Kanlux LARATA EL ◀ 145 ▶	Kanlux LARATA E27 ◀ 145 ▶	Kanlux FLUXY LED IP44 ◀ 146 ▶	Kanlux INITA LED IP54 ◀ 147 ▶
Kanlux EVALO TL ◀ 148 ▶	Kanlux EVALO FL ◀ 149 ▶	Kanlux RAIBO E27 ◀ 150 ▶	Kanlux JUJI E27 ◀ 151 ▶	Kanlux NEDIA E14 ◀ 151 ▶	Kanlux PIXA ◀ 152 ▶	Kanlux HERON II LED ◀ 152 ▶
Kanlux ZARA ◀ 153 ▶	Kanlux SUZI ◀ 153 ▶	Kanlux PRED A LED ◀ 154 ▶	Kanlux REXAR LED ◀ 155 ▶	Kanlux FRANCO II LED ◀ 155 ▶	Kanlux GLOZO DSO ◀ 156 ▶	Kanlux GLOZO DSL ◀ 157 ▶
Kanlux FELINE DSO ◀ 158 ▶	Kanlux FELINE DSL ◀ 159 ▶	Kanlux GOVIK ◀ 160-161 ▶	Kanlux CHIRO GU10 ◀ 162 ▶	Kanlux SPAG ◀ 162 ▶	Kanlux MINI RITI ◀ 163 ▶	Kanlux MINI GORD ◀ 163 ▶
Kanlux MINI BORD ◀ 164 ▶	Kanlux TINY BORD ◀ 164 ▶	Kanlux IMINES ◀ 165 ▶	Kanlux AGEO ◀ 165 ▶	Kanlux APRILA ◀ 165 ▶	Kanlux SEIDY ◀ 166-167 ▶	Kanlux SIMEN DSO ◀ 168 ▶
Kanlux SIMEN DSL ◀ 168 ▶	Kanlux ALOR ◀ 169 ▶	Kanlux ELNIS S ◀ 170 ▶	Kanlux ELNIS L ◀ 170 ▶	Kanlux SOREN ◀ 171 ▶	Kanlux DALLA ◀ 171 ▶	Kanlux ELICEO ◀ 172 ▶

OPRAWY DOMOWE I DEKORACYJNE

DOMESTIC AND DECORATIVE FIXTURES



Kanlux MORTA
◀ 173 ▶



Kanlux MORTA DT
◀ 173 ▶



Kanlux MORTA OCT
◀ 174 ▶



Kanlux MORTA B
◀ 174 ▶



Kanlux IVRI
◀ 175 ▶



Kanlux ARET
◀ 175 ▶



Kanlux ALREN R
◀ 176 ▶



Kanlux ALREN
◀ 176 ▶



Kanlux COLIE
◀ 177 ▶



Kanlux NESTA
◀ 177 ▶



Kanlux EVIT
◀ 178 ▶



Kanlux GWEN
◀ 178 ▶



Kanlux LUTO
◀ 179 ▶



Kanlux NAVI
◀ 179 ▶



Kanlux VIDI
◀ 180 ▶



Kanlux RADAN
◀ 181 ▶



Kanlux TESON
◀ 181 ▶



Kanlux HORN
◀ 181 ▶



Kanlux ARGUS II
◀ 182-183 ▶



Kanlux TRIBIS II
◀ 184-185 ▶



Kanlux DROXY IP65
◀ 186 ▶

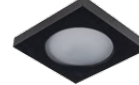

Kanlux FLINI IP44
◀ 186 ▶



Kanlux QULES
◀ 187 ▶



Kanlux MARIN
◀ 187 ▶



Kanlux OVO
◀ 188 ▶



Kanlux IMBER LED
◀ 188 ▶



Kanlux ASTIM LED IP44
◀ 189 ▶



Kanlux ROLSO
◀ 189 ▶



Kanlux ASTEN LED IP44
◀ 190-191 ▶



Kanlux AKVO IP44 S
◀ 192 ▶



Kanlux AKVO IP44
◀ 193 ▶



Kanlux ERINUS LED
◀ 194-195 ▶



Kanlux APUS LED
◀ 196 ▶



Kanlux TERRA LED
◀ 197 ▶



Kanlux SABIK LED
◀ 198 ▶



Kanlux SOLA LED
◀ 199 ▶



Kanlux IRS 3XAAA
◀ 200 ▶



Kanlux MEFIS LED
◀ 200 ▶



Kanlux ZEPO
◀ 202 ▶



Kanlux MERA LED
◀ 203 ▶



Kanlux HAXA LED
◀ 204 ▶



Kanlux LINUS LED
◀ 204 ▶



Kanlux GAVI CT
◀ 205 ▶



Kanlux GAVI LED
◀ 205 ▶



**OPRAWY
TECHNICZNE
I ARCHITEKTONICZNE**
TECHNICAL
AND ARCHITECTURAL
FIXTURES

Kanlux BLINGO LED ◀ 208-209 ▶	Kanlux BLINGO CV ◀ 210-211 ▶	BRAVO LED ◀ 212-213 ▶	Kanlux AVAR LED ◀ 214 ▶	Kanlux REGIS ◀ 216 ▶	Kanlux REGIS 4LED ◀ 217 ▶	Kanlux NOTUS ◀ 218 ▶
Kanlux NOTUS 4LED ◀ 219 ▶	Kanlux TP STRONG ◀ 220 ▶	Kanlux TP SLIM LED ◀ 221 ▶	Kanlux TP SLIM TW LED ◀ 221 ▶	Kanlux MAH LED HI ◀ 222 ▶	Kanlux MAH LED N ◀ 223 ▶	Kanlux MAH PLUS 4LED ◀ 224 ▶
Kanlux MAH PLUS ◀ 225 ▶	Kanlux MEBA LED IP54 ◀ 226 ▶	Kanlux MEBA 4LED IP54 ◀ 226 ▶	Kanlux MEBA LED ◀ 227 ▶	Kanlux MEBA 4LED ◀ 227 ▶	Kanlux ALDO 4LED ◀ 228-229 ▶	Kanlux IPER LED ◀ 230-231 ▶
Kanlux BENO LED ◀ 232-233 ▶	Kanlux VARSO LED ◀ 234-235 ▶	Kanlux STIVI LED ◀ 236 ▶	Kanlux ORTE LED ◀ 237 ▶	Kanlux DABA PRO ◀ 238 ▶	Kanlux DABA N LED SMD ◀ 238 ▶	Kanlux TYBIA LED ◀ 239 ▶
Kanlux JURBA DL ◀ 240 ▶	Kanlux PIRES DL ◀ 241 ▶	Kanlux FOGLEK LED ◀ 242 ▶	Kanlux FOGLEK DL ◀ 242 ▶	Kanlux SANSO LED ◀ 243 ▶	Kanlux MARC DL ◀ 243 ▶	Kanlux ERTON ◀ 244 ▶
Kanlux PLAFMIN ◀ 244 ▶	Kanlux HERMI ◀ 245 ▶	Kanlux MILO ◀ 245 ▶	Kanlux INES ◀ 246 ▶	Kanlux SANGA DL ◀ 246 ▶	Kanlux TUNA ◀ 247 ▶	Kanlux TURK ◀ 247 ▶



**OPRAWY
TECHNICZNE
I ARCHYTEKTONICZNE**
TECHNICAL
AND ARCHITECTURAL
FIXTURES



Kanlux HIMA LED
◀ 248-249 ▶



Kanlux TIBERI PRO
◀ 250 ▶



Kanlux TIBERI PRO NT
◀ 251 ▶



Kanlux AREL LED
◀ 252 ▶



Kanlux MATEO ES
◀ 253 ▶



Kanlux IVIAN LED
◀ 253 ▶



Kanlux TAVO LED
◀ 254-255 ▶



Kanlux ROUNDA V2LED
◀ 256-257 ▶



Kanlux KATRO V2LED
◀ 258 ▶



Kanlux CARSA V2LED
◀ 260 ▶



Kanlux KANTI V2LED
◀ 261 ▶



Kanlux FL AGOR LED
◀ 262 ▶



Kanlux FL AGOR HI
◀ 263 ▶



Kanlux IQ-LED FL
◀ 264 ▶



Kanlux ANTEM LED
◀ 266 ▶



Kanlux STATO LED
◀ 267 ▶



Kanlux FL SONE SLR
◀ 268 ▶



Kanlux FL SOLNAR SLR
◀ 269 ▶



Kanlux STRETON LED
◀ 270 ▶



Kanlux HB PRO LED HI
◀ 272 ▶



Kanlux REKA LED
◀ 274 ▶



Kanlux BISO LED
◀ 275 ▶



Kanlux GARTO LED
◀ 275 ▶



Kanlux ZEWE EL
◀ 276 ▶



Kanlux BART EL
◀ 277 ▶



Kanlux LART EL
◀ 277 ▶



Kanlux DULI LED
◀ 278 ▶



Kanlux GLASI LED
◀ 279 ▶



Kanlux TAXI SMD
◀ 279 ▶



Kanlux TURRO LED
◀ 280 ▶



Kanlux GORDO N
◀ 281 ▶



Kanlux ROGER DL
◀ 281 ▶



Kanlux BERG AD
◀ 282 ▶



Kanlux BERG DL
◀ 282 ▶



Kanlux XARD DL
◀ 283 ▶



Kanlux MORO N
◀ 283 ▶



Kanlux ABETE LED
◀ 285 ▶



Kanlux PEVO
◀ 286 ▶



Kanlux LAVEN
◀ 287 ▶



Kanlux PRESO
◀ 288 ▶



Kanlux SELTO
◀ 289 ▶



Kanlux LIEGO
◀ 290 ▶

OPRAWY TECHNICZNE I ARCHITEKTONICZNE TECHNICAL AND ARCHITECTURAL FIXTURES



Kanlux VIMO
◀ 291 ▶



Kanlux GORI
◀ 292 ▶



Kanlux VADRA
◀ 293 ▶



Kanlux INVO OP
◀ 294 ▶



Kanlux INVO TR
◀ 295 ▶



Kanlux STONO N
◀ 296 - 296 ▶



Kanlux USTI SP
◀ 298 ▶



Kanlux VORA
◀ 299 ▶



Kanlux GRIBLO 7 GR
◀ 300 ▶



Kanlux AKVEN LED
◀ 300 ▶



Kanlux GRL
◀ 301 ▶



Kanlux DASTO
◀ 302 ▶



Kanlux NASTO
◀ 302 ▶



Kanlux ACORD ATLI
◀ 304-305 ▶



Kanlux ACORD AT2 GU10
◀ 306 ▶



Kanlux ACORD AT3 GU10
◀ 306 ▶



Kanlux ACORD AT4 GU10
◀ 307 ▶



Kanlux ACORD AT5 GU10
◀ 307 ▶



Kanlux BTL LED
◀ 308 ▶



Kanlux BTLW LED
◀ 309 ▶



Kanlux TEAR N
◀ 310 ▶

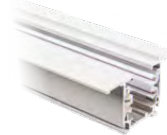

Kanlux TEAR N RC
◀ 311 ▶



Kanlux TEAR N PADAPTOR
◀ 313 ▶

OSPRZĘT SMART SMART EQUIPMENT



Kanlux SMART
◀ 316 ▶



Kanlux SMART
◀ 316 ▶



Kanlux SMART
◀ 317 ▶



Kanlux SMART
◀ 318 ▶



Kanlux SMART
◀ 319 ▶



Kanlux SMART
◀ 319 ▶



Kanlux SMART
◀ 319 ▶

OSPRZĘT ELEKTROINSTALACYJNY ELECTRICAL INSTALLATION EQUIPMENT



Kanlux SQMOTION
◀ 322 ▶



Kanlux ALER-N
◀ 322 ▶



Kanlux ZONA MINI
◀ 323 ▶



Kanlux ZONA MINI WT
◀ 323 ▶



Kanlux SENTO-O
◀ 324 ▶



Kanlux SENSQUARE
◀ 324 ▶



Kanlux MERGE-WT
◀ 325 ▶



Kanlux SLICK JQ
◀ 325 ▶



Kanlux ALER JQ
◀ 326 ▶



Kanlux ALER MINI
◀ 326 ▶



Kanlux ZONA JQ-37
◀ 327 ▶

OSPRZĘT ELEKTROINSTALACYJNY ELECTRICAL INSTALLATION EQUIPMENT



Kanlux ZONA
◀ 327 ▶



Kanlux MERGE JQ
◀ 328 ▶



Kanlux MARID JQ
◀ 328 ▶



Kanlux ROLF JQ
◀ 329 ▶



Kanlux ROLF JQ
◀ 329 ▶



Kanlux ROLF JQ
◀ 330 ▶



Kanlux MERGE JQ
◀ 330 ▶



Kanlux MERGE
◀ 331 ▶



Kanlux MERGE
◀ 331 ▶



Kanlux SENTO
◀ 332 ▶



Kanlux SENZO
◀ 332 ▶



Kanlux AZ-10A
◀ 333 ▶



Kanlux CYBER
◀ 334 ▶



Kanlux STER TS-MF
◀ 334 ▶



Kanlux ADI
◀ 335 ▶



Kanlux POWELED
◀ 335 ▶



Kanlux CIRCO
◀ 336 ▶



Kanlux DRIVE LED
◀ 336 ▶



Kanlux SET
◀ 336 ▶



Kanlux WIR ZL
◀ 337 ▶



Kanlux TWISTER
◀ 337 ▶



Kanlux CYKLON
◀ 338 ▶



Kanlux GRIP
◀ 339 ▶



Kanlux STAN GP
◀ 339 ▶



Kanlux PIN W/US
◀ 339 ▶



Kanlux ZARK
◀ 340 ▶



Kanlux APO
◀ 340 ▶



Kanlux BR-GZ10
◀ 340 ▶



Kanlux HLDR-E14
◀ 341 ▶



Kanlux HLDR-E14
◀ 341 ▶



Kanlux HLDR-E27
◀ 341 ▶



Kanlux HLDR-E27
◀ 342 ▶



Kanlux HLDR-E27
◀ 342 ▶



Kanlux HLDR-G9
◀ 342 ▶



Kanlux HLDR-GX5.3
◀ 343 ▶



Kanlux HLDR-GZ10
◀ 343 ▶



Kanlux HLDR-R75
◀ 343 ▶



Kanlux ONTEC S
◀ 344 ▶



Kanlux ONTEC S
◀ 345 ▶



Kanlux ITECH
◀ 346 ▶



Kanlux ONTEC G
◀ 347 ▶



Kanlux ONTEC C
◀ 347 ▶



Kanlux ONTEC R
◀ 348 ▶



Kanlux PICTO G
◀ 349 ▶



Kanlux PICTO S
◀ 350 ▶



Kanlux IT
◀ 351 ▶

Kanlux





Kanlux
FACTORY

OPRAWY Z FABRYKI KANLUX
KANLUX FACTORY FIXTURES

Nasze kompletne rozwiązania możemy dostosować specjalnie do Twoich potrzeb. Dbłość o każdy szczegół i idealne dopasowanie to właśnie produkty z Fabryki Kanlux. Poznaj je już dziś!

Our complete solutions can be adjusted to your needs. Attention to every detail and perfect fit are what characterises Kanlux Factory products. Discover them today!



*dane fotometryczne znajdziesz na:
photometric data you can find on:*

► [kanlux.com](https://www.kanlux.com)

ALIN LED

OPRAWA LINIOWA LED ► LINEAR LIGHTING FIXTURES

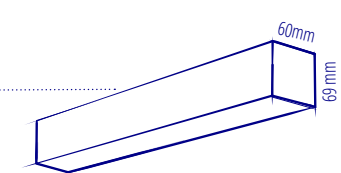
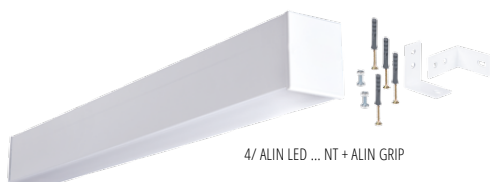
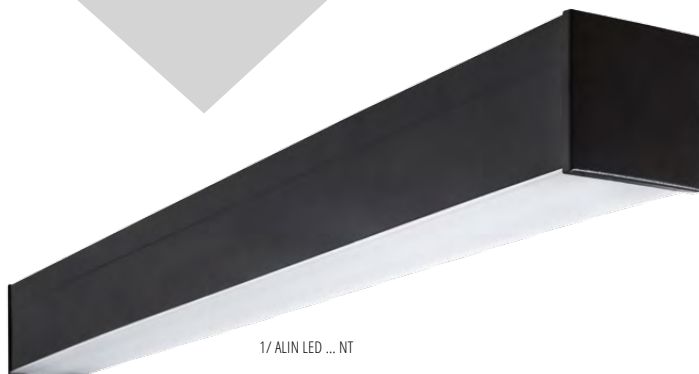

PIĘĆ WERSJI
FIVE VERSIONS

TRZY DŁUGOŚCI:
THREE LENGTHS:
580MM
1140MM
1700MM

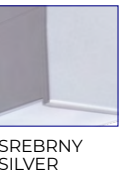
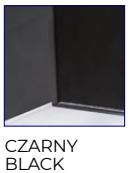
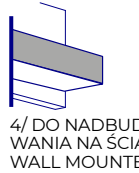
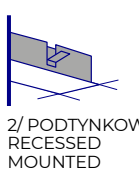

Kanlux FACTORY



Kanlux ALIN LED to oprawy, które powstały z myślą o oświetleniu idealnym. Stworzyli je projektanci Kanlux, którzy połączyli innowację z ponad 30-letnim doświadczeniem. Markowe komponenty i perfekcyjne wykonanie zapewniają estetykę i trwałość działania opraw Kanlux ALIN przez długie lata. Szeroka oferta modeli daje możliwość indywidualnego dopasowania oprawy do potrzeb każdej inwestycji.

5 lat Gwarancji na warunkach oświadczenia gwarancyjnego, dostępnego na stronie internetowej: www.kanlux.com

The Kanlux ALIN LED is a product which was created with a view to a perfect fixture. It was created by the Kanlux designers, who combined innovation with 30 years of experience. Their branded components and perfect workmanship ensure the aesthetics and durability of operation for many years. The wide range of models affords the possibility to adjust the fixture to the needs of each investment.

5 years Warranty under the terms of the warranty statement, available on our website: www.kanlux.com

CONFIGURATOR



Wyprodukujemy dla Ciebie oprawę idealną. Stwórz ją z pomocą naszego konfiguratora.

We will produce a perfect luminaire for you. Create it with our configurator.



DWIE BARWY ŚWIATŁA I OPCJA WYKONANIA Z TUNABLE WHITE
TWO COLOR TEMPERATURES AND OPTION WITH TUNABLE WHITE



CO NAS WYRÓŻNIA?

TRZY KOLORY
OBUDOWY
THREE
HOUSING
COLORS

LEGENDA ► KEY

AL	KANLUX ALIN LED
ALD	KANLUX ALIN LED DALI
ALC	CASAMBI READY
S	580mm
M	1140mm
L	1700mm
S	super niska moc / super low power
L	niska moc / low power
M	średnia moc / medium power
H	duża moc / high power
WW	3000K Ra ≥ 80
NW	4000K Ra ≥ 80
TW	tunable white
MAT	klosz matowy / matt lampshade
MPR	klosz mikropryzmatyczny / microprismatic lampshade
W	kolor obudowy: biały / housing colour: white
B	kolor obudowy: czarny / housing colour: black
S	kolor obudowy: srebrny / housing colour: silver
NT	wersja natynkowa / surface-mounted
PT	wersja podtynkowa / recessed mounted
ALIN +ALIN CORD +ROPE	wersja wisząca / suspended mounted
ALIN +ALIN NT GRIP	wersja do nadbudowania na ścianie / wall mounted
RM	montowane do szynoprzewodu / rail mounted
SE	wersja z czujnikiem ruchu / motion sensor
AS	asymetryczny układ optyczny / asymmetric optic system



WSZYSTKIE KODY OPRAW Z FABRYKI KANLUX ZNAJDZIESZ W KATALOGU FABRYKA KANLUX / ALL THE CODES OF KANLUX FACTORY FIXTURES YOU CAN FIND IN THE KANLUX FACTORY CATALOGUE



		MAT		MPR	
		WW (830)	NW (840)	WW (830)	NW (840)
SL	10W	1150lm	1300lm	1050lm	1200lm
SH	19W	2250lm	2550lm	2050lm	2350lm
MS	18W	2150lm	2400lm	2050lm	2250lm
ML	25W	2980lm	3250lm	2750lm	3000lm
MM	29W	3450lm	3900lm	3170lm	3600lm
MH	40W	4500lm	5050lm	4150lm	4650lm
LL	33W	4100lm	4550lm	3750lm	4150lm
LH	52W	5600lm	6300lm	5150lm	5800lm

WHAT MAKES US DIFFERENT?

DOWOLNA PERSONALIZACJA KOLORU OBUDOWY CUSTOMIZATION OF THE HOUSING COLOR



DWA RODZAJE DYFUZORA TWO TYPES OF DIFFUSER



MATOWY MATT



MIKROPRYZMATYCZNY MICROPRISMATIC

WYSOKIEJ JAKOŚCI MODUŁ LED HIGH QUALITY LED MODULE



MARKOWE DIODY I ZASILACZE OSRAM/TRIDONIC OSRAM/TRIDONIC BRANDED LEDS AND OSRAM/TRIDONIC DRIVERS



OPCJONALNIE STEROWANIE DALI DALI LED DRIVER AVAILABLE AS AN OPTION



ALIN LED LINE

OPRAWA LINIOWA LED ► LINEAR LIGHTING FIXTURES

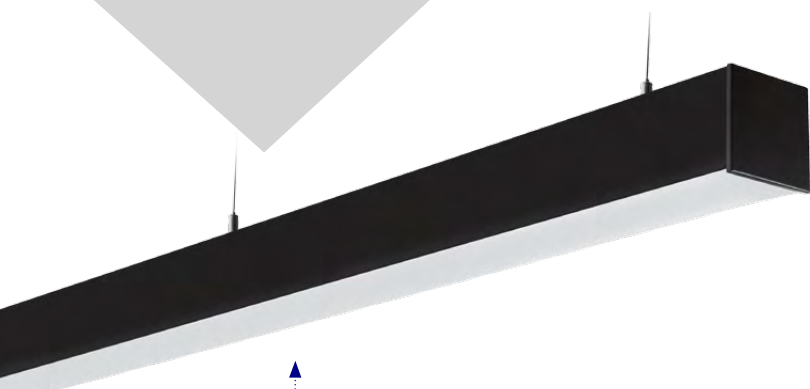

Kanlux ALIN LED LINE to innowacyjny system oświetleniowy stworzony w oparciu o idealnie dopracowane oprawy Kanlux ALIN LED. Rozwiązanie to pozwala na stworzenie długich linii świetlnych o prostych lub niestandardowych kształtach. Pełne dopasowanie do konkretnej inwestycji daje możliwości osiągnięcia niepowtarzalnego efektu przy każdej realizacji z użyciem Kanlux ALIN LED LINE.



5 lat Gwarancji na warunkach oświadczenia gwarancyjnego, dostępnego na stronie internetowej: www.kanlux.com



Kanlux ALIN LED LINE is an innovative lighting system created based on perfectly prepared Kanlux ALIN LED luminaires. This solution allows for creating long light lines with straight or custom shapes. Full adaptation to the specific investment enables creation of a unique effect in each project using Kanlux ALIN LED LINE.



5 years Warranty under the terms of the warranty statement, available on our website: www.kanlux.com



NIEOGRANICZONA DŁUGOŚĆ LINII ŚWIETLNEJ O ZŁOŻONYCH STRUKTURACH I KształTACH
UNLIMITED LENGTH OF LIGHTING LINE WITH COMPLEX STRUCTURES AND SHAPES



ALIN LED LINE TO NIESZABLONOWE PROJEKTY NA BAZIE ELEMENTÓW: LF / LM / LL
KształTOWNIKÓW: X / T / L
ŁĄCZNIKÓW: LTX1 / LTX1C / LTX2C / LTX1E
ALIN LED LINE IS UNCONVENTIONAL PROJECTS BASED ON ELEMENTS: LF / LM / LL
PASSIVE PROFILE CONNECTORS: X / T / L
ACTIVE CONNECTORS: LTX1 / LTX1C / LTX2C / LTX1E

CONFIGURATOR



Wyprodukujemy dla Ciebie oprawę idealną. Stwórz ją z pomocą naszego konfiguratora.

We will produce a perfect luminaire for you. Create it with our configurator.

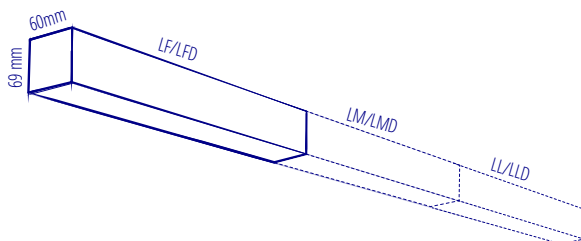
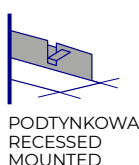

CZTERE ŁĄCZNIKI:
FOUR ACTIVE
CONNECTORS:
LTX1
LTX1C
LTX2C
LTX1E

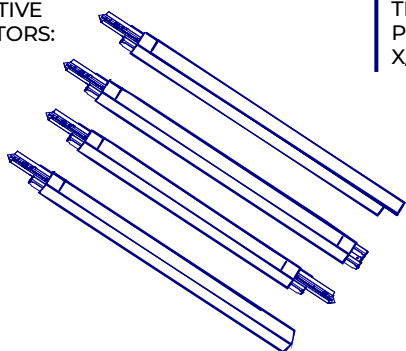

TRZY KształTOWNIKI:
THREE PASSIVE
PROFILE:
X/T/L

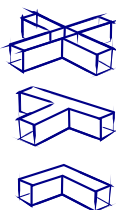

DWIE BARWY ŚWIATŁA I OPCJA
WYKONANIA Z TUNABLE WHITE
TWO COLOR TEMPERATURES
AND OPTION WITH
TUNABLE WHITE



LEGENDA ► KEY

LF	1137mm element początkowy / 1137mm first component
LM	1124mm element środkowy / 1124mm middle component
LL	1137mm element końcowy / 1137mm last component
LFD	1137mm element początkowy DALI / 1137mm first component DALI
LMD	1124mm element środkowy DALI / 1124mm middle component DALI
LLD	1137mm element końcowy DALI / 1137mm last component DALI
L-X, LD-X	kształtka typu X, DALI / X-shaped connector, DALI type X connector
L-L, LD-L	kształtka typu L, DALI / L-shaped connector, DALI L type connector
L-T, LD-T	kształtka typu T, DALI / T-shaped connector, DALI T-connector
LTX1	łącznik LED: linia → kształtka / long straight connector → connector (LTX)
LTX1C	łącznik LED: kształtka → linia / LTX connector → long straight connector
LTX2C	łącznik LED kształtka → kształtka / LTX connector → LTX connector
LTX1E	element LED kończący linię za kształtką / element ending the line behind the LTX connector
S	super niska moc / super low power
L	niska moc / low power
M	średnia moc / medium power
H	duża moc / high power
WW	3000K Ra ≥ 80
NW	4000K Ra ≥ 80
TW	tunable white
MAT	klosz matowy / matt lampshade
MPRM	klosz mikropryzmatyczny / microprismatic lampshade
W	kolor obudowy: biały / housing colour: white
B	kolor obudowy: czarny / housing colour: black
S	kolor obudowy: srebrny / housing colour: silver

NT	wersja natynkowa / surface-mounted
PT	wersja podtynkowa / recessed mounted
ALIN +ALIN NT GRIP	wersja do nadbudowania na ścianie / wall mounted
ALIN +CORD +ROPE	wersja wisząca / suspended mounted

	MAT		MPR	
	WW (830)	NW (840)	WW (830)	NW (840)
MS	18W	2150lm	2400lm	2050lm
ML	25W	2980lm	3250lm	2750lm
MM	29W	3450lm	3900lm	3600lm
MH	40W	4500lm	5050lm	4650lm

(lm)

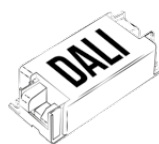

OPCJONALNIE STEROWANIE DALI I CASAMBI READY DALI LED DRIVER AND CASAMBI READY AVAILABLE AS AN OPTION

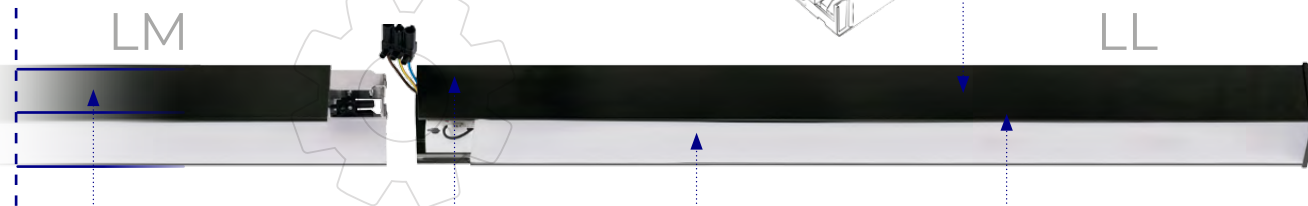

DOWOLNA PERSONALIZACJA KOLORU OBUDOWY
CUSTOMIZATION OF THE HOUSING COLOR

TRZY KOLORY OBUDOWY
THREE HOUSING COLORS

DWA RODZAJE DYFUZORA
TWO TYPES OF DIFFUSER

OPCJA Z WBUDOWANYM, NIEWIDOCZNYM, MIKROFALOWYM CZUJNIKIEM RUCHU
OPTION WITH BUILT-IN, HIDDEN MICROWAVE MOTION SENSOR

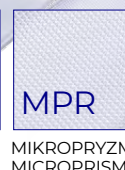
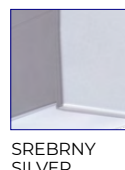
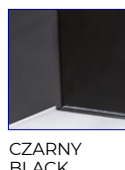
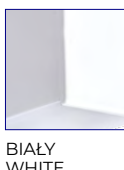

Kanlux

ALIN 4LED

OPRAWA LINIOWA POD TUBY T8 LED ▶ T8 LED TUBE LINEAR FITTINGS



1/ ALIN 4LED



2/ ALIN 4LED ... NT + ALIN GRIP



3/ ALIN 4LED ... NT

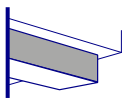

3/ NATYNKOWA
SURFACE
MOUNTED

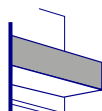

2/ DO NADBUDO-
WANIA NA SCIANIE
WALL MOUNTED

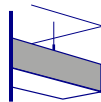

1/ ZWIESZANA
SUSPENDED
MOUNTED

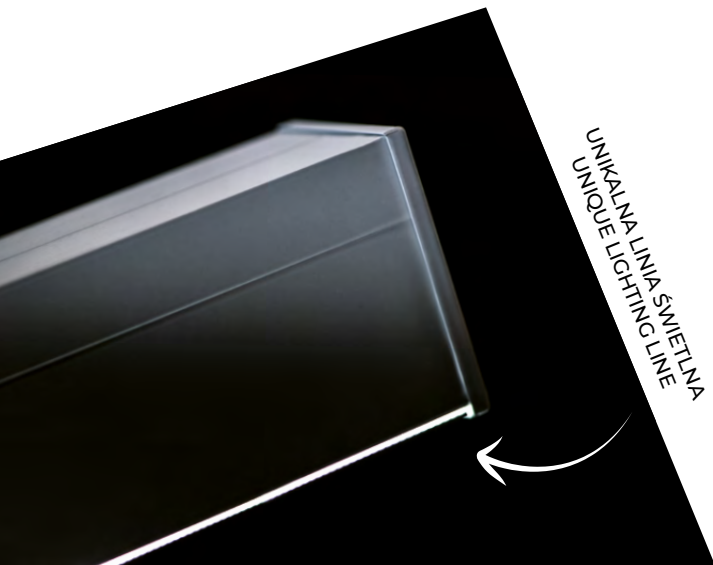

UNIKALNA LINIA ŚWIETLNA
UNIQUE LIGHTING LINE

Kanlux FACTORY



Kanlux ALIN 4LED to oprawa dostosowana do tub T8 LED. To rozwiązanie dla tych, którzy cenią sobie wymienne źródło światła. Markowe komponenty i perfekcyjne wykonanie zapewniają estetykę i trwałość działania przez długie lata. Szeroka oferta modeli daje możliwość dopasowania oprawy do potrzeb każdej inwestycji.



5 lat Gwarancji na warunkach oświadczenia gwarancyjnego, dostępnego na stronie internetowej: www.kanlux.com

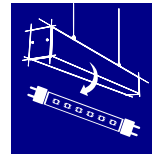

The Kanlux ALIN 4LED is a fixture adapted to T8 LED fluorescent lamps. It is a solution for those who appreciate a replaceable light source. The branded components and perfect workmanship ensure the aesthetics and durability of operation for many years. The wide range of models affords the possibility to adjust the fixture to the needs of each investment.

5 years Warranty under the terms of the warranty statement, available on our website: www.kanlux.com

CONFIGURATOR



Wyprodukujemy dla Ciebie oprawę idealną. Stwórz ją z pomocą naszego konfiguratora.

We will produce a perfect luminaire for you. Create it with our configurator.



DOWOLNA
PERSONALIZACJA
KOLORU OBUDOWY
CUSTOMIZATION
OF THE HOUSING
COLOR



CO NAS WYRÓŻNIA?

TRZY DŁUGOŚCI:
THREE LENGTHS:
633MM
1244MM
1544MM

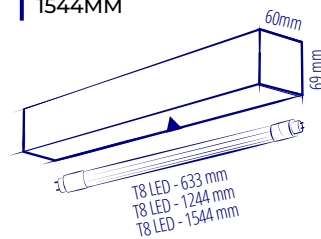

LEGENDA ► KEY

AL 4LED	KANLUX ALIN 4LED
MAT	klosz matowy / matt lampshade
MPR	klosz mikropryzmatyczny / microprismatic lampshade
W	kolor obudowy: biały / housing colour: white
B	kolor obudowy: czarny / housing colour: black
S	kolor obudowy: srebrny / housing colour: silver
NT	wersja natynkowa / surface-mounted
ALIN +ALIN NT GRIP	wersja do nadbudowania na ścianie / wall mounted
ALIN +CORD +ROPE	wersja wisząca / suspended mounted
SE	wersja z czujnikiem ruchu / motion sensor



WSZYSTKIE KODY OPRAW
Z FABRYKI KANLUX ZNAJDZIESZ
W KATALOGU FABRYKA KANLUX
/ ALL THE CODES OF KANLUX
FACTORY FIXTURES YOU CAN
FIND IN THE KANLUX FACTORY
CATALOGUE



BIAŁY
WHITE

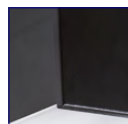

CZARNY
BLACK



SREBRNY
SILVER

TRZY
KOLORY
OBUDOWY
THREE HOUSING
COLORS

WHAT MAKES US DIFFERENT?

WYMIENNE ŹRÓDŁO ŚWIATŁA:
ZALECANE ŚWIETŁÓWKI
IQ LED KANLUX
REPLACEABLE LIGHT
SOURCE: RECOMMENDED
IQ LED KANLUX TUBES



DWA RODZAJE DYFUZORA
TWO TYPES OF DIFFUSER



MATOWY
MATT

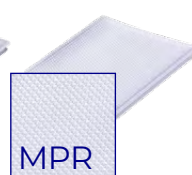

MIKROPRYZMATYCZNY
MICROPRISMATIC

OPCJA Z WBUDOWANYM,
NIEWIDOCZNYM, MIKROFALOWYM
CZUJNIKIEM RUCHU
OPTION WITH BUILT-IN, HIDDEN
MICROWAVE MOTION SENSOR



ALIN 4LED LINE

OPRAWA LINIOWA POD TUBY T8 LED ▶ T8 LED TUBE LINEAR FITTINGS



**NIEOGRANICZONA DŁUGOŚĆ
LINII ŚWIETLNEJ
UNLIMITED LENGTH
OF LIGHT LINE**



**MOŻLIWOŚĆ ŁĄCZENIA
W LINIE OPRAW ALIN 4LED
O DŁUGOŚCI 1230MM
POSSIBLE TO COMBINE IN A LINE
OF ALIN 4LED LUMINAIRES WITH
A LENGTH OF 1230MM**

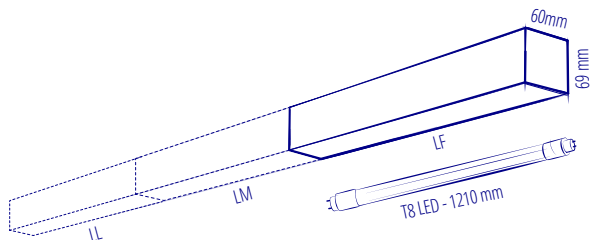

**WYMIENNE ŹRÓDŁO ŚWIATŁA:
ZALECANE ŚWIETŁÓWKI
IQ LED KANLUX
REPLACEABLE LIGHT
SOURCE: RECOMMENDED
IQ LED KANLUX TUBES**

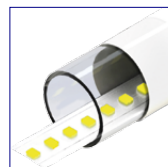

Wyjątkowe rozwiązanie, które wykorzystuje oprawy z wymiennym źródłem światła T8LED do stworzenia modnej i funkcjonalnej linii świetlnej. Nieograniczona długość linii, uniwersalne, dopasowane do Twoich potrzeb wzornictwo oraz swoboda w wyborze i zmianie parametrów źródła światła w każdym momencie eksploatacji daje możliwość stworzenia wyjątkowo dopasowanego systemu oświetleniowego.



5 lat Gwarancji na warunkach oświadczenia gwarancyjnego, dostępnego na stronie internetowej: www.kanlux.com

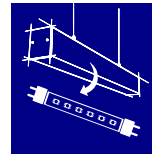

A unique solution that uses luminaires with replaceable light sources T8LED to create a fashionable and functional light line. Unlimited line length, universal design suited to your needs as well as the freedom to choose and change the parameters of the light source at any time enable the creation of an exceptionally tailored lighting system.

5 years Warranty under the terms of the warranty statement, available on our website: www.kanlux.com

CONFIGURATOR



Wyprodukujemy dla Ciebie oprawę idealną. Stwórz ją z pomocą naszego konfiguratora.

We will produce a perfect luminaire for you. Create it with our configurator.

LEGENDA ► KEY

LF	1364mm element początkowy / 1364mm first component
LM	1221mm element środkowy / 1221mm middle component
LL	1097mm element końcowy / 1097mm last component
MAT	klosz matowy / matt lampshade
MPRM	klosz mikropryzmatyczny / microprismatic lampshade
W	kolor obudowy: biały / housing colour: white
B	kolor obudowy: czarny / housing colour: black
S	kolor obudowy: srebrny / housing colour: silver
NT	wersja natynkowa / surface-mounted
ALIN +CORD +ROPE	wersja wisząca / suspended mounted
ALIN +ALIN NT GRIP	wersja do nadbudowania na ścianie / wall mounted

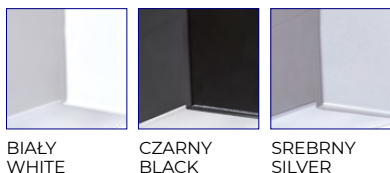

BIAŁY
WHITE

CZARNY
BLACK

SREBRNY
SILVER

TRZY
KOLORY
OBUDOWY
THREE HOUSING
COLORS

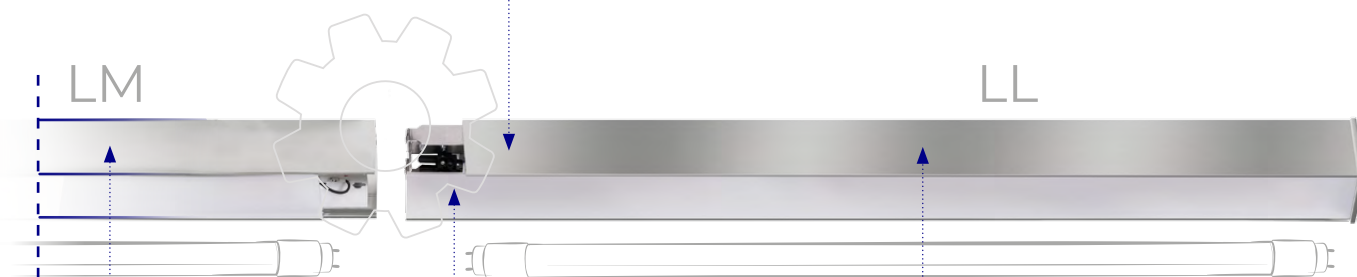

DOWOLNA
PERSONALIZACJA
KOLORU OBUDOWY
CUSTOMIZATION
OF THE HOUSING
COLOR



DWA RODZAJE
DYFUZORA
TWO TYPES OF
DIFFUSER



MATOWY
MATT

MIKROPRYZMATYCZNY
MICROPRISMATIC

OPCJA Z WBUDOWANYM,
NIEWIDOCZNYM, MIKROFALOWYM
CZUJNIKIEM RUCHU
OPTION WITH BUILT-IN, HIDDEN
MICROWAVE MOTION SENSOR



OFIS S LED

OPRAWA BIUROWA LED ► LED OFFICE FIXTURE



1/ OFIS S LED ... NT...N4



2/ OFIS S LED ... PT...P1



1/ OFIS S LED ... NT...N3



2/ OFIS S LED ... PT...P3

DWIE WERSJE
TWO VERSIONS



1/ NATYNKOWA
SURFACE
MOUNTED



2/ PODTYNKOWA
RECESSED
MOUNTED

DWA KOLORY
OBUDOWY
TWO HOUSING
COLORS



BIAŁY
WHITE



CZARNY
BLACK



TRZY BARWY
ŚWIATŁA I OPCJA
WYKONANIA
Z TUNABLE WHITE
THREE COLOR
TEMPERATURES
AND OPTION
WITH TUNABLE
WHITE



Kanlux OFIS S LED to seria nowoczesnych opraw przeznaczonych przede wszystkim do powierzchni biurowych. Prosta, wyjątkowo płaska obudowa czyni oprawę bardzo elegancką dzięki czemu idealnie wpisują się ona w płaszczyznę sufitu. Możliwość wyboru koloru obudowy, dyfuzora oraz temperatury barwowej czyni ją wyjątkowo wszechstronną, a unikatowa konstrukcja maksymalnie przyspiesza montaż. Nowa generacja rastra pozwoliła ograniczyć efekt ośnienia do bardzo niskich poziomów.

5 lat Gwarancji na warunkach oświadczenia gwarancyjnego, dostępnego na stronie internetowej: www.kanlux.com

Kanlux OFIS S LED is a series of modern luminaires intended primarily for office spaces. The simple, extremely flat casing makes the luminaire very elegant so it blends perfectly into the ceiling plane. The possibility of selecting the casing colour, the diffuser and the colour temperature makes it eminently versatile, and the unique design accelerates assembly to the maximum.

5 years Warranty under the terms of the warranty statement, available on our website: www.kanlux.com

CONFIGURATOR



Wyprodukujemy dla Ciebie oprawę idealną. Stwórz ją z pomocą naszego konfiguratora.

We will produce a perfect luminaire for you. Create it with our configurator.

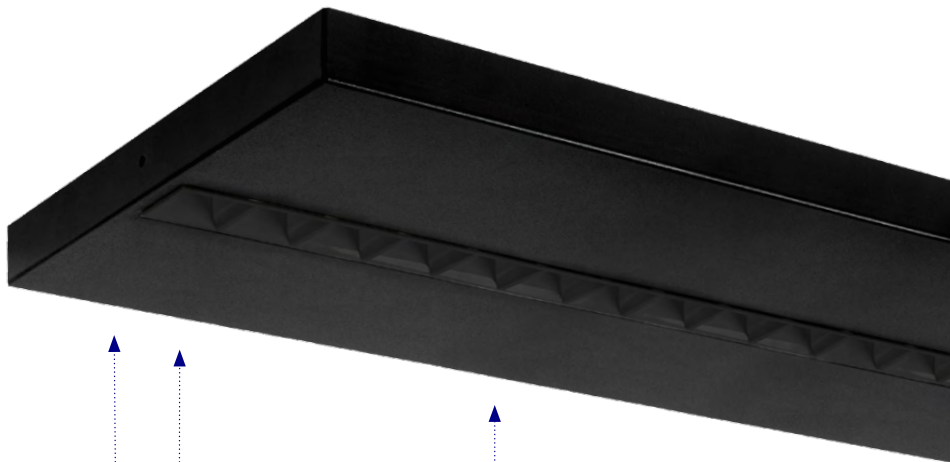

LEGENDA ► KEY

OS	OFIS S LED
OSD	OFIS S LED DALI
OSC	OFIS S LED CASAMBI READY
40W	moc [W] wersja MPR / power [W] MPR version
S	super niska moc 22W / super low power 22W
L	niska moc 31W / low power 31W
M	średnia moc 39W / medium power 39W
H	wysoka moc 49W / high power 49W
5D	układ optyczny z soczewką 50 stopni / optical system with 50 degree lens
8D	układ optyczny z soczewką 80 stopni / optical system with 80 degree lens
WW/830	Ra≥80 3000K
WN/835	Ra≥80 3500K
NW/840	Ra≥80 4000K
TW	wykonanie TUNABLE WHITE / TUNABLE WHITE (CCT)
MPRM	klosz mikropryzmatyczny / microprismatic diffuser
RST	raster / raster
W	kolor obudowy: biały / housing white
B	kolor obudowy: czarny / housing black
N1	wersja natynkowa 600x600mm / surface 600x600mm
N3	wersja natynkowa 1200x300mm / surface 1200x300mm
P1	wersja podtynkowa 595x595mm / recessed 5x9x595mm

P3	wersja podtynkowa 1195x295mm / recessed 1195x295mm
SE	wersja z czujnikiem ruchu / version with the motion sensor
EM	wersja z wbudowaną oprawą awaryjną / version with built-in emergency module



WSZYSTKIE KODY OPRAW Z FABRYKI KANLUX ZNAJDZIESZ W KATALOGU FABRYKA KANLUX / ALL THE CODES OF KANLUX FACTORY FIXTURES YOU CAN FIND IN THE KANLUX FACTORY CATALOGUE

S/W	3200lm	UGR ≤ 14
S/B	2800lm	UGR ≤ 14
L/W	4300lm	UGR ≤ 15
L/B	3800lm	UGR ≤ 15
M/W	5400lm	UGR ≤ 16
M/B	4800lm	UGR ≤ 16
H/W	6300lm	UGR ≤ 16
H/B	5600lm	UGR ≤ 16

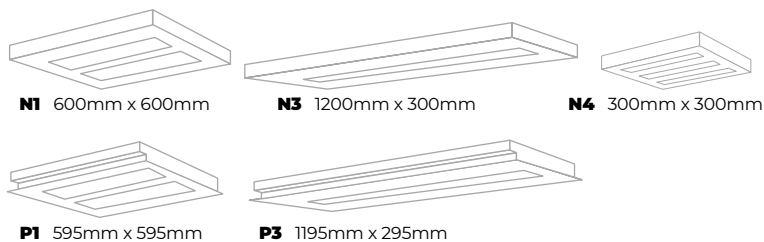

WYMIARY
SIZE



DWIE WERSJE OPTYKI
TWO VERSION
OF OPTIC SYSTEM



SOCZEWKA
LENS



SOCZEWKA
LENS



MARKOWE DIODY
I ZASILACZE
OSRAM/TRIDONIC
BRANDED LEDS AND
OSRAM/TRIDONIC DRIVERS

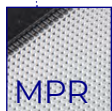

MIKROPRYZMATYCZNY
MICRO-
PRISMATIC



NOWA GENERACJA RASTRA
OGNIECZAJĄCA EFEKT OLSNIENIA
A NEW GENERATION OF RASTER
TO REDUCE THE GLARE

OPCJONALNIE
STEROWANIE DALI
I CASAMBI READY
DALI LED DRIVER
AVAILABLE AS AN OPTION
AND CASAMBI READY

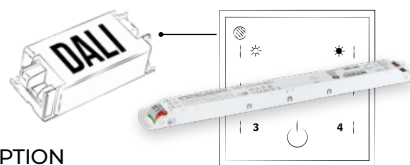

HIERRO LED

OPRAWA BIUROWA LED ▶ LED OFFICE FIXTURE



1/ HIERRO LED ... NT

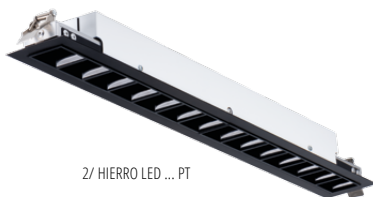

2/ HIERRO LED ... PT



3/ HIERRO LED ... NT + ALIN CORD + ROPE



4/ HIERRO LED ... NTFX



5/ HIERRO LED ... RM
6/ HIERRO LED ... RMFX



HIERRO to nowa rodzina opraw w ofercie Kanlux. Minimalistyczna i elegancka forma wpisuje się w najnowsze trendy architektonicznego designu. Stylowe rozwiązanie znajduje szerokie zastosowanie w nowoczesnych biurach, sklepach a także przestrzeniach typu loft jako oświetlenie podstawowe, uzupełniające lub akcentujące. Pełen obraz produktu dopełnia różnorodnie dostępnych sposobów sterowania. Pozwala to na tworzenie energooszczędnych i nowoczesnych systemów oświetleniowych, zapewniających atrakcyjne efekty świetlne.

5 lat Gwarancji na warunkach oświadczenia gwarancyjnego, dostępnego na stronie internetowej: www.kanlux.com

HIERRO is a new family of luminaires in the Kanlux range. Its minimalist and elegant form follows the latest trends in architectural design. The stylish solution is widely used in modern offices, shops and loft spaces as basic, additional or accent lighting. The product spectrum is made complete with a variety of control options. This makes it possible to implement energy-efficient and advanced lighting systems that provide attractive lighting effects.

5 years Warranty under the terms of the warranty statement, available on our website: www.kanlux.com

CONFIGURATOR



Wyprodukujemy dla Ciebie oprawę idealną. Stwórz ją z pomocą naszego konfiguratora.

We will produce a perfect luminaire for you. Create it with our configurator.

3 WYMIARY
3 SIZE



S 43x65x290mm



M 43x65x570mm



L 43x65x850mm

SZEŚĆ WERSJI
SIX VERSIONS

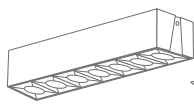

1/ NATYNKOWA
SURFACE
MOUNTED

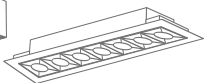

2/ PODTYNKOWA
RECESSED
MOUNTED

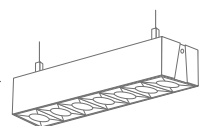

3/ NATYNKOWA
Z ZAWIESIAMI
SURFACE MOUNTED
WITH SLINGS

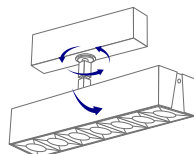

4/ NATYNKOWA FLEX
340° 90°
SURFACE MOUNTED
FLEX 340° 90°

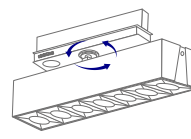

5/ MONTOWANE DO
SZYNOPRZEWODU
STANDARD 340°
RAIL MOUNTED
STANDARD 340°

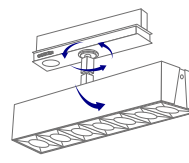

6/ MONTOWANE DO
SZYNOPRZEWODU
FLEX 340° 90°
RAIL MOUNTED
340° 90° FLEX



LEGENDA ► KEY

HR	HIERRO LED	
HRD	HIERRO LED DALI	
HRC	HIERRO LED CASAMBI READY	
WW/830	Ra≥80 3000K	
WN/835	Ra≥80 3500K	
NW/840	Ra≥80 4000K	
TW	wykonanie TUNABLE WHITE / TUNABLE WHITE (CCT)	
W	kolor obudowy: biały / housing white	
B	kolor obudowy: czarny / housing black	
NT	wersja natynkowa / surface	
PT	wersja podtynkowa / recessed	
HIERRO +ALIN CORD +ROPE	wersja wisząca / suspended mounted	
RM	wersja oprawy montowana do szynoprzewodu / rail mounted	
FX/FLEX	dodatkowa regulacja kąta (na indywidualne zamówienie) / additional angle adjustment (to individual order)	
S	długość 300mm / length 300mm	
M	długość 600mm / length 600mm	
L	długość 900mm / length 900mm	
SL	parametry / 9W 1250lm 300mm	wersja / version NT, PT, RM
SH	parametry / parameters 14W 1700lm 300mm	wersja / version NT, PT, RM
ML	parametry / parameters 18W 2450lm 600mm	wersja / version NT, PT
MM	parametry / parameters 23W 3000lm 600mm	wersja / version NT, PT, RM
MH	parametry / parameters 28W 3450lm 600mm	wersja / version NT, PT, RM
LL	parametry / parameters 23W 3150lm 900mm	wersja / version NT, PT, RM
LM	parametry / parameters 32W 4200lm 900mm	wersja / version NT, PT, RM
LH	parametry / parameters 42W 5150lm 900mm	wersja / version NT, PT, RM



WSZYSTKIE KODY OPRAW Z FABRYKI KANLUX ZNAJDZIESZ W KATALOGU FABRYKA KANLUX / ALL THE CODES OF KANLUX FACTORY FIXTURES YOU CAN FIND IN THE KANLUX FACTORY CATALOGUE



MARKOWE DIODY I ZASILACZE OSRAM /TRIDONIC BRANDED LEDS AND OSRAM /TRIDONIC DRIVERS

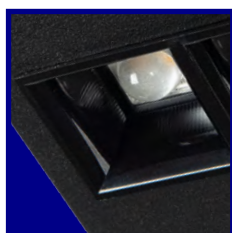

NOWA GENERACJA RASTRA OGRANICZAJĄCA EFEKT OLSNIENIA

A NEW GENERATION OF RASTER TO REDUCE THE GLARE

OPCJONALNIE STEROWANIE DALI I CASAMBI READY / DALI LED AND CASAMBI READY DRIVER AVAILABLE AS AN OPTION

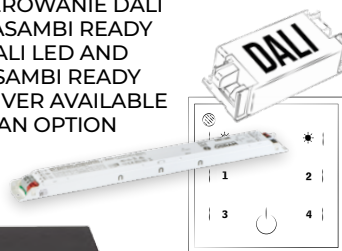

DWA KOLORY OBUDOWY I WERSJE MIX NA ZAMÓWIENIE TWO HOUSING COLOURS AND MIX VERSIONS TO INDIVIDUAL ORDER



BIAŁY WHITE



CZARNY BLACK



BIAŁO/ CZARNY WHITE/BLACK

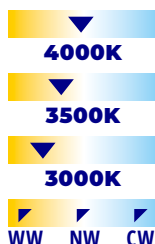

TRZY BARWY ŚWIATŁA I OPCJA WYKONANIA Z TUNABLE WHITE THREE COLOR TEMPERATURES AND OPTION WITH TUNABLE WHITE

DWIE WERSJE OPTYKI TWO VERSION OF OPTIC SYSTEM



SOCZEWKA LENS



LENS TO INDIVIDUAL ORDER



FUTURIO LED

OPRAWA PYŁOSZCZELNA LED ► LED DUSTPROOF LIGHTING FITTING



FACTORY



Kanlux FUTURIO LED to seria opraw hermetycznych, która produkowana jest w fabryce Kanlux. Wyróżnia je wysoka jakość wykonania oraz imponujące parametry. Kanlux FUTURIO LED to również szybki i łatwy montaż. Szeroka oferta modeli daje możliwość dopasowania oprawy do potrzeb każdej inwestycji. Dostępne są również wersje specjalistyczne: do zastosowania w wysokich temperaturach lub o wysokim strumieniu świetlnym.

5 lat Gwarancji na warunkach oświadczenia gwarancyjnego, dostępnego na stronie internetowej: www.kanlux.com

The Kanlux FUTURIO LED is a series of hermetic fixtures which is produced in the Kanlux factory. They are distinguished by high quality of workmanship and impressive parameters. The Kanlux FUTURIO LED is also quick and easy to install. A wide range of models affords the possibility to adjust the fixture to the needs of each investment. Specialist versions are also available: for high-temperature applications or with high luminous flux.

5 years Warranty under the terms of the warranty statement, available on our website: www.kanlux.com

CONFIGURATOR



Wyprodukujemy dla Ciebie oprawę idealną. Stwórz ją z pomocą naszego konfiguratora.

We will produce a perfect luminaire for you. Create it with our configurator.



MARKOWE DIODY I ZASILACZE OSRAM/TRIDONIC
BRANDED LEDS AND OSRAM/TRIDONIC DRIVERS



SZYBKA INSTALACJA
BEZ KONIECZNOŚCI
OTWIERANIA OPRAWY
EASY MOUNTING
WITHOUT THE
NECESSITY OF
OPENING
THE FIXTURE

MOŻLIWOŚĆ REGULACJI
ZA POMOCĄ UCHWYTÓW
MONTAŻOWYCH
ADJUSTABLE MOUNTING
BRACKET



MOŻLIWOŚĆ
ŁĄCZENIA W LINIE
POSSIBILITY OF
LINEAR CONNECTION



LEGENDA ► KEY

FT	FUTURIO LED
FTD	FUTURIO LED DALI
FTC	CASAMBI READY
26W - 73W	moc [W] / power [W]
840	Ra≥80 4000K
OPL	klosz opalowy / opal lamshade
RYF	klosz ze strukturą pryzmatyczną / prismatic structure lamshade
INT	soczewka wąskostromieniowa / narrow beam angle lens
ASY	soczewka asymetryczna / asymmetrical beam angle lens
FTHL	wersja specjalna o wysokim strumieniu świetlnym / special version with high lumen
FTHT	wersja specjalna do pracy w wyższych temperaturach / special version to work with high temperature
SCF	uproszczona opcja corridor function / simple option of the corridor function



WSZYSTKIE KODY OPRAW Z FABRYKI KANLUX ZNAJDZIESZ W KATALOGU FABRYKA KANLUX / ALL THE CODES OF KANLUX FACTORY FIXTURES YOU CAN FIND IN THE KANLUX FACTORY CATALOGUE



DWIE DŁUGOŚCI
TWO LENGTHS

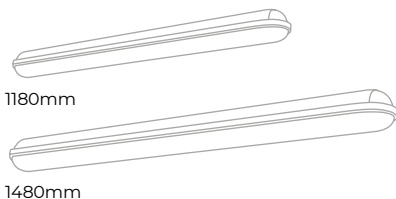

OPCJONALNIE STEROWANIE DALI I CASAMBI READY / DALI LED AND CASAMBI READY DRIVER AVAILABLE AS AN OPTION

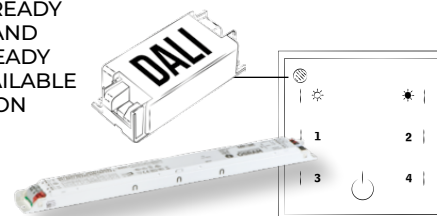

IP 65
IK 08



DWIE WERSJE Z SOCZEWKAMI
TWO MODELS WITH LENSES



WĄSKOSTROMIENIOWY NARROW BEAM ANGLE

ASYMETRYCZNY ASYMMETRIC BEAM ANGLE

DWA RODZAJE KLOSZY
TWO TYPES OF LAMP SHADES



ZE STRUKTURĄ PRYZMATYCZNĄ PRYSMATIC STRUCTURE

OPALOWY OPAL



Rodzina uniwersalnych adapterów ADTR to najszybszy sposób natynkowego montażu paneli oświetleniowych np. BRAVO, BLINGO. Monolityczna konstrukcja niewymagająca wcześniejszego skręcania oszczędza czas i zapewnia doskonały efekt wizualny za każdym razem i w każdych warunkach. Szeroka gama kształtów i wymiarów zapewnia pełną kompatybilność z 99,9% rozwiązań paneli LED edge oraz backlight obecnych na rynku.

A family of universal ADTR adapters is the fastest way to install surface-mounted lighting panels, e.g. BRAVO, BLINGO. Monolithic design that does not require bolting together beforehand saves time and provides a perfect visual effect every time and under any conditions. Wide range of shapes and sizes ensures full compatibility with 99,9% of LED edge and backlight panel solutions available in the market.

LEGENDA ▶ KEY

ADTR	adapter/adapter
ADTR-H	adapter wysoki / high adapter
ADTR-H 76MM	adapter wysoki 76mm / high adapter 76mm
ADTR-S	adapter SLIM / adapter SLIM
ADTR-S-H	adapter SLIM wysoki 76mm / adapter SLIM high 76mm
W	kolor obudowy: biały / housing colour: white
B	kolor obudowy: czarny / housing colour: black
S	kolor obudowy: srebrny / housing colour: silver

TRZY KSZTAŁTY
THREE SHAPES

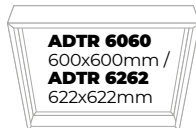

ADTR 12030 B	27614	5905339276148
ADTR 12030 SR	27612	5905339276124
ADTR 12030 W	27611	5905339276117
ADTR 3060 B	29842	5905339298423
ADTR 3060 SR	29841	5905339298416
ADTR 3060 W	29840	5905339298409
ADTR-H 3060 B	33394	5905339333940
ADTR-H 3060 SR	33395	5905339333957
ADTR-H 3060 W	33393	5905339333933
ADTR 6060 B	27615	5905339276155
ADTR 6060 SR	27610	5905339276100
ADTR 6060 W	27613	5905339276131
ADTR 6262 B	33430	5905339334305
ADTR 6262 SR	33431	5905339334312
ADTR 6262 W	33432	5905339334329
ADTR-H 12030 B	33391	5905339333919
ADTR-H 12030 SR	33392	5905339333926
ADTR-H 12030 W	33390	5905339333902
ADTR-H 6060 B	29845	5905339298454
ADTR-H 6060 SR	29844	5905339298447
ADTR-H 6060 W	29843	5905339298430
ADTR-H 6262 B	33433	5905339334336
ADTR-H 6262 SR	33434	5905339334343
ADTR-H 6262 W	33435	5905339334350
ADTR-H 76MM 6060 W	33398	5905339333988
ADTR-H 76MM 6262 B	33437	5905339334374
ADTR-H 76MM 6262 SR	33438	5905339334381
ADTR-H 76MM 6262 W	33436	5905339334367
ADTR-S 6060 W	27616	5905339276162
ADTR-S-H 6060 W	27617	5905339276179



Kanlux

ADTR

RAMKA NATYNKOWA ▶ SURFACE-MOUNTED FRAME

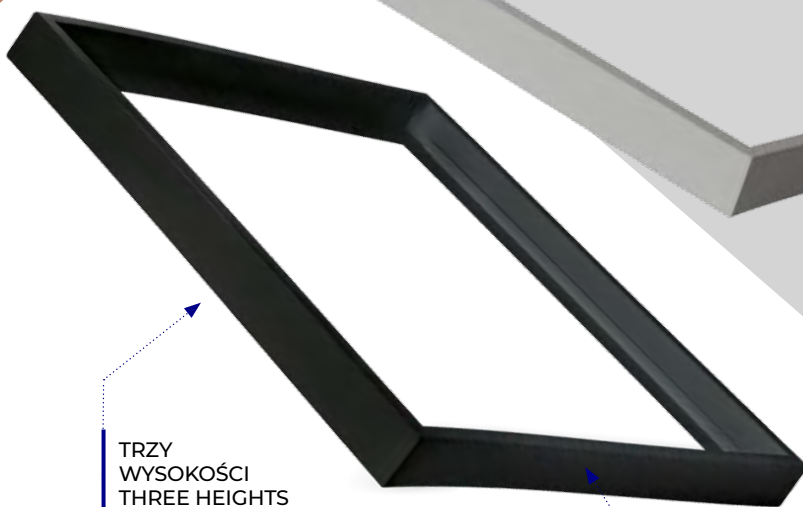
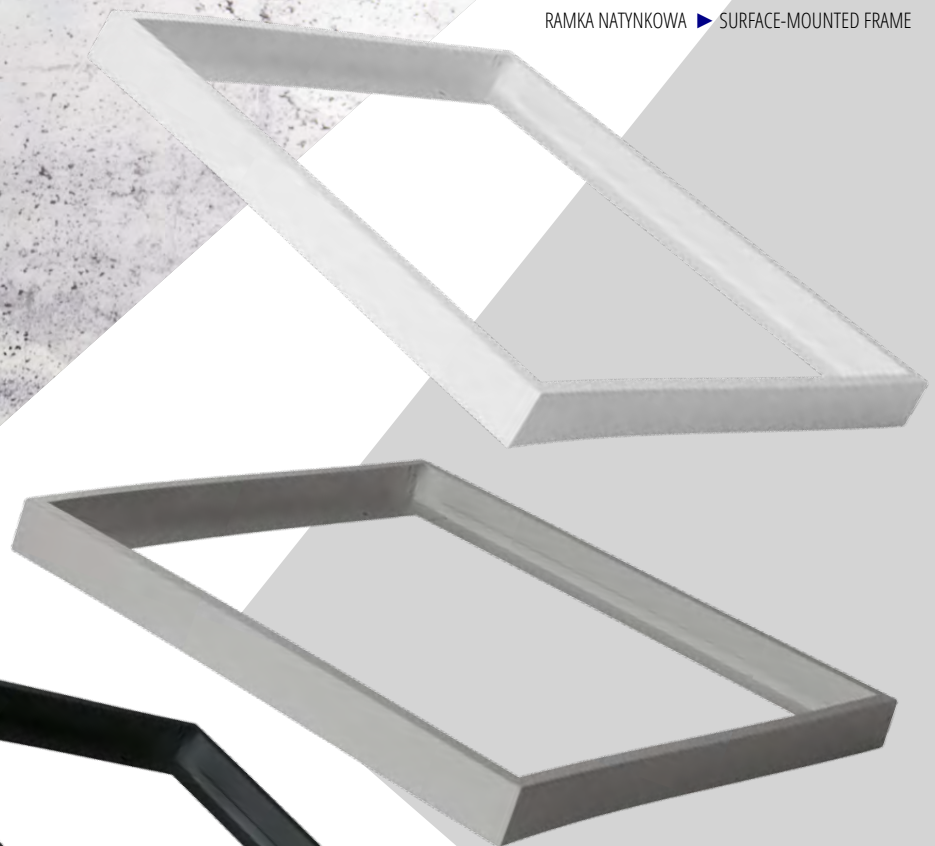

TRZY
WYSOKOŚCI
THREE HEIGHTS



ADTR
wysokość
45mm /
height
45mm



ADTR-H
wysokość
65mm /
height
65mm



ADTR-H 76MM
wysokość
76mm /
height
76mm

TRZY KOLORY
OBUDOWY
THREE HOUSING
COLORS



CZARNY
BLACK



BIAŁY
WHITE

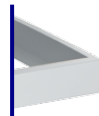

SREBRNY
SILVER

ESTETYKA
WYKONANIA
AESTHETICALLY MADE

BRAK DODATKOWYCH
ŁĄCZNIKÓW
I PLASTIKOWYCH
NAROŻNIKÓW
NO ADDITIONAL
CONNECTORS OR
PLASTIC CORNERS

WYSOKA SZTYWNOŚĆ
ORAZ GWARANCJA
ZACHOWANYCH KĄTÓW
HIGH STABILITY
AND GUARANTEED
CORRECT ANGLES

Kanlux FACTORY

Pozwól, że rozświetlimy
Twoją firmę

Kanlux FACTORY

Let us light up your
company





Kanlux
FACTORY
CONFIGURATOR

Dopasujemy światło
do Twoich potrzeb
We will match the light
with your needs

SAM SKONFIGURUJ IDEALNĄ OPRAWĘ
CONFIGURE THE PERFECT LUMINAIRE ON YOUR OWN



Kanlux **ALIN**



Kanlux **OFIS S**

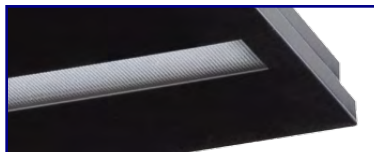

Kanlux **HIERRO**



Kanlux **FUTURIO**



Kanlux **ADTR**



DŁUGOŚĆ
LENGTH

KLOSZ
LAMP SHADE

TEMPERATURA BARWOWA
COLOR TEMPERATURE

MOC
POWER

KOLOR
COLOUR

SPOSÓB MONTAŻU
ASSEMBLY

Wyprodukujemy dla Ciebie
oprawę idealną. Stwórz ją
z pomocą naszego konfiguratora.

We will produce a perfect
luminaire for you. Create it
with our configurator.



Kanlux





ŹRÓDŁA ŚWIATŁA

LIGHT SOURCES

Zależy Ci na tym aby produkty, którymi się otaczasz były bezpieczne i trwałe.

Dbamy o to podczas produkcji i w naszym laboratorium Kanlux. Mamy pewność, że oddajemy w Twoje ręce produkt całkowicie bezpieczny i spełniający Twoje wymagania.

You want the products around you to be safe and durable. We take care of all of this it during the production and in our Kanlux laboratory.

We are sure that we give you a product that is completely safe and meets your requirements.



*dane fotometryczne znajdziesz na:
photometric data you can find on:*

► [kanlux.com](https://www.kanlux.com)

KANLUX SMART

ŹRÓDŁO ŚWIATŁA LED ► LED LIGHT SOURCE



S A60 7W E27 CCT



S A60 9W E27 RGB CCT



Nowoczesny dom to dom inteligentny i funkcjonalny. Żarówki z serii Kanlux SMART przeznaczone są właśnie do tego, aby każdy dom mógł taki być. Możesz sterować nimi poprzez mobilną aplikację, wykorzystując sieć Wi-Fi 2,4GHz lub Bluetooth. Żarówki Kanlux SMART posiadają funkcje: ściemniania, płynnej zmiany barwy światła (CCT) i koloru (RGB), który możesz wybrać z palety 16 milionów barw. Dzięki takim funkcjom jak harmonogramy, biorhythm czy łączenia w grupy z innymi urządzeniami SMART, z powodzeniem dostosujesz światło w domu do Twojego rytmu życia. Dla jeszcze większego komfortu użytkowania możesz sterować żarówkami Kanlux SMART za pomocą poleceń głosowych (Asystent Google / Alexa). Dowiedz się więcej o Kanlux SMART na www.kanluxsmart.com.

A modern home is a smart and functional home. The bulbs from the Kanlux SMART series are designed in such a way as to enable the transformation of every home into a modern one. You can control them through a mobile app, via Wi-Fi or Bluetooth. Kanlux SMART bulbs have the following functions: dimming, smooth change of light colour (CCT) and colour (RGB), which you can choose from a palette of 16 million colours. With features such as schedules, biorhythm and grouping with other SMART devices, you can successfully adjust the light in your home to your lifestyle. For even greater comfort of use, you can control Kanlux SMART bulbs by voice command (Google Assistant/Alexa). Learn more about Kanlux SMART on www.kanluxsmart.com

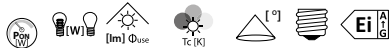

Model	Code	Power [W]	Beam angle [lm]	Temp [K]	Life [h]	Base	Code
S A60 7W E27 CCT	33640	5905339336408	7	60	806	2700-6500	320 E27 E
S A60 9W E27 RGB CCT	33641	5905339336415	9	60	806	2700-6500	180 E27 F
S A60 11,5W E27 RGB CCT	33642	5905339336422	11,5	75	1055	2700-6500	180 E27 F
S GU10 4,7W RGB CCT	33643	5905339336439	4,7	39	325	2700-6500	110 GU10 G
S C37 4,9W E14 RGB CCT	33644	5905339336446	4,9	40	470	2700-6500	180 E14 F



Steruj produktami Kanlux SMART za pomocą aplikacji mobilnej SMART LIFE

Control Kanlux SMART products with the SMART LIFE mobile application

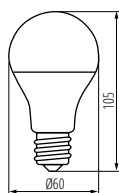

S A60 7W E27 CCT

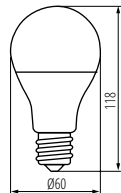

S A60 9W E27 RGB CCT

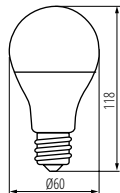

S A60 11,5W E27 RGB CCT

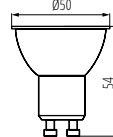

S GU10 4,7W RGB CCT

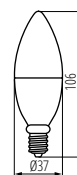

S C37 4,9W E14 RGB CCT

Kanlux

KANLUX SMART

ŹRÓDŁO ŚWIATŁA LED ► LED LIGHT SOURCE



S A60 7W E27 CCT



S A60 9W E27 RGB CCT



S A60 11,5W E27 RGB CCT



S GU10 4,7W RGB CCT



S C37 4,9W E14 RGB CCT



Możesz sterować oświetleniem w domu z wykorzystaniem głosu. Źródła Kanlux SMART współpracują z Amazon Alexa i Google Home.

You can control the lights in your home using your voice. Kanlux SMART sources work with Amazon Alexa and Google Home.

Funkcja „Biorytm” | „Biorhythm” function

Funkcja „Planu-harmonogramu” | „Plan-schedule” function

Funkcja „Odliczania” | „Countdown” function

Funkcja inteligentnego łączenia zdarzeń „Automatyzacja/Tap-to-Run” | Smart event connection function „Automation/Tap-to-Run”

Funkcja „Scen” | „Scenes” function

Źródła Kanlux SMART sterowane przez Wi-Fi 2.4GHz i Bluetooth

Kanlux SMART sources controlled via 2.4GHz Wi-Fi and Bluetooth



www.kanluxsmart.com

Kanlux IQ-LED LIFE

ŹRÓDŁO ŚWIATŁA LED ► LED LIGHT SOURCE



IQ-LED L G45 4,2W



IQ-LED L GU10 4,8W



Kanlux IQ-LED to bezpieczeństwo fotobiologiczne, korzystna dla oczu temperatura barwowa i niezawodność. Nowe modele LIFE to światło zbliżone do naturalnego. W produktach IQ-LED LIFE zredukowano ilość światła niebieskiego (LESS BLUE), co wpływa na samopoczucie i nastrój użytkownika, zachowując jednocześnie pełną funkcjonalność źródła światła. Żarówki Kanlux IQ-LED LIFE to wysokie odwzorowanie naturalnych barw (Ra90), a także pięcioletnia gwarancja. Kanlux IQ-LED LIFE to jeszcze lepsza jakość i komfort użytkowania.

5 lat Gwarancji na warunkach oświadczenia gwarancyjnego, dostępnego na stronie internetowej

Materiał klosza: tworzywo sztuczne

Kanlux IQ-LEDs ensure photobiological safety, have a colour temperature that is beneficial to the eyes and are reliable. The new LIFE models are close to natural light. IQ-LED LIFE products reduce the amount of blue light (LESS BLUE), which affects the mood and well-being of the user, while maintaining the full functionality of the light source. Kanlux IQ-LED LIFE lamps ensure accurate reproduction of natural colours (Ra90) and have a five-year warranty. Kanlux IQ-LED LIFE offers even better quality and comfort of use.

5 years Warranty under the terms of the warranty statement, available on our website
Lampshade material: plastic

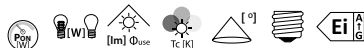

IQ-LED L G45 4,2W-WW	33760	5905339337603	4,2	40	470	2700	240	E14	E
IQ-LED L G45 4,2W-NW	33761	5905339337610	4,2	41	490	4000	240	E14	E
IQ-LED L A60 7,2W-WW	33762	5905339337627	7,2	60	806	2700	220	E27	E
IQ-LED L A60 7,2W-NW	33763	5905339337634	7,2	62	840	4000	220	E27	E
IQ-LED L GU10 4,8W-WW	33764	5905339337641	4,8	49	450	2700	100	GU10	E
IQ-LED L GU10 4,8W-NW	33765	5905339337658	4,8	49	450	4000	100	GU10	E

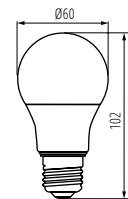

IQ-LED L A60 7,2W

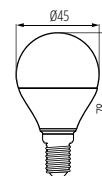

IQ-LED L G45 4,2W

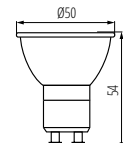

IQ-LED L GU10 4,8W

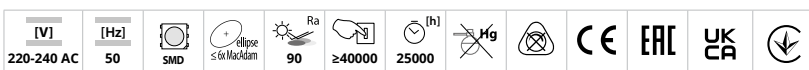

Kanlux

IQ-LED LIFE

ŹRÓDŁO ŚWIATŁA LED ► LED LIGHT SOURCE



IQ-LED L G45 4,2W



IQ-LED L A60 7,2W



IQ-LED L GU10 4,8W

Kanlux przeprowadza **REWOLUCJĘ** i daje Ci **NOWĄ JAKOŚĆ ŚWIATŁA!**

Kanlux is making a **REVOLUTION**
and gives you a **NEW QUALITY OF LIGHT!**



Kanlux

IQ-LED A60

ŹRÓDŁO ŚWIATŁA LED ► LED LIGHT SOURCE

NEW



IQ-LED A60 3,4W



IQ-LED A60 5,9W



IQ-LED A60 7,8W



IQ-LED A60 11W

			P _{use} (W)	[lm]	Φ _{use} [°]	T _c (K)	[°]	E27	E17
IQ-LED A60 3,4W-WW	36670	5905339366702	3,4	40	470	2700	180	E27	D
IQ-LED A60 3,4W-NW	36671	5905339366719	3,4	40	470	4000	180	E27	D
IQ-LED A60 3,4W-CW	36672	5905339366726	3,4	40	470	6500	180	E27	D
IQ-LED A60 5,9W-WW	36673	5905339366733	5,9	60	806	2700	180	E27	D
IQ-LED A60 5,9W-NW	36674	5905339366740	5,9	60	806	4000	180	E27	D
IQ-LED A60 5,9W-CW	36675	5905339366757	5,9	60	806	6500	180	E27	D
IQ-LED A60 7,8W-WW	36676	5905339366764	7,8	75	1055	2700	180	E27	D
IQ-LED A60 7,8W-NW	36677	5905339366771	7,8	75	1055	4000	180	E27	D
IQ-LED A60 7,8W-CW	36678	5905339366788	7,8	75	1055	6500	180	E27	D
IQ-LED A60 11W-WW	36679	5905339366795	11	100	1521	2700	180	E27	D
IQ-LED A60 11W-NW	36680	5905339366801	11	100	1521	4000	180	E27	D
IQ-LED A60 11W-CW	36681	5905339366818	11	100	1521	6500	180	E27	D

220-240 AC	50	SMD	360° Φ _{use}	ellipse ≤ 60 Maczkom	90	≥50000	25000					



Kanlux IQ-LED A60 to przyjazna oczom temperatura barwowa i niezawodność, a to wszystko zachowane w klasycznym designie A60. Nowe żarówki IQ-LED Kanlux to też wyjątkowa skuteczność świetlna, nawet do 138 lumenów z Wata, a za tym idzie mniejsze zużycie energii. IQ-LED Kanlux zapewniają pełen komfort użytkowania oraz bezpieczeństwo.

Materiał: tworzywo sztuczne

Materiał klosza: tworzywo sztuczne

Kanlux IQ-LED A60 provides an eye-friendly temperature of colour and reliability, and all this in the classic A60 design. The new IQ-LED bulbs by Kanlux also offer exceptional luminous efficacy, up to 138 Lumens per Watt, and as a result lower energy consumption. IQ-LEDs from Kanlux offer full comfort and safety.

Materiał: plastic

Lampshade material: plastic

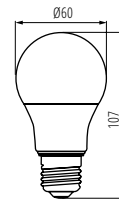

IQ-LED A60 3,4W

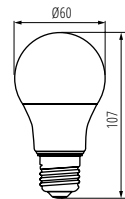

IQ-LED A60 5,9W

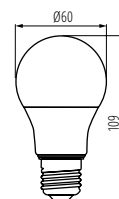

IQ-LED A60 7,8W

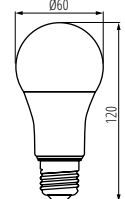

IQ-LED A60 11W

Kanlux

IQ-LED A67

ŹRÓDŁO ŚWIATEŁA LED ► LED LIGHT SOURCE



IQ-LED A67 N 19W-WW



IQ-LED A67 N 19W-NW



IQ-LED A67 N 19W-CW



Kanlux IQ-LED to bezpieczeństwo fotobiologiczne, przyjazna oczom temperatura barwowa i niezawodność, a to wszystko w nowej, dużej bańce A67. Żarówki Kanlux IQ-LED zapewniają pełen komfort użytkowania oraz bezpieczeństwo.

Materiał: tworzywo sztuczne

Materiał klosza: tworzywo sztuczne

Kanlux IQ-LED means photo-biological safety, colour temperature friendly to eyes and reliability and all this in a new, large bulb A67. IQ-LED bulbs ensure full comfort of use and safety.

Materiał: plastic

Lampshade material: plastic



Model	Code	Part No.	Power (W)	Lumen (lm)	Use (h)	Temp (K)	Beam angle [°]	Socket	Class
IQ-LED A67 N 19W-WW	33746	5905339337467	19	150	2452	2700	200	E27	E
IQ-LED A67 N 19W-NW	33747	5905339337474	19	150	2452	4000	200	E27	E
IQ-LED A67 N 19W-CW	33748	5905339337481	19	150	2452	6500	200	E27	E

[V]	[Hz]	SMD	360° Φ _{use}	360° Φ _{use}	Ra	≥40000	15000	Hg	RoHS	CE	EAC	UKA	Recycling
220-240 AC	50				80								

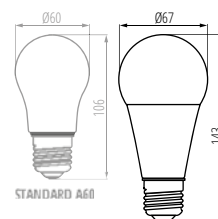

IQ-LED A67 N 19W

IQ-LEDDIM A60

ŹRÓDŁO ŚWIATŁA LED ► LED LIGHT SOURCE



IQ-LEDDIM A60 7,3W



IQ-LEDDIM A60 10,5W



IQ-LEDDIM A60 13,6W



Kanlux IQ-LED to bezpieczeństwo fotobiologiczne, przyjazna oczom temperatura barwowa i niezawodność. Teraz to wszystko w nowej wersji z trzonkiem E27 - dodatkowo wersja Kanlux IQ-LEDDIM współpracuje ze ściemniaczami. Żarówki Kanlux IQ-LED zapewniają pełen komfort użytkowania oraz bezpieczeństwo.

Materiał: tworzywo sztuczne

Materiał klosza: tworzywo sztuczne

Kanlux IQ-LED means photo-biological safety, colour temperature friendly to eyes and reliability. Now, all this in a new version with E27 light bulb base - additionally, the IQ-LEDDIM version cooperates with dimmers. IQ-LED bulbs ensure full comfort of use and safety.

Materiał: plastic

Lampshade material: plastic

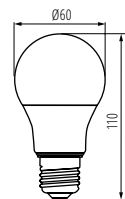

IQ-LEDDIM A60 7,3W; IQ-LEDDIM A60 10,5W

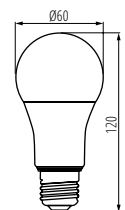

IQ-LEDDIM A60 13,6W



Model	Code	Part No.	Power (W)	Beam Angle (°)	Beam Diameter (mm)	Beam Diameter (cm)	Beam Diameter (in)	Base	Energy Efficiency Class
IQ-LEDDIM A60 7,3W-WW	33722	5905339337221	7,3	60	806	2700	220	E27	E
IQ-LEDDIM A60 7,3W-NW	33723	5905339337238	7,3	60	806	4000	220	E27	E
IQ-LEDDIM A60 10,5W-WW	33724	5905339337245	10,5	75	1060	2700	220	E27	F
IQ-LEDDIM A60 10,5W-NW	33725	5905339337252	10,5	75	1060	4000	220	E27	F
IQ-LEDDIM A60 13,6W-WW	33726	5905339337269	13,6	100	1521	2700	220	E27	E
IQ-LEDDIM A60 13,6W-NW	33727	5905339337276	13,6	100	1521	4000	220	E27	E

[V] 220-240 AC	[Hz] 50	SMD	360° Use	ellipse ≤ 60 MacAdam	Ra 80	≥40000	25000 [h]	Hg	RoHS	CE	ERC	UK	Down Arrow
-------------------	------------	-----	-------------	-------------------------	----------	--------	-----------	----	------	----	-----	----	------------

Kanlux

XLED EX A60

ŹRÓDŁO ŚWIATŁA LED ► LED LIGHT SOURCE

NEW



XLED EX A60 4W



XLED EX A60 5W



XLED EX A60 7,2W



Kolejna odsłona EXTREMALNIE wydajnych źródeł światła Kanlux XLED EX A60 to ponadprzeciętna skuteczność świetlna na poziomie 210 lumenów z Wata, która sprawia, że te żarówki LED są 15 razy wydajniejsze od swoich tradycyjnych, standardowych poprzedników (60W). 5 lat gwarancji, 50.000 godzin trwałości, 50.000 cykli włącz/wyłącz to ich kolejne zalety. Ponadto Kanlux XLED EX A60 posiadają szklaną bańkę i filamentowe „pręciki”, które upodabniają je do wolframowych żarówek, ale wykorzystują najnowsze osiągnięcia technologii LED.

5 lat Gwarancji na warunkach oświadczenia gwarancyjnego, dostępnego na stronie internetowej

Materiał klosza: szkło

The next edition of EXTREMELY efficient light sources Kanlux XLED EX A60. The above-average luminous efficiency of 210 lumens per watt makes these LED bulbs 15 times more efficient than their traditional, standard predecessors. 5-year warranty, 50,000 hours of durability, 50,000 on/off cycles are their other advantages. In addition, they have a glass bulb and filament "rods" that resemble tungsten bulbs, but use the latest achievements of LED technology.

5 years Warranty under the terms of the warranty statement, available on our website
Lampshade material: glass



Model	Code	Part No.	Wattage	Beam Angle	Lumen	Temp	Beam Diameter	Base	Energy Class
XLED EX A60 4W-WW	36243	5905339362438	4	62	840	2700	320	E27	A
XLED EX A60 4W-NW	36244	5905339362445	4	62	840	4000	320	E27	A
XLED EX A60 5W-WW	36245	5905339362452	5	75	1055	2700	320	E27	A
XLED EX A60 5W-NW	36246	5905339362469	5	75	1055	4000	320	E27	A
XLED EX A60 7,2W-WW	36247	5905339362476	7,2	100	1521	2700	320	E27	A
XLED EX A60 7,2W-NW	36248	5905339362483	7,2	100	1521	4000	320	E27	A

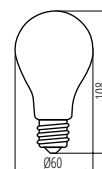

XLED EX A60

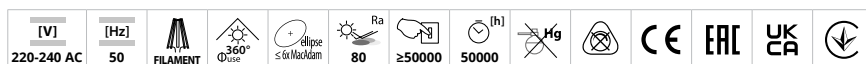

XLED A60

ŹRÓDŁO ŚWIATŁA LED ► LED LIGHT SOURCE



XLED A60 4,5W



XLED A60 7W



XLED A60 8W; 10W



Kanlux XLED łączy w sobie najlepsze cechy tradycyjnych żarówek i nowoczesnych źródeł światła LED. Dlatego mówimy o nim, że to pierwsza prawdziwa „żarówka LED”. Szklana bańka w kształcie tradycyjnej żarówki i diody LED rozmieszczone w taki sposób, że światło rozchodzi się we wszystkich kierunkach, a kąt świecenia wynosi nawet 320 stopni!

Materiał klosza: szkło

Kanlux XLED combines the best features of traditional bulbs and modern LED light sources. Therefore, we talk about it as the first real LED bulb. A glass bulb in the shape of a traditional bulb and LED diodes placed in such a way so that light can part in all directions, and the angle of light comes to even 320 degrees!

Lampshade material: glass



Model	Power (W)	Voltage (V)	Power Factor (PF)	Beam Angle (°)	Filament	Lifetime (h)	Energy Efficiency Class (Ei)			
XLED A60 4,5W-WW	29600	5905339296009	4,5	40	470	2700	320	E27	15000	F
XLED A60 7W-WW	29601	5905339296016	7	60	810	2700	320	E27	15000	E
XLED A60 7W-NW	29602	5905339296023	7	60	810	4000	320	E27	15000	E
XLED A60 7W-CW	29603	5905339296030	7	60	810	6500	320	E27	15000	E
XLED A60 8W-WW	29604	5905339296047	8	75	1055	2700	320	E27	15000	E
XLED A60 10W-WW	29605	5905339296054	10	99	1520	2700	320	E27	10000	D
XLED A60 10W-NW	29606	5905339296061	10	99	1520	4000	320	E27	10000	D

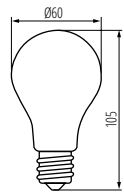

XLED A60 4,5W; XLED A60 7W;
XLED A60 8W; XLED A60 10W

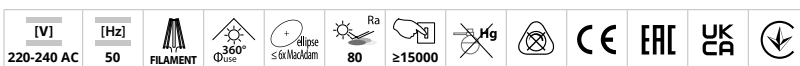

Kanlux

XLED A70

ŹRÓDŁO ŚWIATŁA LED ► LED LIGHT SOURCE



XLED A70 18W



Kanlux XLED łączy w sobie najlepsze cechy tradycyjnych żarówek i nowoczesnych źródeł światła LED. Dlatego mówimy o serii XLED, że to pierwsza prawdziwa „żarówka LED”. Szklana bańka A70 to ponadprzeciętny rozmiar w kształcie tradycyjnej żarówki, a diody LED rozmieszczone są wewnątrz w taki sposób, że światło rozchodzi się we wszystkich kierunkach.

Material klosza: szkło

Kanlux XLED combines the best features of traditional bulbs and modern LED light sources. Therefore, we talk about it as the first real “LED bulb”. A70 glass bulb has extraordinary size in the shape of a traditional bulb and LED diodes are arranged inside in such a way so that light can part in all directions.

Lampshade material: glass



XLED A70 18W-WW	29648	5905339296481	18	149	2450	2700	320	E27	D
XLED A70 18W-NW	29649	5905339296498	18	149	2450	4000	320	E27	D

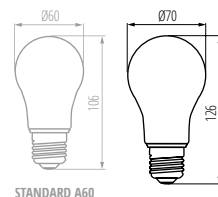
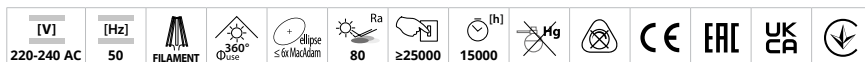

XLED A70 18W

XLED A60M

ŹRÓDŁO ŚWIATŁA LED ► LED LIGHT SOURCE



XLED A60M 4,5W, XLED A60M 7W,
XLED A60M 8W, XLED A60M 10W



Kanlux XLED łączy w sobie najlepsze cechy tradycyjnych żarówek i nowoczesnych źródeł światła LED. Matowa bańka w kształcie tradycyjnej żarówki i diody LED rozmieszczone w taki sposób, że światło rozchodzi się we wszystkich kierunkach, a kąt świecenia wynosi nawet 320 stopni!

Materiał klosza: szkło

Kanlux XLED combines the best features of traditional bulbs and modern LED light sources. A matt bulb in the shape of a traditional bulb and LED diodes placed in such a way so that light can part in all directions, and the angle of light comes to even 320 degrees!

Lampshade material: glass



	Power (W)	Voltage (V)	Beam angle (°)	Color temperature (K)	Beam diameter (mm)	Base diameter (mm)	Lifetime (h)	Energy efficiency class (A-G)
XLED A60 4,5W-WW-M	29607	5905339296078	4,5	40	470	2700	320	E27 15000 F
XLED A60 4,5W-NW-M	29608	5905339296085	4,5	40	470	4000	320	E27 15000 F
XLED A60 7W-WW-M	29609	5905339296092	7	60	810	2700	320	E27 15000 E
XLED A60 7W-NW-M	29610	5905339296108	7	60	810	4000	320	E27 15000 E
XLED A60 8W-WW-M	29612	5905339296122	8	75	1055	2700	320	E27 15000 E
XLED A60 8W-NW-M	29613	5905339296139	8	75	1055	4000	320	E27 15000 E
XLED A60 10W-WW-M	29615	5905339296153	10	99	1520	2700	320	E27 10000 D
XLED A60 10W-NW-M	29616	5905339296160	10	99	1520	4000	320	E27 10000 D

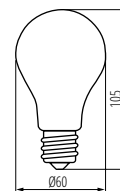

XLED A60M 4,5W, XLED A60M 7W,
XLED A60M 8W, XLED A60M 10W

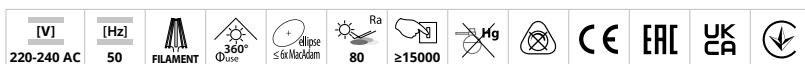

Kanlux

XLED STEPDIM

ŹRÓDŁO ŚWIATŁA LED ► LED LIGHT SOURCE



XLED A60 7W-STEPPDIM



XLEDA60 7W-WW-STEPPDIM	29634	5905339296344	max 7	60	max 810	2700	320	E27	E
XLEDA60 7W-NW-STEPPDIM	29635	5905339296351	max 7	60	max 810	4000	320	E27	E

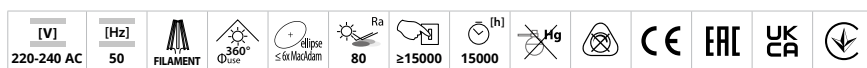

STEP DIMMING function

- 1x CLICK 100% power
- 2x CLICK 50% power
- 3x CLICK 7% power
- 2x CLICK RESET 100% power
- <0,5s



Kanlux XLED łączy w sobie najlepsze cechy tradycyjnych żarówek i nowoczesnych źródeł światła LED. Dlatego mówimy o nim, że to pierwsza prawdziwa „żarówka LED”. Szklana bańka w kształcie tradycyjnej żarówki i diody LED rozmieszczone w taki sposób, że światło rozchodzi się we wszystkich kierunkach. Dodatkowo w wersji STEPDIM możemy zmniejszać stopniowo strumień świetlny bez dodatkowego ściemniacza.

Material klosza: szkło

Kanlux XLED combines the best features of traditional bulbs and modern LED light sources. Therefore, we talk about it as the first real LED bulb. A glass bulb in the shape of a traditional bulb and LED diodes placed in such a way so that light can part in all directions. Additionally, in the STEPDIM version you can gradually reduce the light stream without an additional dimmer.

Lampshade material: glass

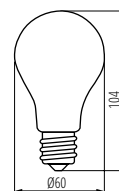

XLED A60 7W-STEPPDIM

Kanlux

XLEDIM A60

ŹRÓDŁO ŚWIATŁA LED ► LED LIGHT SOURCE

NEW



XLEDIM A60 E27 11W



XLEDIM A60 E27 11W-WW	37240	5905339372406	11	100	1521	2700	320	E27	D
XLEDIM A60 E27 11W-NW	37241	5905339372413	11	100	1521	4000	320	E27	D
XLEDIM A60 E27 11W-CW	37242	5905339372420	11	100	1521	6500	320	E27	D

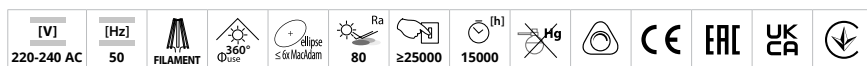

Kanlux XLEDIM A60 to duża moc świetlna zamknięta w tradycyjnym kształcie żarówki. Dodatkowo Kanlux XLEDIM A60 to dekoracyjny filament, który świetnie będzie wyglądał w odkrytych lampach. Żarówki Kanlux XLEDIM A60 o mocy 11W dają światło odpowiadające tradycyjnym żarówkom 100W (1520lm) i współpracują ze ściemniaczami. Ponadto zapewniają pełen komfort użytkowania oraz bezpieczeństwo, które potwierdzają testy w Laboratorium Kanlux.

Material klosza: szkło

Kanlux XLEDIM A60 has high light output in a traditional bulb shape. Additionally, Kanlux XLEDIM A60 is a decorative filament that will look great in outdoor lamps. Kanlux XLEDIM A60 11W bulbs provide light equivalent to traditional 100W bulbs (1520lm) and work with dimmers. Moreover, they ensure full comfort of use and safety, which is confirmed by tests at the Kanlux Laboratory.

Lampshade material: glass

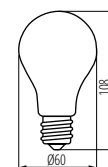

XLEDIM A60 E27 11W

Kanlux

XLED A60 B22

ŹRÓDŁO ŚWIATŁA LED ► LED LIGHT SOURCE



XLED A60 B22



XLED A60M B22-M



Model	Power [W]	Code	Power [W]	Beam angle [°]	Temp [K]	Beam angle [°]	Temp [K]	Beam angle [°]	Temp [K]	Temp [K]	Temp [K]	Temp [K]	Temp [K]	Temp [K]	Temp [K]	Temp [K]	Temp [K]	Temp [K]	Temp [K]
XLED A60 B22 7W-WW	33100	5905339331007	7	60	810	2700	320	B22	15000	E									
XLED A60 B22 7W-WW-M	33102	5905339331021	7	60	810	2700	320	B22	15000	E									
XLED A60 B22 7W-CW-M	33103	5905339331038	7	60	810	6500	320	B22	15000	E									
XLED A60 B22 10W-WW-M	33108	5905339331083	10	99	1520	2700	320	B22	10000	D									
XLED A60 B22 10W-CW-M	33109	5905339331090	10	99	1520	6500	320	B22	10000	D									

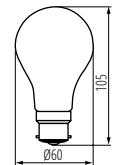
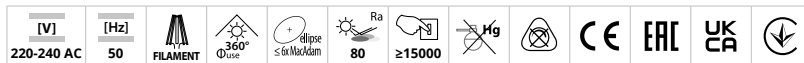

XLED A60 B22



Kanlux XLED A60 B22 M łączy w sobie najlepsze cechy tradycyjnych żarówek i nowoczesnych źródeł światła LED. Matowa bańka w kształcie tradycyjnej żarówki i diody LED rozmieszczone w taki sposób, że światło rozchodzi się we wszystkich kierunkach, a kąt świecenia wynosi nawet 320 stopni! Żarówki XLED A60 B22 M posiadają gwint B22.

Lampshade material: szkło

Kanlux XLED A60 B22 M combines the best features of traditional light bulbs and modern LED light sources. Matte bulb in the shape of a traditional light bulb and LED diodes arranged in such a way that the light spreads in all directions, and the beam angle is even 320 degrees! XLED A60 B22 M bulbs have a B22 cap.

Lampshade material: glass

Kanlux

XLEDIM A60 B22

ŹRÓDŁO ŚWIATŁA LED ► LED LIGHT SOURCE



XLEDIM A60 B22 12W

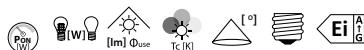

Model	Power [W]	Code	Power [W]	Beam angle [°]	Temp [K]	Beam angle [°]	Temp [K]	Beam angle [°]	Temp [K]	Temp [K]	Temp [K]	Temp [K]	Temp [K]	Temp [K]	Temp [K]	Temp [K]	Temp [K]	Temp [K]	
XLEDIM A60 B22 12W-WW	37243	5905339372437	12	100	1521	2700	320	B22	E										
XLEDIM A60 B22 12W-CW	37244	5905339372444	12	100	1521	6500	320	B22	E										

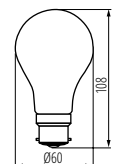

XLEDIM A60 B22 12W



Kanlux XLEDIM A60 B22 to duża moc świetlna zamknięta w tradycyjnym kształcie żarówki. Dodatkowo Kanlux XLEDIM A60 to dekoracyjny filament, który świetnie będzie wyglądał w odkrytych lampach. Żarówki Kanlux XLEDIM A60 o mocy 12W dają światło odpowiadające tradycyjnym żarówkom 100W (1520lm) i współpracują ze ściemniaczami. Źródła oznaczone symbolem B22 wyposażone są w trzonek B22.

Lampshade material: szkło

Kanlux XLEDIM A60 B22 is high luminous power enclosed in a traditional bulb shape. In addition, Kanlux XLEDIM A60 is a decorative filament that will look wonderful in exposed lamps. Kanlux XLEDIM A60 bulbs of 12W produce light equivalent to traditional 100W incandescent bulbs (1520lm) and are compatible with dimmers. Sources marked B22 are fitted with a B22 cap.

Lampshade material: glass

ST45 LED

ŹRÓDŁO ŚWIATŁA LED ► LED LIGHT SOURCE



ST45 LED 0,5W



ST45 LED 0,9W E27-RE



ST45 LED 0,9W E27-GR



ST45 LED 0,9W E27-BL



Kanlux ST45 LED to bańka wykonana z tworzywa sztucznego, która zapewni wyjątkową odporność na stłuczenia w warunkach zewnętrznych. Jest doskonałym uzupełnieniem girlandy świetlnej, ale sprawdzi się także w takich oprawach ogrodowych jak na przykład Kanlux VIMO, a także do oświetlenia werand, tarasów, altan ogrodowych czy ogródków restauracyjnych. ST45 LED mają trzonek E27 i są wyjątkowo oszczędne w eksploatacji. Są dostępne w barwie ciepłej białej i neutralnej białej, a także w kilku wybranych kolorach (czerwony, zielony, niebieski).

Materiał klosza: tworzywo sztuczne

Kanlux ST45 LED is a plastic bulb that provides exceptional resistance to breakage in outdoor conditions. It is the perfect accessory for a light garland, but will also work well with garden luminaires such as Kanlux VIMO, for example, and for lighting verandas, terraces, garden gazebos or restaurant gardens. ST45 LEDs have an E27 cap and are outstandingly economical in use. They come in warm white and neutral white, as well as a few selected colours (red, green, blue).

Lampshade material: plastic



ST45 LED 0,5W E27-WW	26045	5905339260451	0,5	50	ciepłobiała warm white	220	E27
ST45 LED 0,5W E27-NW	26046	5905339260468	0,5	50	biała white	220	E27
ST45 LED 0,9W E27-BL	26039	5905339260390	0,9	8	niebieska blue	220	E27
ST45 LED 0,9W E27-GR	26048	5905339260482	0,9	75	zielona green	220	E27
ST45 LED 0,9W E27-RE	26049	5905339260499	0,9	20	czerwona red	220	E27

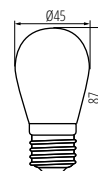
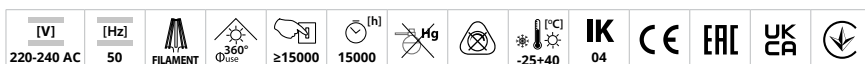

ST45 LED E27

Kanlux

ST64 A

ŹRÓDŁO ŚWIATŁA LED ► LED LIGHT SOURCE



ST64 A 4W-SW



ST64 A 4W-SW	26047	5905339260475	4	20	200	1800	E27
--------------	-------	---------------	---	----	-----	------	-----

[V]	[Hz]	FILAMENT	360° Φ _{use}	Ra	≥15000	25000	[h]	Hg	CE	EAC	UK	CA	↓
220-240 AC	50			80									



DECO
RI
function

1800K
SUPER
WARM

unique
LIGHT
effect



Kanlux ST64 A to wybitnie dekoracyjna żarówka LED o bardzo ciepłej barwie światła (1800K). Wzrost dekoracyjny stanowi zarówno „LEDowy żarnik” i bursztynowe szkło, ale także sam pierścień przy trzonku tego źródła światła. Przy jego pomocy wyczarujemy ciepłą, sprzyjającą odpoczynkowi atmosferę.

Materiał klosza: szkło

Kanlux ST64 A is an exceptionally decorative LED bulb with a very warm light color (1800K). The decorative value is both the “LED filament” and amber glass, but also the ring itself at the base of this light source. With its help, we will create a warm atmosphere conducive to relaxation.

Lampshade material: glass



ST64 A 4W-SW

Kanlux

XLED ST64

ŹRÓDŁO ŚWIATŁA LED ► LED LIGHT SOURCE



XLED ST64-7W



XLED ST64C 7W



XLED ST64 7W-WW	29637	5905339296375	7	55	725	2700	320	E27	F
XLED ST64C 7W-NW	33513	5905339335135	7	60	806	4000	320	E27	E

[V]	[Hz]	FILAMENT	360° Φ _{use}	Ra	≥15000	15000	[h]	Hg	CE	EAC	UK	CA	↓
220-240 AC	50			80									



320°

HIGH
lumen

FILA
MENT
LED

Kanlux XLED ST64 łączy w sobie najlepsze cechy tradycyjnych żarówek i nowoczesnych źródeł światła LED. Diody LED rozmieszczone są w taki sposób, że światło rozchodzi się we wszystkich kierunkach. Dodatkowo wersję Kanlux XLED ST64 cechuje nietypowy kształt, który wyróżni się w otwartych kloszach i doda dekoracyjności każdemu wnętrzu. Kanlux XLED ST64 to bursztynowy kolor bańki dla podkreślenia ciepłej barwy światła, a ST64C ma ją przezroczystą.

Materiał klosza: szkło

Kanlux XLED ST64 combines the best features of traditional bulbs and modern LED light sources. The LEDs are arranged in such a way that light spreads in all directions. In addition, Kanlux XLED ST64 version has an unusual shape that will stand out in open lampshades and add decorativeness to any interior. Kanlux XLED ST64 is an amber coloured bulb emphasising the warm colour of the light, while ST64C has a transparent bulb.

Lampshade material: glass

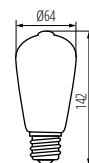

XLED ST64 7W

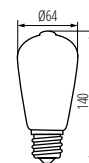

XLED ST64C 7W

Kanlux

XLED A60 MIRROR

ŹRÓDŁO ŚWIATŁA LED ► LED LIGHT SOURCE



XLED A60 M 7W



Wyjątkowe, ozdobne żarówki Kanlux XLED MIRROR to światło ozdobione srebrnym połyskiem. Część bańki to powłoka lustrzana, która doskonale wkomponuje się jako dodatek do nowoczesnych aranżacji. Światło w Kanlux XLED MIRROR odbijane jest do góry za pomocą warstwy refleksyjnej, co zapewnia mniej bezpośredniego światła i tworzy przytulną atmosferę. Doskonale sprawdzi się w lampach z odkrytą żarówką jako dodatkowa dekoracja lub w lampach z kloszem, gdzie osiągniemy efekt przytłumionego, nastrojowego światła.

Materiał: szkło

Exceptional, decorative bulbs Kanlux XLED MIRROR provide decorative silver light. Part of the bubble is a mirror coating that will blend in perfectly as an addition to modern designs. The light in Kanlux XLED MIRROR is reflected upwards with a reflective layer, providing less direct light and creating a cosy atmosphere. It is perfect for lamps with an exposed bulb as an additional decoration or for lamps with a lampshade, where we can achieve the effect of subdued, romantic light.

Materiał: glass



XLED A60 M 7W-WW	33514	5905339335142	7	52	680	2700	150	E27	F
XLED A60 M 7W-NW	33515	5905339335159	7	52	680	4000	150	E27	F

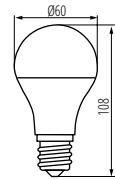
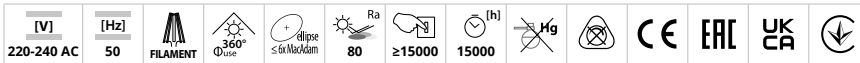

XLED A60 M 7W

Kanlux

XLED G95

ŹRÓDŁO ŚWIATŁA LED ► LED LIGHT SOURCE



XLED G95 7W-WW



XLED G95S 5,8W-NW



Kanlux XLED to nie tylko najlepsze parametry świetlne, ale również dodatkowa dekoracyjność. Żarówki Kanlux XLED G95 to duża, okrągła, szklana bańka i szeroki kąt świecenia. Kanlux XLED G95 bardzo efektywnie prezentują się w otwartych lampach i kinkietach, a także w zwisach bez klosza. Na szczególną uwagę zasługuje model XLED G95S z ciemnym, dymionym szkłem, to niezwykle dekoracyjne, ale i bardzo eleganckie źródło światła.

Materiał klosza: szkło

Kanlux XLED means not only the best lighting parameters, but also additional decorativeness. Kanlux XLED G95 bulbs are a large, round, glass bulb and a wide beam angle. Kanlux XLED G95 look very impressive in open lamps and wall lamps, as well as in overhangs without a shade. It is worth paying attention to the XLED G95S model with dark, smoked glass, it is an extremely decorative, but also very elegant light source.

Lampshade material: glass



XLED G95 7W-WW	36241	5905339362414	7	55	725	2500	320	E27	F
XLED G95S 5,8W-NW	36242	5905339362421	5,8	40	470	4000	320	E27	G

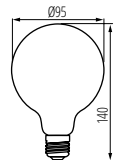
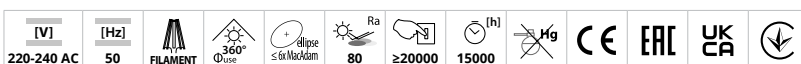

XLED G95

Kanlux XLED G125

ŹRÓDŁO ŚWIATŁA LED ► LED LIGHT SOURCE



XLED G125 7W

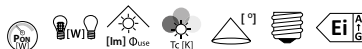

XLED G125 7W-WW	29638	5905339296382	7	55	725	2700	320	E27	F
-----------------	--------------	---------------	---	----	-----	------	-----	-----	---

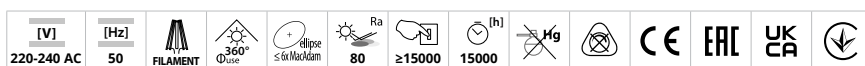

Kanlux XLED to nie tylko najlepsze parametry świetlne, ale również dodatkowa dekoracyjność. Żarówki Kanlux XLED G125 to duża okrągła szklana bańka i szeroki kąt świecenia. Kanlux XLED G125 bardzo przyjemnie prezentują się w otwartych lampach i kinkietach, a także w zwisach bez klosza.

Materiał klosza: szkło

Kanlux XLED does not only mean the best lighting parameters, but also additional decorativeness. Kanlux XLED G125 bulbs are a large round glass bulb and a wide angle of light. Kanlux XLED G125 look very pleasant in open lamps and wall lamps as well as in sags without a shade.

Lampshade material: glass

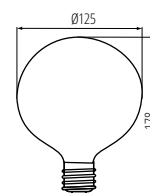

XLED G125 7W

Kanlux XLED G125

ŹRÓDŁO ŚWIATŁA LED ► LED LIGHT SOURCE



XLED G125 11W



XLED G125 11W-WW	33511	5905339335111	11	99	1520	2700	320	E27	D
XLED G125 11W-NW	33512	5905339335128	11	99	1520	4000	320	E27	D

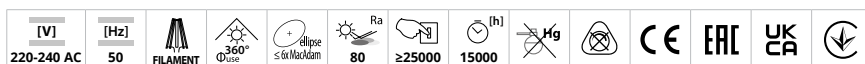

Kanlux XLED GLOBE to duże źródła światła o dekoracyjnym charakterze. Świetnie prezentują się w otwartych oprawach lub w zwisach, przy których nie stosujemy klosza. Źródła Kanlux XLED GLOBE mają bardzo wysoką skuteczność świetlną i szeroki kąt świecenia (320 stopni), dlatego też mogą skutecznie pojedynczo oświetlić pomieszczenie.

Materiał klosza: szkło

Kanlux XLED GLOBE are large, decorative light sources. They look great in open luminaires or in pendants with no lampshades. Kanlux XLED GLOBE sources have a very high luminous efficacy and a wide beam angle (320 degrees), so a single light source can effectively illuminate a room.

Lampshade material: glass

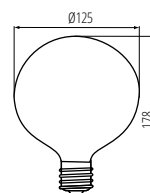

XLED G125 11W



XLED A60 4W-SW



XLED C35T 2,5W-SW



XLED ST64 4W-SW

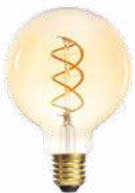

XLED G95 4W-SW



XLED G125 4W-SW



**1800K
SUPER
WARM**

320°

**DE
CO
RI**
function

Źródła światła Kanlux XLED w wyjątkowej, dekoracyjnej wersji pomogą Ci wykreować przytulną atmosferę. Wszystko dzięki bardzo ciepłej barwie światła zamkniętej w bursztynowym szkłe i spiralnemu filamentowi LED. Te LEDowe żarówki staną się ozdobą twojego domu, kawiarni, restauracji czy każdego innego miejsca. To wyjątkowe połączenie dekoracyjności i nowoczesnej, energooszczędnej technologii LED.

Materiał klosza: szkło

Kanlux XLED light sources in a unique, decorative version will help you create a cozy atmosphere. All thanks to a very warm color of light enclosed in amber glass and a spiral LED filament. These LED bulbs will decorate your home, cafe, restaurant or any other place. It is a unique combination of decorativeness and modern, energy-saving LED technology.

Lampshade material: glass



Model	Code	Part No.	Power [W]	Life [h]	Temp [K]	Beam [°]	Light [lm]	Power [W]	Temp [K]
XLED C35T 2,5W-SW	29641	5905339296412	2,5	15	135	1800	320	≥15000	E14
XLED A60 4W-SW	33516	5905339335166	4	25	250	1800	320	≥20000	E27
XLED ST64 4W-SW	33517	5905339335173	4	25	250	1800	320	≥25000	E27
XLED G95 4W-SW	33518	5905339335180	4	25	250	1800	320	≥20000	E27
XLED G125 4W-SW	33519	5905339335197	4	25	250	1800	320	≥20000	E27

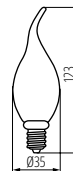
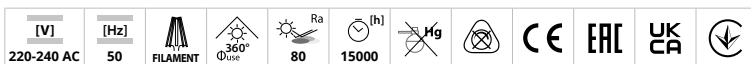

XLED C35T 2,5W-SW

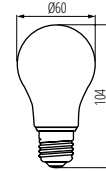

XLED A60 4W-SW

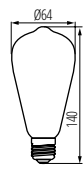

XLED ST64 4W-SW



XLED G95 4W-SW

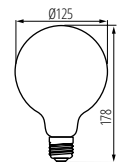

XLED G125 4W-SW

Kanlux

XLED W

ŹRÓDŁO ŚWIATEŁA LED ► LED LIGHT SOURCE

NEW



XLED W A60 8,5W-WW



XLED W ST64 7W-WW



XLED W C35E14 4,5W-WW



XLED W G45E14 4,5W-WW



WHITE
LED
FILA
MENT

DE
CO
RI
function

320

Szklane żarówki Kanlux XLED W mają klasyczny kształt i styl, ale zawierają dyskretny, biały filament, który jest nowością. Zyskujesz tu energooszczędność diod LED, ale żółte filamenty zostały zastąpione białą. Minimalistyczny XLED W prezentuje się wyjątkowo dekoracyjnie w trybie kiedy jest włączony jak i wyłączony. Z wyjątkowego białego filamentu uzyskujemy ciepłą temperaturę barwową 2700K. Kanlux XLED W dostępne są w popularnych kształtach: tradycyjnym, kulki, świeczki i ST64.

Materiał klosza: szkło

The Kanlux XLED W glass bulbs have a classic shape and style while incorporating a discreet white filament, which is a novelty. What you gain is the energy efficiency of LEDs but the yellow filaments have been replaced with white ones. The minimalist XLED W looks remarkably decorative in both on and off mode. The unique white filament produces a warm colour temperature of 2700K. Kanlux XLED W comes in popular shapes: traditional, ball, candle and ST64.

Lampshade material: glass

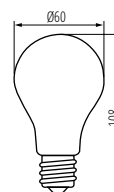

XLED W A60 8,5W-WW



XLED W ST64 7W-WW



XLED W C35E14 4,5W-WW

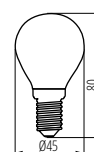

XLED W G45E14 4,5W-WW

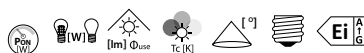

XLED W A60 8,5W-WW	37380	5905339373809	8,5	75	1055	2700	320	E27	E
XLED W ST64 7W-WW	37381	5905339373816	7	60	806	2700	320	E27	E
XLED W C35E14 4,5W-WW	37382	5905339373823	4,5	40	470	2700	320	E14	F
XLED W G45E14 4,5W-WW	37383	5905339373830	4,5	40	470	2700	320	E14	F



Kanlux

IQ-LED C35

ŹRÓDŁO ŚWIATŁA LED ► LED LIGHT SOURCE

NEW



IQ-LED C35E14 3,4W



IQ-LED C35E14 3,4W



IQ-LED C35E14 5,9W



Kanlux IQ-LED A35 E14 to przyjazna oczom temperatura barwowa i niezawodność, a to wszystko zachowane w klasycznym designie świeczki. Nowe żarówki IQ-LED Kanlux to też wyjątkowa skuteczność świetlna, nawet do 138 lumenów z Wata, a za tym idzie mniejsze zużycie energii. IQ-LED Kanlux zapewniają pełen komfort użytkowania oraz bezpieczeństwo.

Materiał: tworzywo sztuczne

Materiał klosza: tworzywo sztuczne

Kanlux IQ-LED A35 E14 provides an eye-friendly temperature of colour and reliability, and all this in the classic "candle" design. The new IQ-LED bulbs by Kanlux also offer exceptional luminous efficacy, up to 138 Lumens per Watt, and as a result lower energy consumption. IQ-LEDs from Kanlux offer full comfort and safety.

Materiał: plastic

Lampshade material: plastic



Model	Code	Part No.	Power [W]	Beam Angle [°]	Luminous Flux [lm]	Beam Diameter [mm]	Temp [K]	Beam Diameter [mm]	Base	Energy Efficiency
IQ-LED C35E14 3,4W-WW	36682	5905339366825	3,4	40	470	2700	240	E14	D	
IQ-LED C35E14 3,4W-NW	36683	5905339366832	3,4	40	470	4000	240	E14	D	
IQ-LED C35E14 3,4W-CW	36684	5905339366849	3,4	40	470	6500	240	E14	D	
IQ-LED C35E14 5,9W-WW	36685	5905339366856	5,9	60	806	2700	240	E14	D	
IQ-LED C35E14 5,9W-NW	36686	5905339366863	5,9	60	806	4000	240	E14	D	
IQ-LED C35E14 5,9W-CW	36687	5905339366870	5,9	60	806	6500	240	E14	D	

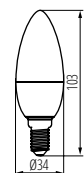

IQ-LED C35E14

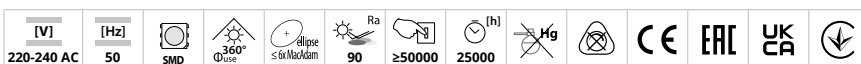

Kanlux XLEDEX C35

ŹRÓDŁO ŚWIATŁA LED ► LED LIGHT SOURCE

NEW



XLEDEX C35E14 3,8W



XLEDEX C35E14 3,8W-WW	37340	5905339373403	3,8	60	806	2700	320	E14	A
XLEDEX C35E14 3,8W-NW	37341	5905339373410	3,8	60	806	4000	320	E14	A

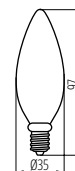
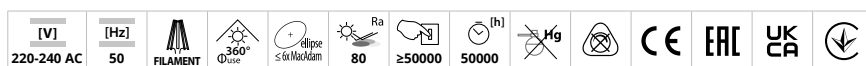

XLED EX C35E14 3,8W



EXTREMALNIE wydajne źródła światła Kanlux XLED EX C35 3,8W są odpowiednikiem żarówek 60W. Ponadprzeciętna skuteczność świetlna (210 lumenów z Wata) sprawia, że te źródła światła są 15 razy wydajniejsze od swoich tradycyjnych, standardowych poprzedników. 5 lat gwarancji, 50.000 godzin trwałości, 50.000 cykli włącz/wyłącz to ich kolejne zalety. Ponadto Kanlux XLED EX C35 posiadają szklaną bańkę i filamentowe „pręciki”, które upodobniają ją do tradycyjnych żarówek, ale wykorzystują najnowsze osiągnięcia technologii LED.

5 lat Gwarancji na warunkach oświadczenia gwarancyjnego, dostępnego na stronie internetowej

Materiał klosza: szkło

EXTREMELY efficient Kanlux XLED EX C35 3,8W light sources are equivalent to 60W incandescent bulbs. Their outstanding luminous efficacy (210 lumens per watt) makes these light sources 15 times more efficient than their traditional, standard antecedents. A 5-year warranty, 50,000 hours of durability and 50,000 ON/OFF cycles are additional advantages. What's more, the Kanlux XLED EX C35 has a glass bulb and filament 'rods' that make it similar to traditional incandescent bulbs but incorporates the latest advances in LED technology.

5 years Warranty under the terms of the warranty statement, available on our website
Lampshade material: glass

Kanlux XLEDDIM C35

ŹRÓDŁO ŚWIATŁA LED ► LED LIGHT SOURCE



XLEDDIM C35E14 5,9W-WW



XLEDDIM C35E14 5,9W-WW	35278	5905339352781	5,9	60	806	2700	320	E14	≥25000	D
------------------------	--------------	---------------	-----	----	-----	------	-----	-----	--------	---

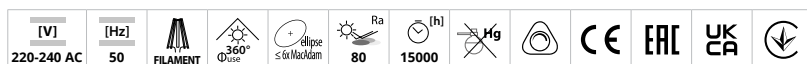

Kanlux XLED łączy w sobie najlepsze cechy tradycyjnych żarówek i nowoczesnych źródeł światła LED. Dlatego mówimy o nim, że to pierwsza prawdziwa „żarówka LED”. Szklana bańka jest w kształcie tradycyjnej „świeczki”, a diody LED rozmieszczone są w taki sposób, że światło rozchodzi się we wszystkich kierunkach, a kąt świecenia wynosi nawet 320 stopni! XLEDDIM C35 przystosowany jest do współpracy ze ściemniaczem.

Materiał klosza: szkło

Kanlux XLED combines the best features of traditional light bulbs and modern LED light sources. That is why we call it the first real “LED bulb”. The glass bulb is in the shape of a traditional “candle”, and the LEDs are arranged in such a way that the light spreads in all directions, and the beam angle is up to 320 degrees! XLED DIM C35 is adapted to work with a dimmer.

Lampshade material: glass

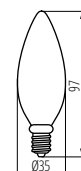

XLEDDIM C35E14 5,9W-WW

Kanlux XLED C35

ŹRÓDŁO ŚWIATŁA LED ► LED LIGHT SOURCE



XLED C35E14 2,5W

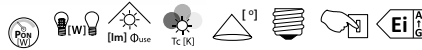

Model	Power [W]	Beam Angle [°]	Beam Diameter [mm]	Beam Length [mm]	Beam Diameter [mm]	Beam Length [mm]	Beam Diameter [mm]	Beam Length [mm]	Beam Diameter [mm]	Beam Length [mm]
XLED C35E14 2,5W-WW	29617	5905339296177	2,5	25	250	2700	320	E14	≥15000	F
XLED C35E14 4,5W-WW	29618	5905339296184	4,5	40	470	2700	320	E14	≥15000	F
XLED C35E14 4,5W-NW	29619	5905339296191	4,5	40	470	4000	320	E14	≥15000	F
XLED C35 E14 6W-WW	35272	5905339352729	6	60	806	2700	320	E14	≥25000	E
XLED C35 E14 6W-NW	35273	5905339352736	6	60	806	4000	320	E14	≥25000	E

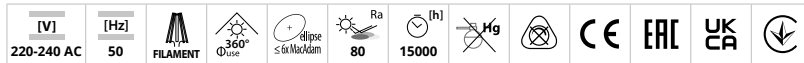

Kanlux XLED łączy w sobie najlepsze cechy tradycyjnych żarówek i nowoczesnych źródeł światła LED. Dlatego mówimy o nim, że to pierwsza prawdziwa „żarówka LED”. Szklana bańka jest w kształcie tradycyjnej „świeczki”, a diody LED rozmieszczone są w taki sposób, że światło rozchodzi się we wszystkich kierunkach, a kąt świecenia wynosi nawet 320 stopni!

Materiał klosza: szkło

Kanlux XLED combines the best features of traditional bulbs and modern LED light sources. Therefore, we talk about it as the first real LED bulb. A glass bulb in the shape of a traditional “candle” and LED diodes placed in such a way so that light can part in all directions, and the angle of light comes to even 320 degrees!

Lampshade material: glass

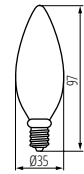

XLED C35 E14

Kanlux XLED C35M

ŹRÓDŁO ŚWIATŁA LED ► LED LIGHT SOURCE



XLED C35E14 4,5W, XLED C35E14 6W



XLED C35E27 6W



Model	Power [W]	Beam Angle [°]	Beam Diameter [mm]	Beam Length [mm]	Beam Diameter [mm]	Beam Length [mm]	Beam Diameter [mm]	Beam Length [mm]	Beam Diameter [mm]	Beam Length [mm]
XLED C35E14 4,5W-WW-M	29620	5905339296207	4,5	40	470	2700	320	E14	15000	F
XLED C35E14 4,5W-NW-M	29621	5905339296214	4,5	40	470	4000	320	E14	15000	F
XLED C35E14 6W-WW-M	29622	5905339296221	6	60	810	2700	320	E14	10000	D
XLED C35E14 6W-NW-M	29623	5905339296238	6	60	810	4000	320	E14	10000	D
XLED C35E27 6W-WW-M	29646	5905339296467	6	60	810	2700	320	E27	10000	D
XLED C35E27 6W-NW-M	29647	5905339296474	6	60	810	4000	320	E27	10000	D

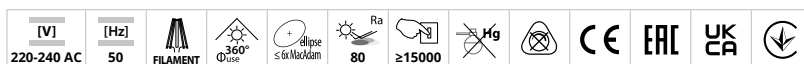

Kanlux XLED łączy w sobie najlepsze cechy tradycyjnych żarówek i nowoczesnych źródeł światła LED. Dlatego mówimy o nim, że to pierwsza prawdziwa „żarówka LED”. Matowa bańka jest w kształcie tradycyjnej „świeczki”, a diody LED rozmieszczone są w taki sposób, że światło rozchodzi się we wszystkich kierunkach i kąt świecenia wynosi nawet 320 stopni!

Materiał klosza: szkło

Kanlux XLED combines the best features of traditional bulbs and modern LED light sources. Therefore, we talk about it as the first real LED bulb. A mat bulb in the shape of a traditional “candle” and LED diodes placed in such a way so that light can part in all directions, and the angle of light comes to even 320 degrees!

Lampshade material: glass

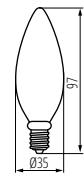

XLED C35E14 4,5W, XLED C35E14 6W

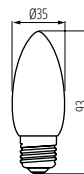

XLED C35E27 6W

Kanlux DUN LED

ŹRÓDŁO ŚWIATŁA LED ► LED LIGHT SOURCE

NEW



DUN 4,9W E14; DUN 6,5W E14

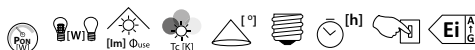

DUN 4,9W E14-WW	23434	5905339234346	4,9	40	470	3000	200	E14	15000	≥25000	F
DUN 4,9W E14-NW	23435	5905339234353	4,9	40	470	4000	200	E14	15000	≥25000	F
DUN 6,5W E14-NW	23436	5905339234360	6,5	60	806	4000	200	E14	20000	≥25000	E
DUN 6,5W E14-WW	23437	5905339234377	6,5	60	806	3000	200	E14	20000	≥25000	E

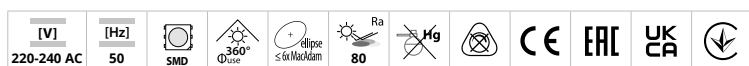

Niewielkich rozmiarów Kanlux DUN to żarówka typu „świeczka” o trzonku E14. Trwałość i energooszczędność tych źródeł została uzyskana dzięki zastosowaniu diod LED SMD. Kanlux DUN charakteryzują się dużą wydajnością świetlną. Doskonale nadają się do kinkietów i żyrandoli we wszystkich miejscach, gdzie pomimo niewielkiego źródła chcemy uzyskać dużo światła.

Material: tworzywo sztuczne

The small-size Kanlux DUN is a “candle-type” bulb with E14 screw. Durability of these light sources results from the combination of LED SMD diodes and ceramic housing. Kanlux DUN are characterised by high luminous efficiency. They are perfect for wall lamps and chandeliers in all places where we want to get a lot of light even though its source is small.

Material: plastic

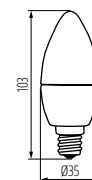

DUN 4,9W E14; DUN 6,5W E14

Kanlux IDO LED

ŹRÓDŁO ŚWIATŁA LED ► LED LIGHT SOURCE

NEW



IDO 6,5W E14



IDO 6,5W E14-NW	23438	5905339234384	6,5	60	806	4000	200	E14		E
IDO 6,5W E14-WW	23439	5905339234391	6,5	60	806	3000	200	E14		E



Niewielkich rozmiarów Kanlux IDO to żarówka typu „świeczka” o trzonku E14. Trwałość i energooszczędność tych źródeł została uzyskana dzięki zastosowaniu diod LED SMD. Kanlux IDO charakteryzują się dużą wydajnością świetlną. Doskonale nadają się do kinkietów i żyrandoli we wszystkich miejscach, gdzie pomimo niewielkiego źródła chcemy uzyskać dużo światła.

Material: tworzywo sztuczne

Material klosza: tworzywo sztuczne

The small-sized Kanlux IDO is a “candle” type bulb with an E14 cap. The durability and energy efficiency of these sources have been made possible through the use of SMD LEDs. Kanlux IDOs have a high luminous efficiency. They are perfect for wall lamps and chandeliers in all places where you want to get a lot of light even though its source is small.

Material: plastic

Lampshade material: plastic

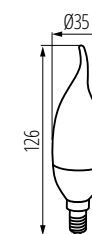

IDO 6,5W E14

IQ-LED G45

ŹRÓDŁO ŚWIATŁA LED ► LED LIGHT SOURCE



IQ-LED G45E14 3,4W



IQ-LED G45E27 3,4W



IQ-LED G45E14 5,9W



IQ-LED G45E27 5,9W



Kanlux IQ-LED G45 to przyjazna oczom temperatura barwowa i niezawodność, a to wszystko zachowane w klasycznym designie kulki. Nowe żarówki IQ-LED Kanlux to też wyjątkowa skuteczność świetlna, nawet do 138 lumenów z Wata, a za tym idzie mniejsze zużycie energii. IQ-LED Kanlux G45 dostępne są w wersji z trzonkiem E14 i E27, te źródła światła zapewniają pełen komfort użytkowania oraz bezpieczeństwo.

Materiał: tworzywo sztuczne

Materiał klosza: tworzywo sztuczne

Kanlux IQ-LED G45 is an eye-friendly color temperature and reliability, all preserved in classic ball design. New IQ-LED Kanlux bulbs it also has exceptional luminous efficiency, up to 138 lumens per Watt, and therefore lower energy consumption. IQ-LED Kanlux G45 is available in a version with a cup E14 and E27, these light sources provide complete comfort use and safety.

Materiał: plastic

Lampshade material: plastic



	[W]	[lm]	[K]	[°]	[E]	[A]	[D]		
IQ-LED G45E14 3,4W-WW	36688	5905339366887	3,4	40	470	2700	150	E14	D
IQ-LED G45E14 3,4W-NW	36689	5905339366894	3,4	40	470	4000	150	E14	D
IQ-LED G45E14 3,4W-CW	36690	5905339366900	3,4	40	470	6500	150	E14	D
IQ-LED G45E27 3,4W-WW	36691	5905339366917	3,4	40	470	2700	150	E27	D
IQ-LED G45E27 3,4W-NW	36692	5905339366924	3,4	40	470	4000	150	E27	D
IQ-LED G45E27 3,4W-CW	36693	5905339366931	3,4	40	470	6500	150	E27	D
IQ-LED G45E14 5,9W-WW	36694	5905339366948	5,9	60	806	2700	150	E14	D
IQ-LED G45E14 5,9W-NW	36695	5905339366955	5,9	60	806	4000	150	E14	D
IQ-LED G45E14 5,9W-CW	36696	5905339366962	5,9	60	806	6500	150	E14	D
IQ-LED G45E27 5,9W-WW	36697	5905339366979	5,9	60	806	2700	150	E27	D
IQ-LED G45E27 5,9W-NW	36698	5905339366986	5,9	60	806	4000	150	E27	D
IQ-LED G45E27 5,9W-CW	36699	5905339366993	5,9	60	806	6500	150	E27	D

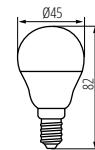

IQ-LED G45E14 3,4W

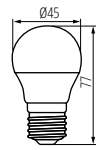

IQ-LED G45E27 3,4W

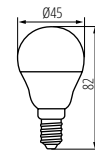

IQ-LED G45E14 5,9W

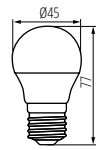

IQ-LED G45E27 5,9W



Kanlux

XLEDEX G45

ŹRÓDŁO ŚWIATŁA LED ► LED LIGHT SOURCE

NEW



XLEDEX G45E14 3,8W



XLEDEX G45E27 3,8W



EXTREMALNIE wydajne źródła światła Kanlux XLED EX G45 3,8W są odpowiednikiem żarówek 60W. Ponadprzeciętna skuteczność świetlna (210 lumenów z Wata) sprawia, że te źródła światła są 15 razy wydajniejsze od swoich tradycyjnych, standardowych poprzedników. 5 lat gwarancji, 50.000 godzin trwałości, 50.000 cykli włącz/wyłącz to ich kolejne zalety. Ponadto Kanlux XLED EX G45 posiadają szklaną bańkę i filamentowe „pręciki”, które upodabniają ją do tradycyjnych żarówek, ale wykorzystują najnowsze osiągnięcia technologii LED.

5 lat Gwarancji na warunkach oświadczenia gwarancyjnego, dostępnego na stronie internetowej

Materiał klosza: szkło

EXTREMELY efficient Kanlux XLED EX G45 3,8W light sources are equivalent to 60W incandescent bulbs. Their outstanding luminous efficacy (210 lumens per watt) makes these light sources 15 times more efficient than their traditional, standard antecedents. A 5-year warranty, 50,000 hours of durability and 50,000 ON/OFF cycles are additional advantages. What's more, the Kanlux XLED EX G45 has a glass bulb and filament 'rods' that make it similar to traditional incandescent bulbs but incorporates the latest advances in LED technology.

5 years Warranty under the terms of the warranty statement, available on our website

Lampshade material: glass



Model	Code	Part No.	Power (W)	Beam angle (°)	Lumen (lm)	Temp (K)	Base (mm)	Base Type	Class
XLEDEX G45E14 3,8W-WW	37342	5905339373427	3,8	60	806	2700	320	E14	A
XLEDEX G45E14 3,8W-NW	37343	5905339373434	3,8	60	806	4000	320	E14	A
XLEDEX G45E27 3,8W-WW	37344	5905339373441	3,8	60	806	2700	320	E27	A
XLEDEX G45E27 3,8W-NW	37345	5905339373458	3,8	60	806	4000	320	E27	A

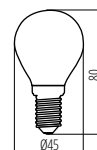

XLEDEX G45E14 3,8W

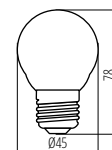

XLEDEX G45E27 3,8W

XLED G45

ŹRÓDŁO ŚWIATŁA LED ► LED LIGHT SOURCE



XLED G45 E14 4,5W



XLED G45 E27 4,5W



XLED G45 E14 6W



XLED G45 E27 6W

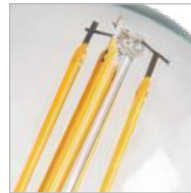

Kanlux XLED łączy w sobie najlepsze cechy tradycyjnych żarówek i nowoczesnych źródeł światła LED. Dlatego mówimy o nim, że to pierwsza prawdziwa „żarówka LED”. Szklana bańka w kształcie tradycyjnej „kulki” i diody LED rozmieszczone w taki sposób, że światło rozchodzi się we wszystkich kierunkach. Do wyboru mamy źródła z trzonkiem E27 i E14.

Materiał klosza: szkło

Kanlux XLED combines the best features of traditional bulbs and modern LED light sources. Therefore, we talk about it as the first real LED bulb. A glass bulb in the shape of a traditional "ball" and LED diodes placed in such a way so that light can part in all directions. You choose from sources with E27 and E14 light bulb bases.

Lampshade material: glass

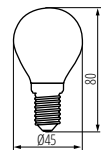

XLED G45 E14

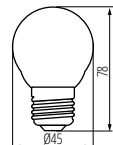

XLED G45 E27



	[W]	[lm]	[K]	[°]	[h]	[Ra]	[h]	[Ei]
XLED G45 E14 4,5W-WW	29624	5905339296245	4,5	40	470	2700	320	E14 ≥15000 F
XLED G45 E27 4,5W-WW	29625	5905339296252	4,5	40	470	2700	320	E27 ≥15000 F
XLED G45 E27 6W-WW	35274	5905339352743	6	60	806	2700	320	E27 ≥25000 E
XLED G45 E27 6W-NW	35275	5905339352750	6	60	806	4000	320	E27 ≥25000 E
XLED G45 E14 6W-WW	35276	5905339352767	6	60	806	2700	320	E14 ≥25000 E
XLED G45 E14 6W-NW	35277	5905339352774	6	60	806	4000	320	E14 ≥25000 E

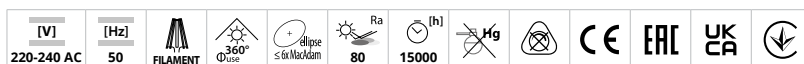

Kanlux

XLED G45M

ŹRÓDŁO ŚWIATŁA LED ► LED LIGHT SOURCE



XLED G45E14 4,5W, XLED G45E14 6W



XLED G45E14 4,5W, XLED G45E14 6W



XLED G45E27 4,5W, XLED G45E27 6W



Kanlux XLED łączy w sobie najlepsze cechy tradycyjnych żarówek i nowoczesnych źródeł światła LED. Dlatego mówimy o nim, że to pierwsza prawdziwa „żarówka LED”. Matowa bańka w kształcie tradycyjnej „kulki” i diody LED rozmieszczone w taki sposób, że światło rozchodzi się we wszystkich kierunkach. Do wyboru mamy źródła z trzonkiem E27 i E14.

Materiał klosza: szkło

Kanlux XLED combines the best features of traditional bulbs and modern LED light sources. Therefore, we talk about it as the first real LED bulb. A mat bulb in the shape of a traditional “ball” and LED diodes placed in such a way so that light can part in all directions. You choose from sources with E27 and E14 light bulb bases.

Lampshade material: glass



XLED G45E14 4,5W-WW-M	29626	5905339296269	4,5	40	470	2700	320	E14	15000	F		
XLED G45E14 4,5W-NW-M	29627	5905339296276	4,5	40	470	4000	320	E14	15000	F		
XLED G45 E14 6W-WW-M	29628	5905339296283	6	60	810	2700	320	E14	10000	D		
XLED G45 E14 6W-NW-M	29629	5905339296290	6	60	810	4000	320	E14	10000	D		
XLED G45E27 4,5W-WW-M	29630	5905339296306	4,5	40	470	2700	320	E27	15000	F		
XLED G45E27 4,5W-NW-M	29631	5905339296313	4,5	40	470	4000	320	E27	15000	F		
XLED G45 E27 6W-WW-M	29632	5905339296320	6	60	810	2700	320	E27	10000	D		
XLED G45 E27 6W-NW-M	29633	5905339296337	6	60	810	4000	320	E27	10000	D		

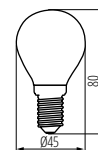

XLED G45E14 4,5W, XLED G45E14 6W

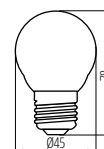

XLED G45E27 4,5W, XLED G45E27 6W

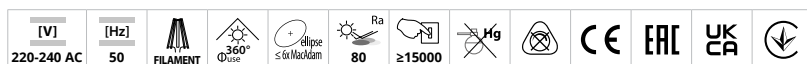

BILO LED

ŹRÓDŁO ŚWIATŁA LED ► LED LIGHT SOURCE



BILO 4,9W E27



BILO 4,9W E14



BILO 6,5W E27



BILO 6,5W E14



Kanlux BILO LED to trwałość i energooszczędność zamknięta w kształcie popularnej „kulki” o trzonku E14 i E27. Wszystkie modele Kanlux BILO LED charakteryzują się wysoką wydajnością świetlną (modele 6,5W do 124lm/W). To źródła, które doskonale nadają się do kinkietów i żyrandoli we wszystkich miejscach, gdzie znaczenie ma estetyka. Dodatkowo niski pobór mocy pomaga zadbać o oszczędność kosztów energii.

Materiał: tworzywo sztuczne

Materiał klosza: tworzywo sztuczne

Kanlux BILO means durability, which has been achieved thanks to LED SMD technology and a hybrid structure of the radiator. All Kanlux BILO 4.9W models are characterized by high light efficiency. These golf ball-shaped E14 and E27 bulbs are perfect for sconces and chandeliers in all places where aesthetics and an average amount of light with low power are important. In addition, low power consumption helps to save energy costs.

Materiał: plastic

Lampshade material: plastic

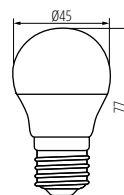

BILO E27

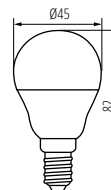

BILO E14



Model	Part No.	Power [W]	Light Output [lm]	Beam Angle [°]	Lifetime [h]	Base	Energy Class
BILO 4,9W E27-NW	23418	4,9	40	470	4000	E27	F
BILO 4,9W E27-WW	23419	4,9	40	470	3000	E27	F
BILO 4,9W E14-NW	23428	4,9	40	470	4000	E14	F
BILO 4,9W E14-WW	23429	4,9	40	470	3000	E14	F
BILO 6,5W E14-NW	26766	6,5	60	806	4000	E14	E
BILO 6,5W E14-WW	26767	6,5	60	806	3000	E14	E
BILO 6,5W E27-NW	26768	6,5	60	806	4000	E27	E
BILO 6,5W E27-WW	26769	6,5	60	806	3000	E27	E

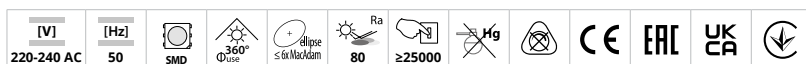

IQ-LEDEX GU10

ŹRÓDŁO ŚWIATŁA LED ► LED LIGHT SOURCE

NEW



IQ-LEDEX GU10 2,5W-NW



IQ-LEDEX GU10 2,5W-NW	33769	5905339337696	2,5	54	460	450	4000	100	GU10	A
-----------------------	--------------	---------------	-----	----	-----	-----	------	-----	------	---

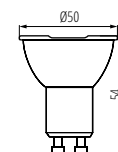
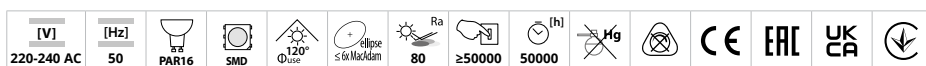

IQ-LEDEX GU10 2,5W-NW



Kanlux IQ-LED EX GU10 to nowe źródło światła o trzonku GU10 w znanej i popularnej serii produktów Kanlux IQ-LED. Charakteryzuje je ekstremalna skuteczność świetlna, pobiera tylko 2,5W energii, a daje tyle światła co tradycyjne 54W! 450 lumenów światła, klasa efektywności energetycznej A, 50.000 godzin świecenia - to najważniejsze atuty tego źródła. Oprócz tego Kanlux IQ-LED EX GU10 posiada wszystkie zalety serii IQ-LED.

5 lat Gwarancji na warunkach oświadczenia gwarancyjnego, dostępnego na stronie internetowej

Materiał klosza: tworzywo sztuczne

Kanlux IQ-LED EX GU10 is a new light source with a GU10 base in the well-known and popular series of Kanlux IQ-LED products. They are characterized by extreme luminous efficiency, consume only 2.5W of energy, and give as much light as traditional 54W! 450 lumens of light, energy efficiency class A, 50,000 hours of lighting - these are the most important advantages of this source. In addition, Kanlux IQ-LED EX GU10 has all the advantages of the IQ-LED series.

5 years Warranty under the terms of the warranty statement, available on our website
Lampshade material: plastic

IQ-LED GU10 4,9W

ŹRÓDŁO ŚWIATŁA LED ► LED LIGHT SOURCE

NEW



IQ-LED GU10 4,9W



IQ-LED GU10 4,9W-WW	35256	5905339352569	4,9	44	550	2700	120	GU10	E
IQ-LED GU10 4,9W-NW	35257	5905339352576	4,9	44	550	4000	120	GU10	E
IQ-LED GU10 4,9W-CW	35258	5905339352583	4,9	44	550	6500	120	GU10	E

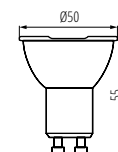
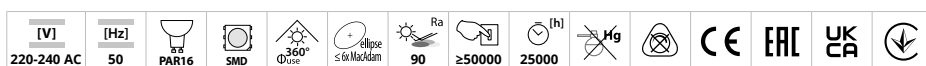

IQ-LED GU10 4,9W

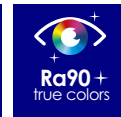

Kanlux IQ-LED GU10 to przyjazna oczom temperatura barwowa i niezawodność, a to wszystko zachowane w znanym kształcie żarówek halogenowych. Nowe żarówki IQ-LED GU10 Kanlux to też wyjątkowa skuteczność świetlna, powyżej 100 lumenów z Wata, a za tym idzie mniejsze zużycie energii. IQ-LED GU10 zapewniają pełen komfort użytkowania dzięki dokładnemu odwzorowaniu kolorów (Ra 90).

Materiał: szkło

Materiał klosza: tworzywo sztuczne

Kanlux IQ-LED GU10 provides an eye-friendly temperature of colour and reliability, and all this in the classic shape of halogen bulbs. The new IQ-LED GU10 bulbs by Kanlux also offer exceptional luminous efficacy, more than 100 Lumens per Watt, and as a result lower energy consumption. IQ-LED GU10s provide full user comfort with their accurate colour reproduction (Ra 90).

Materiał: glass

Lampshade material: plastic

Kanlux

IQ-LED GU10

ŹRÓDŁO ŚWIATŁA LED ► LED LIGHT SOURCE



IQ-LED GU10 6,5W



IQ-LED GU10 6,5WS3



Kanlux IQ-LED to bezpieczeństwo fotobiologiczne, przyjazna oczom temperatura barwowa i niezawodność. Teraz to wszystko w nowej wersji z trzonkiem GU10. Żarówki IQ-LED zapewniają pełen komfort użytkowania oraz bezpieczeństwo.

Material klosza: tworzywo sztuczne



Kanlux IQ-LED means photo-biological safety, colour temperature friendly to eyes and reliability. Now, all this in a new version with GU10 light bulb base. IQ-LED bulbs ensure full comfort of use and safety.

Lampshade material: plastic



			[W]	[lm]	[lm] Øuse	Tc [K]	[°]			
IQ-LED GU10 6,5W-WW	35240	5905339352408	6,5	59	580	510	2700	110	GU10	F
IQ-LED GU10 6,5W-NW	35241	5905339352415	6,5	60	585	515	4000	110	GU10	F
IQ-LED GU10 6,5W-CW	35242	5905339352422	6,5	60	585	515	6500	110	GU10	F
IQ-LED GU10 6,5WS3-WW	35243	5905339352439	6,5	85	580	535	2700	36	GU10	F
IQ-LED GU10 6,5WS3-NW	35244	5905339352446	6,5	86	580	540	4000	36	GU10	F
IQ-LED GU10 6,5WS3-CW	35245	5905339352453	6,5	86	580	540	6500	36	GU10	F

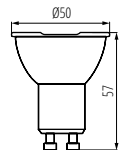

IQ-LED GU10 6,5W

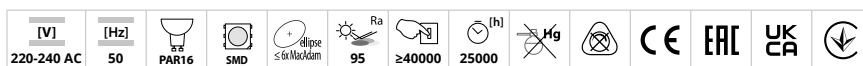

Kanlux

IQ-LEDIM GU10

ŹRÓDŁO ŚWIATŁA LED ► LED LIGHT SOURCE



IQ-LEDDIM GU10 7W



DIMMING
function

Ra95+
true colors

SAFE
light

3+
WARRANTY
3 years

Kanlux IQ-LED to bezpieczeństwo fotobiologiczne, przyjazna oczom temperatura barwowa i niezawodność. Teraz to wszystko w nowej wersji z trzonkiem GU10 - dodatkowo wersja IQ-LEDIM współpracuje ze ściemniaczami. Żarówki IQ-LED zapewniają pełen komfort użytkowania oraz bezpieczeństwo.

Materiał klosza: tworzywo sztuczne

Kanlux IQ-LEDs ensure photobiological safety, have a colour temperature that is beneficial to the eyes and are reliable. A new version with GU10 cap is now available - additionally the IQ-LEDIM version is compatible with dimmers. IQ-LED bulbs provide full comfort and safety.

Lampshade material: plastic

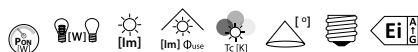

IQ-LEDDIM GU10 7W-WW	35246	5905339352460	7	59	570	490	2700	110	GU10	G
IQ-LEDDIM GU10 7W-NW	35247	5905339352477	7	60	575	495	4000	110	GU10	G
IQ-LEDDIM GU10 7W-CW	35248	5905339352484	7	60	575	495	6500	110	GU10	G

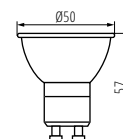

IQ-LEDDIM GU10 7W

[V] 220-240 AC

[Hz] 50

PAR16

SMD

120° Φ_{use}

ellipse ≤60 MacAdam

Ra 95

≥40000

25000

[h]

Hg

RoHS

CE

EAC

UK

Recycle

Kanlux

K LED GU10 6W

ŹRÓDŁO ŚWIATŁA LED ► LED LIGHT SOURCE

NEW



K LED GU10 6W

HIGH
lumen

MILKY
cover

Kanlux K LED GU10 to dwa typy ekonomicznych źródeł światła LED. Strumień świetlny dochodzący do 600 lumenów sprawia, że możemy je zastosować w każdym pomieszczeniu jak światło uzupełniające lub zestawiając kilka źródeł jak główne, mocno światło. Dzięki dwóm barwom do wyboru (neutralna i zimna) z powodzeniem dopasujemy je do naszych preferencji.

Materiał: tworzywo sztuczne

Materiał klosza: tworzywo sztuczne

Kanlux K LED GU10 are two types of economical LED light sources. The luminous flux of up to 600 lumens makes it possible to use them in any room as supplementary light or by combining several sources as the main, strong light. Thanks to two colors to choose from (neutral and cold), we can successfully match them to our preferences.

Materiał: plastic

Lampshade material: plastic

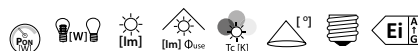

K LED GU10 6W-NW	36331	5905339363312	6	50	560	500	4000	100	GU10	F
K LED GU10 6W-CW	36332	5905339363329	6	50	560	500	6500	100	GU10	F
K LED N GU10 6W-WW	36333	5905339363336	6	50	560	485	3000	100	GU10	F

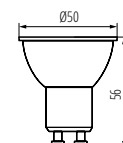

K LED GU10 6W

[V] 220-240 AC

[Hz] 50

PAR16

SMD

6

120° Φ_{use}

ellipse ≤60 MacAdam

Ra 80

≥15000

20000

[h]

Hg

RoHS

CE

EAC

UK

Recycle

TOMiv2 LED

ŹRÓDŁO ŚWIATŁA LED ► LED LIGHT SOURCE



Kanlux TOMI v2 to nowa, jeszcze bardziej wydajna konstrukcja zapewniająca wysokie parametry świetlne. Dzięki zastosowaniu matowej przesłony światło w tych źródłach jest rozprowadzane równomiernie. Ponadto źródła te charakteryzują się wysoką skutecznością świetlną.

Materiał: tworzywo sztuczne

Materiał klosza: tworzywo sztuczne

Kanlux TOMI v2 is a new and even more efficient design ensuring high lighting parameters. Thanks to the application of a matt cover, the light in these lamps is distributed evenly. Moreover, these lamps are characterised by high luminous efficiency.

Materiał: plastik

Lampshade material: plastic

TOMiv2 1,2W GU10



TOMiv2 2,9W GU10



TOMiv2 4,9W GU10



TOMiv2 6,5W GU10

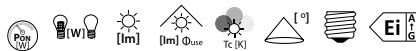

Model	Code	Part No.	Power [W]	Beam Angle [°]	Height [mm]	Width [mm]	Temp. [K]	Light Output [lm]	Beam Spread [mm]	Base	Class
TOMiv2 1,2W GU10-CW	34960	5905339349606	1,2	15	120	105	6500	100	GU10	F	
TOMiv2 1,2W GU10-NW	34961	5905339349613	1,2	15	120	105	4000	100	GU10	F	
TOMiv2 1,2W GU10-WW	34962	5905339349620	1,2	15	120	105	3000	100	GU10	F	
TOMiv2 2,9W GU10-CW	34963	5905339349637	2,9	28	295	240	6500	100	GU10	F	
TOMiv2 2,9W GU10-NW	34964	5905339349644	2,9	28	295	240	4000	100	GU10	F	
TOMiv2 2,9W GU10-WW	34965	5905339349651	2,9	28	295	240	3000	100	GU10	F	
TOMiv2 4,9W GU10-CW	34966	5905339349668	4,9	42	490	400	6500	100	GU10	F	
TOMiv2 4,9W GU10-NW	34967	5905339349675	4,9	42	490	400	4000	100	GU10	F	
TOMiv2 4,9W GU10-WW	34968	5905339349682	4,9	42	490	400	3000	100	GU10	F	
TOMiv2 6,5W GU10-CW	34969	5905339349699	6,5	61	650	530	6500	100	GU10	F	
TOMiv2 6,5W GU10-NW	34970	5905339349705	6,5	61	650	530	4000	100	GU10	F	
TOMiv2 6,5W GU10-WW	34971	5905339349712	6,5	61	650	530	3000	100	GU10	F	

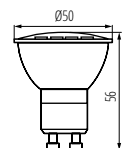

TOMiv2 GU10

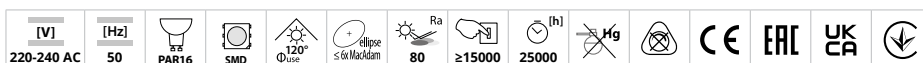

Kanlux REMI LED

ŹRÓDŁO ŚWIATŁA LED ► LED LIGHT SOURCE



REMI LED GU10



LEDowe źródła światła Kanlux REMI LED przeznaczone są do opraw oświetleniowych o niewielkich rozmiarach. Ich kąt świecenia to 100°. Żarówka ta wyróżnia się małym kształtem, dlatego świetnie sprawdzi się w zgrabnych, małych lampach.

Materiał: tworzywo sztuczne

LED light sources Kanlux REMI LED are designed for small-size luminaires. Their illumination angle is 100°. The bulb is distinguished by its small size so it will be useful for neat, small lamps.

Materiał: plastic



Model	Code	Power [W]	Beam angle [°]	Luminous flux [lm]	Temp. [K]	Beam spread [°]	Base	Beam type
REMI LED GU10-NW	33080	5905339330802	2,2	200	180	4000	GU10	F
REMI LED GU10-WW	33081	5905339330819	2,2	180	165	3000	GU10	F
REMI LED GU10-CW	33082	5905339330826	2,2	200	180	6500	GU10	F

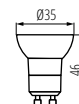

REMI LED GU10

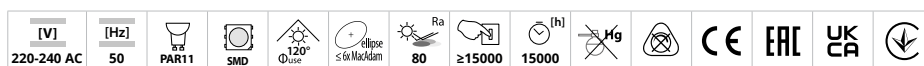

Kanlux TEDI MAXX LED

ŹRÓDŁO ŚWIATŁA LED ► LED LIGHT SOURCE



TEDI MAXX LED GU10



Kanlux TEDI MAXX LED to moc zamknięta w niewielkim korpusie. Wydajne diody LED oraz ceramiczna obudowa to tylko niektóre atuty tych źródeł. Stabilizowany zasilacz zapewnia zminimalizowanie efektu migotania, który mógłby męczyć wzrok. Ponadto Kanlux TEDI MAXX to wydajność świetlna 100lm z Wata, a zastosowana matowa szybka zapewnia równomierny rozsył światła.

Materiał: ceramika

Materiał klosza: tworzywo sztuczne

The Kanlux TEDI MAXX is power enclosed in a small body. Efficient LED's and ceramic casing are just two of the advantages of this light source. The stabilised power supply minimises the flicker effect, which could cause eye fatigue. In addition, The Kanlux TEDI MAXX has a light output of 100lm per 1 Watt, and the matte glass used ensures uniform light distribution.

Materiał: ceramics

Lampshade material: plastic



Model	Code	Power [W]	Beam angle [°]	Luminous flux [lm]	Temp. [K]	Beam spread [°]	Base	Beam type
TEDI MAXX LED GU10-WW	23412	5905339234124	9	65	900	3000	GU10	F
TEDI MAXX LED GU10-CW	23413	5905339234131	9	65	900	6000	GU10	F
TEDI MAXX LED GU10-NW	23414	5905339234148	9	65	900	4000	GU10	F

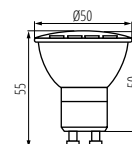

TEDI MAXX LED GU10

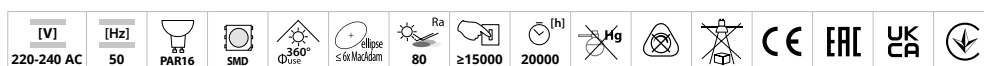

Kanlux ZUBI LED

ŹRÓDŁO ŚWIATŁA LED ► LED LIGHT SOURCE

NEW



ZUBI LED 4W G9



ZUBI LED 4W E14



Kanlux ZUBI LED to energooszczędne źródła światła LED. Wysoki strumień świetlny i niewielkie rozmiary pozwalają użyć tego źródła w bardzo wielu oprawkach. Konstrukcja źródeł Kanlux ZUBI gwarantuje szeroki kąt świecenia, dzięki temu idealnie nadaje się do zastosowania również we wszelkich otwartych oprawkach i żyrandolach.

Materiał: tworzywo sztuczne

Kanlux ZUBI LED are energy-saving LED light sources. High luminous flux of 520lm and small size allow this source to be used in many luminaires. The construction of Kanlux ZUBI sources guarantees a wide lighting angle, thanks to which it is ideal for use in all open luminaires and chandeliers.

Materiał: plastic



ZUBI LED 4W G9-CW	24519	5905339245199	4	42	520	6500	320	G9	≥15000	E
ZUBI LED 4W G9-VVV	24526	5905339245267	4	42	520	3000	320	G9	≥15000	E
ZUBI LED 4W G9-NW	24527	5905339245274	4	42	520	4000	320	G9	≥15000	E
ZUBI LED 4W E14-VVV	24528	5905339245281	4	42	520	3000	320	E14	≥15000	E
ZUBI LED 4W E14-NW	24529	5905339245298	4	42	520	4000	320	E14	≥15000	E

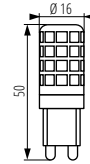
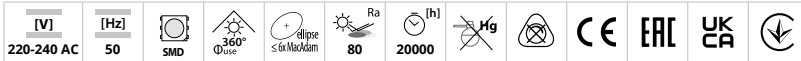

ZUBI LED 4W G9

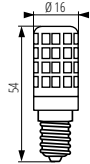

ZUBI LED 4W E14



Kanlux TANO G4

ŹRÓDŁO ŚWIATŁA LED ► LED LIGHT SOURCE



TANO G4 SMD



Kanlux TANO to kapsułka LED z trzonkiem typu G4 oparta na wydajnych diodach LED. Kąt świecenia tego źródła to 300°, jego trwałość wynosi 20.000 godzin. Źródła Kanlux TANO G4 zasilane są napięciem 12V.

Materiał: tworzywo sztuczne

Kanlux TANO is an LED capsule with a G4 base based on efficient LED diodes. The lighting angle of this source is 300°, its durability is 20,000 hours. Kanlux TANO G4 sources are powered by 12V.

Materiał: plastic



TANO G4 SMD-WW	14936	5907540962483	1,5	11	100	3000	300	G4	G
TANO G4 SMD-NW	14937	5905339149374	1,5	11	105	4000	300	G4	G

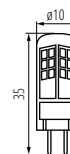

TANO G4 SMD

Kanlux LED12 G4

ŹRÓDŁO ŚWIATŁA LED ► LED LIGHT SOURCE



LED12 G4

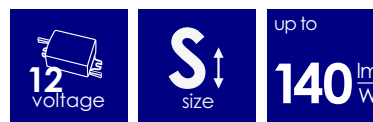

Kanlux LED12 G4 to kapsułka LED oparta na nowych, bardzo wydajnych diodach LED. Kąt świecenia źródła to 120°, jego trwałość wynosi 20.000 godzin, a wydajność dla wersji NW to aż 140 lumenów z wata.

Kanlux LED12 G4 is an LED capsule based on new, high-performance LEDs. The source's lighting angle is 120°, its life is 20,000 hours, and the efficiency for NW colour is as much as 140 lm/W.

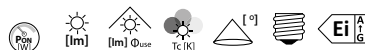

LED12 G4-WW	18502	5905339185020	1,2	165	135	3000	120	G4	E
LED12 G4-NW	18503	5905339185037	1,2	170	140	4000	120	G4	E

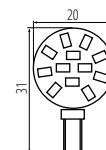
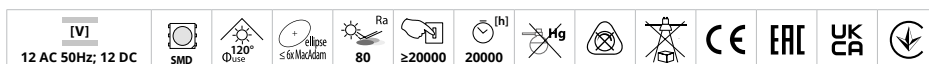

LED12 G4

Kanlux

IQ-LED EX T8

ŹRÓDŁO ŚWIATŁA LED ► LED LIGHT SOURCE

NEW



IQ-LED EX T8 12W



5
WARRANTY
5 years

up to
210 lm
W

PF >0.9
high

GLASS
tube

Kanlux IQ-LED EX T8 to nowe źródło światła znanej linii premium wersji T8. Oparte są na wysokowydajnych diodach LED umieszczonych w mlecznym, szklanym korpusie równomiernie emitują światło. Wysoka jakość wykonania i dbałość o najlepszej klasy komponenty lamp IQ-LED EX T8 to: 5 lat gwarancji, 50.000 godzin trwałości i ekstremalna skuteczność świetlna aż 210 lumenów z Wata.

5 lat gwarancji na warunkach oświadczenia gwarancyjnego, dostępnego na stronie internetowej

Materiał klosza: szkło

Kanlux IQ-LED EX T8 is a new light source of the well-known premium line of the T8 version. They use highly efficient LEDs housed in a milky glass luminaire to emit light evenly. The high-quality workmanship and attention to top-class components of the IQ-LED EX T8 lamps result in: a 5-year warranty, 50,000 hours of service life and an extreme luminous efficacy of up to 210 Lumens per Watt.

5 years Warranty under the terms of the warranty statement, available on our website
Lampshade material: glass

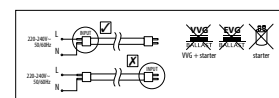

OR

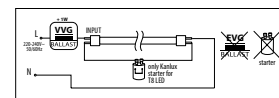

IQ-LED EX T8 12W-NW	35254	5905339352545	12	2520	4000	200	G13	A
IQ-LED EX T8 12W-CW	35255	5905339352552	12	2520	6500	200	G13	A

[V]
220-240 AC

[Hz]
50

T8 LED

SMD

360°
Φuse

ellipse
≤ 6° Max/Adam

Ra
80

≥50000

50000

Hg

ONE SIDE INPUT

CE

EAC

UK CA

⌚

AKCESORIA ► ACCESSORIES

T8 LED STARTER | **26069** | 5905339260697 Zapłonnik zamienny LED (26069) | Replacement LED light switch (26069)

IQ-LED EX T8 12W

Kanlux

T8 LED GLASSv3

ŹRÓDŁO ŚWIATŁA LED ▶ LED LIGHT SOURCE



up to

140 $\frac{\text{lm}}{\text{W}}$



Kanlux T8 LED GLASS to znana i sprawdzona linia świetlówek oparta na wysokowydajnych diodach LED SMD, które umieszczone są w mlecznym, szklanym korpusie. Wysoka jakość wykonania i dbałość o najlepszej klasy komponenty to najważniejsze cechy T8 LED GLASSv3.

Materiał klosza: szkło

The Kanlux T8 LED GLASS is a well-known and proven line of fluorescent lamps utilising high-performance SMD LED's in a milky-coloured glass body. The high quality of workmanship and the care taken over choosing the best-quality components are the most-important features of the T8 LED GLASSv3.

Lampshade material: glass



T8 LED GLASSv3

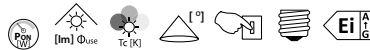

T8 LED GLASSv3 9W-NW	26062	5905339260628	9	1260	4000	250	≥15000	G13	D
T8 LED GLASSv3 9W-CW	26063	5905339260635	9	1260	6500	250	≥15000	G13	D
T8 LED GLASSv3 18W-NW	26064	5905339260642	18	2520	4000	250	≥15000	G13	D
T8 LED GLASSv3 18W-CW	26065	5905339260659	18	2520	6500	250	≥15000	G13	D
T8 LED GLASSv3 22W-NW	26058	5905339260581	22	3080	4000	250	≥25000	G13	D
T8 LED GLASSv3 22W-CW	26059	5905339260598	22	3080	6500	250	≥25000	G13	D

[V] 220-240 AC	[Hz] 50	T8 LED	SMD	360° Φuse	≤6 MacAdam	Ra 80	[h] 25000	Hg
		L N ONE SIDE INPUT	-10+40	CE	ERC	UK CA		

AKCESORIA ▶ ACCESSORIES

T8 LED STARTER | **26069** | 5905339260697 | Zapłonnik zamienny LED (26069) | Replacement LED light switch (26069)

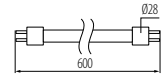

T8 LED GLASSv3 9W

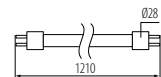

T8 LED GLASSv3 18W

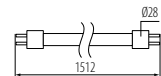

T8 LED GLASSv3 22W

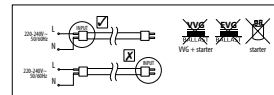

OR

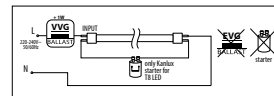

Kanlux

T8 LED GLASSv3T

ŹRÓDŁO ŚWIATŁA LED ▶ LED LIGHT SOURCE



up to

145 $\frac{\text{lm}}{\text{W}}$



Kanlux T8 LED GLASS to znana i sprawdzona linia świetlówek oparta na wysokowydajnych diodach LED SMD. Kanlux T8 LED GLASSv3T znajduje się w transparentnym, szklanym korpusie. Nowe modele charakteryzują się wyższą skutecznością świetlną i węższym kątem emisji światła wynoszącym 120°.

Jednostronne zasilanie świetlówek LED

Materiał klosza: szkło

The Kanlux T8 LED GLASS is a well-known and proven line of fluorescent lamps utilising high-performance SMD LED's. The Kanlux T8 LED GLASSv3T is fitted in a transparent glass body. The new models have a higher luminous efficacy and the narrower light-emission angle of 120°.

One-way fluorescent LED-power supply

Lampshade material: glass



T8 LED GLASSv3T



T8 LED GLASSv3T 18W NW	26068	5905339260680	18	2610	4000	120	G13	D
------------------------	--------------	---------------	----	------	------	-----	-----	---

[V] 220-240 AC	[Hz] 50	T8 LED	SMD	360° Φuse	≤6 MacAdam	Ra 80	[h] ≥15000	25000
		L N ONE SIDE INPUT	-10+40	CE	ERC	UK CA		

AKCESORIA ▶ ACCESSORIES

T8 LED STARTER | **26069** | 5905339260697 | Zapłonnik zamienny LED (26069) | Replacement LED light switch (26069)

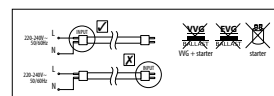

OR

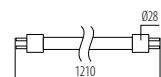
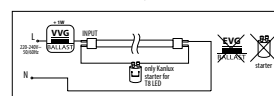

T8 LED GLASSv3T

Kanlux

T8 LED GLASSv4

ŹRÓDŁO ŚWIATŁA LED ► LED LIGHT SOURCE



3+
WARRANTY
3 years

up to
160 lm/W

PF >0,9
high

GLASS
tube

Kanlux T8 LED GLASS to znana i sprawdzona linia świetlówek oparta na wysokowydajnych diodach LED, które umieszczone są w mlecznym, szklanym korpusie, przez co równomiernie emitują światło. Wysoka jakość wykonania i dbałość o najlepszej klasy komponenty to najważniejsze cechy T8 LED GLASSv4. Ponadto te wyjątkowe świetlówki LEDowe to 3 lata gwarancji i skuteczność świetlna aż do 160 lumenów z Wata.

Jednostronne zasilanie świetlówek LED

3 lata gwarancji na warunkach oświadczenia gwarancyjnego, dostępnego na stronie internetowej

Materiał klosza: szkło

Kanlux T8 LED GLASS is a well-known and proven line of fluorescent lamps based on high-performance LED diodes, which are placed in a milky, glass body, thanks to which they evenly emit light. High-quality workmanship and care for the best-class components are the most important features of Kanlux T8 LED GLASSv4. In addition, these unique LED lamps have a 3-year warranty and a luminous efficacy of up to 160 lumens from Watt.

One-way fluorescent LED-power supply

3 years Warranty under the terms of the warranty statement, available on our website

Lampshade material: glass



T8 LED GLASSv4



T8 LED GLASSv4 9W-NW	33210	5905339332103	9	1440	4000	220	G13	C
T8 LED GLASSv4 9W-CW	33211	5905339332110	9	1440	6500	220	G13	C
T8 LED GLASSv4 18W-NW	33212	5905339332127	18	2880	4000	220	G13	C
T8 LED GLASSv4 18W-CW	33213	5905339332134	18	2880	6500	220	G13	C
T8 LED GLASSv4 24W-NW	33214	5905339332141	24	3840	4000	220	G13	C
T8 LED GLASSv4 24W-CW	33215	5905339332158	24	3840	6500	220	G13	C

[V] 220-240 AC	[Hz] 50	T8 LED	SMD	360° Φ _{use}	ellipse ≤ 6° MacAdam
Ra 80	≥30000	30000 [h]	Hg		
L N ONE SIDE INPUT	-10+40 [°C]	CE	ERC	UK CA	

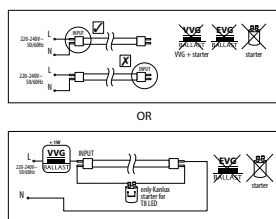

AKCESORIA ► ACCESSORIES

T8 LED STARTER | **26069** | 5905339260697 | Zapłonnik zamienny LED (26069) | Replacement LED light switch (26069)

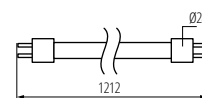

T8 LED GLASSv4 18W

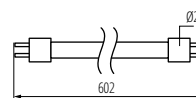

T8 LED GLASSv4 9W

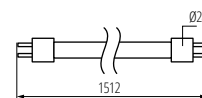

T8 LED GLASSv4 24W

Kanlux

T8 LED GLASSv5

ŹRÓDŁO ŚWIATŁA LED ► LED LIGHT SOURCE



T8 LED GLASSv5

4+
WARRANTY
4 years

up to
185 lm/W

PF >0,9
high

GLASS
tube

Kanlux T8 LED GLASSv5 to kolejna wersja znanej linii świetlówek. Oparte są na wysokowydajnych diodach LED, które umieszczone w mlecznym, szklanym korpusie równomiernie emitują światło. Wysoka jakość wykonania i dbałość o najlepszej klasy komponenty lamp T8 LED GLASSv5 to 4 lata gwarancji i skuteczność świetlna aż 185 lumenów z Wata.

4 lata gwarancji na warunkach oświadczenia gwarancyjnego, dostępnego na stronie internetowej

Materiał klosza: szkło

Kanlux T8 LED GLASS v5 is another version of the well-known line of LED tubes. They are based on high-efficiency LEDs, which are placed in a milky glass body and emit light evenly. High quality finish and care for the best-class components of T8 LED GLASSv5 tubes that's 4-Year warranty and luminous efficiency of up to 185 lumens per Watt.

4 years Warranty under the terms of the warranty statement, available on our website

Lampshade material: glass



T8 LED GLASSv5 12W-NW	33216	5905339332165	12	2220	4000	200	G13	B
T8 LED GLASSv5 12W-CW	33217	5905339332172	12	2220	6500	200	G13	B

[V] 220-240 AC	[Hz] 50	T8 LED	SMD	360° Φ _{use}	ellipse ≤ 6° MacAdam	Ra 80	≥50000	40000 [h]
Hg			L N ONE SIDE INPUT	-10+40 [°C]	CE	ERC	UK CA	

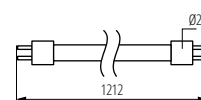
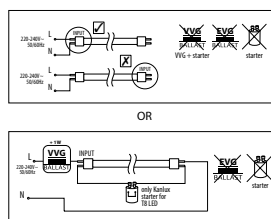

T8 LED GLASSv5 12W

AKCESORIA ► ACCESSORIES

T8 LED STARTER | **26069** | 5905339260697 | Zapłonnik zamienny LED (26069) | Replacement LED light switch (26069)

Kanlux

TOMI LED

ŹRÓDŁO ŚWIATŁA LED ► LED LIGHT SOURCE



TOMI LED 5W MR16; 7W MR16

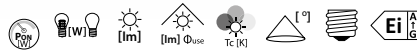

TOMI LED 5W MR16-WW	22704	5905339227041	5	26	370	300	3000	120	Gx5,3	G
TOMI LED 5W MR16-CW	22705	5905339227058	5	27	390	310	5300	120	Gx5,3	G
TOMI LED 7W MR16-WW	22706	5905339227065	7	35	570	470	3000	120	Gx5,3	G
TOMI LED 7W MR16-CW	22707	5905339227072	7	35	580	480	5300	120	Gx5,3	G

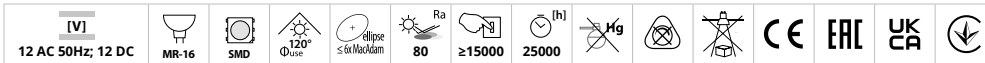

Kanlux TOMI LED to trwałe źródło LED typu MR16 o klasycznym wyglądzie. W źródłach Kanlux TOMI LED zastosowano hybrydową konstrukcję radiatora (warstwa termotworzywa + aluminiowy wkład), dzięki czemu wymiana ciepła z otoczeniem jest dużo efektywniejsza, a trwałość źródła wynosi 25.000h. Matowa szybka równomiernie rozprasza światło, którego kąt padania wynosi 120°.

Materiał klosza: tworzywo sztuczne

Kanlux TOMI LED are MR16 type solid LED sources of classic look. Kanlux TOMI LED sources use hybrid heat sink construction thanks to which heat exchange with the environment is much more effective. The matt glass evenly diffuses the light with its illumination angle amounting to 120°.

Lampshade material: plastic

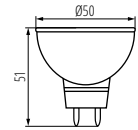

TOMI LED 5W MR16

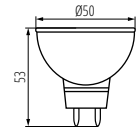

TOMI LED 7W MR16

Kanlux

SIGO LED

ŹRÓDŁO ŚWIATŁA LED ► LED LIGHT SOURCE



SIGO R39 LED E14

SIGO R50 LED E14

SIGO R63 LED E27

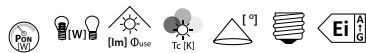

SIGO R39 LED E14-WW	22733	5905339227331	4	29	320	3000	120	E14	G
SIGO R39 LED E14-NW	22734	5905339227348	4	29	320	4000	120	E14	G
SIGO R50 LED E14-WW	22735	5905339227355	6	41	490	3000	120	E14	G
SIGO R50 LED E14-NW	22736	5905339227362	6	41	490	4000	120	E14	G
SIGO R63 LED E27-WW	22737	5905339227379	8	54	720	3000	120	E27	F
SIGO R63 LED E27-NW	22738	5905339227386	8	54	720	4000	120	E27	F

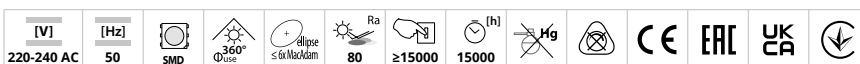

Kanlux SIGO LED to nie tylko oszczędność energii, ale też trwałość 25-krotnie wyższa niż w tradycyjnych żarówkach reflektorowych. Ponieważ ich kształt i rozmiar przypominają standardowe żarówki reflektorowe, łatwo je wymienić bez konieczności dodatkowych modyfikacji.

Materiał klosza: tworzywo sztuczne

Kanlux SIGO LED is both energy-efficient and 25 times more durable than traditional reflector bulbs. Since their shape and size resembles standard reflector bulbs, they are easily replaceable without additional modifications.

Lampshade material: plastic

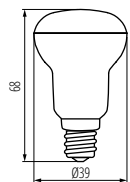

SIGO R39 LED E14

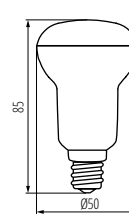

SIGO R50 LED E14

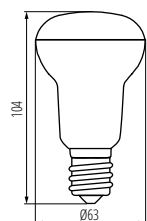

SIGO R63 LED E27

Kanlux ESG LED

ŹRÓDŁO ŚWIATŁA LED ► LED LIGHT SOURCE



Kanlux ESG LED charakteryzuje się estetycznym wykonaniem i trwałą konstrukcją. Matowy klosz gwarantuje równomierny i szeroki rozsył światła. Biała obudowa wykonana z aluminium zapewnia prawidłowe odprowadzenie ciepła, a wysokowydajne diody LED SMD trwałość 20.000h.

Materiał: stop aluminium, tworzywo sztuczne

Kanlux ESG LED is characterised by aesthetic design and durable construction. The matte shade guarantees an even and wide light distribution. White housing made of aluminium ensures proper heat dissipation and high performance SMD LEDs ensure durability for 20.000 h.

Material: aluminum alloy, plastic

ESG LED 9W GX53

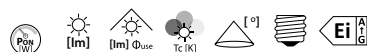

ESG LED 9W GX53-VVV	22422	5905339224224	9	720	595	3000	110	GX53	G
ESG LED 9W GX53-NVV	22423	5905339224231	9	750	600	4000	110	GX53	G
ESG LED 9W GX53-CVV	22424	5905339224248	9	750	600	6000	110	GX53	G

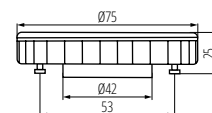

ESG LED 9W GX53

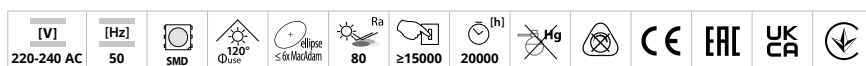

Kanlux RANGO LED

ŹRÓDŁO ŚWIATŁA LED ► LED LIGHT SOURCE



RANGO R7S SMD



RANGO MINI R7S SMD-WW



Ledowe źródło Kanlux RANGO to idealne rozwiązanie energooszczędne dla wszelkiego rodzaju lamp i naświetlaczy o trzonku R7s.

Materiał: tworzywo sztuczne

Materiał klosza: szkło

LED source Kanlux RANGO is the perfect energy-saving solution for all types of lamps and floodlights with R7s screw.

Materiał: plastic

Lampshade material: glass

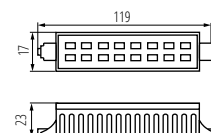

RANGO R7S SMD

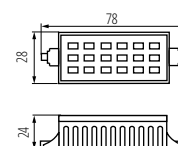

RANGO MINI R7S SMD

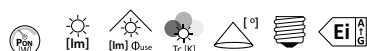

RANGO R7S SMD-WW	15098	5907540962155	6	640	550	3000	110	R7s	F
RANGO MINI R7S SMD-WW	15099	5907540962568	6	600	510	3000	110	R7s	F



Kanlux

MODv2 LED

ŹRÓDŁO ŚWIATŁA LED ► LED LIGHT SOURCE



Kanlux MOD LED to profesjonalna seria modułów LED przeznaczona do modyfikacji lamp, w których mieliśmy starego typu żarówki. Moduł charakteryzuje się łatwością montażu. Kanlux MOD LED to wysokiej jakości diody LED SMD, które wyróżniają się energooszczędnością i długim czasem działania.

Materiał klosza: tworzywo sztuczne

Kanlux MOD LED is a professional series of LED modules designed for modification of lamps which used the old type of light bulbs. The module can be installed easily. Kanlux MOD LED are high-quality SMD LEDs, distinguished by energy efficiency and long lifetime.

Lampshade material: plastic

MODv2 LED 12W



MODv2 LED 12W



MODv2 LED 19W

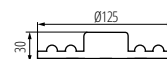

MODv2 LED 12W

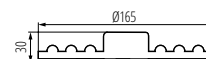

MODv2 LED 19W

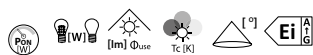

Model	Code	Part No.	Power (W)	Current (A)	Voltage (V)	Beam Angle (°)	Temp. (K)	Life (h)	Beam Dia (mm)
MODv2 LED 12W-WW	29300	5905339293008	12	82	1200	3000	170	F	
MODv2 LED 12W-NW	29301	5905339293015	12	82	1200	4000	170	F	
MODv2 LED 19W-WW	29302	5905339293022	19	120	2000	3000	170	F	
MODv2 LED 19W-NW	29303	5905339293039	19	120	2100	4000	170	E	

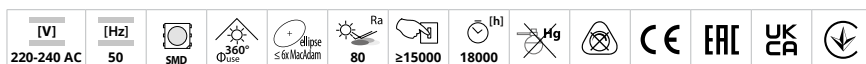

Kanlux LEDS-B

TAŚMA LED ▶ LED TAPE



LEDS-B 4.8W/M IP65



Kanlux LEDS-B to nowoczesne paski o charakterze dekoracyjnym. Idealne do zastosowań domowych, gdzie mogą stworzyć niepowtarzalne aranżacje ograniczone tylko przez naszą wyobraźnię. Charakteryzują się dużą elastycznością, dobrą przychepnością i wysoką trwałością. W zależności od tego jakie miejsca chcemy doświetlić lub podkreślić możemy wybrać odpowiednią do naszych upodobań barwę światła.

Kanlux LEDS-B are modern strips of decorative character. Perfect for home use where they can create unique arrangements limited by our imagination only. They are characterised by high flexibility, good adhesion and high durability. Depending on the place in which we want to add more light or which we wish to highlight, we can choose the light colour suiting our preferences.

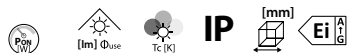

Model	Code	Part No.	0,5m = 2,4	0,5m = 200	3000	65	5000	G
LEDS-B 4,8W/M IP65-VWV	24513	5905339245137	0,5m = 2,4	0,5m = 200	3000	65	5000	G
LEDS-B 4,8W/M IP65-NWV	24514	5905339245144	0,5m = 2,4	0,5m = 220	4000	65	5000	G
LEDS-B 4,8W/M IP65-CWV	24515	5905339245151	0,5m = 2,4	0,5m = 225	6500	65	5000	F
LEDS-B 4,8W/M IP00-VWV	24516	5905339245168	0,5m = 2,4	0,5m = 225	3000	00	5000	F
LEDS-B 4,8W/M IP00-NWV	24517	5905339245175	0,5m = 2,4	0,5m = 235	4000	00	5000	F
LEDS-B 4,8W/M IP00-CWV	24518	5905339245182	0,5m = 2,4	0,5m = 250	6500	00	5000	F

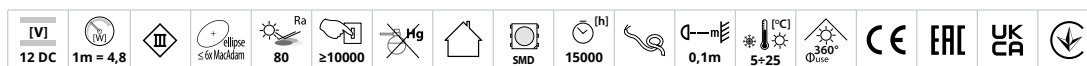

AKCESORIA ▶ ACCESSORIES

CONNECTOR 8	19030	5905339190307	Konektor do taśmy LED, CONNECTOR 8 (19030) LED band connector, CONNECTOR 8 (19030)
CONNECTOR 8-CP	19032	5905339190321	Konektor do taśmy LED, CONNECTOR 8-CP (19032) LED band connector, CONNECTOR 8-CP (19032)
CONNECTOR 8-CPC	19033	5905339190338	Konektor do taśmy LED, CONNECTOR 8-CPC (19033) LED band connector, CONNECTOR 8-CPC (19033)

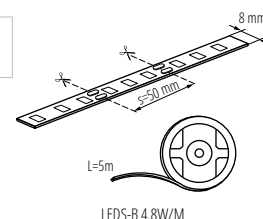

Kanlux

LED STRIP L120 CCT

TAŚMA LED ▶ LED TAPE



L120 16W/M 12 IP00CCT



Taśma Kanlux L120 CCT to trzy barwy światła w jednej taśmie. Teraz możesz zmieniać barwę światła zależnie od sytuacji i nastroju, ponadto Kanlux L120 CCT to bardzo wysoki współczynnik oddawania barw CRI 90 i aż trzy lata gwarancji.

3 lata Gwarancji na warunkach oświadczenia gwarancyjnego, dostępnego na stronie internetowej

Do prawidłowego działania wymagany jest kontroler i pilot (CTRL 12/24V 10A CCT 22142, REMOTE CCT 22145), dostępne one są w ofercie KANLUX

Kanlux L120 CCT LED strip that's three colors of light in one tape. Now you can change the color of the light depending on the situation and mood, in addition, the Kanlux L120 CCT is a very high color rendering factor CRI 90 and up to 3 Year warranty.

3 years Warranty under the terms of the warranty statement, available on our website
Proper controller and remote (CTRL 12/24V 10A CCT 22142, REMOTE CCT 22145) available in Kanlux offer are required for correct operation.



L120 16W/M 12 IP00CCT | **33317** | 5905339333179 | 0,5m = 4 (WW/CW) | 0,5m = 330 (WW/CW) | 3000/6000 | 00 | 5000 | G

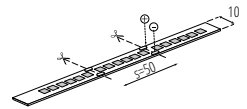

L120 16W/M 12 IP00CCT

[V] 12 DC	[W] 1m = 16	III	ellipse s Gł. Masz. kam	Ra 90	≥30000	Mg	house	SMD
(h) 30000	0,1m	5÷25	360° Φuse	CE	ERC	UK	down arrow	



LED STRIP LCOB 12V

TAŚMA LED ▶ LED TAPE



LCOB 8W/M 12 IP00-WW



LCOB 8W/M 12 IP00-WW



LCOB 8W/M 12 IP00-NW



Taśma LEDowa Kanlux LCOB to wyjątkowe oświetlenie, które ma wysoką skuteczność świetlną i 3 lata gwarancji. Jej unikatową cechą jest równomierne świecenie na całej długości taśmy — nie ma na niej jaśniejszych lub ciemniejszych miejsc, nie widać punktów świetlnych. Taśma Kanlux LCOB emituje równomierne światło niezależnie od głębokości profilu i przezroczystości klosza. Taśmy 12V dla uzyskania najlepszego efektu polecamy używać w odcinkach nie dłuższych niż 2 metry.

3 lata Gwarancji na warunkach oświadczenia gwarancyjnego, dostępnego na stronie internetowej

Kanlux LCOB 8W LED strip is a unique lighting, which has a high luminous efficiency and a 3-year warranty. Its unique feature is a continuous line of light - there are no brighter or darker places on it, no points of light are visible in whole strip. The Kanlux LCOB tape emits uniform light regardless of the profile depth and the transparency of the shade. For the best effect, we recommend using 12V LED strips in sections no longer than 2 meters.

3 years Warranty under the terms of the warranty statement, available on our website

LCOB 8W/M 12 IP00-WW	33364	5905339333643	0,5m = 4	0,5m=360	3000	00	5000	G					
LCOB 8W/M 12 IP65-WW	33365	5905339333650	0,5m = 4	0,5m=340	3000	65	5000	G					
LCOB 8W/M 12 IP00-NW	33366	5905339333667	0,5m = 4	0,5m=380	4000	00	5000	G					
LCOB 8W/M 12 IP65-NW	33367	5905339333674	0,5m = 4	0,5m=360	4000	65	5000	G					
LCOB 10W/M 12 IP00-WW	37230	5905339372307	0,5m = 5	0,5m=460	3000	00	5000	F					
LCOB 10W/M 12 IP00-NW	37231	5905339372314	0,5m = 5	0,5m=500	4000	00	5000	F					
LCOB 10W/M 12 IP65-WW	37232	5905339372321	0,5m = 5	0,5m=430	3000	65	5000	G					
LCOB 10W/M 12 IP65-NW	37233	5905339372338	0,5m = 5	0,5m=475	4000	65	5000	F					

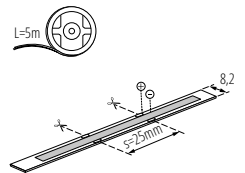

LCOB 8W-M 12 IP65

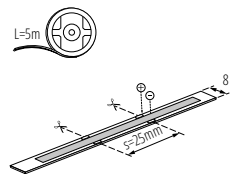

LCOB 8W-M 12 IP00

LEDS-B RGB

TAŚMA LED ▶ LED TAPE



LEDS-B 7.2W/M IP00RGB



Kanlux LEDS-B RGB to nowoczesne paski o charakterze dekoracyjnym. Idealne do zastosowań domowych, gdzie mogą stworzyć niepowtarzalne aranżacje ograniczone tylko przez naszą wyobraźnię. Charakteryzują się dużą elastycznością, dobrą przyczepnością i wysoką trwałością. W zależności od tego jakie miejsca chcemy doświetlić lub podkreślić możemy wybrać odpowiedni do naszych upodobań kolor świecenia.

Kanlux LEDS-B RGB are modern strips of decorative character. Perfect for home use where they can create unique arrangements limited by our imagination only. They are characterised by high flexibility, good adhesion and high durability. Depending on the place in which we want to add more light or which we wish to highlight, we can choose the lighting colour suiting our preferences.



Model	Code	Part 1	Part 2	Part 3	Part 4
LEDS-B 7,2W/M IP00RGB	24530	5905339245304	0,5m = 3,6	0,5m = 65	00 5000
LEDS-B 7,2W/M IP65RGB	24531	5905339245311	0,5m = 3,6	0,5m = 65	65 5000
LEDS-B 7,2W/M IP54RGB	24532	5905339245328	0,5m = 3,6	0,5m = 65	54 5000

12 DC	1m = 7,2	III	TC (K) RGB	≥15000	Mg	SMD	15000	0,1m	5-25	360°	CE	EAC	UK CA	Down Arrow
-------	----------	-----	------------	--------	----	-----	-------	------	------	------	----	-----	-------	------------

AKCESORIA ▶ ACCESSORIES

CONNECTOR RGB 10-CP	19036	5905339190369	Konektor do taśmy LED, CONNECTOR RGB 10-CP (19036) LED band connector, CONNECTOR RGB 10-CP (19036)		
CONNECTOR RGB 10-CPC	19037	5905339190376	Konektor do taśmy LED, CONNECTOR RGB 10-CPC (19037) LED band connector, CONNECTOR RGB 10-CPC (19037)		
CONNECTOR RGB 10	19038	5905339190383	Konektor do taśmy LED, CONNECTOR RGB 10 (19038) LED band connector, CONNECTOR RGB 10 (19038)		
CONTROLLER LED RGB-RF	22140	5905339221407	Kontroler RGB + pilot, CONTROLLER LED RGB-RF (22140) Controller RGB + remote control, CONTROLLER LED RGB-RF (22140)		

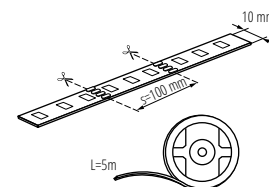

LEDS-B 7,2 W-M P100 RGB; IP65RGB; IP54RGB

LED STRIP L48 RGBW

TAŚMA LED ▶ LED TAPE



L48 9W/M 24 IP00-RGBW



3
WARRANTY
3 years

RGB + W

24V

3M
3M
tape

Kanlux L48 to taśma pozwalająca na swobodną zmianę koloru świecenia. Wyczarujesz dzięki niej dowolne instalacje świetlne i stworzysz wymarzoną atmosferę. Do wyboru masz dwie wersje szczelności IP00 i IP65. Wersja IP65 przeznaczona jest do miejsc gdzie narażona może być na działanie wilgoci, nie różni się ona znacząco gabarytami od wersji IP00 - ma to znaczenie przy montażu w profilach aluminiowych, który nie będzie problemem.

3 lata Gwarancji na warunkach oświadczenia gwarancyjnego, dostępnego na stronie internetowej

Do prawidłowego działania wymagany jest kontroler i pilot (CTRL 12/24V 10A RGBW 22143, REMOTE RGBW 22146), dostępne one są w ofercie KANLUX

Kanlux L48 is a tape that allows you to change the color of the light freely. You will conjure up any light installations and create your dream atmosphere. You can choose between two versions of IP00 and IP65. The IP65 version is designed for places where it can be exposed to moisture, it does not differ significantly in size from the IP00 version - this is important for installation in aluminum profiles, which will not be a problem.

3 years Warranty under the terms of the warranty statement, available on our website
Proper controller and remote (CTRL 12/24V 10A RGBW 22143, REMOTE RGBW 22146) available in Kanlux offer are required for correct operation.

L48 9W/M 24 IP00-RGBW	33318	5905339333186	0,5m =2,3 (W)	0,5m = 240 (W)	1m = max 600 (RGBW)	00	5000	F
L48 9W/M 24 IP65-RGBW	33319	5905339333193	0,5m =2,3 (W)	0,5m = 230 (W)	1m = max 550 (RGBW)	65	5000	F

[V]	[W]	[III]	Tc [K]	allpse	Hg	[h]	[mm]	[Ei A]
24 DC	1m = 9 (RGBW)		RGB + 4000(W)	≤ 6/Maxdam	≥ 30000			
[h]			[°C]	360°	CE	ERC	UK	SMD
30000		0,1m	5+25	Φuse				



L48 9W/M 24 IP00-RGBW



L48 9W/M 24 IP65-RGBW

COB SET

ZESTAW LED ▶ LED KIT



COB SET 3M DIM

3
WARRANTY
3 years

Ra90+
true colors

DIMMING
function

Kanlux COB SET to zestaw składający się z trzech elementów: taśmy LED COB o długości 3m, zasilacza i włącznika z funkcją ściemnia. Jest to gotowy do użycia komplet, który w łatwy sposób zainstalujemy i podłączymy do kontaktu. To wygodne rozwiązanie, które umożliwi dodanie efektownego oświetlenia bez konieczności kucia ścian w celu doprowadzenia dodatkowej instalacji elektrycznej. Dodaotkowo za pomocą włącznika możesz również zmieniać natężenie światła w taśmie LED. Ponadto zastosowana taśma LEC COB to efekt płynnego świecenia na całej długości taśmy, bez widocznych punktów świetlnych.

3 lata Gwarancji na warunkach oświadczenia gwarancyjnego, dostępnego na stronie internetowej

Kanlux COB SET is a set consisting of three elements: a 3m long LED strip, a power supply and a switch with a dimmer function. It is a ready-to-use set that can be easily installed and connected to the socket. This is a convenient solution that allows you to add effective lighting without the need to cut walls for additional electrical wiring.

3 years Warranty under the terms of the warranty statement, available on our website

COB SET 3m DIM-WW	26326	5905339263261	0,5m = 4	0,5m = 360	3000	00	3000	G
COB SET 3m DIM-NW	26327	5905339263278	0,5m = 4	0,5m = 380	4000	00	3000	F

[V]	[Hz]	PRI [V]	SEC [V]	[W]	[h]	[mm]	[Ra]	Hg	DIMMING function
220-240 AC	50	220-240 AC	12 DC	3m=18	30000		90	≥ 30000	
[h]				360°	CE	ERC	UK		
30000		0,1m		Φuse					

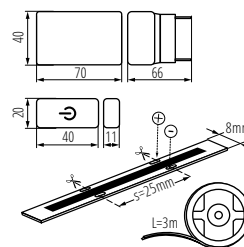

COB SET 3M DIM

CONTROLLER MONO/CCT

KONTROLER DO TAŚM LED ► CONTROLLER FOR LED TAPES



CTRL 12/24V MONO/CCT



REMOTE MONO



REMOTE CCT

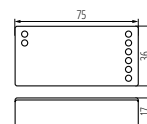

CTRL 12/24V MONO/CCT



CTRL 12/24V MONO/CCT	22147	5905339221476	biały white	12 DC; 24 DC	max 10	max 30
REMOTE MONO	22144	5905339221445	biały white	2 x 1,5 DC	2 x AAA	max 30
REMOTE CCT	22145	5905339221452	biały white	2 x 1,5 DC	2 x AAA	max 30

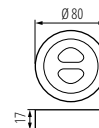

REMOTE MONO

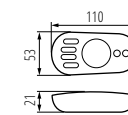

REMOTE CCT

CONTROLLER RGBW CCT

KONTROLER DO TAŚM LED ► CONTROLLER FOR LED TAPES



CTRL 12/24V RGBW CCT



REMOTE RGBW



CTRL 12/24V RGBW CCT	22148	5905339221483	biały white	12 DC; 24 DC	max 10	max 30
REMOTE RGBW	22146	5905339221469	biały white	2 x 1,5 DC	2 x AAA	max 30

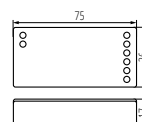

CTRL 12/24V RGBW CCT

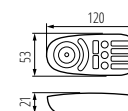

REMOTE RGBW

Kontroler współpracuje z jednokolorowymi taśmami LED oraz taśmami LED RGB/RGBW. Może współpracować z pilotami RGB/CCT.

Pilot RGBW 4 kanałowy

Materiał: tworzywo sztuczne

Contolrer works with one color and RG B/RG BW LED STRI PS. It can work with RGB/CCT remote controls.

4-channel remote RGBW

Materiał: plastic

PROFILO B

PROFIL ALUMINIOWY ► ALUMINIUM PROFILE



PROFILO B



Mały, nawierzchniowy uniwersalny profil dekoracyjno-oświetleniowy

Materiał: stop aluminium

Small, surface, multi-purpose decorative lighting profile

Materiał: aluminium alloy



PROFILO B	19161	5905339191618	anodowany anodised	1000
PROFILO B 2m	26540	5905339265401	anodowany anodised	2000

AKCESORIA ► ACCESSORIES

SHADE B/F-FR	26568	5905339265685	Klosz szroniony do profilu aluminiowego, komplet 10 szt., SHADE B/F-FR(26568) Frosted light cover for aluminium profile, package 10 pcs., SHADE B/F-FR(26568)
SHADE B/F-FR 2M	26570	5905339265708	Klosz szroniony do profilu aluminiowego, komplet 10 szt., SHADE B/F-FR 2M(26570) Frosted light cover for aluminium profile, package 10 pcs., SHADE B/F-FR 2M(26570)
SHADE B/F-W	26569	5905339265692	Klosz biały do profilu aluminiowego, komplet 10 szt., SHADE B/F-W(26569) White shade for aluminium profile, package 10 pcs., SHADE B/F-W(26569)
SHADE B/F-W 2M	26571	5905339265715	Klosz biały do profilu aluminiowego, komplet 10 szt., SHADE B/F-W 2M(26571) White shade for aluminium profile, package 10 pcs., SHADE B/F-W 2M(26571)
HANDLE B/F	26596	5905339265968	Uchwyt mocujący profil aluminiowy, HANDLE B/F (26596) Aluminium profile mounting bracket, HANDLE B/F (26596)
CONNECT-L B	26604	5905339266040	Łącznik do profilu aluminiowego, CONNECT-L B (26604) Aluminium profile connector, CONNECT-L B (26604)
STOPPER B	19181	5905339191816	Zasłepka do profilu aluminiowego, STOPPER B (19181) Aluminium profile cap, STOPPER B (19181)

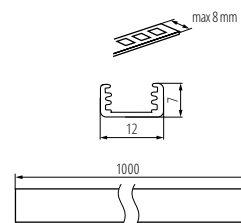

PROFILO B

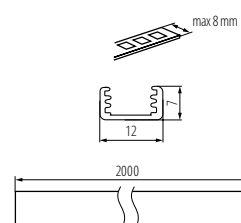

PROFILO B 2M



PROFILO C



PROFILO C	19162	5905339191625	anodowany anodised	1000
PROFILO C 2m	26541	5905339265418	anodowany anodised	2000

AKCESORIA ► ACCESSORIES

SHADE C/D/E/I-FR	26572	5905339265722	Klosz szroniony do profilu aluminiowego, komplet 10 szt., SHADE C/D/E/I-FR(26572) Frosted light cover for aluminium profile, package 10 pcs., SHADE C/D/E/I-FR(26572)
SHADE C/D/E/I-FR2M	26573	5905339265739	Klosz szroniony do profilu aluminiowego, komplet 10 szt., SHADE C/D/E/I-FR 2M(26573) Frosted light cover for aluminium profile, package 10 pcs., SHADE C/D/E/I-FR 2M(26573)
SHADE C/D/E/I-W	26574	5905339265746	Klosz biały do profilu aluminiowego, komplet 10 szt., SHADE C/D/E/I-W(26574) White shade for aluminium profile, package 10 pcs., SHADE C/D/E/I-W(26574)
SHADE C/D/E/I-W 2M	26575	5905339265753	Klosz biały do profilu aluminiowego, komplet 10 szt., SHADE C/D/E/I-W 2M(26575) White shade for aluminium profile, package 10 pcs., SHADE C/D/E/I-W 2M(26575)
SHADE CK C/D/E/I-FR	26576	5905339265760	Klosz transparentny do profilu aluminiowego, komplet 10 szt., SHADE CK C/D/E/I-FR(26576) Transparent light cover for aluminium profile, package 10 pcs., SHADE CK C/D/E/I-FR(26576)
SHADE CK C/D/E/I-FR2M	26577	5905339265777	Klosz transparentny do profilu aluminiowego, komplet 10 szt., SHADE CK C/D/E/I-FR2M(26577) Transparent light cover for aluminium profile, package 10 pcs., SHADE CK C/D/E/I-FR2M(26577)
SHADE CK C/D/E/I-W	26578	5905339265784	Klosz biały do profilu aluminiowego, komplet 10 szt., SHADE CK C/D/E/I-W(26578) White shade for aluminium profile, package 10 pcs., SHADE CK C/D/E/I-W(26578)
SHADE CK C/D/E/I-W 2M	26579	5905339265791	Klosz biały do profilu aluminiowego, komplet 10 szt., SHADE CK C/D/E/I-W 2M(26579) White shade for aluminium profile, package 10 pcs., SHADE CK C/D/E/I-W 2M(26579)
HANDLE C/D/E/I	26597	5905339265975	Uchwyt mocujący profil aluminiowy, HANDLE C/D/E/I (26597) Aluminium profile mounting bracket, HANDLE C/D/E/I (26597)
CONNECT C/D/E/I	26563	5905339265630	Łącznik do profilu aluminiowego, CONNECT C/D/E/I(26563) Aluminium profile connector, CONNECT C/D/E/I(26563)
CONNECT-L C	26562	5905339265623	Łącznik do profilu aluminiowego, CONNECT-L C(26562) Aluminium profile connector, CONNECT-L C(26562)
STOPPER C	19182	5905339191823	Zasłepka do profilu aluminiowego, STOPPER C (19182) Aluminium profile cap, STOPPER C (19182)

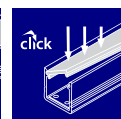
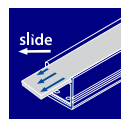

Kątowy (30° i 60°) profil dekoracyjno-oświetleniowy

Materiał: stop aluminium

Angular (30° and 60°) decorative lighting profile

Materiał: aluminium alloy



slide

click

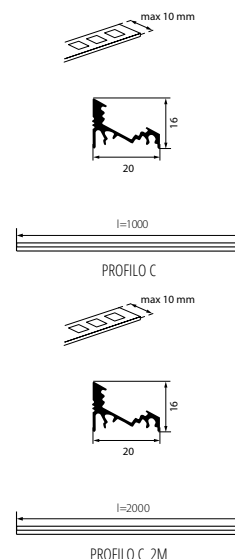

PROFILO D

PROFIL ALUMINIOWY ► ALUMINIUM PROFILE



PROFILO D

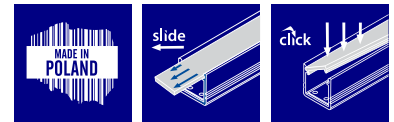

Nawierzchniowy profil dekoracyjno-oświetleniowy

Materiał: stop aluminium

Surface decorative lighting profile

Material: aluminum alloy



PROFILO D	19163	5905339191632	anodowany anodised	1000
PROFILO D 2m	26542	5905339265425	anodowany anodised	2000

AKCESORIA ► ACCESSORIES

SHADE C/D/E/I-FR	26572	5905339265722	Klosz szroniony do profilu aluminiowego, komplet 10 szt., SHADE C/D/E/I-FR(26572) Frosted light cover for aluminium profile, package 10 pcs., SHADE C/D/E/I-FR(26572)
SHADE C/D/E/I-FR2M	26573	5905339265739	Klosz szroniony do profilu aluminiowego, komplet 10 szt., SHADE C/D/E/I-FR 2M(26573) Frosted light cover for aluminium profile, package 10 pcs., SHADE C/D/E/I-FR 2M(26573)
SHADE C/D/E/I-W	26574	5905339265746	Klosz biały do profilu aluminiowego, komplet 10 szt., SHADE C/D/E/I-W(26574) White shade for aluminium profile, package 10 pcs., SHADE C/D/E/I-W(26574)
SHADE C/D/E/I-W2M	26575	5905339265753	Klosz biały do profilu aluminiowego, komplet 10 szt., SHADE C/D/E/I-W 2M(26575) White shade for aluminium profile, package 10 pcs., SHADE C/D/E/I-W 2M(26575)
SHADE CK C/D/E/I-FR	26576	5905339265760	Klosz transparentny do profilu aluminiowego, komplet 10 szt., SHADE CK C/D/E/I-FR(26576) Transparent light cover for aluminium profile, package 10 pcs., SHADE CK C/D/E/I-FR(26576)
SHADE CK C/D/E/I-FR2M	26577	5905339265777	Klosz transparentny do profilu aluminiowego, komplet 10 szt., SHADE CK C/D/E/I-FR2M(26577) Transparent light cover for aluminium profile, package 10 pcs., SHADE CK C/D/E/I-FR2M(26577)
SHADE CK C/D/E/I-W	26578	5905339265784	Klosz biały do profilu aluminiowego, komplet 10 szt., SHADE CK C/D/E/I-W(26578) White shade for aluminium profile, package 10 pcs., SHADE CK C/D/E/I-W(26578)
SHADE CK C/D/E/I-W2M	26579	5905339265791	Klosz biały do profilu aluminiowego, komplet 10 szt., SHADE CK C/D/E/I-W 2M(26579) White shade for aluminium profile, package 10 pcs., SHADE CK C/D/E/I-W 2M(26579)
HANDLE C/D/E/I	26597	5905339265975	Uchwyt mocujący profil aluminiowy, HANDLE C/D/E/I (26597) Aluminium profile mounting bracket, HANDLE C/D/E/I (26597)
CONNECT C/D/E/I	26563	5905339265630	Łącznik do profilu aluminiowego, CONNECT C/D/E/I(26563) Aluminium profile connector, CONNECT C/D/E/I(26563)
STOPPER D	19183	5905339191830	Zasłepka do profilu aluminiowego, STOPPER D (19183) Aluminium profile cap, STOPPER D (19183)

slide

click

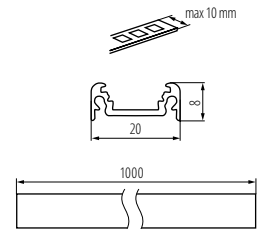

PROFILO D

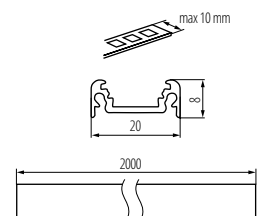

PROFILO D 2M

PROFILO F

PROFIL ALUMINIOWY ► ALUMINIUM PROFILE



PROFILO F



Uniwersalny profil dekoracyjno-oświetleniowy

Materiał: stop aluminium

Multi-purpose decorative lighting profile

Materiał: aluminium alloy



PROFILO F	26552	5905339265524	anodowany anodised	1000
PROFILO F 2m	26553	5905339265531	anodowany anodised	2000

AKCESORIA ► ACCESSORIES

SHADE B/F-FR	26568	5905339265685	Klosz szroniony do profilu aluminiowego, komplet 10 szt., SHADE B/F-FR(26568) Frosted light cover for aluminium profile, package 10 pcs., SHADE B/F-FR(26568)
SHADE B/F-FR 2M	26570	5905339265708	Klosz szroniony do profilu aluminiowego, komplet 10 szt., SHADE B/F-FR 2M(26570) Frosted light cover for aluminium profile, package 10 pcs., SHADE B/F-FR 2M(26570)
SHADE B/F-W	26569	5905339265692	Klosz biały do profilu aluminiowego, komplet 10 szt., SHADE B/F-W(26569) White shade for aluminium profile, package 10 pcs., SHADE B/F-W(26569)
SHADE B/F-W 2M	26571	5905339265715	Klosz biały do profilu aluminiowego, komplet 10 szt., SHADE B/F-W 2M(26571) White shade for aluminium profile, package 10 pcs., SHADE B/F-W 2M(26571)
HANDLE B/F	26596	5905339265968	Uchwyt mocujący profil aluminiowy, HANDLE B/F (26596) Aluminium profile mounting bracket, HANDLE B/F (26596)
STOPPER F	26590	5905339265906	Zasłepki do profilu aluminiowego, STOPPER F (26590) Aluminium profile caps, STOPPER F (26590)

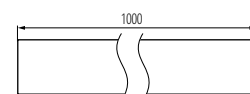
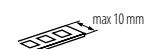

PROFILO F

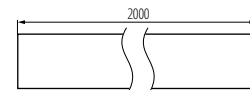
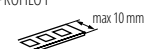

PROFILO F 2M

PROFILO G

PROFIL ALUMINIOWY ► ALUMINIUM PROFILE



PROFILO G



Wpustowy profil dekoracyjno-oświetleniowy do podłóg

Materiał: stop aluminium

Recessed decorative lighting profile

Materiał: aluminium alloy



PROFILO G	26558	5905339265586	anodowany anodised	1000
PROFILO G 2m	26559	5905339265593	anodowany anodised	2000

AKCESORIA ► ACCESSORIES

SHADE CK G	26580	5905339265807	Klosz biały do profilu aluminiowego, komplet 10 szt., SHADE CK G(26580) White shade for aluminium profile, package 10 pcs., SHADE CK G(26580)	} click
SHADE CK G 2M	26581	5905339265814	Klosz biały do profilu aluminiowego, komplet 5 szt., SHADE CK G 2M(26581) White shade for aluminium profile, package 5 pcs., SHADE CK G 2M(26581)	
HANDLE G	26598	5905339265982	Uchwyt mocujący profil aluminiowy, HANDLE G (26598) Aluminium profile mounting bracket, HANDLE G (26598)	
STOPPER G	26592	5905339265920	Zasłepki do profilu aluminiowego, STOPPER G (26592) Aluminium profile caps, STOPPER G (26592)	
SEALINGS G	26602	5905339266026	Uszczelka do profilu aluminiowego, SEALINGS G (26602) Aluminium profile gasket, SEALINGS G (26602)	

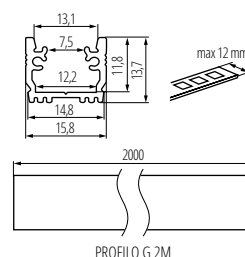
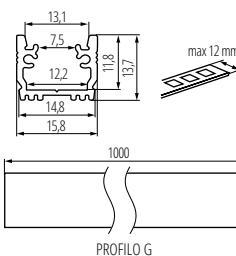

PROFILO H

PROFIL ALUMINIOWY ► ALUMINIUM PROFILE



PROFILO H



PROFILO H	26560	5905339265609	anodowany anodised	1000
PROFILO H 2m	26561	5905339265616	anodowany anodised	2000

AKCESORIA ► ACCESSORIES

SHADE-O H-W	26586	5905339265869	Klosz biały do profilu aluminiowego, komplet 10 szt., SHADE-O H-W(26586) White shade for aluminium profile, package 10 pcs., SHADE-O H-W(26586)
SHADE-O H-W 2m	26587	5905339265876	Klosz biały do profilu aluminiowego, komplet 5 szt., SHADE-O H-W 2m(26587) White shade for aluminium profile, package 5 pcs., SHADE-O H-W 2m(26587)
SHADE-U H-FR	26582	5905339265821	Klosz transparentny do profilu aluminiowego, komplet 10 szt., SHADE-U H-FR(26582) Transparent light cover for aluminium profile, package 10 pcs., SHADE-U H-FR(26582)
SHADE-U H-FR 2m	26583	5905339265838	Klosz transparentny do profilu aluminiowego, komplet 5 szt., SHADE-U H-FR 2m(26583) Transparent light cover for aluminium profile, package 5 pcs., SHADE-U H-FR 2m(26583)
SHADE-U H-W	26584	5905339265845	Klosz do profilu aluminiowego, komplet 10 szt., SHADE-U H-W(26584) Shade for aluminium profile, package 10 pcs., SHADE-U H-W(26584)
SHADE-U H-W 2m	26585	5905339265852	Klosz biały do profilu aluminiowego, komplet 5 szt., SHADE-U H-W 2m(26585) White shade for aluminium profile, package 5 pcs., SHADE-U H-W 2m(26585)
HANDLE H	26599	5905339265999	Uchwyt mocujący profil aluminiowy, HANDLE H (26599) Aluminium profile mounting bracket, HANDLE H (26599)
HANDLE SIDE H	26600	5905339266002	Uchwyt mocujący profil aluminiowy, HANDLE SIDE H (26600) Aluminium profile mounting bracket, HANDLE SIDE H (26600)
STOPPER-U H	26593	5905339265937	Zaślepki do profilu aluminiowego, STOPPER-U H (26593) Aluminium profile caps, STOPPER-U H (26593)
STOPPER-O H	26594	5905339265944	Zaślepki do profilu aluminiowego, STOPPER-O H (26594) Aluminium profile caps, STOPPER-O H (26594)

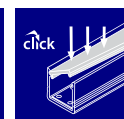

Profil dekoracyjno-oświetleniowy do zastosowań giętych w dwóch kierunkach jednej płaszczyzny

Materiał: stop aluminium

Flexible decorative lighting profile - possibilities of bending in two directions

Materiał: aluminium alloy

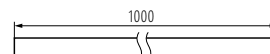
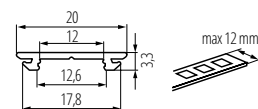

PROFILO H

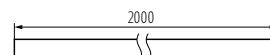
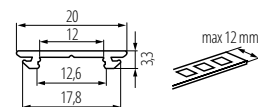

PROFILO H 2M

PROFILO J

PROFIL ALUMINIOWY ► ALUMINIUM PROFILE



PROFILO J



PROFILO J-W

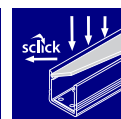

Nawierzchniowy profil dekoracyjno-oświetleniowy

Materiał: stop aluminium

Surface decorative lighting profile

Materiał: aluminum alloy



PROFILO J	26544	5905339265449	anodowany anodised	1000
PROFILO J 2M	26545	5905339265456	anodowany anodised	2000
PROFILO J-W	26546	5905339265463	biały white	1000
PROFILO J-W 2M	26547	5905339265470	biały white	2000

AKCESORIA ► ACCESSORIES

SHADE J/K-FR	26564	5905339265647	Klosz szroniony do profilu aluminiowego, komplet 10 szt., SHADE J/K-FR(26564) Frosted light cover for aluminium profile, package 10 pcs., SHADE J/K-FR(26564)
SHADE J/K-FR 2m	26566	5905339265661	Klosz szroniony do profilu aluminiowego, komplet 10 szt., SHADE J/K-FR 2m(26566) Frosted light cover for aluminium profile, package 10 pcs., SHADE J/K-FR 2m(26566)
SHADE J/K-W	26565	5905339265654	Klosz biały do profilu aluminiowego, komplet 10 szt., SHADE J/K-W(26565) White shade for aluminium profile, package 10 pcs., SHADE J/K-W(26565)
SHADE J/K-W 2m	26567	5905339265678	Klosz biały do profilu aluminiowego, komplet 10 szt., SHADE J/K-W 2m(26567) White shade for aluminium profile, package 10 pcs., SHADE J/K-W 2m(26567)
HANDLE J/K	26595	5905339265951	Uchwyt mocujący profil aluminiowy, HANDLE J/K (26595) Aluminium profile mounting bracket, HANDLE J/K (26595)
STOPPER J	26588	5905339265883	Zaślepki do profilu aluminiowego, STOPPER J (26588) Aluminium profile caps, STOPPER J (26588)
STOPPER J-W	26605	5905339266057	Zaślepki do profilu aluminiowego, STOPPER J-W (26605) Aluminium profile caps, STOPPER J-W (26605)

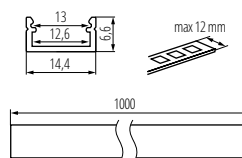

PROFILO J; J-W

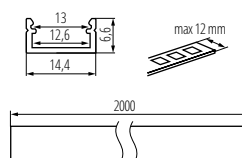

PROFILO J; J-W 2M

PROFILO K

PROFIL ALUMINIOWY ► ALUMINIUM PROFILE



PROFILO K



PROFILO K-W

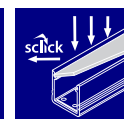

Wpustowy profil dekoracyjno-oświetleniowy

Materiał: stop aluminium

Recessed decorative lighting profile

Materiał: aluminium alloy



PROFILO K	26548	5905339265487	anodowany anodised	1000
PROFILO K.2m	26549	5905339265494	anodowany anodised	2000
PROFILO K-W	26550	5905339265500	biały white	1000
PROFILO K-W.2m	26551	5905339265517	biały white	2000

AKCESORIA ► ACCESSORIES

SHADE J/K-FR	26564	5905339265647	Klosz szroniony do profilu aluminium, komplet 10 szt., SHADE J/K-FR(26564) Frosted light cover for aluminium profile, package 10 pcs., SHADE J/K-FR(26564)
SHADE J/K-FR.2m	26566	5905339265661	Klosz szroniony do profilu aluminium, komplet 10 szt., SHADE J/K-FR.2m(26566) Frosted light cover for aluminium profile, package 10 pcs., SHADE J/K-FR.2m(26566)
SHADE J/K-W	26565	5905339265654	Klosz biały do profilu aluminium, komplet 10 szt., SHADE J/K-W(26565) White shade for aluminium profile, package 10 pcs., SHADE J/K-W(26565)
SHADE J/K-W.2m	26567	5905339265678	Klosz biały do profilu aluminium, komplet 10 szt., SHADE J/K-W.2m(26567) White shade for aluminium profile, package 10 pcs., SHADE J/K-W.2m(26567)
HANDLE J/K	26595	5905339265951	Uchwyt mocujący profil aluminium, HANDLE J/K (26595) Aluminium profile mounting bracket, HANDLE J/K (26595)
STOPPER K	26589	5905339265890	Zasłepki do profilu aluminium, STOPPER K (26589) Aluminium profile caps, STOPPER K (26589)
STOPPER K-W	26606	5905339266064	Zasłepki do profilu aluminium, STOPPER K-W (26606) Aluminium profile caps, STOPPER K-W (26606)

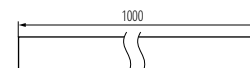
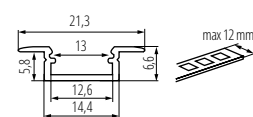

PROFILO K; K-W

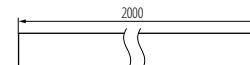
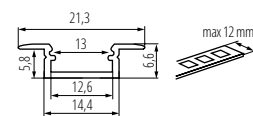

PROFILO K; K-W.2M

NEON LED12W/M

NEON LED ► NEON LED

NEW



NEON LED12W/M IP65

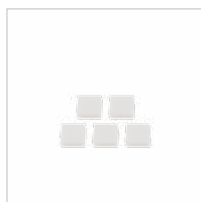

NEON END CAP



NEON END CAP HOLE

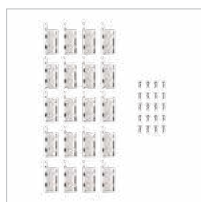

NEON MOUNTING CLIP



NEON LED12W/M IP65-VWV	37234	5905339372345	0,5m = 6	0,5m=110	2700	6	ciepłobiała Warm white	80	5000
NEON LED12W/M IP65-NWV	37235	5905339372352	0,5m = 6	0,5m=160	4000	6	biała white	80	5000
NEON LED12W/M IP65-CWV	37236	5905339372369	0,5m = 6	0,5m=120	5700	6	chłodnobiała cold white	80	5000
NEON LED12W/M IP65-BLV	37237	5905339372376	0,5m = 6	0,5m=20	-	-	niebieska blue	-	5000

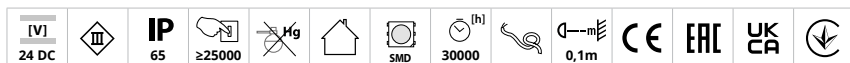

NEON END CAP	37239	5905339372390	Zaślepka do NEON LED, NEON END CAP (37239). NEON LED cap, NEON END CAP (37239).						
NEON END CAP HOLE	37238	5905339372383	Zaślepka do NEON LED, NEON END CAP HOLE (37238). NEON LED cap, NEON END CAP HOLE (37238).						
NEON MOUNTING CLIP	37229	5905339372291	Uchwyt montażowy do NEON LED, NEON MOUNTING CLIP (37229). Mounting bracket for NEON LED, NEON MOUNTING CLIP (37229).						



Kanlux NEON LED to wyjątkowe taśmy LED dostępne w trzech temperaturach barwowych: biała zimna, biała ciepła i biała neutralna i w kolorze niebieskim. Cechują się wodoodpornością (IP65) i wyjątkową sprężystością. Ich zaletą jest równomierne świecenie na całej długości (nie widać punktów świetlnych) i 3 lata gwarancji. Kanlux NEON LED to bardzo jasne światło, które z powodzeniem wykorzystamy nie tylko do użytku domowego czy komercyjnego, ale także jako NEONY reklamowe. Ich giętkość i elastyczność pozwala na ułożenie z nich praktycznie niczym nieograniczonych kształtów. Każda taśma Kanlux NEON LED ma 5 metrów długości i zasilana jest napięciem 24V.

3 lata gwarancji na warunkach oświadczenia gwarancyjnego, dostępnego na stronie internetowej
 Niedozwolone jest łączenie pasmów LED w odcinek dłuższy niż 5m. Aplikacje wymagające zastosowania dłuższych odcinków powinny być elektrycznie podzielone (połączone równolegle) na cztery o długości max 5m.

Kanlux NEON LED zakończony jest gniazdem, które można łączyć z dodaną do opakowania wtyczką z przewodem do łatwego montażu.

Kanlux NEON LED are unique LED strips available in three color temperatures: cold white, warm white, neutral white and blue. They are waterproof (IP65) and exceptionally flexible. Their advantage is uniform illumination along the entire length (no light points visible) and a 3-year warranty. Kanlux NEON LED is a very bright light that can be successfully used not only for home or commercial use, but also as advertising NEONS. Their flexibility and elasticity allow them to be formed into virtually unlimited shapes. Each Kanlux NEON LED strip is 5 meters long and is powered by 24V.

3 years Warranty under the terms of the warranty statement, available on our website

Linking LED strips into a section exceeding 5 m is not permitted. Applications requiring longer sections should be electrically divided (connected in parallel) into sections not exceeding 5 m in length.

Kanlux NEON LED is equipped with a socket that can be connected to the plug with a cable included in the package for easy installation.

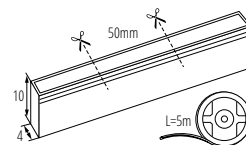

NEON LED12W-M IP65

Kanlux

NEON LED12W/M

NEON LED ► NEON LED



NEON LED12W/M IP65-WW

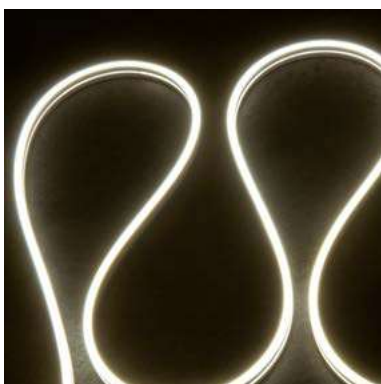

NEON LED12W/M IP65-NW

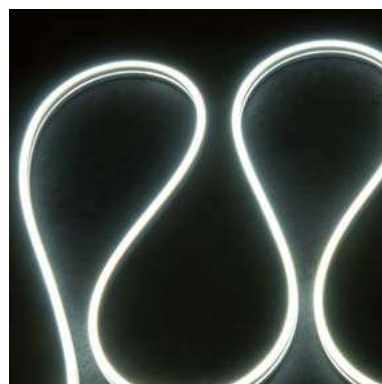

NEON LED12W/M IP65-CW

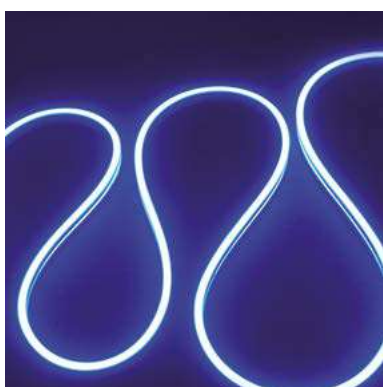

NEON LED12W/M IP65-BL



Kanlux

XLED HP D9

ŹRÓDŁO ŚWIATŁA LED ▶ LED LIGHT SOURCE

NEW



XLED HP D90E27 26W



Kanlux XLED HP D90E27 to LEDowy odpowiednik specjalistycznych żarówek halogenowych o trzonku E27. To profesjonalne źródło światła ma skuteczność świetlną ponad 150lm/w co sprawia, że jest wydajniejsza od swoich halogenowych poprzedników i pomaga oszczędzać wydatki na energię elektryczną. Ponadto jej trwałość wynosi 25.000 godzin.

3 lata gwarancji na warunkach oświadczenia gwarancyjnego, dostępnego na stronie internetowej

Produkt spełnia wymagania IP65 za wyjątkiem trzonka lampy, zastosowania zewnętrzne wymagają stosowania lampy w oprawkach o odpowiednim stopniu ochrony IP. Trzonek lampy należy zamontować w gnieździe o odpowiednim stopniu ochrony IP.

Materiał klosza: szkło

Kanlux XLED HP D90E27 is the LED equivalent of specialised halogen bulbs with an E27 cap. This professional light source has a luminous efficacy of over 150lm/w making it more efficient than its halogen antecedent and helping to save on electricity expenses. In addition, it has a service life of 25,000 hours.

3 years Warranty under the terms of the warranty statement, available on our website

The product fulfills IP65 requirements except lamp cap, outdoor applications require the lamp to be used in luminaires with suitable IP rating. Lamp cap needs to be installed in correct IP rated socket.

Lampshade material: glass

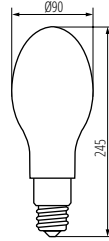

XLED HP D90E27 26W



XLED HP D90E27 26W-NW | 37346 | 5905339373465 | 26 | 227 | 4000 | 4000 | 320 | E27 | D

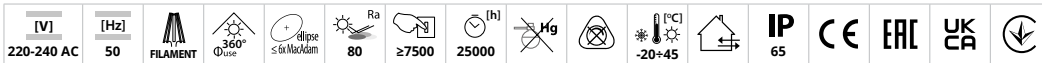

Kanlux

XLED HP D46

ŹRÓDŁO ŚWIATŁA LED ▶ LED LIGHT SOURCE

NEW



XLED HP D46E40 38W

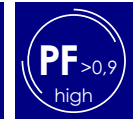

Kanlux XLED HP D46E40 to LEDowy odpowiednik specjalistycznych żarówek halogenowych o trzonku E40. To profesjonalne źródło światła ma skuteczność świetlną bliską prawie 200lm/w co sprawia, że jest ponad 10 razy wydajniejsza od swoich halogenowych poprzedników. Ponadto jej trwałość wynosi 25.000 godzin.

3 lata gwarancji na warunkach oświadczenia gwarancyjnego, dostępnego na stronie internetowej

Produkt spełnia wymagania IP65 za wyjątkiem trzonka lampy, zastosowania zewnętrzne wymagają stosowania lampy w oprawkach o odpowiednim stopniu ochrony IP. Trzonek lampy należy zamontować w gnieździe o odpowiednim stopniu ochrony IP.

Materiał klosza: szkło

Kanlux XLED HP D90E27 is the LED equivalent of specialised halogen bulbs with an E27 cap. This professional light source has a luminous efficacy of over 150lm/w making it more efficient than its halogen antecedent and helping to save on electricity expenses. In addition, it has a service life of 25,000 hours.

3 years Warranty under the terms of the warranty statement, available on our website

The product fulfills IP65 requirements except lamp cap, outdoor applications require the lamp to be used in luminaires with suitable IP rating. Lamp cap needs to be installed in correct IP rated socket.

Lampshade material: glass



XLED HP D90E27 26W



XLED HP D46E40 38W-NW | 37347 | 5905339373472 | 38 | 402 | 7500 | 4000 | 320 | E40 | B

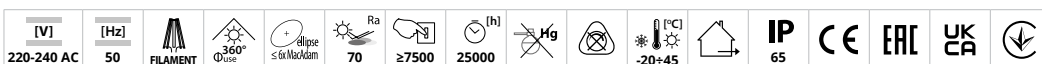

Kanlux G9 STAR

HALOGENOWE ŹRÓDŁO ŚWIATŁA ► HALIDE LIGHT SOURCE

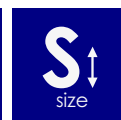

G9-20W; 33W; 48W; 60W STAR

Kanlux G9 STAR to żarówka halogenowa z trzonkiem G9.

Materiał: stop metali niekorodujących

Materiał klosza: szkło

Kanlux G9 STAR is a halogen bulb with G9 light bulb base.

Material: non-corrosive metals alloy

Lampshade material: glass

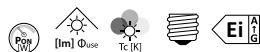

	Power [W]	Part No.	Φ _{use} [lm]	Tc [K]	Life [h]	Base	Beam
G9-20W STAR	18420	5905339184207	20	235	2700	G9	G
G9-33W STAR	18421	5905339184214	33	460	2700	G9	G
G9-48W STAR	18422	5905339184221	48	740	2700	G9	G
G9-60W STAR	18423	5905339184238	60	975	2700	G9	G

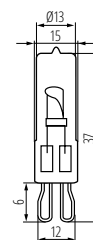

G9-20W; 33W; 48W; 60W STAR

[V]	[Hz]	360°	[h]	Ra	≥8000	Hg	CE	ERL	UK	↓
220-240 AC	50	Φ _{use}	2000	100						

Kanlux J

HALOGENOWE ŹRÓDŁO ŚWIATŁA ► HALIDE LIGHT SOURCE



J-1000W 189MM



Projektowe żarówki halogenowe, przeznaczone są do lamp i halopaków na gwint R7s. Dostępne moce to od 1000W aż do 1500W. Przeznaczone są do pracy w poziomie.

przeznaczone do pracy w poziomie, dopuszczalny odchył pozycji pracy +/-4°

Materiał klosza: szkło

The designed halogen bulbs are intended for lamps and halopaks with R7s thread. Available power from 1000W to 1500W. They are meant for horizontal work.

designed for horizontal operation, allowable deflection of working position +/-4°

Lampshade material: glass

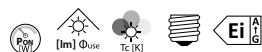

	Power [W]	Part No.	Life [h]	Beam	Base	Beam
J-1000W 189MM	10418	5905339104182	1000	16000	2700	R7s G

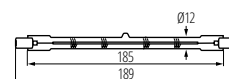

J-1000W 189MM

[V]	[Hz]	360°	[h]	Ra	≥8000	Hg	CE	ERL	UK	↓
220-240 AC	50	Φ _{use}	2000	100						

Kanlux J STAR

HALOGENOWE ŹRÓDŁO ŚWIATŁA ► HALIDE LIGHT SOURCE



J-80W 78MM STAR

J-80W 78MM STAR	08490	5905339084903	80	1380	2700	R7s G
J-120W 78MM STAR	08491	5905339084910	120	2230	2700	R7s G
J-120W 118MM STAR	08500	5905339085009	120	2230	2700	R7s G

220-240 AC	50	360°	2000	100	≥8000				



Projektowe żarówki halogenowe, przeznaczone są do lamp i halopaków na gwint R7s. Dostępne moce to od 80W aż do 400W. Przeznaczone są do pracy w poziomie.

strumień świetlny większy średnio o 23%, przy zużyciu prądu mniejszym o 20% (w porównaniu z halogenem w klasie F)

przeznaczone do pracy w poziomie, dopuszczalny odchył pozycji pracy +/-4°

Materiał klosza: szkło

The designed halogen bulbs are intended for lamps and halopaks with R7s thread. Available power from 80W to 400W. They are meant for horizontal work.

23% more light flux by 20% lower power consumption (compared to F class halogen) designed for horizontal operation, allowable deflection of working position +/-4°

Lampshade material: glass

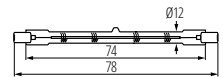

J-80W; 120W 78MM STAR



J-120W; 160W; 230W; 400W 118MM STAR

Kanlux T5

ŚWIETŁÓWKI LINIOWE ► LINEAR FLUORESCENT LAMP



T5-8W 4000K/65

T5-8W 4000K/65	12715	5905339127150	8	688	4000	G5 G
T5-13W 4000K/65	12716	5905339127167	13	1118	4000	G5 G
T5-14W 4000K/82	12717	5905339127174	14	1204	4000	G5 G

--	--	--	--	--	--



Kanlux T5 to jedno i trójpasemowe świetlówki liniowe. Niskie zużycie energii i długi czas pracy to niewątpliwe zalety tych lamp.

T5-8W, T5-13W: świetlówki jednopasmowe, pozostałe modele to świetlówki trójpasemowe

Materiał: szkło

Kanlux T5 are oneband and triband linear fluorescent lamps. Low consumption of energy and long working time are indisputable advantages of these lamps.

T5-8W, T5-13W: fluorescent lamps, other models are tri-band fluorescent

Materiał: glass

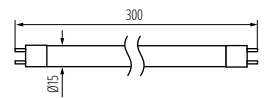

T5-8W 4000K/65

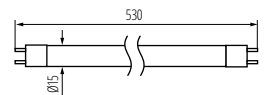

T5-13W 4000K/65

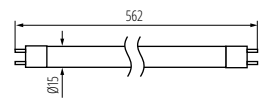

T5-14W 4000K/82

Kanlux

T8

ŚWIETŁÓWKA LINIOWA ► LINEAR FLUORESCENT LAMP



T8 36W



T8 18W/840 NW	19921	5905339199218	18	1350	4000	G13	G
T8 18W/865 CW	19922	5905339199225	18	1250	6500	G13	G
T8 36W/840 NW	19924	5905339199249	36	3350	4000	G13	F
T8 36W/865 CW	19925	5905339199256	36	3050	6500	G13	G



Kanlux T8 to trójpasemowe świetlówki liniowe. Niskie zużycie energii i długi czas pracy (15.000H) to niewątpliwe zalety tych lamp.

Materiał: szkło

Kanlux T8 are triband linear fluorescent lamps. Low consumption of energy and long working time (15.000H) are indisputable advantages of these lamps.

Material: glass

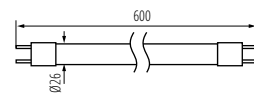

T8 18W

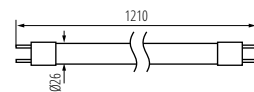

T8 36W

Kanlux

MHE

LAMPA METALOHALOGENKOWA ► METAL-HALIDE LAMP



MHE-250W/4200K



MHE-250W/4200K	12755	5905339127556	250	23000	4200	E40	12000	F
MHE-400W/4200K	12756	5905339127563	400	38000	4200	E40	10000	F



Lampy metalohalogenkowe Kanlux MHE pracują ze statecznikami do wysokopięrnych lamp sodowych/ lamp metalohalogenkowych i zapłonnikami do lamp metalohalogenkowych.

Materiał: szkło

Kanlux MHE metal-halide lamps work with stabilizers for high-pressure sodium lamps/metal-halide lamps and igniters for metal-halide lamps.

Material: glass

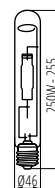

MHE-250W



MHE-400W

Kanlux





OPRAWY DOMOWE I DEKORACYJNE
DOMESTIC AND DECORATIVE FIXTURES

**Każdego dnia gościemy w Twoim domu.
Ty dbasz o to by Twoje wnętrza były piękne,
a my dbamy o to by nasze produkty
były dopracowane w każdym detalu.**

We are present in your house every day.
You take care of the beauty of your interiors,
and we take care of refining our products
down to in the finest detail.



*dane fotometryczne znajdziesz na:
photometric data you can find on:*

► kanlux.com

Kanlux AGZAR C

LAMPKA WISZĄCA ► PENDANT LAMP



AGZAR C 3xE14 B

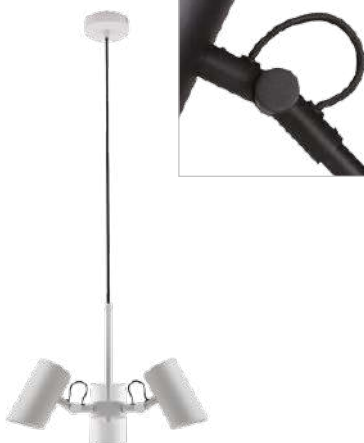

AGZAR C 3xE14 W



Kanlux AGZAR to stalowa i elegancka odsłona opraw o ciekawym i nowoczesnym wzornictwie. Niewątpliwym atutem tych opraw jest możliwość szerokiego obrotu klosza. Przewody są w materiałowym oplocie, a lampa wykonana jest z dbałością o każdy szczegół. Oprawy wiszące Kanlux AGZAR mają 3 punkty świetlne (źródła światła o trzonku E14 i maksymalnej mocy 5W) i są to oprawy klasy PREMIUM.

Materiał obudowy: stal

Kanlux AGZAR is a steel and elegant version of luminaires with an interesting and modern design. An undoubted advantage of these fittings is the ability to rotate the lampshade. The cables are braided and the lamp is made with attention to every detail. Kanlux AGZAR suspended luminaires have 3 light points (light sources with an E14 cap and a maximum power of 5W) and they are PREMIUM class luminaires.

Enclosure material: steel



AGZAR C 3xE14 B	36252	5905339362520	3 x max 5W	czarny black
AGZAR C 3xE14 W	36253	5905339362537	3 x max 5W	biały white

[V] 220-240 AC	[Hz] 50	E14	IP 20	5+25	180°
180°	3 x 1+2,5	0,5m	CE	ERL	UK

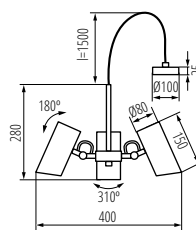

AGZAR C 3xE14

Kanlux GALOBA C

LAMPKA WISZĄCA ► PENDANT LAMP



GALOBA C 1xGU10 B



GALOBA C 3xGU10 B



GALOBA C 1xGU10 W



GALOBA C 3xGU10 W



GALOBA C 1xGU10 W	33682	5905339336828	max 35	biały white
GALOBA C 1xGU10 B	33683	5905339336835	max 35	czarny black
GALOBA C 3xGU10 W	33684	5905339336842	3 x max 35	biały white
GALOBA C 3xGU10 B	33685	5905339336859	3 x max 35	czarny black

[V] 220-240 AC	[Hz] 50	PAR16	GU10	IP 20	5+25
0,75+1,5	0,5m	CE	ERL	UK	



Kanlux GALOBA to kompletna seria opraw oświetleniowych, na którą składają się lampy wiszące (GALOBA C), kinkiety (GALOBA W) i oprawy ścienna-sufitowe. Lampy wiszące Kanlux GALOBA C z powodzeniem zastosujesz w oświetleniu wysp lub stołów, oprawy ścienna-sufitowe GALOBA (od 1 do 4 punktów świetlnych) możesz zastosować w salonie, holu czy sypialni. Dopelnieniem aranżacji staną się kinkiety GALOBA W, które mają włącznik w podstawie. Cała seria opraw Kanlux GALOBA posiada rozkręcany klosz, dzięki czemu szybko i wygodnie wymienimy źródła światła. Maksymalna wysokość źródła światła do opraw GALOBA to 55mm. Polecamy zastosowanie źródeł Kanlux SMART (S GU10) lub iQ-LED LIFE (iQ LED L GU10).

Maksymalna wysokość źródła światła 55 mm

Materiał obudowy: stop aluminium

Kanlux GALOBA is a complete series of luminaires, including pendant lamps (GALOBA C), wall lamps (GALOBA W) and wall and ceiling fixtures. Kanlux GALOBA C pendant lamps can be successfully used for the lighting of islands or tables, while wall and ceiling lamps (from 1 to 4 points of light) can be used in a living room, hall or bedroom. The arrangement can be completed with wall lamps, which have a switch in the base. All luminaires from the Kanlux GALOBA series have a detachable lampshade thanks to which the light sources can be quickly and comfortably replaced.

Maximum light-source height 55mm

Enclosure material: aluminum alloy

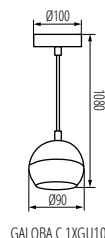

GALOBA C 1xGU10

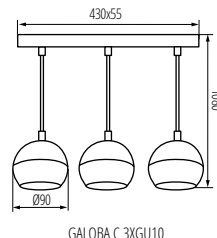

GALOBA C 3xGU10

Kanlux

JASMIN C

LAMPA WISZĄCA ► PENDANT LAMP

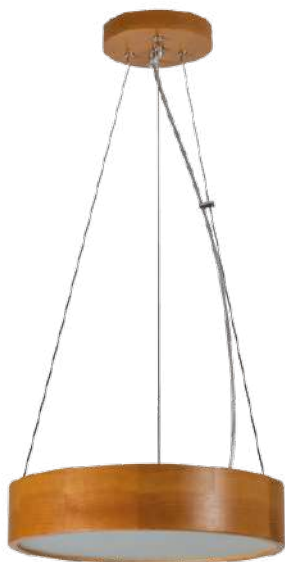

JASMIN C 470-G/O



JASMIN C 270-G/O



JASMIN C 370-G/O



Kanlux JASMIN C to rodzina drewnianych, okrągłych opraw wiszących z wymiennym źródłem światła. Dostępne są różne wielkości i kolory tych opraw wiszących, a do każdej z nich dobierzesz od 1 do 3 źródeł światła z trzonkiem E27. Lampy wiszące Kanlux JASMIN C możesz uzupełnić o kinkiety i plafonierey tej samej serii aby zachować estetykę i spójność w pomieszczeniu, czy nawet w całym domu lub obiekcie, który wyposażasz w to oświetlenie.

oprawa zawieszana na linkach stalowych

Materiał obudowy: drewno

Materiał klosza: szkło

Kanlux JASMIN C is a family of wooden, round hanging holders with a replaceable source of light. Different sizes and colours of ceiling light fixtures are available - from 1 to 3 light sources with E27 light bulb base match each of them. The holders can be enriched by wall lamps and ceiling light fixtures of the same series.

fitting suspended on steel wires

Enclosure material: Wood

Lampshade material: glass



JASMIN C 270-G/O	36499	5905339364999	max 20	E27	złoty dąb golden oak
JASMIN C 370-G/O	36500	5905339365002	2 x max 20	E27	złoty dąb golden oak
JASMIN C 470-G/O	36501	5905339365019	3 x max 20	E27	złoty dąb golden oak
JASMIN C 270-W/M	36502	5905339365026	max 20	E27	biały mat matte white
JASMIN C 370-W/M	36503	5905339365033	2 x max 20	E27	biały mat matte white
JASMIN C 470-W/M	36504	5905339365040	3 x max 20	E27	biały mat matte white
JASMIN C 270-B	36505	5905339365057	max 20	E27	czarny black
JASMIN C 370-B	36506	5905339365064	2 x max 20	E27	czarny black
JASMIN C 470-B	36507	5905339365071	3 x max 20	E27	czarny black

[V] 220-240 AC	[Hz] 50	⏚	IP 20	🏠	🌡️ 5-25	⬆️
🔌 0,5m	📏 1	🐜	CE	EAC	UK CA	♻️

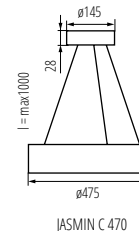
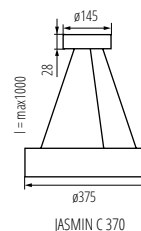
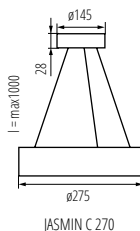

Kanlux ETISSA

LAMPKA WISZĄCA ► PENDANT LAMP



ETISSA D20 GR



ETISSA D20 GR | 27000 | 5905339270009 max 40 szary | grey

[V] 220-240 AC	[Hz] 50	E27	IP 20	House icon	Temperature icon 5+25	Light fixture icon
Box icon	Dimensions icon 0,75+2,5	Length icon 0,5m	Light bulb icon	CE	ERAC	UK CA



Kanlux ETISSA to lampy wiszące, które współpracują ze wszystkimi źródłami światła o trzonku E27. Oprawy wykonane są z masy betonopodobnej. Stylistycznie są to produkty utrzymane w surowym, loftowym klimacie, doskonale pasujące do nowoczesnych, minimalistycznych wnętrz. Ich powłoka jest porowata, co jest charakterystyczne dla powierzchni betonowych.

Materiał klosza: odlew gipsowy

Kanlux ETISSA are hanging lamps which cooperate with all sources of light with E27 light bulb base. Holders are made of concrete mass. In stylistic terms, they are products in a severe, loft-like climate, perfectly matching modern, minimalist interiors. Their coating is porous, which is characteristic of concrete surfaces.

Lampshade material: plaster cast

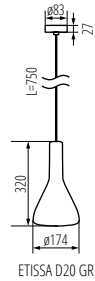

ETISSA D20 GR

Kanlux OGIVA

LAMPKA WISZĄCA ► PENDANT LAMP



OGIVA D35 GR



OGIVA D35 GR | 27001 | 5905339270016 max 40 szary | grey

[V] 220-240 AC	[Hz] 50	E27	IP 20	House icon	Temperature icon 5+25	Light fixture icon
Box icon	Dimensions icon 0,75+2,5	Length icon 0,5m	Light bulb icon	CE	ERAC	UK CA



Kanlux OGIVA to lampy wiszące, które współpracują ze wszystkimi źródłami światła o trzonku E27. Oprawy wykonane są z masy betonopodobnej w kolorze naturalnym (szarym). Stylistycznie są to produkty utrzymane w surowym, loftowym stylu, doskonale pasujące do nowoczesnych, minimalistycznych wnętrz. Ich powłoka jest porowata, co jest charakterystyczne dla powierzchni betonowych. Lampy wyprodukowane zostały w Polsce.

Materiał klosza: odlew gipsowy

Kanlux OGIVA are hanging lamps co-operating with all light sources with E27 light bulb base. Luminaires are made of concrete mass of natural colour (grey). In terms of style, the products have austere, loft style, perfectly matching modern, minimalist interiors. Their coating is porous, which is characteristic of concrete surfaces. The lamps are manufactured in Poland.

Lampshade material: plaster cast

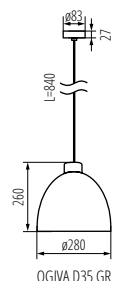

OGIVA D35 GR

Kanlux

SONOR GU10

OPRAWA SUFITOWA PUNKTOWA ► CEILING-MOUNTED SPOTLIGHT FITTING



SONOR GU10 CO-B

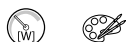

SONOR GU10 CO-B WW | **24362** | 5905339243621 max 10 czarny | black

[V] 220-240 AC	[Hz] 50	[W]/LED 4	PAR16	GU10	100	≥15000	20000	3000
glipse ≤ 6x Maxdäm	Ra 80	SMD			IP 20	5+25		
	[mm] 1,5-2,5	0,5m		CE	ERAC	UK		

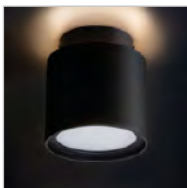
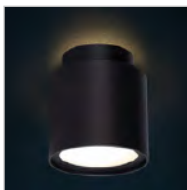

Kanlux SONOR GU10 to oprawa natynkowa z dodatkowym paskiem LED. Dzięki dwóm niezależnym źródłom światła lampa ta może świecić na trzy różne sposoby. Świeci tylko pasek LED (efekt oświetlonego sufitu, idealne rozwiązanie jako światło wieczorne), świeci tylko żarówka w oprawie (dzięki kloszowi z tworzywa oprawa wygląda jak zintegrowana), trzeci wariant to jednoczesne świecenie obu źródeł światła i pełne wykorzystanie możliwości oprawy. Dla uzyskanie najlepszego efektu zaleca się stosowanie żarówek o temperaturze barwowej 3000 K. Do obsługi lamp Kanlux SONOR polecamy stosowanie włącznika dwugrupowego (podwójnego), tak aby w pełni wykorzystać możliwości świecenia tych opraw.

Materiał obudowy: stop aluminium

Materiał klosza: tworzywo sztuczne

Kanlux SONOR GU10 is a surface-mounted luminaire with an additional LED strip. Thanks to two independent light sources, this lamp can shine in three different ways. With only the LED strip shining (ceiling effect, ideal as evening light), only the bulb in the luminaire shining (thanks to the plastic lampshade, the luminaire looks like an integrated one), while the third variant is to light both light sources simultaneously and make full use of its possibilities. For best effect, we recommend the use of light bulbs with a colour temperature of 3000 K. For Kanlux SONOR lamps, we recommend the use of a two-group (double) switch in order to take full advantage of the possibilities of lighting these lamps.

Enclosure material: aluminum alloy

Lampshade material: plastic

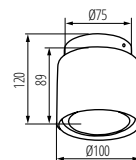

SONOR GU10 CO

Kanlux

SANI IP44

OPRAWA SUFITOWA PUNKTOWA ► CEILING-MOUNTED SPOTLIGHT FITTING



SANI IP44 DSO-B



SANI IP44 DSO-W



SANI IP44 DSO-SN

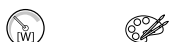

SANI IP44 DSO-B	29240	5905339292407	max 10	czarny black
SANI IP44 DSO-W	29241	5905339292414	max 10	biały white
SANI IP44 DSO-SN	29242	5905339292421	max 10	nikiel satynowy nickel satin

[V] 220-240 AC	[Hz] 50	PAR16	GU10	IP 44	5+25	
	[mm] 0,75+1,5	0,5m		CE	ERAC	UK



KANLUX SANI IP44 to oprawy natynkowe. Charakteryzują się prostą stylistyką i dostępnością w trzech kolorach: biały, czarny i satynowy nikiel. Wysoka szczelność opraw (IP44) pozwala stosować je w pomieszczeniach, w których urządzenia elektryczne narażone są na podwyższoną wilgotność oraz ryzyko zalania wodą m.in. łazienka i kuchnia.

Oprawa dla źródeł LED.

Materiał obudowy: stop aluminium

Materiał klosza: tworzywo sztuczne

KANLUX SANI IP44 are surface holders. They are characterized by simple stylistics and availability in two colours - white and black. High tightness of the holders (IP44) allows using them in rooms where electric devices are exposed to increased humidity and risk of flooding with water e.g. bathroom and kitchen.

Luminaire only for LED source.

Enclosure material: aluminum alloy

Lampshade material: plastic

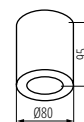

SANI IP44 DSO

AQILO IP65

OPRAWA SUFITOWA PUNKTOWA ► CEILING-MOUNTED SPOTLIGHT FITTING



AQILO IP65 DSO-W



AQILO IP65 DSO-W	33360	5905339333605	max 7	biały white
AQILO IP65 DSO-B	33361	5905339333612	max 7	czarny black
AQILO IP65 DSO-GR	33362	5905339333629	max 7	grafitowy graphite
AQILO E14 IP65 DSO-GR	36640	5905339366405	max 10	grafitowy graphite
AQILO E14 IP65 DSO-W	36641	5905339366412	max 10	biały white
AQILO E14 IP65 DSO-B	36642	5905339366429	max 10	czarny black
AQILO E27 IP65 DSO-GR	36643	5905339366436	max 20	grafitowy graphite
AQILO E27 IP65 DSO-W	36644	5905339366443	max 20	biały white
AQILO E27 IP65 DSO-B	36645	5905339366450	max 20	czarny black

[V] 220-240 AC	[Hz] 50		IP 65		 -20+35	
	 0,5m		CE	EMC	UK CA	



KANLUX AQILO to pierwsza oprawa natynkowa Kanlux o tak wysokim stopniu szczelności - IP65. Charakteryzuje się prostą stylistyką i dostępnością w trzech kolorach: białym, czarnym i grafitowym. Wysoka szczelność przeznaczona jest do pomieszczeń, w których lampy narażone są na podwyższoną wilgotność oraz ryzyko zalania wodą, m.in. łazienka i kuchnia oraz do stosowania w strefach zewnętrznych domu jak tarasy, balkony, czy zadaszone wejścia. Do lamp sam dobierzesz odpowiadające Ci źródła światła. Dodatkową zaletą lamp AQILO E14 i AQILO E27 jest odbłyśnik.

Materiał obudowy: stop aluminium

Materiał klosza: tworzywo sztuczne

KANLUX AQILO is the first Kanlux surface-mounted luminaire with such a high IP degree - IP65. It is characterized by a simple design and availability in three colors: white, black and graphite. High tightness is intended for rooms where the lamps are exposed to increased humidity and the risk of flooding with water, e.g. bathroom and kitchen, and for use in external areas of the house, such as terraces, balconies or covered entrances. You can choose the light sources that suit you. An additional advantage of AQILO E14 and AQILO E27 lamps is the reflector.

Enclosure material: aluminum alloy

Lampshade material: plastic

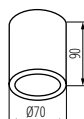

AQILO IP65 DSO

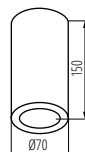

AQILO E14 IP65 DSO

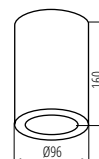

AQILO E27 IP65 DSO

Kanlux

AQILO IP65

OPRAWA SUFITOWA PUNKTOWA ▶ CEILING-MOUNTED SPOTLIGHT FITTING

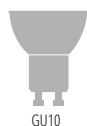

AQILO IP65 DSO-GR



AQILO IP65 DSO-W



AQILO IP65 DSO-B



AQILO E14 IP65 DSO-GR



AQILO E14 IP65 DSO-W



AQILO E14 IP65 DSO-B



AQILO E27 IP65 DSO-GR



AQILO E27 IP65 DSO-W



AQILO E27 IP65 DSO-B



Kanlux STOBI

OPRAWA SUFITOWA PUNKTOWA ► CEILING-MOUNTED SPOTLIGHT FITTING



STOBI DLP 50-B



Kanlux STOBI to linia opraw sufitowych z wymiennym źródłem światła. Wykonane są z aluminium i mają możliwość pełnej regulacji kąta padania światła. Wysokiej jakości wykończenie (powierzchnia matowa, piaskowana) i prosta stylistyka sprawiają, że oprawy doskonale nadają się do wyposażenia pomieszczeń domowych, ale również biur i apartamentów.

Materiał obudowy: stop aluminium

The Kanlux STOBI is the line of ceiling fixtures, with a replaceable light source. They are in aluminium with a fully adjustable light-beam angle. The high-quality finish (matte, sanded surface), and simple style, make the fixtures perfect for rooms at home, and also for offices and apartments.

Enclosure material: aluminum alloy



STOBI DLP 50-W



STOBI DLP 250-W

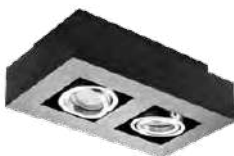

STOBI DLP 250-B



STOBI DLP 50-B	26830	5905339268303	max 10	czarny black
STOBI DLP 50-W	26831	5905339268310	max 10	biały white
STOBI DLP 250-B	26832	5905339268327	2 x max 10	czarny black
STOBI DLP 250-W	26833	5905339268334	2 x max 10	biały white

[VI] 220-240 AC	[Hz] 50	PAR16	GU10	IP 20	5+25	CE	ERL	UK CA
60/45	1+2,5	0,5m						

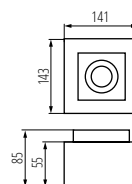

STOBI DLP 50

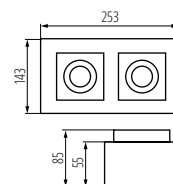

STOBI DLP 250

Kanlux RITI

OPRAWA SUFITOWA PUNKTOWA ► CEILING-MOUNTED SPOTLIGHT FITTING



RITI GU10 W/W



RITI GU10 B/B



RITI GU10 W/G



RITI GU10 B/G



RITI GU10 B/B	27567	5905339275677	max 10	czarny black
RITI GU10 W/W	27569	5905339275691	max 10	biały white
RITI GU10 W/G	27570	5905339275707	max 10	biały / złoty white / gold
RITI GU10 B/G	27571	5905339275714	max 10	czarny / złoty black/gold

[V] 220-240 AC	[Hz] 50	PAR16	GU10	⊕	IP 20	⌂	°C 5+25	⬆
	 0,75+1,5	 0,5m		CE	ERC	UK CA		

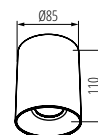

RITI GU10

Kanlux BORD

OPRAWA SUFITOWA PUNKTOWA ► CEILING-MOUNTED SPOTLIGHT FITTING



BORD DLP-50-B



BORD DLP-50-W



BORD DLP-50-W	22551	5905339225511	max 10	biały mat matte white
BORD DLP-50-B	22552	5905339225528	max 10	czarny mat black matt

[V] 220-240 AC	[Hz] 50	PAR16	GU10	⊕	IP 20	⌂	°C 5+25	⬆	
	 0,75+1,5	 0,5m		CE	ERC	UK CA			

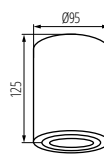

BORD DLP-50

MO
DE
RN
design

HIGH
quality
finish

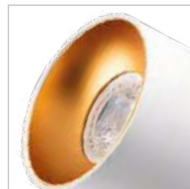
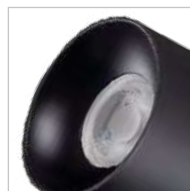
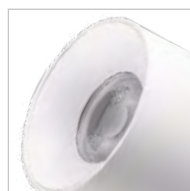

Kanlux RITI to oprawa wykonana z aluminium. Jej piaskowana struktura obudowy jest dodatkowo pokryta matowym lakierem w eleganckiej czerni lub bieli. Oprawę Kanlux RITI cechuje dobra jakość wykonania i nowoczesne wzornictwo. Z powodzeniem możemy zastosować ją jako oświetlenie samodzielne lub zestawiać ze sobą kilka opraw. Odkręcany korpus zapewnia łatwą wymianę źródła światła. Do wyboru mamy odbłyśnik: złoto-miedziany z błyszczącym pigmentem, biały lub czarny. Oprawa Kanlux RITI przystosowana jest do montażu natynkowego.

Materiał obudowy: stop aluminium

The Kanlux RITI is in aluminium, the sandblasted surface structure is matte-lacquered, and the reflector is covered with a layer of gold-copper lacquer with a shiny pigment. The Kanlux RITI series is characterised by good-quality workmanship and modern design. It can be successfully used as a stand-alone lighting system, or as a combination of several fixtures.

Enclosure material: aluminum alloy



Kanlux BORD to popularne oprawy natynkowe. Charakteryzuje je ciekawy i wyrazisty kształt w formie walca. Kanlux BORD gwarantują wyjątkowe oświetlenie umożliwiające podkreślenie niektórych elementów wystroju pomieszczenia i stworzenie przyjemnego nastroju. Nowoczesny design a także elegancka prostota sprawiają, że oprawy te pasują zarówno do wnętrz mieszkalnych jak i komercyjnych.

Materiał obudowy: stop aluminium

Kanlux BORD are popular surface holders. They are characterized by an interesting and expressive shape in the form of a cylinder. Kanlux BORD guarantee exceptional lighting making it possible to emphasize some elements of decor in a room and create pleasant atmosphere. Modern design and elegant simplicity make these holders match both residential interiors and commercial interiors.

Enclosure material: aluminum alloy

Kanlux BORD XS

OPRAWA SUFITOWA PUNKTOWA ► CEILING-MOUNTED SPOTLIGHT FITTING



BORD XS DLP-50-B



BORD XS DLP-50-W

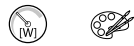

BORD XS DLP-50-B	25478	5905339254788	max 10W	czarny black
BORD XS DLP-50-W	25479	5905339254795	max 10W	biały white

[V]	[Hz]	PAR16 LED	GU10	⊕	IP	°C	⚡
220-240 AC	50	5 W	1+2,5	20	5+25		
	25		0,5m	CE	EAC	UK CA	

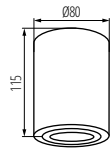

BORD XS DLP-50

Kanlux GORD XS

OPRAWA SUFITOWA PUNKTOWA ► CEILING-MOUNTED SPOTLIGHT FITTING



GORD XS DLP-50-B



GORD XS DLP-50-W



GORD XS DLP-50-B	25476	5905339254764	max 10	czarny black
GORD XS DLP-50-W	25477	5905339254771	max 10	biały white

[V]	[Hz]	PAR16 LED	GU10	⊕	IP	°C	⚡
220-240 AC	50	5 W	1+2,5	20	5+25		
	25		0,5m	CE	EAC	UK CA	

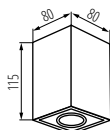

GORD XS DLP-50



Łagodne krawędzie, zakrzywione linie i opływowy kształt nadają oprawom Kanlux BORD XS elegancji i subtelności. Nowoczesny design, elegancka prostota oraz owalny kształt sprawiają, że oprawy te pasują zarówno do wnętrz mieszkalnych jak i komercyjnych. Jest to nowa odsłona popularnych opraw Kanlux BORD.

Materiał obudowy: metal

Gentle edges, curved lines and a streamlined shape give Kanlux BORD XS luminaires elegance and subtlety. Modern design, elegant simplicity and an oval shape make these luminaires fit both residential and commercial interiors. This is a new version of the popular Kanlux BORD luminaires.

Enclosure material: aluminum alloy



Kanlux GORD XS charakteryzuje się nowym, ciekawszym krojem od swojego poprzednika (Kanlux GORD). Oprawy te gwarantują wyjątkowe oświetlenie umożliwiające podkreślenie wybranych elementów wystroju pomieszczenia. Zmieniona odsłona tych popularnych opraw zadowoli miłośników geometrycznych kształtów.

Materiał obudowy: metal

Kanlux GORD XS has a new, more interesting style than its predecessor (Kanlux GORD). These luminaires provide unique lighting that allows you to emphasize selected elements of the interior design. The changed version of these popular luminaires will satisfy lovers of geometric shapes.

Enclosure material: aluminum alloy

Kanlux

BLURRO

OPRAWA SUFITOWA PUNKTOWA ► CEILING-MOUNTED SPOTLIGHT FITTING



BLURRO GU10 CO-B



BLURRO GU10 CO-W



HIGH
quality
finish

DESIGN
unique

Kanlux BLURRO to punktowe lampy sufitowe. Nietypowe wzornictwo tych opraw z powodzeniem możesz zastosować w wielu pomieszczeniach. Swobodna regulacja kierunku strumienia światła to ich dodatkowy atut. Kształt opraw Kanlux BLURRO jest pozornie prosty, ale na pewno nie jest nudny, ta lampa z dwoma punktami światła z powodzeniem oświetli pokój dzienny, kuchnię, ale także przedpokój. W większych pomieszczeniach z powodzeniem zestawisz kilka opraw.

Materiał obudowy: stop aluminium

Kanlux BLURRO are spot ceiling lamps. The unusual design of these luminaires can be successfully used in many rooms in the home. Free adjustment of the light beam direction is their additional advantage. Their shape is deceptively simple, but definitely boring. Kanlux BLURRO will successfully illuminate the living room, kitchen and hall. In larger rooms, we will successfully combine several luminaires.

Enclosure material: aluminum alloy



BLURRO 2xGU10 CO-B	32952	5905339329523	2 x max 10	czarny black
BLURRO 2xGU10 CO-W	32953	5905339329530	2 x max 10	biały white

[V] 220-240 AC	[Hz] 50	PAR16	GU10	IP 20	5+25	60
60	0,75÷1,5	0,5m	CE	ERL	UK	

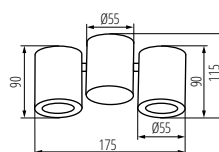

BLURRO 2XGU10 CO

Kanlux

LUMKO LED

PLAFONIERA LED ► CEILING-MOUNTED LED LIGHT FITTING

NEW



LUMKO LED 17,5W NW



LUMKO LED 17,5W NW | 37320 | 5905339373205 | 17,5 | LED | 1480 | 4000 | biały | white

[V] 220-240 AC	[Hz] 50	[°] 120	[h] ≥20000	[h] 25000	ellipse ≤ 6x MacAdam	Ra 80	Hg X	SMD
		IP 20	5+25			1,5	0,5m	
lm W 85	CE	ERC	UK CA					

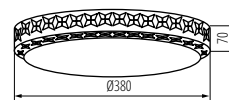

LUMKO LED 17,5W NW



Kanlux LUMKO LED to plafoniera, która jest przeznaczona dla wszystkich, którzy szukają prostej formy oprawy, ale nie chcą rezygnować z subtelnej dekoracyjności. Kanlux LUMKO LED jest w kolorze kości słoniowej, a jej dekoracyjny ring w postawie stanowi dodatkową ozdobę.

Materiał obudowy: metal

Materiał klosza: tworzywo sztuczne

Kanlux LUMKO LED is a ceiling lamp intended for everyone who is looking for a simple form of fixture, but does not want to give up subtle decorativeness. Kanlux LUMKO LED is ivory-colored, and its decorative ring in the base is an additional decoration.

Enclosure material: Metal

Lampshade material: plastic

Kanlux

CARVO LED

PLAFONIERA LED ► CEILING-MOUNTED LED LIGHT FITTING

NEW



CARVO LED 17,5W NW



CARVO LED 17,5W NW | 37321 | 5905339373212 | 17,5 | LED | 1320 | 4000 | biały | white

[V] 220-240 AC	[Hz] 50	[°] 120	[h] ≥20000	[h] 25000	ellipse ≤ 6x MacAdam	Ra 80	Hg X	SMD
		IP 20	5+25			1,5	0,5m	
lm W 75	CE	ERC	UK CA					

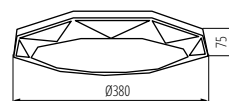

CARVO LED 17,5W NW



Kanlux CARVO LED to plafoniera, która swoim kształtem przywodzi na myśl oszlifowany diament. Eleganckie, geometryczne kształty będą pasować do nowoczesnych wnętrz, a subtelne światło plafonierki rozświetli mniejsze i średnie pomieszczenia.

Materiał obudowy: metal

Materiał klosza: tworzywo sztuczne

Kanlux CARVO LED is a ceiling lamp whose shape brings to mind a polished diamond. Elegant, geometric shapes will suit modern interiors, and the subtle light from the ceiling lamp will illuminate smaller and medium-sized rooms.

Enclosure material: Metal

Lampshade material: plastic

Kanlux

BONSA LED

PLAFONIERA LED ► CEILING-MOUNTED LED LIGHT FITTING

NEW



BONSA LED 17,5W NW



BONSA LED 17,5W NW | 37322 | 5905339373229 | 17,5 | LED | 1580 | 4000 | biały | white

[V] 220-240 AC	[Hz] 50	[°] 120	[h] ≥20000	[h] 25000	ellipse ≤ 6x160x60mm	Ra 80	Hg	SMD
		IP 20		5+25		1,5	0,5m	
lm W 90	CE	EAC	UK CA					

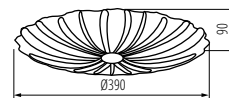

BONSA LED 17,5W NW



Plafoniera Kanlux BONSA LED to lampa, której kształt nawiązuje do materiałowego upięcia. Znajdzie uznanie wśród miłośników vintage, ale docenią ją także miłośnicy stylu angielskiego. Światło Kanlux BONSA LED ciekawie się rozkłada dzięki kształtowi i fakturze klosza.

Materiał obudowy: metal

Materiał klosza: tworzywo sztuczne

The Kanlux BONSA LED ceiling lamp is a lamp whose shape refers to a fabric updo. It will be appreciated by vintage lovers, but it will also be appreciated by lovers of the English style. The Kanlux BONSA LED light has an interesting distribution thanks to the shape and texture of the lampshade.

Enclosure material: Metal

Lampshade material: plastic

Kanlux

EXATE LED

PLAFONIERA LED ► CEILING-MOUNTED LED LIGHT FITTING

NEW



EXATE LED 17,5W NW



EXATE LED 17,5W NW | 37323 | 5905339373236 | 17,5 | LED | 1420 | 4000 | biały | white

[V] 220-240 AC	[Hz] 50	[°] 120	[h] ≥20000	[h] 25000	ellipse ≤ 6x160x60mm	Ra 80	Hg	SMD
		IP 20		5+25		1,5	0,5m	
lm W 81	CE	EAC	UK CA					

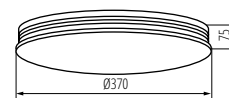

EXATE LED 17,5W NW



Plafoniera Kanlux EXATE LED to lampa o nowoczesnym kształcie. Prosty, minimalistyczny design delikatnie podkreślony jest cienkimi metalicznymi pierścieniami. Znajdzie uznanie wśród miłośników stylu nowoczesnego, a także tych, którzy cenią minimalizm.

Materiał obudowy: metal

Materiał klosza: tworzywo sztuczne

The Kanlux EXATE LED ceiling lamp is a lamp with a modern shape. The simple, minimalist design is delicately highlighted with thin metallic rings. It will find recognition among lovers of modern style, as well as those who appreciate minimalism.

Enclosure material: Metal

Lampshade material: plastic

Kanlux

SOLN LED

PLAFONIERA LED ► CEILING-MOUNTED LED LIGHT FITTING

NEW



SOLN LED 17,5W NW B/G

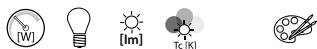

SOLN LED 17,5W NW B/G | 37324 | 5905339373243 | 17,5 | LED | 945 | 4000 | czarny / złoty | black/gold

[V] 220-240 AC	[Hz] 50	[°] 120	[h] ≥20000	[h] 25000	ellipse ≤ 6x MacAdam	Ra 80	Hg	SMD
		IP 20		°C 5+25		mm 1,5		m 0,5m
lm W 54	CE	ERC	UK CA					



Kanlux SOLN LED to oprawa oświetleniowa, która jest odzworowaniem najnowszych trendów wnętrzarskich. Ta lampa to nawiązanie do wyrafinowanego stylu art deco, który kojarzy się z luksusem, wyrazistymi fakturami oraz wykorzystaniem błyszczących powierzchni, w tym złotych dodatków. Czarno złoty, niski klosz lampy Kanlux SOLN LED nie pozostanie niezauważony we wnętrzu i stanie się jego centralną ozdobą.

Materiał obudowy: metal

Materiał klosza: tworzywo sztuczne

Kanlux SOLN LED is a lighting fixture that reflects the latest interior design trends. This lamp is a reference to the refined art deco style, which is associated with luxury, expressive textures and the use of shiny surfaces, including gold accessories. The black and gold, low shade of the Kanlux SOLN LED lamp will not go unnoticed in the interior and will become its central decoration.

Enclosure material: Metal

Lampshade material: plastic

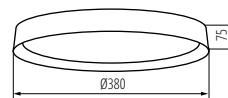

SOLN LED 17,5W NW B/G

Kanlux

AMAZI LED

PLAFONIERA LED ► CEILING-MOUNTED LED LIGHT FITTING

NEW



AMAZI LED 17,5W NW B



AMAZI LED 17,5W NW B | 37325 | 5905339373250 | 17,5 | LED | 925 | 4000 | czarny | black

[V] 220-240 AC	[Hz] 50	[°] 120	[h] ≥20000	[h] 25000	ellipse ≤ 6x MacAdam	Ra 80	Hg	SMD
		IP 20		°C 5+25		mm 1,5		m 0,5m
lm W 53	CE	ERC	UK CA					



Kanlux AMAZI LED to lampa, której wzornictwo wybiega w przyszłość i oczarowuje. Biała lampa i geometryczne czarne wzory są bardzo wyraziste i nie tolerują niedomówień. Kanlux AMAZI LED bawi się geometrią, gra mocną kreską i niesie ze sobą ładunek energii.

Materiał obudowy: metal

Materiał klosza: tworzywo sztuczne

Kanlux AMAZI LED is a lamp whose design is forward-looking and enchanting. The white lamp and geometric black patterns are very expressive and do not tolerate any understatements. Kanlux AMAZI LED plays with geometry, plays with strong lines and carries a charge of energy.

Enclosure material: Metal

Lampshade material: plastic

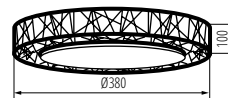

AMAZI LED 17,5W NW B

Kanlux

VAND LED

PLAFONIERA LED ► CEILING-MOUNTED LED LIGHT FITTING

NEW



VAND LED 17,5W NW W



VAND LED 17,5W NW B



Kanlux VAND LED to nowoczesna wersja tradycyjnej plafonier. Czarne lub białe elementy (zależnie o wyborze modelu) dodają jej elegancji i powiewu świeżości. Kanlux VAND LED daje bardzo subtelne światło, zatem w większych pomieszczeniach możesz użyć kilku tych lamp lub umieścić ją tylko w tych miejscach, gdzie nie potrzebujesz mocnego oświetlenia.

Materiał obudowy: metal

Materiał klosza: tworzywo sztuczne

Kanlux VAND LED is a modern version of the traditional ceiling lamp. Black or white elements (depending on the model chosen) add elegance and a breath of freshness. Kanlux VAND LED gives very subtle light, so in larger rooms you can use several of these lamps or place it only in places where you do not need strong lighting.

Enclosure material: Metal

Lampshade material: plastic



VAND LED 17,5W NW W	37326	5905339373267	17,5	LED	460	4000	biały white
VAND LED 17,5W NW B	37327	5905339373274	17,5	LED	460	4000	czarny black

[V]	[Hz]	[°]	[h]	[h]	[lm]	[Ra]	[Hg]
220-240 AC	50	120	≥20000	25000	≤60 MacAdam	80	
SMD			IP 20		5+25		
1,5	0,5m	lm W 26	CE	EAR	UK CA		

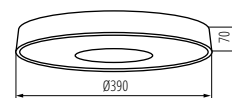

VAND LED 17,5W

RIFA LED

PLAFONIERA LED ► CEILING-MOUNTED LED LIGHT FITTING



RIFA LED 17,5W GR/G



Kanlux RIFA LED to wyjątkowa plafoniera. Od tradycyjnych lamp tego typu odróżnia ją materiałowy klosz, który czyni z niej oświetlenie nie tylko praktyczne, ale przede wszystkim dekoracyjne. Dostępne są 4 mixy kolorystyczne jak również jednolite klosze lamp. Z powodzeniem dopasujesz je do swojego wnętrza niezależnie od jego stylu. Do tego, do wyboru są dwie barwy światła – neutralna lub ciepła. Kanlux RIFA LED to idealne rozwiązanie do wnętrza, w których potrzebujemy mocnego światła, ale nie chcemy rezygnować z jego dekoracyjności.

Materiał obudowy: metal

Materiał klosza: tworzywo sztuczne

Kanlux RIFA LED is a unique ceiling lamp. It is distinguished from traditional lamps of this type by a material lampshade, which makes it not only practical, but above all decorative. We have prepared 4 color combinations to match your interior, and you have a choice of two light colors - neutral or warm. Kanlux RIFA LED is an ideal solution for low ceiling interiors where we need strong light, but we do not want to give up its decorativeness.

Enclosure material: Metal

Lampshade material: plastic

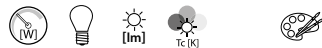

RIFA LED 17,5W NW/W/W	36460	5905339364609	17,5	LED	1500	4000	biały white
RIFA LED 17,5W WW/W/W	36461	5905339364616	17,5	LED	1450	3000	biały white
RIFA LED 17,5W NW B/W	36462	5905339364623	17,5	LED	1500	4000	czarny / biały black/white
RIFA LED 17,5W WW B/W	36463	5905339364630	17,5	LED	1450	3000	czarny / biały black/white
RIFA LED 17,5W NW B/G	36464	5905339364647	17,5	LED	1500	4000	czarny / złoty black/gold
RIFA LED 17,5W WW B/G	36465	5905339364654	17,5	LED	1450	3000	czarny / złoty black/gold
RIFA LED 17,5W NW GR/G	36466	5905339364661	17,5	LED	1500	4000	szary / złoty grey / gold
RIFA LED 17,5W WW GR/G	36467	5905339364678	17,5	LED	1450	3000	szary / złoty grey / gold
RIFA LED 17,5W NW N1	36468	5905339364685	17,5	LED	1500	4000	biały white
RIFA LED 17,5W WW N1	36469	5905339364692	17,5	LED	1450	3000	biały white
RIFA LED 17,5W NW N2	36508	5905339365088	17,5	LED	1500	4000	brązowy brown
RIFA LED 17,5W WW N2	36509	5905339365095	17,5	LED	1450	3000	brązowy brown

[V] 220-240 AC	[Hz] 50	[°] 120	[h] ≥20000	[h] 25000	[lm] ≤ 6x MacAdam	Ra 80	Hg 0,5mm	SMD
[IP] IP 20	[°C] 5+25	[mm] 1,5	[m] 0,5m	[m] 0,5m	[m] 0,5m	[m] 0,5m	[m] 0,5m	[m] 0,5m
CE	ERC	UK CA						

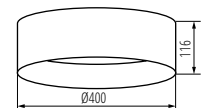

RIFA LED 17,5W

Kanlux

RIFA LED

PLAFONIERA LED ► CEILING-MOUNTED LED LIGHT FITTING



RIFA LED 17,5W W/W



RIFA LED 17,5W B/W



RIFA LED 17,5W B/G



RIFA LED 17,5W GR/G



RIFA LED 17,5W N1



RIFA LED 17,5W N2



Kanlux

ARVOS LED

PLAFONIERA LED ► CEILING-MOUNTED LED LIGHT FITTING

NEW



ARVOS LED 37W CCT B



ARVOS LED 37W CCT W



Kanlux ARVOS LED to plafoniera, która pomoże Ci zmieniać nastrój w pomieszczeniu bez konieczności zmiany lampy. Dzięki sterowaniu pilotem bezproblemowo zmienisz barwę światła i jego natężenie, a wieczorem ustawisz tryb nocny, aby ułatwić sobie odpoczynek. Kanlux ARVOS LED to lampa, dzięki której dopasujesz światło w każdym pomieszczeniu do każdej sytuacji i do wykonywanej aktualnie czynności.

Materiał obudowy: stal
Materiał klosza: PMMA

Kanlux ARVOS LED is a ceiling lamp that will help you change the mood in the room without having to change the lamp. Thanks to the remote control, you can easily change the light color and intensity, and in the evening you can set the night mode to make it easier to rest. Kanlux ARVOS LED is a lamp that allows you to adjust the light in every room to every situation and activity you are currently performing.

Enclosure material: steel
Lampshade material: PMMA

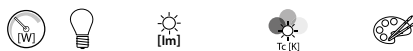

ARVOS LED 37W CCT B	37330	5905339373304	max 37	LED	max 2680 (4000K)	2700/4000/6500	czarny black
ARVOS LED 37W CCT W	37331	5905339373311	max 37	LED	max 2680 (4000K)	2700/4000/6500	biały white

[V]	[Hz]	[°]	[lm]	[h]	[lm]	[Ra]
220-240 AC	50	120	≥15000	25000	≤6/Machdam	80
Hg	SMD	IP 20	0,5m	infrared		
		DIMMING function				

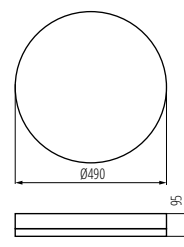

ARVOS

Kanlux

JASMIN W

OPRAWA ŚCIENNA ► WALL-MOUNTED LIGHT FITTING



JASMIN G/O-W



JASMIN WE-W



JASMIN W-W



JASMIN W/M-W



JASMIN B-W



JASMIN WE-W	23756	5905339237569	max 20	E27	LED	wenge
JASMIN W-W	23757	5905339237576	max 20	E27	LED	biały dąb white oak
JASMIN W/M-W	23758	5905339237583	max 20	E27	LED	biały white
JASMIN B-W	29209	5905339292094	max 20	E27	LED	czarny black
JASMIN G/O-W	36443	5905339364432	max 20	E27	LED	złoty dąb golden oak

[V] 220-240 AC	[Hz] 50				IP 20		5+25	
	1+1,5		0,5m					



Kinkiety Kanlux JASMIN to starannie wykonane, drewniane oprawy, które dają możliwość ciekawej aranżacji pomieszczeń. Efektowna obudowa w połączeniu z satynowym szkłem, które zapewnia równomierne rozproszenie światła, nada niepowtarzalnego charakteru każdemu wnętrzu.

Materiał obudowy: drewno

Materiał klosza: szkło

The Kanlux JASMIN wall lamps are carefully made, wooden holders which enable an arrangement of rooms in an interesting manner. The effective casing combined with satin glass which ensures even dispersal of light will give a unique character to each interior.

Enclosure material: Wood

Lampshade material: glass

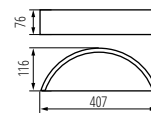

JASMIN



JASMIN 270-G/O



JASMIN 270-WE	23120	5905339231208	max 20	E27	LED	wenge
JASMIN 370-WE	23121	5905339231215	2 x max 20	E27	LED	wenge
JASMIN 470-WE	23122	5905339231222	3 x max 20	E27	LED	wenge
JASMIN 270-W	23123	5905339231239	max 20	E27	LED	dąb sonoma sonoma oak
JASMIN 370-W	23124	5905339231246	2 x max 20	E27	LED	dąb sonoma sonoma oak
JASMIN 470-W	23125	5905339231253	3 x max 20	E27	LED	dąb sonoma sonoma oak
JASMIN 270-W/M	23126	5905339231260	max 20	E27	LED	biały mat matte white
JASMIN 370-W/M	23127	5905339231277	2 x max 20	E27	LED	biały mat matte white
JASMIN 470-W/M	23128	5905339231284	3 x max 20	E27	LED	biały mat matte white
JASMIN 470-B	29205	5905339292056	3 x max 20	E27	LED	czarny black
JASMIN 270-B	29207	5905339292070	max 20	E27	LED	czarny black
JASMIN 370-B	29208	5905339292087	2 x max 20	E27	LED	czarny black
JASMIN 270-G/O	36440	5905339364401	max 20	E27	LED	złoty dąb golden oak
JASMIN 370-G/O	36441	5905339364418	2 x max 20	E27	LED	złoty dąb golden oak
JASMIN 470-G/O	36442	5905339364425	3 x max 20	E27	LED	złoty dąb golden oak



Oryginalne, a zarazem stylowe okrągłe oprawy Kanlux JASMIN cechują się nowoczesnym i atrakcyjnym designem. Obudowa plafonierzy wykonana jest z drewna oraz szkła trawionego (satynowego), które zapewnia równomierne rozproszenie światła. Klasyczne połączenie drewna i szkła sprawia, że jest to bardzo uniwersalne rozwiązanie oświetleniowe.

Materiał obudowy: drewno
Materiał klosza: szkło

The original and at the same time stylish round holders - Kanlux JASMIN are characterized by modern and attractive design. The casing of the ceiling light fixture is made of wood and etched (satin) glass which ensures even dispersal of light. The classic combination of wood and glass makes it a very universal lighting solution.

Enclosure material: Wood
Lampshade material: glass

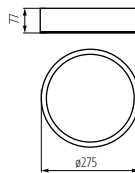

JASMIN 270

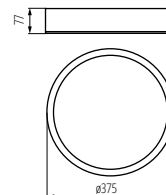

JASMIN 370

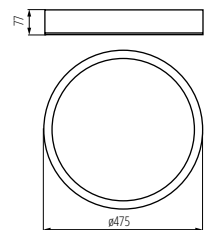

JASMIN 470

Kanlux
JASMIN

PLAFONIERA ► CEILING LIGHT FITTING



JASMIN 270-G/O



JASMIN 370-G/O



JASMIN 470-G/O



JASMIN 270-WE



JASMIN 370-WE



JASMIN 470-WE



JASMIN 270-W



JASMIN 370-W



JASMIN 470-W



JASMIN 270-W/M



JASMIN 370-W/M



JASMIN 470-W/M



JASMIN 270-B



JASMIN 370-B



JASMIN 470-B



DERATO EL-10 B-SR



Seria opraw Kanlux DERATO kształtem nawiązuje do stylistyki RETRO. To lampy w dwóch kolorach: białym i czarnym, które posiadają od 1 do 4 punktów świetlnych. Jednopunktowe Kanlux DERATO z powodzeniem spełni również rolę kinkietu. Duże klosze tych opraw to także duże możliwości w zastosowaniu różnych źródeł światła z trzonkiem E14 (max.8W). W oprawach Kanlux DERATO zastosowano szybkozłączkę dla wygodnego i szybkiego montażu. Dodatkowym atutem jest bardzo szeroka możliwość skierowania klosza w dowolne miejsce (dwie osie obrotu 350 i 110 stopni).

Materiał obudowy: stop aluminium

The new series of Kanlux DERATO luminaires is reminiscent of the RETRO style. These are luminaires in two colors: white and black, which have from 1 to 4 light points. Kanlux DERATO single-point lamps will also successfully fulfill the role of a wall lamp. Large lampshades of these luminaires also offer great possibilities for the use of various light sources with an E14 cap (max 8W). Kanlux DERATO luminaires use a quick mount terminals for convenient and quick installation. An additional advantage is the very wide possibility of directing the lampshade to any place (two rotation axes: 350 and 110 degrees).

Enclosure material: aluminum alloy



DERATO EL-10 B-SR	35640	5905339356406	max 8	czarny / srebrny black / silver
DERATO EL-10 W-SR	35641	5905339356413	max 8	biały / srebrny white / silver
DERATO EL-21 B-SR	35642	5905339356420	2x max 8	czarny / srebrny black / silver
DERATO EL-21 W-SR	35643	5905339356437	2x max 8	biały / srebrny white / silver
DERATO EL-30 B-SR	35644	5905339356444	3x max 8	czarny / srebrny black / silver
DERATO EL-30 W-SR	35645	5905339356451	3x max 8	biały / srebrny white / silver
DERATO EL-41 B-SR	35646	5905339356468	4x max 8	czarny / srebrny black / silver
DERATO EL-41 W-SR	35647	5905339356475	4x max 8	biały / srebrny white / silver

[V] 220-240 AC	[Hz] 50				IP 20		 5+25	
 350	 110		 0,5m	CE	EAC	UK		

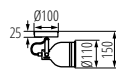

DERATO EL-10

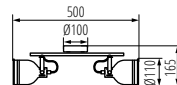

DERATO EL-21

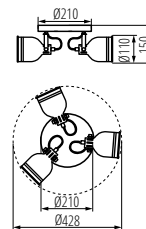

DERATO EL-30

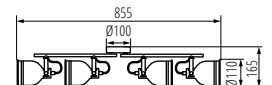

DERATO EL-41

Kanlux

DERATO

OPRAWA ŚCIENNO-SUFITOWA ► WALL & CEILING LIGHTING FITTING



DERATO EL-10 B-SR



DERATO EL-10 W-SR



DERATO EL-21 B-SR



DERATO EL-21 W-SR



DERATO EL-30 B-SR



DERATO EL-30 W-SR



DERATO EL-41 B-SR



DERATO EL-41 W-SR



Kanlux EVALO

OPRAWA ŚCIENNO-SUFITOWA ► WALL & CEILING LIGHTING FITTING



EVALO EL-11 B-SR



EVALO EL-5I W-SR	35688	5905339356888	5 x max 10	biały white
EVALO EL-5I B-SR	35689	5905339356895	5 x max 10	czarny black
EVALO EL-1I W-SR	35690	5905339356901	max 10	biały white
EVALO EL-1I B-SR	35691	5905339356918	max 10	czarny black
EVALO EL-2I W-SR	35692	5905339356925	2 x max 10	biały white
EVALO EL-2I B-SR	35693	5905339356932	2 x max 10	czarny black
EVALO EL-3I W-SR	35694	5905339356949	3 x max 10	biały white
EVALO EL-3I B-SR	35695	5905339356956	3 x max 10	czarny black
EVALO EL-4I W-SR	35696	5905339356963	4 x max 10	biały white
EVALO EL-4I B-SR	35697	5905339356970	4 x max 10	czarny black
EVALO EL-4I W-SR	35698	5905339356987	4 x max 10	biały white
EVALO EL-4I B-SR	35699	5905339356994	4 x max 10	czarny black

[V] 220-240 AC	[Hz] 50		PAR16	GU10		IP 20	
 5+25	 320	 90	 1+2,5	 0,5m			

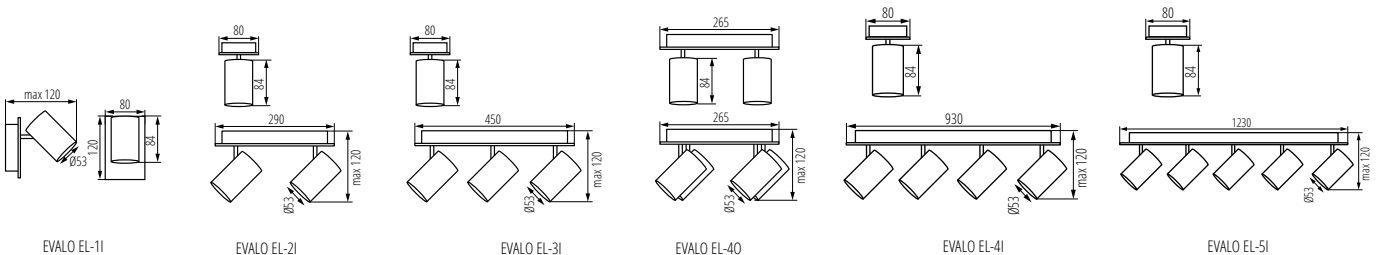

Kanlux EVALO to rodzina prostych spotów. Skandynawska wręcz prostota i srebrne elementy to wysoce elegancka klasyka. Wąski klosz mieści w sobie źródła GU10 (w komplecie dodajemy przysawkę, która ułatwia ich montaż). Dwa kolory (czarny i biały) oraz ilość od 1 do 5 punktów świetlnych tych opraw otwiera wiele możliwości aranżacji. Spot Kanlux EVALO z 1 punktem to idealny kinkiet nad biurko, łóżko czy za kanapę. Dzięki takiej aranżacji Kanlux EVALO może pełnić rolę światła głównego i dodatkowego. Dodatkowym atutem jest możliwość dużej regulacji kierunku padania światła (dwie osie obrotu: 320 i 90 stopni).

Materiał obudowy: stop aluminium

Kanlux EVALO is a family of simple spots. Scandinavian simplicity and silver elements are a highly elegant classic. The narrow shade accommodates GU10 sources (we add a suction cup in the set, which facilitates their installation). Two colors (black and white) and the number of 1 to 5 light points of these luminaires open many arrangement possibilities. The Kanlux EVALO spotlight with 1 point is a perfect wall lamp above the desk, bed or behind the sofa. Thanks to this arrangement, Kanlux EVALO can act as the main and additional light. An additional advantage is the ability to adjust the direction of light incidence (two axes of rotation: 320 and 90 degrees).

Enclosure material: aluminum alloy

Kanlux

EVALO

OPRAWA ŚCIENNO-SUFITOWA ► WALL & CEILING LIGHTING FITTING



EVALO EL-11 W-SR



EVALO EL-21 B-SR



EVALO EL-21 W-SR



EVALO EL-31 B-SR



EVALO EL-31 W-SR



EVALO EL-40 B-SR



EVALO EL-40 W-SR



EVALO EL-41 B-SR



EVALO EL-41 W-SR



EVALO EL-51 B-SR



EVALO EL-51 W-SR



SONDA II

OPRAWA ŚCIENNO-SUFITOWA ► WALL & CEILING LIGHTING FITTING



SONDA II EL-10 B



SONDA II EL-10 B	34920	5905339349200	max 10	czarny black
SONDA II EL-10 W	34921	5905339349217	max 10	biały white
SONDA II EL-21 B	34922	5905339349224	2 x max 10	czarny black
SONDA II EL-21 W	34923	5905339349231	2 x max 10	biały white
SONDA II EL-31 B	34924	5905339349248	3 x max 10	czarny black
SONDA II EL-31 W	34925	5905339349255	3 x max 10	biały white
SONDA II EL-30 B	34926	5905339349262	3 x max 10	czarny black
SONDA II EL-30 W	34927	5905339349279	3 x max 10	biały white
SONDA II EL-40 B	34928	5905339349286	4 x max 10	czarny black
SONDA II EL-40 W	34929	5905339349293	4 x max 10	biały white

[V] 220-240 AC	[Hz] 50				IP 20	
5+25	330	120	1+2,5	0,5m		

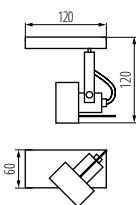

SONDA II EL-10

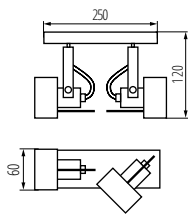

SONDA II EL-21

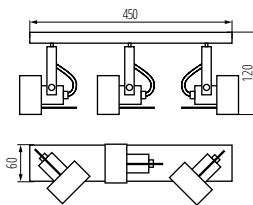

SONDA II EL-31

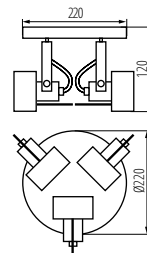

SONDA II EL-30

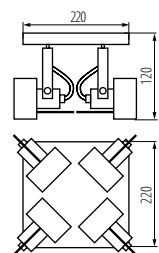

SONDA II EL-40



Kanlux SONDA II to nowoczesna seria lamp, w której możesz wybrać od 1 do 4 punktów świetlnych. Nowoczesny kształt tych opraw stanie się niepowtarzalną ozdobą każdego wnętrza. Dodatkowym atutem lamp Kanlux SONDA II jest wyjątkowo eleganckie wykonanie klosza, które ukrywa brzegi źródła światła, dzięki czemu widoczna jest sama soczewka żarówki.

Materiał obudowy: stop aluminium

Kanlux SONDA II is a modern lamp series in which you can choose from 1 to 4 points of light. The modern shape of these luminaires will constitute a unique decoration of any interior. An additional advantage of Kanlux SONDA II lamps is the extremely elegant finish of the lampshade that hides the edges of the source of light so that only the bulb lens is visible.

Enclosure material: aluminum alloy

Kanlux

SONDA II

OPRAWA ŚCIENNO-SUFITOWA ► WALL & CEILING LIGHTING FITTING



SONDA II EL-10 W



SONDA II EL-21 B



SONDA II EL-21 W



SONDA II EL-31 B



SONDA II EL-31 W



SONDA II EL-30 B



SONDA II EL-30 W



SONDA II EL-40 B



SONDA II EL-40 W





GALOBA EL-10 W



GALOBA EL-10 W	33670	5905339336705	max 35	biały white
GALOBA EL-10 B	33671	5905339336712	max 35	czarny black
GALOBA EL-2I W	33674	5905339336743	2 x max 35	biały white
GALOBA EL-2I B	33675	5905339336750	2 x max 35	czarny black
GALOBA EL-3I W	33676	5905339336767	3 x max 35	biały white
GALOBA EL-3I B	33677	5905339336774	3 x max 35	czarny black
GALOBA EL-4I W	33678	5905339336781	4 x max 35	biały white
GALOBA EL-4I B	33679	5905339336798	4 x max 35	czarny black
GALOBA EL-4I W	33680	5905339336804	4 x max 35	biały white
GALOBA EL-4I B	33681	5905339336811	4 x max 35	czarny black

[V] 220-240 AC	[Hz] 50							
5+25	335	315	0,75+1,5	0,5m				

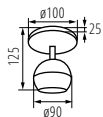

GALOBA EL-10

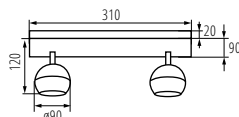

GALOBA EL-2I

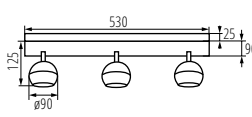

GALOBA EL-3I

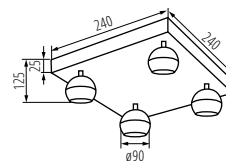

GALOBA EL-4I

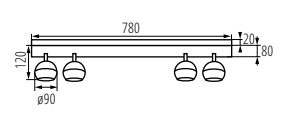

GALOBA EL-4I



Kanlux GALOBA to kompletna seria opraw oświetleniowych, na którą składają się lampy wiszące (GALOBA C), kinkiety (GALOBA W) i oprawy ściennie-sufitowe. Lampy wiszące Kanlux GALOBA C z powodzeniem zastosujesz w oświetleniu wysp lub stołów, oprawy ściennie-sufitowe GALOBA (od 1 do 4 punktów świetlnych) możesz zastosować w salonie, holu czy sypialni. Dopelnieniem aranżacji staną się kinkiety GALOBA W, które mają wyłącznik w podstawie. Cała seria opraw Kanlux GALOBA posiada rozkręcany kłoz, dzięki czemu szybko i wygodnie wymienimy źródła światła. Maksymalna wysokość źródła światła do opraw GALOBA to 55mm. Polecamy zastosowanie źródeł Kanlux SMART (S GU10) lub IQ-LED LIFE (IQ LED L GU10).

Maksymalna wysokość źródła światła 55 mm

Materiał obudowy: stop aluminium

Kanlux GALOBA is a complete series of luminaires, including pendant lamps (GALOBA C), wall lamps (GALOBA W) and wall and ceiling fixtures. Kanlux GALOBA C pendant lamps can be successfully used for the lighting of islands or tables, while wall and ceiling lamps (from 1 to 4 points of light) can be used in a living room, hall or bedroom. The arrangement can be completed with wall lamps, which have a switch in the base. All luminaires from the Kanlux GALOBA series have a detachable lampshade thanks to which the light sources can be quickly and comfortably replaced.

Maximum light-source height 55mm

Enclosure material: aluminum alloy

Kanlux

GALOBA

OPRAWA ŚCIENNO-SUFITOWA ► WALL & CEILING LIGHTING FITTING



GALOBA EL-10 B



GALOBA EL-21 W



GALOBA EL-21 B



GALOBA EL-31 W



GALOBA EL-31 B



GALOBA EL-40 W



GALOBA EL-40 B



GALOBA EL-41 W



GALOBA EL-41 B



LAURIN

OPRAWA ŚCIENNO-SUFITOWA ► WALL & CEILING LIGHTING FITTING



LAURIN EL-10 B



LAURIN EL-10 W	29120	5905339291202	max 35	biały white
LAURIN EL-10 B	29121	5905339291219	max 35	czarny black
LAURIN EL-21 W	29122	5905339291226	2 x max 35	biały white
LAURIN EL-21 B	29123	5905339291233	2 x max 35	czarny black
LAURIN EL-31 W	29124	5905339291240	3 x max 35	biały white
LAURIN EL-31 B	29125	5905339291257	3 x max 35	czarny black
LAURIN EL-30 W	29126	5905339291264	3 x max 35	biały white
LAURIN EL-30 B	29127	5905339291271	3 x max 35	czarny black
LAURIN EL-40 W	29128	5905339291288	4 x max 35	biały white
LAURIN EL-40 B	29129	5905339291295	4 x max 35	czarny black

[V] 220-240 AC	[Hz] 50					IP 20	
5+25	310	90	1+2,5	0,5m			

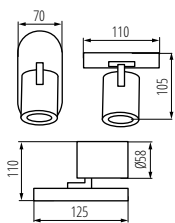

LAURIN EL-10

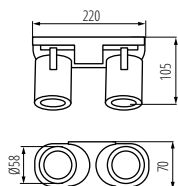

LAURIN EL-21

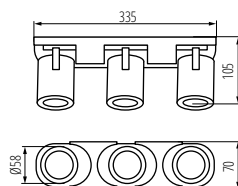

LAURIN EL-31

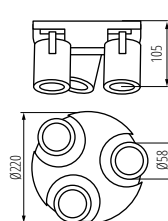

LAURIN EL-30

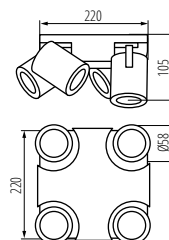

LAURIN EL-40



Spoty Kanlux LAURIN to bardzo duży wybór kierunkowych lamp sufitowo-ściennych. Proste i minimalistyczne wzornictwo z powodzeniem możecie zastosować w wielu pomieszczeniach w domu. Swobodna regulacja kierunku strumienia światła to dodatkowy atut tych opraw.

Materiał obudowy: stop aluminium

Kanlux LAURIN spotlights provide a very large selection of directional ceiling and wall lamps. The simple and minimalist design can be successfully used in many rooms in the house. Free adjustment of the luminous flux direction is an additional advantage of these fixtures.

Enclosure material: aluminum alloy

Kanlux

LAURIN

OPRAWA ŚCIENNO-SUFITOWA ► WALL & CEILING LIGHTING FITTING



LAURIN EL-10 W



LAURIN EL-21 W



LAURIN EL-21 B



LAURIN EL-31 W



LAURIN EL-31 B

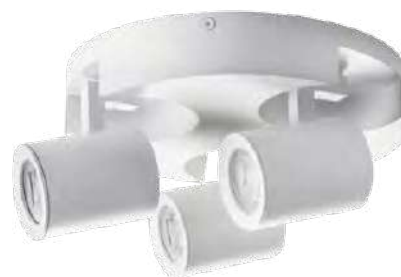

LAURIN EL-30 W



LAURIN EL-30 B



LAURIN EL-40 W



LAURIN EL-40 B



Kanlux

SEMPRA

OPRAWA ŚCIENNO-SUFITOWA ► WALL & CEILING LIGHTING FITTING



SEMPPRA EL-11 W-SR



SEMPPRA EL-21 W-SR



SEMPPRA EL-21 B-SR



SEMPPRA EL-31 W-SR



SEMPPRA EL-31 B-SR



SEMPPRA EL-41 W-SR



SEMPPRA EL-41 B-SR





ENALI EL-10 W



ENALI EL-10 W	28760	5905339287601	max 10	biały white
ENALI EL-10 B	28761	5905339287618	max 10	czarny black
ENALI EL-21 W	28762	5905339287625	2 x max 10	biały white
ENALI EL-21 B	28763	5905339287632	2 x max 10	czarny black
ENALI EL-30 W	28764	5905339287649	3 x max 10	biały white
ENALI EL-30 B	28765	5905339287656	3 x max 10	czarny black
ENALI EL-31 W	28766	5905339287663	3 x max 10	biały white
ENALI EL-31 B	28767	5905339287670	3 x max 10	czarny black
ENALI EL-41 W	28768	5905339287687	4 x max 10	biały white
ENALI EL-41 B	28769	5905339287694	4 x max 10	czarny black

[V] 220-240 AC	[Hz] 50					
5+25	310	90	1+2,5	0,5m		

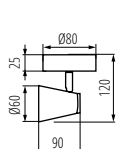

ENALI EL-10

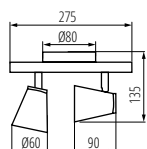

ENALI EL-21

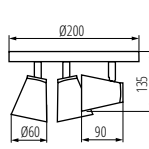

ENALI EL-30

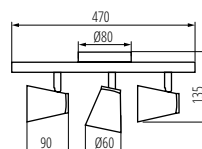

ENALI EL-31

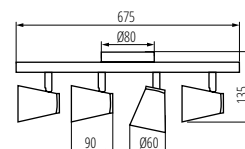

ENALI EL-41



Kanlux ENALI to rodzina opraw punktowych (sufitowo ściennych). Dzięki regulowanym przegubom możemy swobodnie ustawić kąt padania światła. Oprawy idealnie pasują do wnętrz w stylu skandynawskim, ich kształt podkreśli charakter wnętrz retro, a chromowane dodatki dodadzą subtelnego szlfu wnętrzom nowoczesnym.

Materiał obudowy: stal

Materiał klosza: stal

The Kanlux ENALI is a family of point fixtures (ceiling and wall). Thanks to the adjustable joints you can freely set the light-beam angle. The fixtures fit perfectly into Scandinavian style interiors, their shape will emphasise the character of retro interiors, and the chrome accessories will add a subtle touch to modern interiors.

Enclosure material: steel

Lampshade material: steel

Kanlux

ENALI

OPRAWA ŚCIENNO-SUFITOWA ► WALL & CEILING LIGHTING FITTING



ENALI EL-10 B



ENALI EL-21 W



ENALI EL-21 B



ENALI EL-30 W



ENALI EL-30 B



ENALI EL-31 W



ENALI EL-31 B



ENALI EL-41 W



ENALI EL-41 B





MILENO EL-10 B-AG



MILENO EL-10 B-AG	29110	5905339291103	max 10	czarny / złoty black/gold
MILENO EL-10 ASR-AN	29111	5905339291110	max 10	srebrny / miedziany silver / copper
MILENO EL-30 B-AG	29112	5905339291127	3 x max 10	czarny / złoty black/gold
MILENO EL-30 ASR-AN	29113	5905339291134	3 x max 10	srebrny / miedziany silver / copper
MILENO EL-2I B-AG	29114	5905339291141	2 x max 10	czarny / złoty black/gold
MILENO EL-2I ASR-AN	29115	5905339291158	2 x max 10	srebrny / miedziany silver / copper
MILENO EL-3I B-AG	29116	5905339291165	3 x max 10	czarny / złoty black/gold
MILENO EL-3I ASR-AN	29117	5905339291172	3 x max 10	srebrny / miedziany silver / copper
MILENO EL-4I B-AG	29118	5905339291189	4 x max 10	czarny / złoty black/gold
MILENO EL-4I ASR-AN	29119	5905339291196	4 x max 10	srebrny / miedziany silver / copper

[V] 220-240 AC	[Hz] 50					
 5=25	 300	 80	 1+2,5	 0,5m		

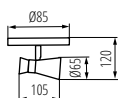

MILENO EL-10

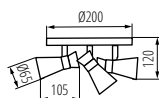

MILENO EL-30

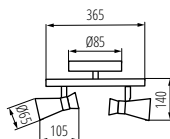

MILENO EL-2I

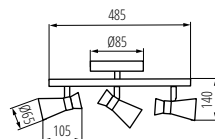

MILENO EL-3I

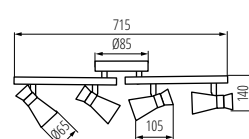

MILENO EL-4I



Kanlux MILENO to odpowiedź na najnowsze trendy. Ciekawe wzornictwo i niebanalny kształt to atuty tej serii. Bardzo duża liczba modeli opraw Kanlux MILENO to dużo większe możliwości aranżacyjne.

Materiał obudowy: stal

Kanlux MILENO follows the latest trends. The advantages of this series are its interesting design and original shape. The very-large number of Kanlux MILENO fixture models means many more arrangement possibilities.

Enclosure material: steel

Kanlux

MILENO

OPRAWA ŚCIENNO-SUFITOWA ► WALL & CEILING LIGHTING FITTING



MILENO EL-10 ASR-AN



MILENO EL-21 B-AG



MILENO EL-21 ASR-AN



MILENO EL-30 B-AG



MILENO EL-30 ASR-AN



MILENO EL-31 B-AG



MILENO EL-31 ASR-AN



MILENO EL-41 B-AG



MILENO EL-41 ASR-AN



Kanlux

BOLA LED

LAMPKA WTYKOWA LED ► LED PLUG-IN LAMP

NEW



BOLA LED 2xUSB WW W



BOLA LED 2xUSB WW W | 37397 | 5905339373977 | max 15 | 4 (0,22W) | 3000 | biały | white

[V] 220-240 AC	[Hz] 50	15000	ellipso ≤ 6x MacAdam	Hg	SMD		
IP 20			CE	ERAC	UK CA		



Kanlux BOLA LED to lampka wtykowa LED z dwoma portami USB (A i C). Lampka może działać w jednym z trzech trybów - ON - stałe włączenia/OFF - stałe wyłączenie/AUTO - włącza się przy niskim natężeniu światła (lampka posiada czujnik zmierzchu). Dzięki portom USB, lampka może też pełnić funkcje ładowarki do urządzeń mobilnych. Kanlux BOLA emituje łagodne światło nocne (4 lumeny) w ciepłobiałej temperaturze.

Materiał obudowy: PC

Materiał klosza: PC

Kanlux BOLA LED is a plug-in LED lamp with two USB ports (A and C). The lamp can operate in one of three modes - ON - permanently on/OFF - permanently off/AUTO - turns on at low light intensity (the lamp has a twilight sensor). Thanks to the USB ports, the lamp can also function as a charger for mobile devices. Kanlux BOLA emits gentle night light (4 lumens) at a warm white temperature.

Enclosure material: PC

Lampshade material: PC

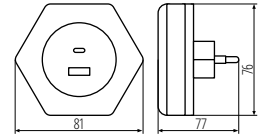

BOLA LED 2xUSB WW W

Kanlux

ULOV LED

LAMPKA WTYKOWA LED ► LED PLUG-IN LAMP

NEW



UL OV LED DIM WW W



UL OV LED DIM WW W | 37396 | 5905339373960 | 0,5 | 1-30 | 3000 | biały | white

[V] 220-240 AC	[Hz] 50	ellipso ≤ 6x MacAdam	Hg	SMD			
IP 20			CE	ERAC	UK CA		



Kanlux UL OV LED to lampka wtykowa, w której płynnie można regulować natężenie światła. Posiada wbudowany czujnik zmierzchu (automatycznie włącza-wyłącza światło). Jej przyjazny design sprawia, że możemy umieścić ją w gniazdkach sypialni, pokoju dziecięcego, pokoju osób starszych czy w korytarzach.

Materiał obudowy: tworzywo sztuczne

Materiał klosza: tworzywo sztuczne

Kanlux UL OV LED is a plug-in lamp in which the light intensity can be smoothly adjusted. It has a built-in dusk sensor (automatically turns the light on and off). Its friendly design means that we can place it in bedrooms, children's rooms, elderly people's rooms or in corridors.

Enclosure material: plastic

Lampshade material: plastic

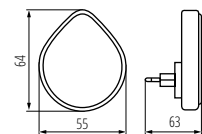

UL OV LED DIM WW W

Kanlux

ORISA LED

LAMPKA WTYKOWA LED ► LED PLUG-IN LAMP

NEW



ORISA LED WW W

ORISA LED WW B



ORISA LED WW W	37394	5905339373946	0,28	5	3000	biały white
ORISA LED WW B	37395	5905339373953	0,28	5	3000	czarny black

[V] 220-240 AC	[Hz] 50	ellipso ≤ 6x Max diam	Hg	SMD		
IP 20	Im W 18	CE	ERC	UK CA		



Kanlux ORISA LED to stylowa lampka wtykowa z czujnikiem zmierzchowym (automatyczne włączenie i wyłączenie w zależności od ilości dostępnego światła dziennego). Jest idealna do umieszczenia w gniazdkach sypialni, pokoju dziecięcym, pokoju osób starszych lub korytarzach. Lampka emituje delikatne światło (5 lumenów), a jej elegancki design będzie dodatkową ozdobą oświetlanego miejsca.

Materiał obudowy: PC

Kanlux ORISA LED is a stylish plug-in lamp with a twilight sensor (automatic switching on and off depending on the amount of available daylight). It is ideal for placing in bedrooms, children's rooms, elderly people's rooms or corridors. The lamp emits delicate light (5 lumens), and its elegant design will be an additional decoration of the illuminated place.

Enclosure material: PC

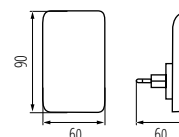

ORISA LED WW

Kanlux

HOFI LED

LAMPKA WTYKOWA LED ► LED PLUG-IN LAMP

NEW



HOFI LED WW W



HOFI LED WW W	37393	5905339373939	0,28	2	3000	biały white
---------------	--------------	---------------	------	---	------	---------------

[V] 220-240 AC	[Hz] 50	ellipso ≤ 6x Max diam	Hg	SMD		
IP 20	Im W 7	CE	ERC	UK CA		



Kanlux HOFI LED to lampka wtykowa z czujnikiem zmierzchowym, odpowiednia do umieszczenia w gniazdkach przy schodach, w korytarzach, sypialniach, pokojach dziecięcych. Strumień świetlny lampki to 2 lumeny (bardzo delikatne światło), można podłączyć ją w gniazdku, na dwa sposoby, aby światło padało w dół lub w górę.

Materiał obudowy: PC

Materiał klosza: PC

Kanlux HOFI LED is a plug-in lamp with a twilight sensor, suitable for placing in sockets near the stairs, in corridors, bedrooms and children's rooms. The luminous flux of the lamp is 2 lumens (very delicate light), you can connect it to the socket in two ways, so that the light falls down or up.

Enclosure material: PC

Lampshade material: PC

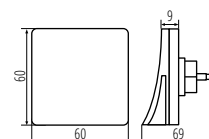

HOFI LED WW W

Kanlux

CALIZA LED

OPRAWA ŚCIENNA LED ► LED WALL MOUNTED FITTING

NEW



CALIZA LED CCT W



CALIZA LED CCT W | 37390 | 5905339373908 max 2 biały | white

3,7 DC ACCU	max 160	≥15000	25000	3000/4000/6500	elipse ≤ 60 MacAdam	80	SMD
	IP 20		5+25	180	0,1m		
	max 80						



Kanlux CALIZIA LED to nowoczesny kinkiet ze strumieniem świetlnym 160 lm, który ładowany jest przez USB C (w komplecie znajduje się przewód o długości 220mm). Podstawę kinkietu zamocujesz na ścianie lub szafce przy pomocy taśmy lub 2 śrub (dołączone do zestawu), a samą część świecącą bez problemu odłączysz (uchwyt magnetyczny) do ładowania. Przydatną funkcją w kinkiecie Kanlux CALIZIA LED jest zmiana natężenia i barwy światła. Kanlux CALIZIA LED przyda Ci się w miejscach gdzie nie masz wyprowadzonej instalacji, jako lampa meblowa lub przenośna. Czas działania lampy wynosi maksymalnie 5h.

Materiał obudowy: tworzywo sztuczne
Materiał klosza: tworzywo sztuczne

Kanlux CALIZIA LED is a modern wall lamp with a luminous flux of 160 lm, which is charged via USB C (the set includes a 220 mm cable). You can attach the base of the wall lamp to the wall or cabinet using tape or 2 screws (included in the set), and you can easily detach the lighting part (magnetic holder) for charging. A useful function of the Kanlux CALIZIA LED wall lamp is the change of light intensity and color. Kanlux CALIZIA LED will be useful in places where there is no installation, as a furniture or portable lamp. The lamp operating time is a maximum of 5 hours.

Enclosure material: plastic
Lampshade material: plastic

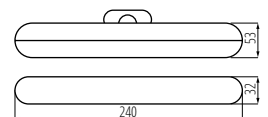

CALIZA LED CCT W

Kanlux GALOBA W

OPRAWA ŚCIENNA ► WALL-MOUNTED LIGHT FITTING

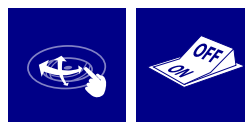

GALOBA W 1xGU10 B



GALOBA W 1xGU10 W

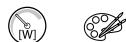

GALOBA W 1xGU10 W	33672	5905339336729	max 35	biały white
GALOBA W 1xGU10 B	33673	5905339336736	max 35	czarny black

[V]	[Hz]	PAR16	GU10	IP 20	5+25	CE	EAC	UK CA
220-240 AC	50							
335	315	0,75x1,5	0,5m					

Kanlux GALOBA to kompletna seria opraw oświetleniowych, na którą składają się lampy wiszące (GALOBA C), kinkiety (GALOBA W) i oprawy ściennie-sufitowe. Lampy wiszące Kanlux GALOBA C z powodzeniem zastosujesz w oświetleniu wysp lub stołów, oprawy ściennie-sufitowe GALOBA (od 1 do 4 punktów świetlnych) możesz zastosować w salonie, holu czy sypialni. Dopelnieniem aranżacji staną się kinkiety GALOBA W, które mają włącznik w podstawie. Cała seria opraw Kanlux GALOBA posiada rozkręcany klosz, dzięki czemu szybko i wygodnie wymienimy źródła światła. Maksymalna wysokość źródła światła do opraw GALOBA to 55mm. Polecamy zastosowanie źródeł Kanlux SMART (S GU10) lub iQ-LED LIFE (iQ LED L GU10).

Maksymalna wysokość źródła światła 55 mm

Materiał obudowy: stop aluminium

Kanlux GALOBA is a complete series of luminaires, including pendant lamps (GALOBA C), wall lamps (GALOBA W) and wall and ceiling fixtures. Kanlux GALOBA C pendant lamps can be successfully used for the lighting of islands or tables, while wall and ceiling lamps (from 1 to 4 points of light) can be used in a living room, hall or bedroom. The arrangement can be completed with wall lamps, which have a switch in the base. All luminaires from the Kanlux GALOBA series have a detachable lampshade thanks to which the light sources can be quickly and comfortably replaced.

Maximum light-source height 55 mm

Enclosure material: aluminum alloy

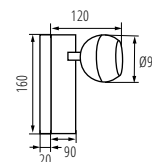

GALOBA W

Kanlux TONIL II LED

OPRAWA ŚCIENNA LED ► LED WALL MOUNTED FITTING



TONIL II LED B



TONIL II LED W



TONIL II LED B	32522	5905339325228	3,3	czarny black
TONIL II LED W	32523	5905339325235	3,3	biały white

[V]	[Hz]	lm	[°]	[h]	Tc [K]	≤ 6lx Maxdram	Ra	SMD	IP 20
220-240 AC	50	145	30	≥15000	20000	3000	80		
5+25	360	360	0,5-1,5	0,2m			44		



Kanlux TONIL LED II to skromny w formie kinkiety ze zintegrowanym źródłem światła. Jego wyróżnikiem jest elastyczne, gumowe ramie, które umożliwi skierowanie oświetlenia w pożądanym kierunku. Jednocześnie dodatkowym wyróżnikiem jest fakt, że możemy uformować z niego pożądaną kształt.

Materiał obudowy: stop aluminium

Materiał klosza: tworzywo sztuczne

Kanlux TONIL LED II is a modest in form model with an integrated light source. Its flexible, rubber arm allows you to direct the lighting in the desired direction. At the same time, we can give it the desired shape.

Enclosure material: aluminum alloy

Lampshade material: plastic

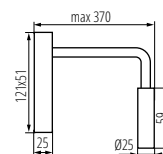

TONIL II LED

Kanlux

AGZAR EL

OPRAWA ŚCIENNO-SUFITOWA ► WALL & CEILING LIGHTING FITTING



AGZAR EL-10 B

AGZAR EL-10 W



AGZAR EL-10 B	36254	5905339362544	max 5	czarny black
AGZAR EL-10 W	36255	5905339362551	max 5	biały white

[V] 220-240 AC	[Hz] 50		E14		IP 20			5÷25	
345	105		1+2,5	0,5m					



AGZAR EL 10

Kanlux

AGZAR E14

LAMPA STOŁOWA ► TABLE LAMP



AGZAR E14 B

AGZAR E14 W



AGZAR E14 B	36250	5905339362506	max 5	czarny black
AGZAR E14 W	36251	5905339362513	max 5	biały white

[V] 220-240 AC	[Hz] 50		E14		IP 20			5÷25		
180			1,45	0,1m						180

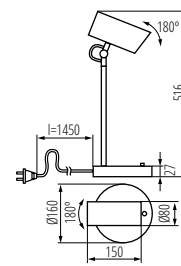

AGZAR E14



HIGH
quality
finish

DESIGN
unique

Kanlux AGZAR EL to jednopunktowy spot wykonany ze stali. Niewątpliwym atutem tych opraw poza nowoczesnym wzornictwem jest możliwość szerokiego obrotu klosza. Przewody są w materiałowym oplocie, a lampa wykonana jest z dbałością o każdy detal. Kanlux AGZAR EL dostosowany jest do źródła światła o trzonku E14 i maksymalnej mocy 5W.

Materiał obudowy: stal

Kanlux AGZAR EL is a single-point spot made of steel. The big advantage of these fittings, apart from modern design, is the ability to rotate the lampshade. The cables are braided and the lamp is made with attention to every detail. Kanlux AGZAR EL is adapted to a light source with an E14 cap and a maximum power of 5W.

Enclosure material: steel



HIGH
quality
finish

DESIGN
unique

Lampa stołowa Kanlux AGZAR E14 to lampa stołowa wykonana ze stali. Jej niewątpliwym atutem jest możliwość szerokiego obrotu klosza. Przewody są w materiałowym oplocie, a lampa wykonana jest z dbałością o każdy detal. Kanlux AGZAR E14 dostosowany jest do źródła światła o trzonku E14 i maksymalnej mocy 5W. To lampa, która swoim nowoczesnym designem zachwyci miłośników stylu klasycznego jak i nowoczesności. Dbałość o każdy detal i stalowa konstrukcja czynią z tej lampy produkt klasy PREMIUM.

Materiał obudowy: stal

The Kanlux AGZAR E14 table lamp is a table lamp made of steel. Its unquestionable advantage is the ability to rotate the lampshade. The cables are braided and the lamp is made with attention to every detail. Kanlux AGZAR E14 is adapted to a light source with an E14 cap and a maximum power of 5W. It is a lamp that will delight lovers of classic and modern styles with its modern design. Attention to every detail and steel structure make this lamp a PREMIUM class product.

Enclosure material: steel

Kanlux

LARATA EL

OPRAWA ŚCIENNO-SUFITOWA ► WALL & CEILING LIGHTING FITTING



LARATA EL-10 W

LARATA EL-10 B



LARATA EL-10 W	36262	5905339362629	max 5	biały white
LARATA EL-10 B	36263	5905339362636	max 5	czarny black

[V] 220-240 AC	[Hz] 50						

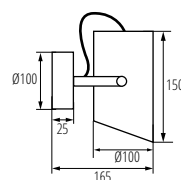

LARATA EL-10



HIGH
quality
finish

DESIGN
unique

Kanlux LARATA EL to jednopunktowy spot, który może być stosowany jako oświetlenie sufitowe, ale też jako ściennie. Obudowa jest wykonana ze stali z dbałością o każdy detal. Lampy serii LARATA to produkty premium, które sprostają wymaganiom największych nawet estetów.

Materiał obudowy: metal

Kanlux LARATA EL is a single-point spot that can be used as ceiling lighting, but also as wall lighting. The housing is made of steel with attention to every detail. LARATA lamps are premium products that meet the requirements of even the greatest aesthetes.

Enclosure material: Metal

Kanlux

LARATA E27

LAMPA STOŁOWA ► TABLE LAMP



LARATA E27 W

LARATA E27 B



LARATA E27 W	36260	5905339362605	max 5	biały white
LARATA E27 B	36261	5905339362612	max 5	czarny black

[V] 220-240 AC	[Hz] 50						

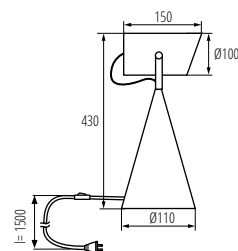

LARATA E27



HIGH
quality
finish

DESIGN
unique

Kanlux LARATA E27 to lampa stołowa, która wykonana jest ze stali. Wykonanie i sama obudowa dodają lampie elegancji i nowoczesnego wyglądu. Lampa stołowa Kanlux LARATA to produkt wyjątkowy, wykonany z dbałością o każdy detal. Dzięki swojemu ciężarowi lampa stabilnie utrzymuje się na powierzchni i nie kołysze się. Regulacja ramienia odbywa się z pomocą dwóch eleganckich śrub, a widoczny przewód umieszczony jest w estetycznym oplocie.

Materiał obudowy: metal

Kanlux LARATA E27 is a table lamp made of steel. The finish and the housing itself add elegance and a modern look to the lamp. The Kanlux LARATA table lamp is a unique product, made with attention to every detail. Due to its weight, the lamp remains stable on the surface and does not sway. The arm is adjusted with the help of two elegant screws, and the visible cable is placed in an aesthetic braid.

Enclosure material: Metal

FLUXY LED IP44

LAMPA STOŁOWA LED ► LED TABLE LAMP

NEW



FLUXY LED IP44 GN



FLUXY LED IP44 W



FLUXY LED IP44 B



FLUXY LED IP44 BL



FLUXY LED IP44 Y



FLUXY LED IP44 W	37310	5905339373106	max 1,7	max 140	3000	biały white
FLUXY LED IP44 B	37311	5905339373113	max 1,7	max 140	3000	czarny black
FLUXY LED IP44 BL	37312	5905339373120	max 1,7	max 140	3000	niebieski blue
FLUXY LED IP44 GN	37313	5905339373137	max 1,7	max 140	3000	zielony green
FLUXY LED IP44 Y	37314	5905339373144	max 1,7	max 140	3000	żółty yellow

3,7 DC 18650 ACCU	80	SMD	DIMMING function	IP 44	UKCA	
0,1m	max 82					



Kanlux FLUXY LED to typ multifunkcyjnej bezprzewodowej lampki stołowej. Ma bardzo nowoczesny, a zarazem elegancki wygląd, jest lekka i łatwa w transporcie, a do tego idealnie nadaje się do użytku wewnątrz i na zewnątrz dzięki klasie szczelności IP44. Lampkę Kanlux FLUXY obsłużysz za pomocą jednego przycisku (włącz/wyłącz/funkcja ściemniania) i naładujesz za pomocą portu USB - C.

Materiał obudowy: tworzywo sztuczne, metal

Materiał klosza: tworzywo sztuczne

Kanlux FLUXY LED is a type of multifunctional wireless table lamp. It has a very modern and elegant look, is light and easy to transport, and is ideal for indoor and outdoor use thanks to the IP44 class. You can operate the Kanlux FLUXY lamp with one button (on/off/dimming function) and charge it via the USB-C port.

Enclosure material: plastic, Metal

Lampshade material: plastic

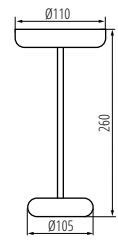

FLUXY LED IP44

Kanlux

INITA LED IP54

LAMPA STOŁOWA LED ► LED TABLE LAMP

NEW



INITA LED IP54 B



INITA LED IP54 GN



INITA LED IP54 R



INITA LED IP54 Y



INITA LED IP54 W



INITA LED IP54 GN	36320	5905339363206	max 1,2	max 165	3000	zielony green
INITA LED IP54 B	36321	5905339363213	max 1,2	max 165	3000	czarny black
INITA LED IP54 R	36322	5905339363220	max 1,2	max 165	3000	czerwony red
INITA LED IP54 Y	36323	5905339363237	max 1,2	max 165	3000	żółty yellow
INITA LED IP54 W	36324	5905339363244	max 1,2	max 165	3000	biały white

[VI] 3,7 DC 18650 ACCU		 ≥15000	 25000	 Ra 80	 SMD	 DIMMING function
	IP 54	 -10+35				 0,1m
 max 138	CE	ERAC	UK CA			



Kanlux INITA LED to nowy typ multifunkcyjnej, bezprzewodowej lampy stołowej. Metalowy korpus, delikatna, matowa tekstura i jednolity kolor to tylko niektóre jej walory. Lampkę Kanlux INITA obsłużysz za pomocą jednego przycisku (włącz/wyłącz/funkcja ściemniania) i naładujesz za pomocą portu USB. Tę lampkę możesz ze sobą zabrać także na taras czy do ogrodu dzięki szczelności IP54. Lampkę stołową Kanlux INITA szybko i prosto złożysz, a także rozłożysz i zmieścisz do bagażu - jeżeli będziesz chciał ją zabrać w podróż.

Materiał obudowy: metal

Materiał klosza: stop aluminium

Kanlux INITA LED is a new type of multifunctional, wireless table lamp. The metal body, delicate, matte texture and uniform color are just some of its advantages. You can operate the Kanlux INITA lamp with one button (on/off/dimming function) and charge it via the USB port. You can also take this lamp with you to the terrace or to the garden thanks to the IP54 tightness. The Kanlux INITA table lamp can be quickly and easily folded, unfolded and stored in your luggage - if you want to take it on a journey.

Enclosure material: Metal

Lampshade material: aluminum alloy

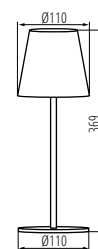

INITA LED IP 54

Kanlux

EVALO TL

LAMPA STOŁOWA ► TABLE LAMP

NEW



EVALO TL GU10 W-SR



EVALO TL GU10 B-SR



EVALO TL to lampka stołowa należąca do serii lamp Kanlux EVALO. Skandynawska wręcz prostota i srebrne przeguby tworzą wysoce elegancką klasykę. Wąski klosz mieści w sobie źródła GU10 (w komplecie dodajemy przyssawkę, która ułatwia ich montaż). Lampę Kanlux EVALO TL możesz komponować ze spotami Kanlux EVALI i lampami stojącymi Kanlux EVALO FL.

Materiał obudowy: stop aluminium

EVALO TL is a table lamp belonging to the Kanlux EVALO lamp series. Scandinavian simplicity and silver joints create a highly elegant classic. The narrow lampshade houses GU10 light sources (the set includes a suction cup that makes their installation easier). You can combine the Kanlux EVALO TL lamp with Kanlux EVALI spots and Kanlux EVALO FL floor lamps.

Enclosure material: aluminum alloy



EVALO TL GU10 W-SR	35785	5905339357854	max 10	biały white
EVALO TL GU10 B-SR	35786	5905339357861	max 10	czarny black

[V]	[Hz]	PAR16	GU10	Light bulb icon	Wiring diagram icon	IP icon
220-240 AC	50	PAR16	GU10	Light bulb icon	Wiring diagram icon	IP icon
IP 20	House icon	Temperature icon	Light bulb icon	Light bulb icon	Light bulb icon	Light bulb icon
IP 20	House icon	5+25	320	90	Light bulb icon	Light bulb icon
Light bulb icon	1,5	0,1m	CE	ERL	UK	Light bulb icon

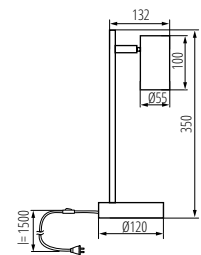

EVALO TL GU10

Kanlux

EVALO FL

LAMPA PODŁOGOWA ► FLOOR LAMP

NEW

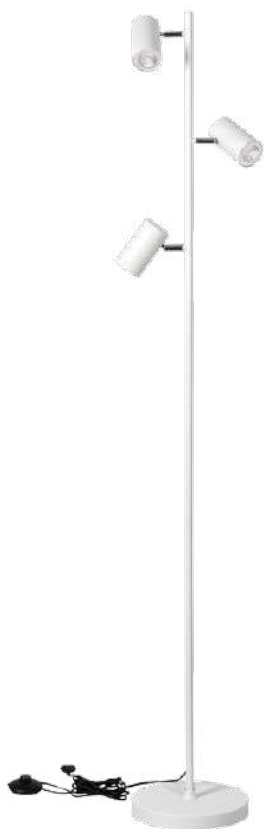

EVALO FL 3xGU10 W-SR

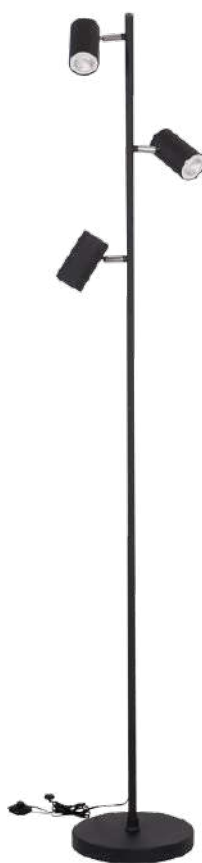

EVALO FL 3xGU10 B-SR



EVALO FL to lampa stojąca należąca do serii lamp Kanlux EVALO. Skandynawska wręcz prostota i srebrne przeguby tworzą wysoce elegancką klasykę. Wąskie klosze (lampa posiada 3 punkty świetlne) mieści w sobie źródła GU10 (w komplecie przyssawka, która ułatwia ich montaż). Lampę Kanlux EVALO FL możesz komponować ze spotami Kanlux EVALI i lampami stołowymi Kanlux EVALO TL.

Materiał obudowy: stop aluminium

EVALO FL is a floor lamp belonging to the Kanlux EVALO lamp series. Scandinavian simplicity and silver joints create a highly elegant classic. The narrow lampshade (the lamp has 3 light points) houses GU10 light sources (a suction cup is included, which makes their installation easier). You can combine the Kanlux EVALO FL lamp with Kanlux EVALI spots and Kanlux EVALO TL table lamps.

Enclosure material: aluminum alloy



EVALO FL 3xGU10 W-SR	35787	5905339357878	3 x max 10	biały white
EVALO FL 3xGU10 B-SR	35788	5905339357885	3 x max 10	czarny black

[V] 220-240 AC	[Hz] 50	PAR16	GU10	Lightbulb icon	Lightbulb icon	Lightbulb icon
IP 20	House icon	Temperature icon 5+25	Lightbulb icon	320	90	Lightbulb icon
Lightbulb icon	1,8	0,5m	CE	ERL	UK CA	Lightbulb icon

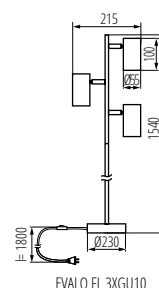

EVALO FL 3xGU10

Kanlux

RAIBO E27

LAMPKA BIURKOWA ► DESK LAMP



RAIBO E27 B



RAIBO E27 W



RAIBO E27 BL



RAIBO E27 Y



RAIBO E27 GN



RAIBO E27 PK



RAIBO E27 B	36280	5905339362803	max 5	czarny black
RAIBO E27 W	36281	5905339362810	max 5	biały white
RAIBO E27 BL	36282	5905339362827	max 5	niebieski blue
RAIBO E27 Y	36283	5905339362834	max 5	żółty yellow
RAIBO E27 GN	36284	5905339362841	max 5	zielony green
RAIBO E27 PK	36285	5905339362858	max 5	różowy pink

[VI] 220-240 AC	[Hz] 50			IP 20	 0,1m			
 190			 1,5	CE	EMC	UK		



Kanlux RAIBO to modna retro lampka biurkowa. Dostępna jest w 4 pastelowych kolorach, jak i w popularnej czerni i bieli. W podstawie wbudowany jest organizator z uchwytem, w który możemy odłożyć telefon, długopisy czy okulary. Duży klosz, w którym zmieścimy żarówkę o trzonku E27 to szeroki rozsył światła. Widoczny jest tu wpływ retro, ale również dbałość o szczegóły i solidne wykonanie (stal). Zwróciliśmy też uwagę na spód lampki i dodaliśmy piankową podkładkę, aby lampka nie rysowała biurka.

Materiał obudowy: metal

Kanlux RAIBO is a fashionable retro desk lamp. It is available in 4 pastel colors as well as in the popular black and white. The base has a built-in organizer with a handle in which you can put a phone, pens or glasses. A large lampshade, in which we can fit a bulb with an E27 base, is a wide light distribution. The retro influence is visible here, but also attention to detail and a solid finish (steel). We also paid attention to the underside of the lamp and added a foam pad to keep the lamp from scratching the desk.

Enclosure material: Metal

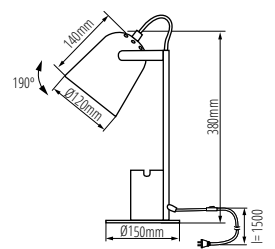

RAIBO E27

Kanlux JUSI E27

LAMPA STOŁOWA ► TABLE LAMP



JUSI E27 W



JUSI E27 B



JUSI E27 W	36270	5905339362704	max 5	biały white
JUSI E27 B	36271	5905339362711	max 5	czarny black

[V]	[Hz]	E27	IP	5+25	180°
220-240 AC	50		20		



Lampka stołowa Kanlux JUSI E27 z powodzeniem może być wykorzystywana jako lampa biurkowa, nocna, lub jako dodatkowe oświetlenie pomieszczeń. Design tej lampki jest tak uniwersalny, że idealnie wpasuje się zarówno do pokoju młodzieżowego jak i do salonu czy sypialni. Sami decydujemy o mocy światła i jego barwie, a tu mamy bardzo szerokie możliwości, bo do lampki pasują żarówki o trzonku E27. Stalowa obudowa i włącznik zamontowany na przewodzie zasilającym to jej dodatkowe atuty. Nowością jest możliwość wychylenia ramienia względem podstawy o 40 stopni, sam klosz wychyliłmy dodatkowo o 180 stopni.

Materiał obudowy: metal

The Kanlux JUSI E27 table lamp can be successfully used as a desk lamp, bedside lamp, or as additional room lighting. The design of this lamp is so universal that it will fit perfectly into a youth room as well as a living room or bedroom. We decide on the power of light ourselves thanks to the possibility of replacing the bulb with E27 cap. A steel housing and a switch mounted on the power cord are its additional advantages. A novelty is the possibility of tilting the arm by 40 degrees, the lampshade itself can be tilted additionally by 180 degrees.

Enclosure material: Metal

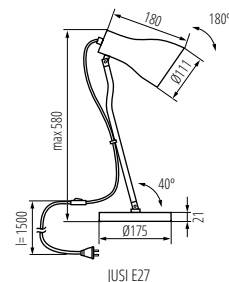

Kanlux NEDIA E14

LAMPA STOŁOWA ► TABLE LAMP



NEDIA E14 B



NEDIA E14 W

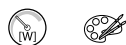

NEDIA E14 B	34475	5905339344755	max 10	czarny black
NEDIA E14 W	34476	5905339344762	max 10	biały white

[V]	[Hz]	E14	IP	5+25	320
220-240 AC	50		20		



KANLUX NEDIA to lampa stołowa z wymiennym źródłem światła o trzonku E14. Stylowa forma tej lampy sprawdzi się jako funkcjonalne wyposażenie miejsca nauki i pracy. Kanlux NEDIA doda także dekoracyjności w sypialni i gabinecie. Może być ona również niezastąpionym dodatkowym oświetleniem w Twoim salonie. Dodatkowym atutem jest regulowany przegub w kolorze srebrnym i wysoka jakość wykonania lampy. Kanlux NEDIA posiada mechaniczny przełącznik ON/OFF umieszczony na przewodzie zasilającym.

Materiał obudowy: stal

KANLUX NEDIA is a table lamp with a replaceable light source with an E14 cap. The stylish form of this lamp will prove to be a functional accessory for your learning and working space. Kanlux NEDIA will also add decorativeness to a bedroom and a study. It can also constitute invaluable additional lighting for your living room. An additional advantage is an adjustable silver joint and the high quality of workmanship. Kanlux NEDIA has a mechanical ON/OFF switch located on the power cord.

Enclosure material: steel

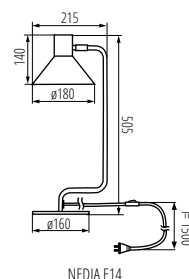

Kanlux PIXA

LAMPKA BIURKOWA ► DESK LAMP



PIXA KT-40-W

PIXA KT-40-B



PIXA KT-40-W	19300	5905339193001	max 40	biały white
PIXA KT-40-B	19301	5905339193018	max 40	czarny black

[V] 220-240 AC	[Hz] 50			IP 20	 0,1m			
 360	 180	 1,6						

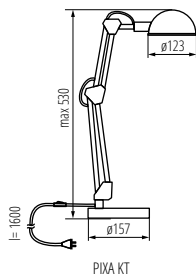

PIXA KT



Kanlux PIXA to kultowa lampka biurkowa na wymienne źródło światła. Jej budowa pozwala skierować strumień świetlny w dowolnym kierunku przy czym klosz lampki ogranicza jego padanie na boki. Lampka ta doskonale wpisze się w każdy rodzaj wnętrza - od pokoju dziecięcego po biurko w gabinecie prezesa.

Materiał obudowy: tworzywo sztuczne, metal
Materiał klosza: metal

Kanlux PIXA is a cult desk lamp with a replaceable light source. Its structure allows directing the light stream into any direction with the reservation that the lampshade of the lamp reduces its falling aside. This lamp will perfectly fit into each type of interiors - from a child's room to a desk in an office of a president.

Enclosure material: plastic, Metal
Lampshade material: Metal

Kanlux HERON II LED

LAMPKA BIURKOWA LED ► LED DESK LAMP



HERON II LED B

HERON II LED W



HERON II LED B	27602	5905339276025	4,8	czarny black	430	4000
HERON II LED W	27603	5905339276032	4,8	biały white	430	4000

[V] 220-240 AC	[Hz] 50	 110	 ≥15000	 20000	 ≤ 6x Maczkdam	 80		
	IP 20	 0,1m			 360	 180	 1,7	
	 90							



HERON II to nowa wersja znanej lampki biurkowej LED z mniejszym użyciem mocy, ale o większym strumieniu świetlnym. Wyróżnia ją przede wszystkim ponadprzeciętna możliwość regulacji padania strumienia światła, a to dzięki jej regulowanym przegubom- mamy swobodną możliwość obrotu ramienia lampki. HERON II LED posiada wyłącznik umieszczony na kloszu oraz zacisk, który pozwala przytwierdzić podstawę do krawędzi blatu lub półki. Kanlux HERON II LED cieszy się zainteresowaniem osób, które cenią sobie nowoczesny, surowy design. Sprawdzi się na biurku ucznia, studenta, a także przy wymagającej oświetlenia pracy.

Materiał obudowy: stop aluminium
Materiał klosza: tworzywo sztuczne

HERON II is a new version of the well-known LED desk lamp with lower power consumption but higher light output. It is distinguished above all by the extraordinary adjustability of the light beam, thanks to its adjustable joints - the lamp arm can be rotated freely. HERON II LED has an on/off switch located on the lamp shade and a clamp that allows you to fix the base to the edge of a table top or shelf. Kanlux HERON II LED is very popular among people who appreciate modern, austere design. It will prove useful on a pupil's or student's desk, as well as at work requiring lighting.

Enclosure material: aluminum alloy
Lampshade material: plastic

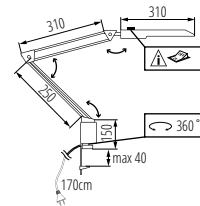

HERON II LED

Kanlux ZARA

LAMPKA BIURKOWA ► DESK LAMP



ZARA HR-40-B

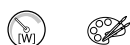

ZARA HR-40-SR	07560	5905339075604	max 40	srebrny silver
ZARA HR-40-B	07561	5905339075611	max 40	czarny black
ZARA HR-40-W	07564	5905339075642	max 40	biały white

NEW

[V]	[Hz]			IP				
220-240 AC	50			20	0,2m		E14	
360	360	1,5						



ZARA HR-40-SR



ZARA HR-40-W

NEW



Seria lampek biurkowych Kanlux ZARA to kultowy już model, który od lat cieszy się niesłabnącym powodzeniem. Dzięki swojej prostocie i klasycznemu wyglądowi lampka ta idealnie będzie wyglądać na każdym biurku. Jej zaletą są również klasyczne kolory i samodzielna możliwość dopasowania źródła światła o gwincie E14.

Materiał obudowy: stal
Materiał klosza: stal

The family of Kanlux ZARA desk lamps is a cult model that has enjoyed unflagging popularity for years. Thanks to its simplicity and classic look, this lamp will look perfect on any desk. Its advantage is also the classic colors and the possibility of self-adjustment of the light source with the E14 socket.

Enclosure material: steel
Lampshade material: steel

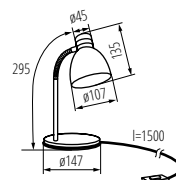

ZARA HR-40

Kanlux SUZI

LAMPKA BIURKOWA ► DESK LAMP



SUZI HR-60-B



SUZI HR-60-SR	07150	5905339071507	max 40	srebrny silver
SUZI HR-60-B	07151	5905339071514	max 40	czarny black
SUZI HR-60-BL	07152	5905339071521	max 40	niebieski blue
SUZI HR-60-PK	07153	5905339071538	max 40	różowy pink
SUZI HR-60-W	07154	5905339071545	max 40	biały white

NEW

[V]	[Hz]			IP				
220-240 AC	50			20	0,2m		E27	
360	360	1,5						



SUZI HR-60-SR



SUZI HR-60-BL



SUZI HR-60-PK



SUZI HR-60-W

NEW



Kanlux SUZI to prosta lampka biurkowa. Dostępna jest w kilku jednolitych wersjach kolorystycznych. Kanlux SUZI posiada regulowane ramię i klips dzięki któremu możemy umocować lampkę na krawędzi biurka lub na półce.

Wysięgnik giętki
Montaż za pomocą klipsa
Materiał obudowy: tworzywo sztuczne
Materiał klosza: stal

Kanlux SUZI is a simple desk lamp. It is available in several uniform colour versions. Kanlux SUZI has an adjustable arm and a clip thanks to which you can fix the lamp on a desk edge or on a shelf.

Flexible exterior arm
Clip-on installation
Enclosure material: plastic
Lampshade material: steel

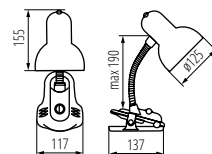

SUZI HR-60

Kanlux

PREDA LED

LAMPKA BIURKOWA LED ► LED DESK LAMP



PREDA LED B



PREDA LED W



Kanlux PREDA to multifunkcyjna lampa biurkowa. Wyróżnia ją wysoki (jak dla lampek biurkowych) strumień świetlny - aż do 620 lumenów (model biały). Charakteryzuje się ona możliwością płynnej zmiany natężenia (suwak) i barwy światła. Cechą unikatową jest możliwość odchylenia ramienia lampy wokół własnej osi o 45 stopni. Lampa wyposażona jest w port USB, dzięki któremu naładujemy urządzenia mobilne. Tę lampę z powodzeniem zastosujesz do oświetlenia biurka ucznia lub większego miejsca pracy. Może mieć także zastosowanie w gabinetach kosmetycznych.

Materiał obudowy: tworzywo sztuczne

Materiał klosza: tworzywo sztuczne

Materiał wysięgnika: tworzywo sztuczne

Kanlux PREDA is a multifunctional desk lamp. It is distinguished by a high (as for desk lamps) luminous flux - up to 620 lumens (white model). It is characterized by a smooth color change (slider) and the ability to change the color of the light. A unique feature is the possibility of deflecting the lamp arm around its axis by 45 degrees. The lamp is equipped with a USB port, thanks to which we can charge mobile devices. This lamp can be successfully used to illuminate a student's desk or a larger workplace. It can also be used in beauty salons.

Enclosure material: plastic

Lampshade material: plastic

Extension-arm material: plastic



PREDA LED B	35780	5905339357809	max 7,3	czarny black	max 570	3000/5000/6500
PREDA LED W	35781	5905339357816	max 7,3	biały white	max 620	3000/5000/6500

[V]	[Hz]	[W]	[h]	[lm]	[Ra]	[SMD]	[DIMMING function]
220-240 AC	50	15000	25000	5000	80	SMD	DIMMING function
[IP]	[°]	[°]	[°]	[°]	[°]	[°]	[lm]
IP 20	45	150	45	150	45	150	1,8
CE	ERC	UK CA					

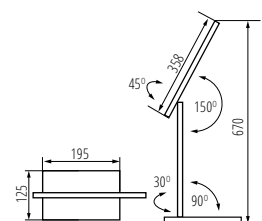

PREDA LED

Kanlux REXAR LED

LAMPKA BIURKOWA LED ► LED DESK LAMP



REXAR LED B

REXAR LED W



Lampka biurkowa Kanlux REXAR to minimalistyczny, elegancki design i mnóstwo funkcji. Możemy dowolnie regulować barwę światła i jego natężenie, a także skorzystać z portu USB aby doładować urządzenie mobilne. Po skończonej pracy złożona lampka nie zajmie dużo miejsca i będzie pełnić funkcję minimalistycznej ozdoby.

Materiał obudowy: stop aluminium, tworzywo sztuczne

Kanlux REXAR desk lamp combines a minimalist, elegant design and plenty of functions. You can adjust the colour of the light and its intensity to suit your preferences, as well as use the USB port in order to charge a mobile device. Once it is switched off, a folded lamp does not occupy much space and serves as an uncluttered decoration.

Enclosure material: aluminum alloy, plastic

REXAR LED W	33070	5905339330703	max 7	biały white	max 420	3000/4000/6500
REXAR LED B	33071	5905339330710	max 7	czarny black	max 370	3000/4000/6500

[V] 220-240 AC	[Hz] 50	[°] 100	[lm] ≥15000	[h] 25000	[Ra] ≤6x Max/dam	[Ra] 80	[SMD]	[Tc [K]]
DIMMING function	[IP] 20	[m] 0,1m	[°] 180	[m] 1,8	[m]	[m]	[m]	[m]
[CE]	[EAC]	[UK CA]	[UK CA]	[UK CA]	[UK CA]	[UK CA]	[UK CA]	[UK CA]

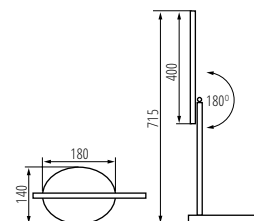

REXAR LED

Kanlux FRANCO II / FRANCO LED

LAMPKA BIURKOWA LED ► LED DESK LAMP



FRANCO B

FRANCO W



FRANCO II LED W	22342	5905339223425	max 6,5	biały white	max 590	3000
FRANCO II LED B	22343	5905339223432	max 6,5	czarny black	max 590	3000
FRANCO 15LED SMD KT-W	22340	5905339223401	max 6,5	biały white	max 390	3000
FRANCO 15LED SMD KT-B	22341	5905339223418	max 6,5	czarny black	max 390	3000

[V] 220-240 AC	[Hz] 50	[°] 100	[lm] ≥10000	[h] 20000	[Ra] ≤6x Max/dam	[Ra] 80	[SMD]	[Tc [K]]
DIMMING function	[IP] 20	[m] 0,1m	[°] 360	[m] 360	[m]	[m]	[m]	[m]
[CE]	[EAC]	[UK CA]	[UK CA]	[UK CA]	[UK CA]	[UK CA]	[UK CA]	[UK CA]



Kanlux FRANCO to opływowa w kształcie, dyskretna, a zarazem elegancka lampka stojąca. Świetna jako oświetlenie biurkowe, ale również jako dodatkowe oświetlenie pomieszczenia czy lampka nocna. Wygodnym rozwiązaniem jest możliwość regulacji natężenia światła, dzięki której możemy dopasować jasność oświetlenia do własnych potrzeb i pory dnia.

Wyposażona w sensor umieszczony w podstawie, dzięki któremu poprzez dotyk można włączyć/wyłączyć lampkę lub ustawić intensywność świecenia (3 stopnie jasności)

Materiał obudowy: tworzywo sztuczne

Materiał klosza: tworzywo sztuczne

Kanlux FRANCO is a streamlined, in terms of shape, discrete and at the same time elegant standing lamp. It works perfectly as the desk lighting and also as the additional lighting of a room or a bedside lamp. A possibility of adjusting the intensity of light is a convenient solution, thanks to which you can adapt brightness of light to own needs and time of day.

The base plate is provided with a sensor that enables switching on/off the lamp or controlling the light intensity by touch (3 brightness levels)

Enclosure material: plastic

Lampshade material: plastic

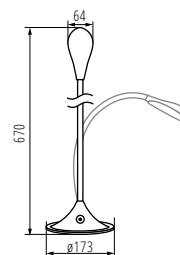

FRANCO

GLOZO DSO

PIERŚCIEŃ OPRAWY PUNKTOWEJ ► RING FOR SPOTLIGHT FITTINGS



GLOZO DSO W/W



GLOZO DSO B/W



GLOZO DSO G/W



GLOZO DSO SR/W



GLOZO DSO B/B



GLOZO DSO G/B



GLOZO DSO SR/B



GLOZO DSO W/B



Kanlux GLOZO to duża rodzina pierścieni dekoracyjnych. Mają one modułową obudowę: podstawę w dwóch kształtach i kolorach oraz odbłyśnik w 4 kolorach w matie lub błysku. Daje nam to bardzo dużo możliwości aranżacji zestawiania ze sobą tych samych lub różnych rozwiązań kolorystycznych.

Pierścień dekoracyjny bez oprawki ceramicznej

Materiał obudowy: stop aluminium

Kanlux GLOZO is a large family of decorative rings. They have a modular housing: a base in two shapes and colors and a reflector in 4 colors in mat or mirror finish. It gives us a lot of possibilities to arrange the combination of the same or different color solutions.

Decorative ring without a ceramic frame
Enclosure material: aluminum alloy



Model	Code	Part No.	Max. Depth	Color	Notes
GLOZO DSO W/W	36218	5905339362186	max 10	biały / white	brak none
GLOZO DSO B/W	36219	5905339362193	max 10	czarny / biały black/white	brak none
GLOZO DSO G/W	36220	5905339362209	max 10	złoty / biały gold / white	brak none
GLOZO DSO SR/W	36221	5905339362216	max 10	srebrny / biały	brak none
GLOZO DSO W/B	36222	5905339362223	max 10	biały / czarny white / black	brak none
GLOZO DSO B/B	36223	5905339362230	max 10	czarny black	brak none
GLOZO DSO G/B	36224	5905339362247	max 10	złoty / czarny gold / black	brak none
GLOZO DSO SR/B	36225	5905339362254	max 10	srebrny / czarny silver / black	brak none

[VI]						IP 20		
12 AC; 12 DC; 220-240 AC		Gx5,3/GU10						5÷25
Ø75	0,5m		MR16/PAR16	CE	UK CA			

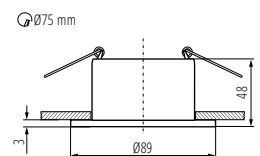

GLOZO DSO

GLOZO DSL

PIERSIEŃ OPRAWY PUNKTOWEJ ► RING FOR SPOTLIGHT FITTINGS



GLOZO DSL W/W



GLOZO DSL B/W



GLOZO DSL G/W



GLOZO DSL SR/W



GLOZO DSL B/B



GLOZO DSL G/B



GLOZO DSL SR/B



GLOZO DSL W/B



Kanlux GLOZO to duża rodzina pierścieni dekoracyjnych. Mają one modułową obudowę: podstawę w dwóch kształtach i kolorach oraz odbłyśnik w 4 kolorach w matce lub błysku. Daje nam to bardzo dużo możliwości aranżacji zestawiania ze sobą tych samych lub różnych rozwiązań kolorystycznych.

Pierścień dekoracyjny bez oprawki ceramicznej

Materiał obudowy: stop aluminium

Kanlux GLOZO is a large family of decorative rings. They have a modular housing: a base in two shapes and colors and a reflector in 4 colors in mat or mirror finish. It gives us a lot of possibilities to arrange the combination of the same or different color solutions.

Decorative ring without a ceramic frame

Enclosure material: aluminum alloy



GLOZO DSL W/W	36210	5905339362100	max 10	biały white	brak none
GLOZO DSL B/W	36211	5905339362117	max 10	czarny / biały black/white	brak none
GLOZO DSL G/W	36212	5905339362124	max 10	złoty / biały gold / white	brak none
GLOZO DSL SR/W	36213	5905339362131	max 10	srebrny / biały	brak none
GLOZO DSL W/B	36214	5905339362148	max 10	biały / czarny white / black	brak none
GLOZO DSL B/B	36215	5905339362155	max 10	czarny black	brak none
GLOZO DSL G/B	36216	5905339362162	max 10	złoty / czarny gold / black	brak none
GLOZO DSL SR/B	36217	5905339362179	max 10	srebrny / czarny silver / black	brak none

IV						IP		
12 AC; 12 DC; 220-240 AC		6x5,3/GU10				20		5+25
						CE	UK	
Ø75	0,5m							

Ø75 mm

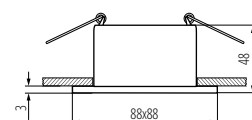

GLOZO DSL

FELINE DSO

PIERŚCIEŃ OPRAWY PUNKTOWEJ ► RING FOR SPOTLIGHT FITTINGS

NEW



FELINE DSO B/B



FELINE DSO W/B



FELINE DSO G/B



FELINE DSO B/W



FELINE DSO G/W



FELINE DSO W/W



FELINE DSO B/B	37250	5905339372505	max 10	czarny black	brak none
FELINE DSO G/B	37251	5905339372512	max 10	złoty / czarny gold / black	brak none
FELINE DSO W/B	37252	5905339372529	max 10	biały / czarny white / black	brak none
FELINE DSO W/W	37253	5905339372536	max 10	biały white	brak none
FELINE DSO G/W	37254	5905339372543	max 10	złoty / biały gold / white	brak none
FELINE DSO B/W	37255	5905339372550	max 10	czarny / biały black / white	brak none

[VI]							
12 AC; 12 DC; 220-240 AC					IP 20		5+25
					CE	UK CA	
Ø77	0,5m						

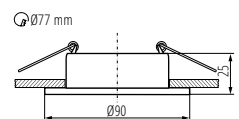

FELINE DSO



Kanlux FELINE DSO to okrągłe, eleganckie oczka sufitowe. Do dyspozycji jest 6 różnych wersji kolorystycznych, które dopasujesz do kolorystyki swojego wnętrza. Dodatkową dekoracją oczka stanowi jasny pasek (pierścień) otaczający źródło światła.

Pierścień dekoracyjny bez oprawki ceramicznej

Materiał obudowy: stop aluminium

Kanlux FELINE DSO are round, elegant ceiling eyes. There are 6 different color versions available, which you can match to the interior, where they will become a visible decoration.

Decorative ring without a ceramic frame
Enclosure material: aluminum alloy

Kanlux

FELINE DSL

PIERŚCIEŃ OPRAWY PUNKTOWEJ ► RING FOR SPOTLIGHT FITTINGS

NEW



FELINE DSL B/B



FELINE DSL W/B



FELINE DSL G/B



FELINE DSL B/W



FELINE DSL G/W



FELINE DSL W/W



FELINE DSL B/B	37256	5905339372567	max 10	czarny black	brak none
FELINE DSL G/B	37257	5905339372574	max 10	złoty / czarny gold / black	brak none
FELINE DSL W/B	37258	5905339372581	max 10	biały / czarny white / black	brak none
FELINE DSL W/W	37259	5905339372598	max 10	biały white	brak none
FELINE DSL B/W	37260	5905339372604	max 10	czarny / biały black / white	brak none
FELINE DSL G/W	37261	5905339372611	max 10	złoty / biały gold / white	brak none

IV						IP		
12 AC; 12 DC; 220-240 AC						20		5+25
Ø77	0,5m							



Kanlux FELINE DSL to kwadratowe, eleganckie oczka sufitowe. Do dyspozycji jest 6 różnych wersji kolorystycznych, które dopasujesz do wnętrza, gdzie staną się one widoczną ozdobą.

Pierścień dekoracyjny bez oprawki ceramicznej

Materiał obudowy: stop aluminium

Kanlux FELINE DSL is a square, elegant ceiling mesh. There are 6 different color versions available, which you can match to the interior, where they will become a visible decoration.

Decorative ring without a ceramic frame

Enclosure material: aluminum alloy

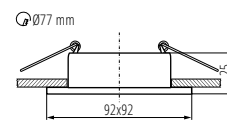

FELINE DSL

Kanlux GOVIK

PIERŚCIEŃ OPRAWY PUNKTOWEJ ► RING FOR SPOTLIGHT FITTINGS



GOVIK DSO-W



KANLUX GOVIK to oprawa do wbudowania o unikatowej konstrukcji. Zastosowanie matowego, akrylowego klosza rozprasza światło i powoduje, że zainstalowane źródło światła jest niewidoczne. Kanlux GOVIK dzięki swojej budowie wygląda jak miniatura oprawy natynkowa, a w wersji ST umieszczony jest dodatkowo pierścień świetlny, który dodaje jej nietuzinkowego charakteru.

Pierścień dekoracyjny bez oprawki ceramicznej
Materiał obudowy: stop aluminium

KANLUX GOVIK is a new holder for building in with a unique structure. The mat, acrylic lampshade diffuses light and makes the installed light source be invisible. The holder looks like a miniature integrated surface mounted luminaire.

Decorative ring without a ceramic frame
Enclosure material: aluminum alloy



GOVIK DSO-W/G	29231	5905339292315	max 10	biały / złoty white / gold	brak none
GOVIK DSO-B/G	29232	5905339292322	max 10	czarny / złoty black / gold	brak none
GOVIK-ST DSO-W/G	29233	5905339292339	max 10	biały / złoty white / gold	brak none
GOVIK-ST DSO-B/G	29234	5905339292346	max 10	czarny / złoty black / gold	brak none
GOVIK DSO-W	29235	5905339292353	max 10	biały white	brak none
GOVIK DSO-B	29236	5905339292360	max 10	czarny black	brak none
GOVIK-ST DSO-B	29237	5905339292377	max 10	czarny black	brak none
GOVIK-ST DSO-W	29238	5905339292384	max 10	biały white	brak none

[VI]					
12 AC; 12 DC; 220-240 AC					
Ø67	0,5m				

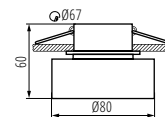

GOVIK DSO

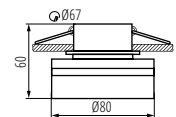

GOVIK-ST DSO

Kanlux
GOVIK

PIERŚCIEŃ OPRAWY PUNKTOWEJ ► RING FOR SPOTLIGHT FITTINGS



GOVIK DSO-W/G



GOVIK-ST DSO-W/G



GOVIK DSO-B/G



GOVIK-ST DSO-B/G



GOVIK-ST DSO-B



GOVIK-ST DSO-W



GOVIK DSO-B



CHIRO GU10

OPRAWA SUFITOWA PUNKTOWA ► CEILING-MOUNTED SPOTLIGHT FITTING



CHIRO GU10 DTO-B



CHIRO GU10 DTL-B



CHIRO GU10 DTO-W



Kanlux CHIRO GU10, to coś zupełnie nowego w kategorii oświetlenia dekoracyjnego. To oprawa typu SPOT, którą można zamontować w podwieszanym suficie tak jak zwykle oczko. Unikatowy design i montaż tej oprawy to jej największe atuty.

Materiał obudowy: stop aluminium

Kanlux CHIRO GU10, is a completely new category of decorative lighting. It is the ceiling-mounted lamp which can be mounted in a suspended ceiling just like an typical spotlight fitting. Unique design and assembly of this lamp are its largest assets.

Enclosure material: aluminum alloy



CHIRO GU10 DTO-W	29310	5905339293107	max 10	biały white	w jednej osi in one axis	90
CHIRO GU10 DTO-B	29311	5905339293114	max 10	czarny black	w jednej osi in one axis	90
CHIRO GU10 DTL-B	29313	5905339293138	max 10	czarny black	w jednej osi in one axis	90

[V] 220-240 AC	[Hz] 50	GU10	IP 20	5+25	340	Ø70
0,75-1,5	0,5m	PAR16	CE	UK CA		

Ø70

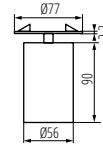

CHIRO GU10 DTO

Ø70

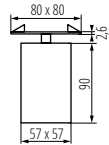

CHIRO GU10 DTL

Kanlux SPAG

PIERŚCIEŃ OPRAWY PUNKTOWEJ ► RING FOR SPOTLIGHT FITTINGS



SPAG C B-G



SPAG S B-G



SPAG D W-G



SPAG D B-G



Kanlux SPAG to eleganckie pierścienie ozdobne. Połączenie złota i klasycznej czerni lub bieli dodaje tym oprawom subtelny urok. Dzięki różnym kształtom opraw Kanlux SPAG możemy tworzyć niepowtarzalne i gustowne aranżacje oświetleniowe w naszych salonach, eleganckich restauracjach i apartamentach hotelowych.

Pierścienie dekoracyjne bez oprawki ceramicznej

Materiał obudowy: stop aluminium

Kanlux SPAG are elegant decorative rings. A combination of gold and classic black or white adds a subtle charm to these holders. Thanks to diverse shapes of the Kanlux SPAG holders, you can create unique and stylish lighting arrangements in your living rooms, elegant restaurants and hotel apartments.

Decorative ring without a ceramic frame

Enclosure material: aluminum alloy



SPAG S B/G	27322	5905339273222	max 10	czarny / złoty black/gold	brak none
SPAG C B/G	27324	5905339273246	max 10	czarny / złoty black/gold	brak none
SPAG D B/G	27326	5905339273260	max 10	czarny / złoty black/gold	brak none
SPAG D W/G	27327	5905339273277	max 10	biały / złoty white / gold	brak none

[V] 12 AC; 12 DC; 220-240 AC	6x5,3/GU10	IP 20	5+25
Ø61-62	0,5m	MR16/PAR16	CE

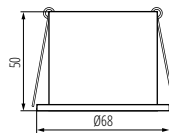

SPAG D

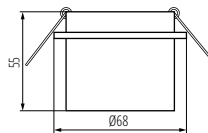

SPAG S

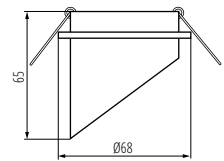

SPAG C

Kanlux MINI RITI

OPRAWA SUFITOWA PUNKTOWA ► CEILING-MOUNTED SPOTLIGHT FITTING



MINI RITI GU10 W/G



MINI RITI GU10 B/G



MINI RITI GU10 B/W



MINI RITI GU10 B/B



MINI RITI GU10 W/W



MINI RITI GU10 B/G	27575	5905339275752	max 10	czarny / złoty black / gold	brak none
MINI RITI GU10 W/G	27576	5905339275769	max 10	biały / złoty white / gold	brak none
MINI RITI GU10 B/W	27577	5905339275776	max 10	czarny / biały black / white	brak none
MINI RITI GU10 B/B	27578	5905339275783	max 10	czarny black	brak none
MINI RITI GU10 W/W	27579	5905339275790	max 10	biały white	brak none

[V] 220-240 AC	[Hz] 50	GU10	IP 20	5+25	[mm] Ø68*71
1+2,5	0,5m	PAR16	CE	UKCA	

MODERN
design

HIGH
quality
finish

Kanlux MINI RITI to mniejsza, nieco niższa wersja popularnej oprawy Kanlux RITI. Kanlux MINI RITI to oprawa wykonana z aluminium. Jej piaskowana struktura obudowy jest dodatkowo pokryta matowym lakierem w eleganckiej czerni lub bieli. Oprawę Kanlux MINI RITI cechuje dobra jakość wykonania i nowoczesne wzornictwo. Z powodzeniem możemy zastosować ją jako oświetlenie samodzielne lub zestawiać ze sobą kilka opraw. Odkręcany korpus zapewnia łatwą wymianę źródła światła. Do wyboru mamy kolor odbłyśnika: złoto-miedziany z błyszczącym pigmentem, biały lub czarny. Oprawa Kanlux MINI RITI przystosowana jest do montażu podtynkowego.

Materiał obudowy: stop aluminium

Kanlux MINI RITI is a smaller, slightly lower version of the popular Kanlux RITI luminaire. We prepared it in two versions - black and white, but each of them has several reflector colours - white, black or gold. We are sure that such a wide choice ensures that Kanlux MINI RITI can more easily be adapted to the type of interior in which it is placed. If you want to go for extravagance, you can combine different colours of the luminaires or combine them with Kanlux RITI. Together, they will create a harmonious yet unusual room luminaire.

Enclosure material: aluminum alloy

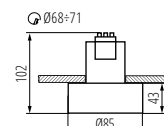

MINI RITI GU10

Kanlux MINI GORD

PIERŚCIEŃ OPRAWY PUNKTOWEJ ► RING FOR SPOTLIGHT FITTINGS



MINI GORD DLP-50-W



MINI GORD DLP-50-B



MINI GORD DLP-50-W	28780	5905339287809	max 10	biały white	w jednej osi in one axis	30
MINI GORD DLP-50-B	28781	5905339287816	max 10	czarny black	w jednej osi in one axis	30

[V] 12 AC; 12 DC; 220-240 AC	6x5,3/GU10	IP 20	5+25	Ø85	0,5m	MR16/PAR16	CE	UKCA	
---------------------------------	------------	----------	------	-----	------	------------	----	------	--

MODERN
design

MODERN
design

Mini wersja opraw Kanlux GORD. Doskonała alternatywa dla osób, które chcą stosować oprawy natynkowe na suficie podwieszanym, ponieważ sposób ich montażu jest taki sam jak w przypadku opraw wpuszczanych typu oczko. Dodatkowym atutem jest regulacja kątowa opraw MINI GORD w zakresie 30°.

Pierścień dekoracyjny bez oprawy ceramicznej

Materiał obudowy: stop aluminium, stal

The Mini version of the GORD fixtures. A perfect alternative for people who want to use surface-mounted fixtures in a suspended ceiling, because the manner of installation is the same as for recessed-eyelet fixtures. An additional advantage is the angular adjustment of the MINI GORD fixtures within the range of 30°.

Decorative ring without a ceramic frame

Enclosure material: aluminum alloy, steel

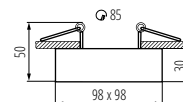

MINI GORD DLP-50

Kanlux

MINI BORD

PIERŚCIEŃ OPRAWY PUNKTOWEJ ► RING FOR SPOTLIGHT FITTINGS



MINI BORD DLP-50-W



MINI BORD DLP-50-B



Mini wersja popularnych opraw Kanlux BORD. Jest to doskonała alternatywa dla osób, które chcą stosować oprawy natynkowe w suficie podwieszanym. Sposób ich montażu jest taki sam jak w przypadku opraw wpuszczanych typu oczko, a wyglądem przywodzą na myśl oprawy natynkowe. Dodatkowym atutem jest regulacja kątowa opraw MINI BORD w zakresie 30°.

Pierścień dekoracyjny bez oprawki ceramicznej

Materiał obudowy: stop aluminium, stal

The Mini version of the BORD fixtures. A perfect alternative for people who want to use surface-mounted fixtures in a suspended ceiling, because the manner of installation is the same as for recessed-eyelet fixtures. An additional advantage is the angular adjustment of the MINI BORD fixtures within the range of 30°.

Decorative ring without a ceramic frame

Enclosure material: aluminum alloy, steel



MINI BORD DLP-50-W	28782	5905339287823	max 10	biały white	w jednej osi in one axis	30
MINI BORD DLP-50-B	28783	5905339287830	max 10	czarny black	w jednej osi in one axis	30

[V] 12 AC; 12 DC; 220-240 AC		 Gx5,3/GU10		 IP 20		 5+25
 Ø85	 0,5m	 MR16/PAR16				

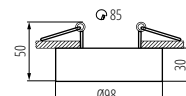

MINI BORD DLP-50

Kanlux

TINY BORD

PIERŚCIEŃ OPRAWY PUNKTOWEJ ► RING FOR SPOTLIGHT FITTINGS



TINY BORD DTO-B



TINY BORD DTO-B/G



TINY BORD DTO-W



TINY BORD DTO-W/G



Kanlux TINY BORD to mini wersja popularnych opraw natynkowych Kanlux MINI BORD. Podobnie jak rodzina Kanlux MINI BORD, KANLUX TINY BORD jest pierścieniem dekoracyjnym, montowanym podtynkowo. Kanlux TINY BORD gwarantują wyjątkowe oświetlenie umożliwiające podkreślenie wybranych elementów wystroju pomieszczenia i stworzenie przyjemnego nastroju. Nowoczesny i prosty design sprawia, że pierścienie pasują zarówno do wnętrz mieszkalnych jak i komercyjnych. Do wyboru mamy kilka zestawień kolorystycznych, spośród których każdy wybierze coś dla siebie.

Materiał obudowy: stop aluminium

Kanlux TINY BORD is a mini version of the popular Kanlux MINI BORD surface-mounted fixtures. Like the Kanlux MINI BORD family, Kanlux TINY BORD is a decorative ring, flush-mounted. Kanlux TINY BORD guarantee unique lighting that allows you to highlight selected elements of the room's design and create a pleasant atmosphere. The modern and simple design makes the rings suitable for both residential and commercial interiors. We have several color combinations to choose from, the models with a gold ring deserve special attention.

Enclosure material: aluminum alloy



TINY BORD DTO-B	37165	5905339371652	max 10	czarny black	w jednej osi in one axis	30
TINY BORD DTO-B/G	37166	5905339371669	max 10	czarny / złoty black / gold	w jednej osi in one axis	30
TINY BORD DTO-W	37167	5905339371676	max 10	biały white	w jednej osi in one axis	30
TINY BORD DTO-W/G	37168	5905339371683	max 10	biały / złoty white / gold	w jednej osi in one axis	30

[V] 12 AC; 12 DC; 220-240 AC		 Gx5,3/GU10		 IP 20		
 5+25	 Ø85	 0,5m	 MR16/PAR16			

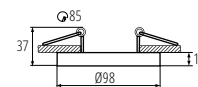

TINY BORD DTO

Kanlux AGEO

PIERŚCIEŃ OPRAWY PUNKTOWEJ

► RING FOR SPOTLIGHT FITTINGS



AGEO DSO-W



AGEO DSO-B	33165	5905339331656	max 10	czarny black	w jednej osi in one axis	20
AGEO DSO-W	33166	5905339331663	max 10	biały white	w jednej osi in one axis	20

[V] 12 AC; 12 DC; 220-240 AC		 Gx5,3/GU10			IP 20		 5+25
 Ø95	 0,5m	 MR16/PAR16					



AGEO DSO-B



Kanlux AGEO to niebanalny pierścień dekoracyjny, który stanie się ozdobą dla każdego pomieszczenia. Źródło światła jest całkowicie schowane w regulowanym, wystającym z pierścienia kloszu, co zapewnia ciekawy efekt świetlny. Kanlux AGEO to możliwość swobodnej regulacji kierunku padania światła w zakresie 20 stopni. Pierścień dekoracyjny sprzedawany jest bez oprawki - sami zdecydujemy o dopasowaniu źródła światła o trzonku Gx5,3 lub GU10.

Pierścień dekoracyjny bez oprawki ceramicznej
Materiał obudowy: stop aluminium

Kanlux AGEO is an original decorative ring that will become a decoration for any room. The light source is completely hidden in an adjustable, extending from the ring shade, which provides an interesting light effect. Kanlux AGEO is the ability to adjust the direction of light in the range of 20 degrees. The decorative ring is sold without a lamp holder - you decide which light source to use (the Gx5.3 or GU10 cap).

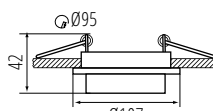

AGEO DSO

couldn't connect to host

Kanlux IMINES

PIERŚCIEŃ OPRAWY PUNKTOWEJ

► RING FOR SPOTLIGHT FITTINGS



IMINES DSO-W



IMINES DSO-W	29031	5905339290311	max 10	biały mat matte white	brak none	
--------------	--------------	---------------	--------	-------------------------	-------------	--

[V] 12 AC; 12 DC; 220-240 AC		 Gx5,3/GU10			IP 20		 5+25
 Ø95	 0,5m	 MR16/PAR16					



Kanlux IMINES to unikatowa oprawa, która posiada zaskakujący efekt świetlny - po włączeniu światła uzyskujemy dodatkowy, ozdobny pierścień świetlny.

Pierścień dekoracyjny bez oprawki ceramicznej
Materiał obudowy: stop aluminium, tworzywo sztuczne

Kanlux IMINES is a unique fixture, which has a surprising light effect - when you turn on the light, you get an additional, decorative light ring.

Decorative ring without a ceramic frame
Enclosure material: aluminum alloy, plastic

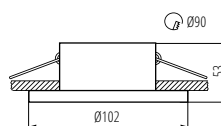

IMINES DSO

Kanlux APRILA

PIERŚCIEŃ OPRAWY PUNKTOWEJ

► RING FOR SPOTLIGHT FITTINGS



APRILA DTO-W



APRILA DTO-W	26738	5905339267382	max 10	biały mat matte white	w jednej osi in one axis	20
--------------	--------------	---------------	--------	-------------------------	----------------------------	----

[V] 12 AC; 12 DC; 220-240 AC		 Gx5,3/GU10			IP 20		 5+25
 Ø90	 0,5m	 MR16/PAR16					



Kanlux APRILA to biały pierścień dekoracyjny wykonanych z aluminium. Kanlux APRILA ma opływowy kształt i możliwość regulacji kąta padania światła w zakresie 20 stopni. Możemy zastosować tu oprawkę GU10 lub Gx5,3, co pozwoli nam na dobranie źródeł światła dopasowanych do przygotowanej instalacji.

Pierścień dekoracyjny bez oprawki ceramicznej
Materiał obudowy: stop aluminium

Kanlux APRILA is a family of white decorative rings made of aluminium. Kanlux APRILA has a streamlined shape and can be adjusted in terms of the angle of light within the range of 20 degrees. The JDR or MR-16 frame can be used for the holders, which will allow us to use light sources adapted to a prepared installation.

Decorative ring without a ceramic frame
Enclosure material: aluminum alloy

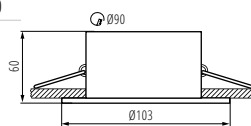

APRILA DTO

Kanlux SEIDY

OPRAWA SUFITOWA PUNKTOWA ► CEILING-MOUNTED SPOTLIGHT FITTING



SEIDY CT-DT050-B/M



Kanlux SEIDY to popularna rodzina opraw oczek sufitowych, w której możemy wybrać oprawy z 1 lub 2 punktami świetlnymi. Dzięki szerokiemu wyborowi kolorów i faktur materiałów, z których są wykonane, skomponujemy z nich idealne oświetlenie kawiarni, wnętrz hotelowych, ale także zacisza domowego.

Materiał obudowy: stop aluminium

Kanlux SEIDY is a popular family of holders in which you can choose from 1 to 4 light points. You will compose ideal lighting of coffee shops, hotel interiors and privacy interiors of them.

Enclosure material: aluminium alloy



SEIDY CT-DT050-AL	18280	5905339182807	max 10	aluminium szczotkowane brushed aluminium	w jednej osi in one axis	30
SEIDY CT-DTL50-AL	18281	5905339182814	max 10	aluminium szczotkowane brushed aluminium	w jednej osi in one axis	30
SEIDY CT-DT050-B	18288	5905339182883	max 10	czarny anodowany black anodised	w jednej osi in one axis	30
SEIDY CT-DTL50-B	18289	5905339182890	max 10	czarny anodowany black anodised	w jednej osi in one axis	30
SEIDY CT-DTL50-W/M	19454	5905339194541	max 10	biały mat matte white	w jednej osi in one axis	30
SEIDY CT-DTL250-W/M	19455	5905339194558	2 x max 10	biały mat matte white	w jednej osi in one axis	30
SEIDY CT-DT050-W/M	19456	5905339194565	max 10	biały mat matte white	w jednej osi in one axis	30
SEIDY CT-DT050-B/M	19457	5905339194572	max 10	czarny mat black matt	w jednej osi in one axis	30
SEIDY CT-DTL50-B/M	19458	5905339194589	max 10	czarny mat black matt	w jednej osi in one axis	30
SEIDY CT-DTL250-B/M	19459	5905339194596	2 x max 10	czarny mat black matt	w jednej osi in one axis	30

12 AC; 12 DC	Gx5,3	III	4	IP 20	5+25	5+25	0,12
0,75	0,5m	MR-16					

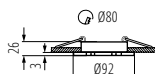

SEIDY CT-DT050

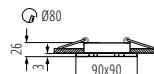

SEIDY CT-DTL50

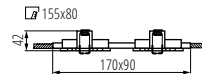

SEIDY CT-DTL250

Kanlux
SEIDY

OPRAWA SUFITOWA PUNKTOWA ▶ CEILING-MOUNTED SPOTLIGHT FITTING



SEIDY CT-DT050-AL



SEIDY CT-DT050-B



SEIDY CT-DT050-W/M



SEIDY CT-DTL50-AL



SEIDY CT-DTL50-B



SEIDY CT-DTL50-W/M



SEIDY CT-DTL50-B/M



SEIDY CT-DTL250-B/M



SEIDY CT-DTL250-W/M



SIMEN DSO

PIERŚCIEŃ OPRAWY PUNKTOWEJ ► RING FOR SPOTLIGHT FITTINGS



SIMEN DSO B/G



SIMEN DSO B/G	29137	5905339291370	max 10	czarny / złoty black / gold	brak none
SIMEN DSO B/W	29138	5905339291387	max 10	czarny / biały black / white	brak none
SIMEN DSO W/B	29139	5905339291394	max 10	biały / czarny white / black	brak none
SIMEN DSO W/G	29140	5905339291400	max 10	biały / złoty white / gold	brak none
SIMEN DSO G/W	29142	5905339291424	max 10	złoty / biały gold / white	brak none

12 AC; 12 DC; 220-240 AC	Gx5,3/GU10	MR16/PAR16	IP 20	5+25	Ø68	0,5m



SIMEN DSO B/W



SIMEN DSO W/G



SIMEN DSO G/W



SIMEN DSO W/B



Kanlux SIMEN DSO to oprawa, która składa się z dwóch części: pierścienia i korpusu. Proponujemy stałe zestawy kolorystyczne, klasyczną czern i biel lub oprawy zawierające srebrne i złote elementy, które dopasujesz do wnętrza, gdzie staną się one widoczną ozdobą. Możesz również samodzielnie wymieniać elementy z posiadanych zestawów opraw Kanlux SIMEN DSO.

Pierścień dekoracyjny bez oprawki ceramicznej
Materiał obudowy: stop aluminium

Kanlux SIMEN DSO is a fixture which consists of two parts - ring, and body. Our range includes permanent colour sets in classic black and white, and fixtures with silver and gold elements, which will fit in with your interior, where they will become a visible decoration. You can also replace individual elements with other Kanlux SIMEN DSO fixture sets you already have.

Decorative ring without a ceramic frame
Enclosure material: aluminum alloy

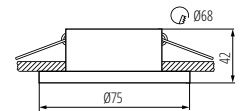

SIMEN DSO

SIMEN DSL

PIERŚCIEŃ OPRAWY PUNKTOWEJ ► RING FOR SPOTLIGHT FITTINGS



SIMEN DSL SR/B/B



SIMEN DSL B/W/B	29131	5905339291318	max 10	czarny / biały / czarny black / white / black	brak none
SIMEN DSL SR/B/B	29132	5905339291325	max 10	srebrny / czarny / czarny silver / black / black	brak none
SIMEN DSL B/G/B	29134	5905339291349	max 10	czarny / złoty / czarny black / gold / black	brak none
SIMEN DSL W/G/W	29135	5905339291356	max 10	biały / złoty / biały white / gold / white	brak none

12 AC; 12 DC; 220-240 AC	Gx5,3/GU10	MR16/PAR16	IP 20	5+25	Ø68	0,5m



SIMEN DSL B/G/B



SIMEN DSL W/G/W



SIMEN DSL B/W/B



Kanlux SIMEN DSL to oprawa, która składa się z trzech części: pierścienia, korpusu i podstawy. Proponujemy gotowe zestawy kolorystyczne: klasyczną czern i biel lub oprawy zawierające srebrne i złote elementy, które dopasujesz do wnętrza, gdzie staną się one widoczną ozdobą. Możesz również samodzielnie wymieniać elementy z posiadanych zestawów opraw Kanlux SIMEN DSL.

Pierścień dekoracyjny bez oprawki ceramicznej
Materiał obudowy: stop aluminium

Kanlux SIMEN DSL is a fixture which consists of three parts - ring, body and base. Our range includes prepared colour sets in classic black and white, or fixtures with silver and gold elements, which will fit in with your interior, where they will become a visible decoration. You can also replace individual elements with other Kanlux SIMEN DSL fixture sets you already have.

Decorative ring without a ceramic frame
Enclosure material: aluminum alloy

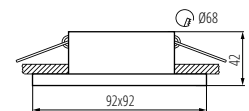

SIMEN DSL

Kanlux ALOR

PIERŚCIEŃ OPRAWY PUNKTOWEJ ► RING FOR SPOTLIGHT FITTINGS



ALOR DSL-W

NEW



ALOR DSL-B



ALOR DTL-W

NEW



ALOR DTL-B



ALOR DSO-W

NEW



ALOR DSO-B



ALOR DTO-W

NEW



ALOR DTO-B

Kanlux ALOR to rodzina oczek w najbardziej popularnych kolorach; czarnym i białym, o matowym wykończeniu. Oczka nie posiadają w komplecie oprawki ceramicznej. Możemy tu zastosować oprawkę, która będzie pasować do trzonka GU10 lub Gx5,3, co pozwoli nam na zastosowanie źródeł światła dopasowanych do przygotowanej instalacji.

Pierścienie dekoracyjny bez oprawki ceramicznej

Materiał obudowy: stal

Kanlux ALOR is a family of downlights in the most popular colors; black and white, with a matte finish. Downlight do not have a ceramic lamp holder in the set. We can use the lamp holder that will fit the GU10 or Gx5.3 base, which will allow us to use light sources adapted to the prepared installation.

Decorative ring without a ceramic frame
Enclosure material: steel



NEW	Model	Code	Power	Color	Finish	Beam Angle
NEW	ALOR DSL-W	26726	5905339267269	max 10	biały mat matte white	brak none
NEW	ALOR DSL-B	26727	5905339267276	max 10	czarny mat black matt	brak none
NEW	ALOR DTL-W	26731	5905339267313	max 10	biały mat matte white	w jednej osi in one axis 30
NEW	ALOR DTL-B	26732	5905339267320	max 10	czarny mat black matt	w jednej osi in one axis 30
NEW	ALOR DSO-W	26790	5905339267900	max 10	biały mat matte white	brak none
NEW	ALOR DSO-B	26791	5905339267917	max 10	czarny mat black matt	brak none
NEW	ALOR DTO-W	26795	5905339267955	max 10	biały mat matte white	w jednej osi in one axis 30
NEW	ALOR DTO-B	26796	5905339267962	max 10	czarny mat black matt	w jednej osi in one axis 30

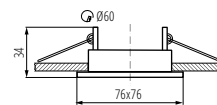

ALOR DSL

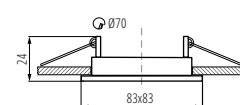

ALOR DTL

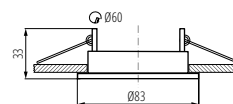

ALOR DSO

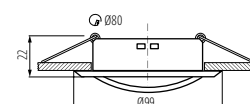

ALOR DTO

12 AC; 12 DC; 220-240 AC	IP 20	MR16/PAR16	CE	UK CA
5+25	0,5m			

Kanlux ELNIS S

PIERŚCIEŃ OPRAWY PUNKTOWEJ ► RING FOR SPOTLIGHT FITTINGS



ELNIS S W



ELNIS S W | **27800** | 5905339278005 | max 10 | biały | white | brak | none

[V] 12 AC; 12 DC; 220-240 AC							
 Ø70	 0,5m						



Kanlux ELNIS to oprawa, która składa się z dwóch części tworzących całość. To kombinacja dwóch odrębnych elementów: korpusu (zasadniczej części) oraz obudowy (pierścienia dystansowego), tworzących idealnie dopasowaną całość. Wysokość obudowy ELNIS S wynosi 10 mm. Kanlux ELNIS cechuje nowoczesny wygląd i bardzo wysoka jakość wykonania.

Pierścień dekoracyjny bez oprawki ceramicznej
Materiał obudowy: stop aluminium

The Kanlux ELNIS is a fixture which consists of two parts forming a whole. It is a combination of two separate elements: the body (the main part) and the casing (the spacer ring), forming a perfectly matched whole. ELNIS S is a fixture with a 10-mm-high casing. The Kanlux ELNIS is characterised by modern design and very-high quality of workmanship.

Decorative ring without a ceramic frame
Enclosure material: aluminum alloy

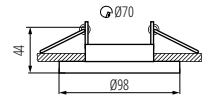

ELNIS S

Kanlux ELNIS L

PIERŚCIEŃ OPRAWY PUNKTOWEJ ► RING FOR SPOTLIGHT FITTINGS



ELNIS L W/A

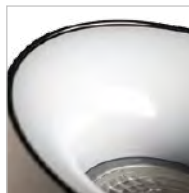

Kanlux ELNIS L to oprawa, która składa się z dwóch części tworzących całość. To kombinacja dwóch odrębnych elementów: korpusu (zasadniczej części) oraz obudowy (pierścienia dystansowego), tworzących idealnie dopasowaną całość. Wysokość obudowy ELNIS L wynosi 25 mm. Kanlux ELNIS L cechuje nowoczesny wygląd i bardzo wysoka jakość wykonania.

Pierścień dekoracyjny bez oprawki ceramicznej
Materiał obudowy: stop aluminium

The Kanlux ELNIS L is a fixture which consists of two parts forming a whole. It is a combination of two separate elements: the body (the main part) and the casing (the spacer ring), forming a perfectly matched whole. The ELNIS L is a fixture with a 25-mm-high casing. The Kanlux ELNIS L is characterised by modern design and very-high quality of workmanship.

Decorative ring without a ceramic frame
Enclosure material: aluminum alloy



ELNIS L W



ELNIS L W/C



ELNIS L A/C



ELNIS L A



ELNIS L B/G



ELNIS L W	27804	5905339278043	max 10	biały white	brak none
ELNIS L W/A	27805	5905339278050	max 10	biały / antracyt white / anthracite	brak none
ELNIS L W/C	27806	5905339278067	max 10	biały / chrom white / chrome	brak none
ELNIS L A/C	27808	5905339278081	max 10	antracyt / chrom anthracite / chrome	brak none
ELNIS L A	27809	5905339278098	max 10	antracyt anthracite	brak none
ELNIS L B/G	27810	5905339278104	max 10	czarny / złoty black/gold	brak none

[V] 12 AC; 12 DC; 220-240 AC							
 Ø70	 0,5m						

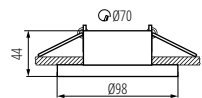

ELNIS L

Kanlux DALLA

OPRAWA SUFITOWA PUNKTOWA ► CEILING-MOUNTED SPOTLIGHT FITTING



DALLA CT-DTL50-B



DALLA CT-DT050-W



DALLA CT-DTL50-W



DALLA CT-DT050-B



Kanlux DALLA to bardzo starannie wykonana oprawa do montażu wewnątrz budynków. Posiada ruchomy pierścień przez co możemy regulować strumień światła. Jej kształty i uniwersalne kolory pozwalają na osiągnięcie nowoczesnego, dyskretnego efektu elegancji.

Materiał obudowy: stop aluminium

Kanlux DALLA is a very carefully made holder for installation inside buildings. It has a movable ring, thanks to which you can adjust the light stream. Its shapes and universal colours allow achieving a modern, discrete effect of elegance.

Enclosure material: aluminum alloy



DALLA CT-DT050-W	22430	5905339224309	max 10	biały white	w jednej osi in one axis	30
DALLA CT-DTL50-W	22431	5905339224316	max 10	biały white	w jednej osi in one axis	30
DALLA CT-DT050-B	22432	5905339224323	max 10	czarny black	w jednej osi in one axis	30
DALLA CT-DTL50-B	22433	5905339224330	max 10	czarny black	w jednej osi in one axis	30

[V] 12 AC; 12 DC	Gx5,3	III	↑	IP 20	5+25	070	0,12	0,75	0,5m	MR-16	CE	EAC	UK CA
[m]	[mm]	[mm]	[mm]	[mm]	[mm]	[mm]	[mm]	[mm]	[mm]	[mm]	[mm]	[mm]	[mm]

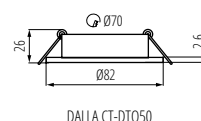

DALLA CT-DT050

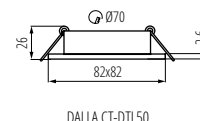

DALLA CT-DTL50

Kanlux SOREN

OPRAWA SUFITOWA PUNKTOWA ► CEILING-MOUNTED SPOTLIGHT FITTING



SOREN O



SOREN L



SOREN O-SR.VVW	24410	5905339244109	max 20	srebrny silver	brak none
SOREN O-BL	24411	5905339244116	max 20	srebrny silver	brak none
SOREN L-SR.VVW	24413	5905339244130	max 20	srebrny silver	brak none
SOREN L-BL	24414	5905339244147	max 20	srebrny silver	brak none
SOREN O-SR.CW	24416	5905339244161	max 20	srebrny silver	brak none
SOREN L-SR.CW	24417	5905339244178	max 20	srebrny silver	brak none

[V] 220-240 AC	[Hz] 50	[W]/LED 3,6	PAR16	GU10	SMD	≥15000	20000	IP 20	5+25	0,75+2,5	0,5m	CE	EAC	UK CA
[mm]	[mm]	[mm]	[mm]	[mm]	[mm]	[mm]	[mm]	[mm]	[mm]	[mm]	[mm]	[mm]	[mm]	[mm]

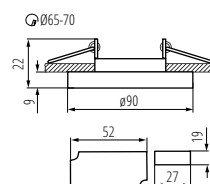

SOREN O

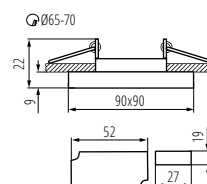

SOREN L



Kanlux SOREN to szklane oprawy, których dodatkowym atutem jest kolorowy, dekoracyjny pasek LED rozświetlający szklaną podstawę oprawy.

Materiał obudowy: szkło

Kanlux SOREN are glass holders whose additional asset is the colourful, decorative LED strip lighting up the glass base of the holder.

Enclosure material: glass

Kanlux ELICEO

PIERŚCIEŃ OPRAWY PUNKTOWEJ ▶ RING FOR SPOTLIGHT FITTINGS



NEW

ELICEO DSO B



ELICEO DSO W/W



ELICEO DSO W/G



ELICEO DSO B/B



ELICEO-ST DSO W/W



ELICEO-ST DSO W/G



ELICEO-ST DSO B/B



ELICEO-ST DSO W

NEW



ELICEO-ST DSO YG

NEW



ELICEO-ST DSO GR

NEW



ELICEO-ST DSO PK

NEW



ELICEO-ST DSO BL

NEW



Kanlux ELICEO to pierścienie ozdobne (oczka) z nietypowym efektem świecenia. Oprócz głównego źródła światła posiadają także dwa świecące pierścienie w obudowie, co daje niepowtarzalny efekt dekoracyjny. Dostępne są w siedmiu wersjach kolorystycznych. Do pierścieni sam dobierzesz oprawkę, co pozwoli Ci dostosować Kanlux ELICEO do Twojej instalacji (12V lub 230V).

Pierścieni dekoracyjny bez oprawki ceramicznej
Materiał obudowy: stop aluminium

Kanlux ELICEO are decorative rings (fixed downlights) with an unusual lighting effect. In addition to the main light source, they also have two luminous rings in the housing, which gives a unique decorative effect. They are available in seven colour versions. You can choose your own luminaire for the rings, which will allow you to adapt Kanlux ELICEO to your installation (12V or 230V).

Decorative ring without a ceramic frame
Enclosure material: aluminum alloy



ELICEO DSO B/B	35280	5905339352804	max 10	czarny black	brak none
ELICEO DSO W/W	35281	5905339352811	max 10	biały white	brak none
ELICEO DSO W/G	35283	5905339352835	max 10	biały / złoty white / gold	brak none
ELICEO-ST DSO B/B	35284	5905339352842	max 10	czarny black	brak none
ELICEO-ST DSO W/W	35285	5905339352859	max 10	biały white	brak none
ELICEO-ST DSO W/G	35287	5905339352873	max 10	biały / złoty white / gold	brak none
ELICEO DSO W	35288	5905339352880	max 10	biały white	brak none
ELICEO DSO B	35289	5905339352897	max 10	czarny black	brak none
ELICEO DSO YG	35295	5905339352958	max 10	złoty gold	brak none
ELICEO DSO GR	35296	5905339352965	max 10	zielony green	brak none
ELICEO DSO PK	35297	5905339352972	max 10	różowy pink	brak none
ELICEO DSO BL	35298	5905339352989	max 10	niebieski blue	brak none

12 AC; 12 DC; 220-240 AC	IP 20	5+25
Ø68	0,5m	MR16/PAR16
CE	UK CA	

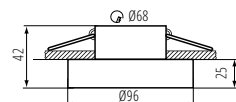

ELICEO DSO

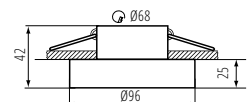

ELICEO-ST DSO

Kanlux MORTA

OPRAWA SUFITOWA PUNKTOWA ► CEILING-MOUNTED SPOTLIGHT FITTING



MORTA CT-DLSL50-B



MORTA CT-DSL50-SR



MORTA CT-DSO50-B



MORTA CT-DSO50-SR

DESIGN
unique

Szeroka gama modeli opraw Kanlux MORTA pozwoli na zrealizowanie bardzo oryginalnych aranżacji w każdym domu. Kanlux MORTA spełnią oczekiwania wszystkich, którzy cenią sobie produkty wysokiej jakości, charakteryzujące się atrakcyjnym i oryginalnym designem.

Materiał obudowy: szkło

A wide range of the Kanlux MORTA holder models will allow making very original arrangements in each house. Kanlux MORTA meet expectations of everyone that highly values products of high quality, characterized by attractive and original design.

Enclosure material: glass



MORTA CT-DLSL50-B	18510	5905339185105	max 10	czarny black	brak none
MORTA CT-DSL50-SR	18512	5905339185129	max 10	srebrny silver	brak none
MORTA CT-DSO50-B	19440	5905339194404	max 10	czarny black	brak none
MORTA CT-DSO50-SR	19442	5905339194428	max 10	srebrny silver	brak none

12 AC; 12 DC	Gx5,3	III	15°	IP 20		5÷25		0,12
0,75	0,5m	MR-16						

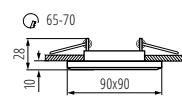

MORTA CT-DSL50

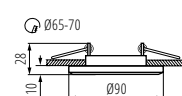

MORTA CT-DSO50

Kanlux MORTA DT

PIERŚCIEŃ OPRAWY PUNKTOWEJ ► RING FOR SPOTLIGHT FITTINGS



MORTA CT-DTL50-B



MORTA CT-DTO50-SR



MORTA CT-DTO50-B



MORTA CT-DTL50-SR

DESIGN
unique

Szeroka gama modeli opraw Kanlux MORTA pozwoli na zrealizowanie bardzo oryginalnych aranżacji w każdym domu. Kanlux MORTA spełnią oczekiwania wszystkich, którzy cenią sobie produkty wysokiej jakości, charakteryzujące się atrakcyjnym i oryginalnym designem.

Pierścien dekoracyjny bez oprawki ceramicznej

Materiał obudowy: szkło

A wide range of the Kanlux MORTA holder models will allow making very original arrangements in each house. Kanlux MORTA meet expectations of everyone that highly values products of high quality, characterized by attractive and original design.

Decorative ring without a ceramic frame

Enclosure material: glass



MORTA CT-DTO50-SR	26716	5905339267160	max 10	srebrny silver	w jednej osi in one axis	30
MORTA CT-DTO50-B	26717	5905339267177	max 10	czarny black	w jednej osi in one axis	30
MORTA CT-DTL50-SR	26718	5905339267184	max 10	srebrny silver	w jednej osi in one axis	30
MORTA CT-DTL50-B	26719	5905339267191	max 10	czarny black	w jednej osi in one axis	30

12 AC; 12 DC; 220-240 AC	Gx5,3/GU10	III	15°	IP 20		5÷25		
Ø75-80	0,5m	MR16/PAR16						

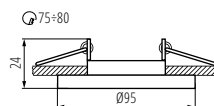

MORTA CT-DTO50-SR

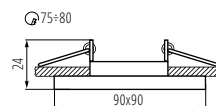

MORTA CT-DTL50

MORTA OCT

PIERŚCIEŃ OPRAWY PUNKTOWEJ ► RING FOR SPOTLIGHT FITTINGS



MORTA OCT-SR



MORTA OCT-B



MORTA OCT-SR	26714	5905339267146	max 10	srebrny silver	brak none
MORTA OCT-B	26715	5905339267153	max 10	czarny black	brak none

[V]						
12 AC; 12 DC; 220-240 AC						5+25
(mm) Ø60-65	0,5m					

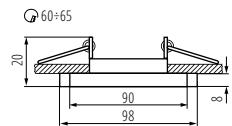

MORTA OCT

MORTA B

OPRAWA SUFITOWA PUNKTOWA ► CEILING-MOUNTED SPOTLIGHT FITTING



MORTA B CT-DSL50-B



MORTA B CT-DSL50-SR



MORTA B CT-DSO50-B



MORTA B CT-DSO50-SR



MORTA B CT-DSL50-B	22110	5905339221100	max 10	czarny black	brak none
MORTA B CT-DSL50-SR	22112	5905339221124	max 10	srebrny silver	brak none
MORTA B CT-DSO50-B	22116	5905339221162	max 10	czarny black	brak none
MORTA B CT-DSO50-SR	22117	5905339221179	max 10	srebrny silver	brak none

[V]							
12 AC; 12 DC							
(m)	(mm)	0,5m					
0,12	0,75						

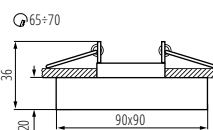

MORTA B CT-DSL50

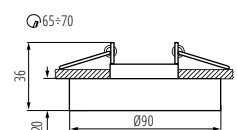

MORTA B CT-DSO50



Szeroka gama modeli opraw Kanlux MORTA pozwoli na zrealizowanie bardzo oryginalnych aranżacji w każdym domu. Kanlux MORTA spełnią oczekiwania wszystkich, którzy cenią sobie produkty wysokiej jakości, charakteryzujące się atrakcyjnym i oryginalnym designem.

Pierścień dekoracyjny bez oprawki ceramicznej

Materiał obudowy: szkło

A wide range of the Kanlux MORTA holder models will allow making very original arrangements in each house. Kanlux MORTA meet expectations of everyone that highly values products of high quality, characterized by attractive and original design.

Decorative ring without a ceramic frame

Enclosure material: glass



Szeroka gama modeli opraw Kanlux MORTA pozwoli na zrealizowanie bardzo oryginalnych aranżacji w każdym domu. Kanlux MORTA spełnią oczekiwania wszystkich, którzy cenią sobie produkty wysokiej jakości, charakteryzujące się atrakcyjnym i oryginalnym designem.

Materiał obudowy: szkło

A wide range of the Kanlux MORTA holder models will allow making very original arrangements in each house. Kanlux MORTA meet expectations of everyone that highly values products of high quality, characterized by attractive and original design.

Enclosure material: glass

Kanlux IVRI

PIERŚCIEŃ OPRAWY PUNKTOWEJ ► RING FOR SPOTLIGHT FITTINGS



IVRI DTO-W



IVRI DTO-W | **26736** | 5905339267368 | max 10 | biały | white | w jednej osi | in one axis | 30

IVRI					IP 20		
12 AC; 12 DC; 220-240 AC		Gx5.3/GU10			IP 20		5+25
					CE	UK CA	
Ø83	0,5m		MR16/PAR16				

Kanlux IVRI to pierścień dekoracyjny wykonany z aluminium. Kanlux IVRI jest wyrazisty w swoim kształcie, a regulacja kierunku świecenia źródła światła wynosi 30 stopni.

Pierścień dekoracyjny bez oprawki ceramicznej
Materiał obudowy: stop aluminium

Kanlux IVRI is a decorative ring made of aluminium. Kanlux IVRI is expressive in its shape and adjustment of the direction of light - light source comes to 30 degrees.

Decorative ring without a ceramic frame
Enclosure material: aluminum alloy

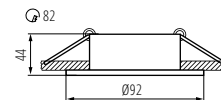

IVRI DTO

Kanlux ARET

PIERŚCIEŃ OPRAWY PUNKTOWEJ ► RING FOR SPOTLIGHT FITTINGS



ARET 1xMR16-W



ARET 2xMR16-W



Rodzina opraw Kanlux ARET to pierścienie ozdobne wykonane ze stopu aluminium oraz blachy stalowej. Oczka te są bez oprawki - sami decydujemy czy dodamy do niego oprawkę GZ10 czy GX5.3. Pozwala nam to dopasować źródła światła do instalacji, którą mamy w danym pomieszczeniu. Kanlux ARET sprawdzą się jako oświetlenie pomocnicze, zarówno w domach, barach jak i w restauracjach, wszędzie tam gdzie chcemy zaakcentować ciekawą aranżację pomieszczenia lub wyeksponować jego fragment.

Pierścień dekoracyjny bez oprawki ceramicznej
Materiał obudowy: stop aluminium

A family of the Kanlux ARET holders are decorative rings made of aluminium alloy and steel metal sheet. These eyes are without a frame - you decide on your own whether to add the GZ10 or GX5.3 frame to it. It allows adapting the light source to an installation available in a given room. Kanlux ARET works well as additional lighting both at homes, in bars and in restaurants, in places where you want to emphasize an interesting arrangement of a room or to display its fragment.

Decorative ring without a ceramic frame
Enclosure material: aluminum alloy



ARET 1xMR16-W | **26720** | 5905339267207 | max 10 | biały | white | w jednej osi | in one axis | 20
ARET 2xMR16-W | **26723** | 5905339267238 | 2 x max 10 | biały | white | w jednej osi | in one axis | 20

IVRI					IP 20		
12 AC; 12 DC; 220-240 AC		Gx5.3/GU10			IP 20		5+25
					CE	UK CA	
	0,5m		MR16/PAR16				

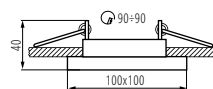

ARET 1xMR16

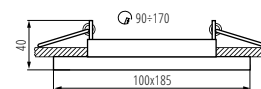

ARET 2xMR16

ALREN R

PIERŚCIEŃ OPRAWY PUNKTOWEJ ► RING FOR SPOTLIGHT FITTINGS



ALREN R DTL-W



ALREN R DTL-B



ALREN R DTL-B	26757	5905339267573	max 10	czarny black	w dwóch osiach in two axes	60/60
ALREN R DTL-W	26758	5905339267580	max 10	biały white	w dwóch osiach in two axes	60/60

[V] 12 AC; 12 DC; 220-240 AC						IP 20		 5+25
 60	 80x80	 0,5m				CE	UK CA	

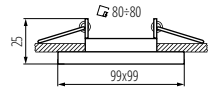

ALREN R DTL

Kanlux ALREN

PIERŚCIEŃ OPRAWY PUNKTOWEJ ► RING FOR SPOTLIGHT FITTINGS



ARLEN DTL-W



ARLEN DTL-B



ARLEN DTL-C/M



Pierścienie dekoracyjne Kanlux ALREN oferowane są bez oprawki – sami decydujemy czy dodamy do niego oprawkę GU10 czy GX5.3. Oprawy do wbudowania w sufit świetnie sprawdzają się jako oświetlenie pomocnicze w domach, barach, restauracjach, wszędzie tam gdzie chcemy zaakcentować aranżację pomieszczenia lub wyeksponować jego fragment.

Pierścień dekoracyjny bez oprawki ceramicznej
Materiał obudowy: stop aluminium

The Kanlux ALREN decorative rings are offered without a frame - you decide on your own whether to add the GU10 or GX5.3 frame to it. The holders for building in a ceiling work well as additional lighting at homes, in bars and in restaurants, in places where you want to emphasize an arrangement of a room or to display its fragment.

Decorative ring without a ceramic frame
Enclosure material: aluminum alloy



ALREN DTL-W	26753	5905339267535	max 35	biały mat matte white	w jednej osi in one axis	15
ALREN DTL-B	26754	5905339267542	max 35	czarny mat black matt	w jednej osi in one axis	15
ALREN DTL-C/M	26756	5905339267566	max 35	chrom mat chrome matte	w jednej osi in one axis	15

[V] 12 AC; 12 DC; 220-240 AC						IP 20		 5+25
 60	 83x83	 0,5m				CE	UK CA	

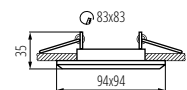

ARLEN DTL

Kanlux COLIE

PIERŚCIEŃ OPRAWY PUNKTOWEJ ► RING FOR SPOTLIGHT FITTINGS



COLIE DTO-G



COLIE DTO-W



COLIE DTO-B



COLIE DTO-GR



Ozdobne pierścienie Kanlux COLIE pozwolą na zrealizowanie bardzo oryginalnych aranżacji w każdym domu. Charakteryzują się eleganckim i oryginalnym wzornictwem, zapewniając przy tym dyskretny rozsył światła. Seria COLIE przeznaczona jest do wbudowania w sufit. Znakomicie sprawdzają się jako oświetlenie pomocnicze, zarówno w domach, w barach jak i restauracjach, wszędzie tam gdzie chcemy zaakcentować ciekawą aranżację pomieszczenia.

Pierścieni dekoracyjny bez oprawki ceramicznej

Materiał obudowy: stop aluminium

The Kanlux COLIE decorative rings will allow making very original arrangements in each house. They are characterized by elegant and original design ensuring, at the same time, discrete distribution of light. The COLIE series is intended for building in a ceiling. They work well as additional lighting both at homes, in bars and in restaurants, in places where you want to emphasize an interesting arrangement of a room.

Decorative ring without a ceramic frame

Enclosure material: aluminum alloy



COLIE DTO-W	26740	5905339267405	max 10	biały mat matte white	w jednej osi in one axis	15
COLIE DTO-G	26741	5905339267412	max 10	złoty anodowany gold anodised	w jednej osi in one axis	15
COLIE DTO-B	26743	5905339267436	max 10	czarny mat black matt	w jednej osi in one axis	15
COLIE DTO-GR	26744	5905339267443	max 10	szary grey	w jednej osi in one axis	15

IV					IP 20		
12 AC; 12 DC; 220-240 AC		Gx5,3/GU10			UK CA		5+25
Ø75	0,5m	MR16/PAR16	CE	UK CA			

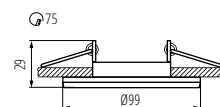

COLIE DTO

Kanlux NESTA

PIERŚCIEŃ OPRAWY PUNKTOWEJ ► RING FOR SPOTLIGHT FITTINGS



NESTA DSL-C



NESTA DSL-C/M



NESTA DTL-C



NESTA DTL-C/M

Oczka Kanlux NESTA dostępne są w wersji z ruchomym pierścieniem, pozwalającym na ukierunkowanie światła w daną stronę oraz z pierścieniem nieruchomym. Oprawy przeznaczone do wbudowania w sufit świetnie sprawdzają się jako oświetlenie pomocnicze, zarówno w domach, kawiarniach, restauracjach - wszędzie tam gdzie chcemy zaakcentować ciekawą aranżację pomieszczenia. Zestawiane w grupę oprawy te mogą również z powodzeniem pełnić funkcję oświetlenia głównego.

Pierścieni dekoracyjny bez oprawki ceramicznej

Materiał obudowy: stop aluminium

The Kanlux NESTA eyes are available in a version with a movable ring, allowing to direct light into a given side and with an immovable ring. The holders intended for building in a ceiling work well as additional lighting both at homes, in coffee shops and in restaurants, in places where you want to emphasize an interesting arrangement of a room. These holders combined in a group can also successfully perform the function of main light.

Decorative ring without a ceramic frame

Enclosure material: aluminum alloy



NESTA DSL-C	26747	5905339267474	max 10	chrom chrome	brak none	
NESTA DSL-C/M	26748	5905339267481	max 10	chrom mat chrome matte	brak none	
NESTA DTL-C	26751	5905339267511	max 10	chrom chrome	w jednej osi in one axis	30
NESTA DTL-C/M	26752	5905339267528	max 10	chrom mat chrome matte	w jednej osi in one axis	30

IV					IP 20	
12 AC; 12 DC; 220-240 AC		Gx5,3/GU10			UK CA	
5+25	0,5m	MR16/PAR16	CE	UK CA		

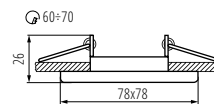

NESTA DSL

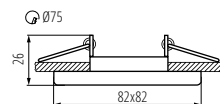

NESTA DTL

Kanlux EVIT

OPRAWA SUFITOWA PUNKTOWA ► CEILING-MOUNTED SPOTLIGHT FITTING

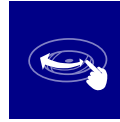

Kanlux EVIT to oprawa punktowa wykonana z aluminium. Posiada możliwość regulacji kierunku padania światła. Kanlux EVIT jest klasycznym oczkiem bez ozdóbek.

Materiał obudowy: stop aluminium

Kanlux EVIT is a spot-beam holder made of aluminium. It has a possibility of adjusting the direction of light. Kanlux EVIT is a classic eye without ornaments.

Enclosure material: aluminum alloy



EVIT CT-DTL50



EVIT CT-DT050



EVIT CT-DTL50-AL	18560	5905339185600	max 10	aluminium	w jednej osi in one axis	30
EVIT CT-DT050-AL	18561	5905339185617	max 10	aluminium	w jednej osi in one axis	30

				IP 20				
12 AC; 12 DC	Gx5,3	III		20		5+25	Ø70-75	
0,12	0,75	0,5m	MR-16	CE	EAC	UK CA		

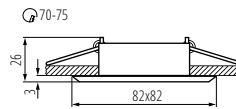

EVIT CT-DTL50

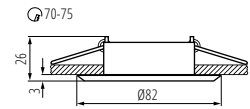

EVIT CT-DT050

Kanlux GWEN

OPRAWA SUFITOWA PUNKTOWA ► CEILING-MOUNTED SPOTLIGHT FITTING

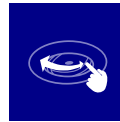

Kanlux GWEN to oczko, które idealnie pasuje do wnętrza eleganckich, stonowanych. Szyczkowane aluminium w czarnym kolorze doda szyku oświetlanemu wnętrzu.

Materiał obudowy: stop aluminium

Kanlux GWEN is an eye which perfectly fits into elegant, discreet interiors. Brushed aluminium in black colour will add stylishness to lighted interior.

Enclosure material: aluminum alloy



GWEN CT-DT050



GWEN CT-DTL50



GWEN CT-DTL50-B	18530	5905339185303	max 10	czarny anodowany black anodised	w jednej osi in one axis	30
GWEN CT-DT050-B	18531	5905339185310	max 10	czarny anodowany black anodised	w jednej osi in one axis	30

				IP 20				
12 AC; 12 DC	Gx5,3	III		20		5+25	Ø70-75	
0,12	0,75	0,5m	MR-16	CE	EAC	UK CA		

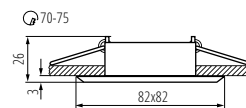

GWEN CT-DTL50

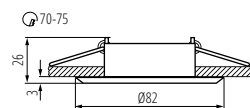

GWEN CT-DT050

Kanlux LUTO

OPRAWA SUFITOWA PUNKTOWA ► CEILING-MOUNTED SPOTLIGHT FITTING



LUTO CTX-DS02B-W



LUTO CTX-DS02B-C/M



LUTO CTX-DS02B-AB



LUTO CTX-DT02B-W



LUTO CTX-DT02B-C

Kanlux LUTO to linia klasycznych oczek w stonowanych kolorach. Biały, patynowany miedź czy matowy chrom dyskretnie dodadzą uroku nie tylko przestrzeni domowej, ale również hotelom i kawiarniom.

Materiał obudowy: stop aluminium

Kanlux LUTO is a line of classic eyes in discreet colours. The white, patina brass or mat chromium will discretely add charm to a home space as well as to hotels and coffee shops.

Enclosure material: aluminum alloy



LUTO CTX-DS02B-W	02580	5905339025807	max 10	biały white	brak none
LUTO CTX-DS02B-C/M	02583	5905339025838	max 10	chrom mat chrome matte	brak none
LUTO CTX-DS02B-AB	02584	5905339025845	max 10	mosiądz matowy matt brass	brak none
LUTO CTX-DT02B-W	02590	5905339025906	max 10	biały white	w jednej osi in one axis 15
LUTO CTX-DT02B-C	02591	5905339025913	max 10	chrom chrome	w jednej osi in one axis 15

[V] 12 AC; 12 DC	Gx5,3	III	IP 20	5+25	0,12
0,75	0,5m	MR-16	CE	EAC	UK CA

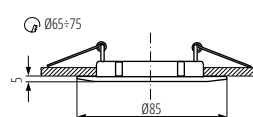

LUTO CTX-DS02B

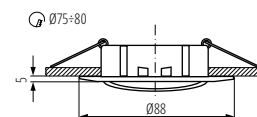

LUTO CTX-DT02B

Kanlux NAVI

OPRAWA SUFITOWA PUNKTOWA ► CEILING-MOUNTED SPOTLIGHT FITTING



NAVI CTX-DT10-W



NAVI CTX-DT10-C/M



NAVI CTX-DS10-B



NAVI CTX-DT10-B

Kanlux NAVI to rodzina prostych w swojej formie, różnorodnych opraw punktowych o bardzo szerokich możliwościach zastosowania.

Materiał obudowy: stop aluminium

Kanlux NAVI is a family of simple in their form, diverse spot-beam holders with very broad possibilities of use.

Enclosure material: aluminum alloy



NAVI CTX-DT10-W	02550	5905339025500	max 10	biały white	w jednej osi in one axis 15
NAVI CTX-DT10-C/M	02553	5905339025531	max 10	chrom mat chrome matte	w jednej osi in one axis 15
NAVI CTX-DS10-B	25990	5905339259905	max 10	czarny mat black matt	brak none
NAVI CTX-DT10-B	25991	5905339259912	max 10	czarny mat black matt	w jednej osi in one axis 15

[V] 12 AC; 12 DC	Gx5,3	III	IP 20	5+25	0,12
0,75	0,5m	MR-16	CE	EAC	UK CA

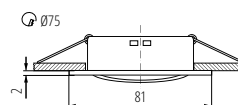

NAVI CTX-DT10

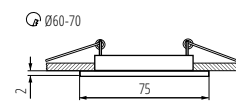

NAVI CTX-DS10

Kanlux VIDI

OPRAWA SUFITOWA PUNKTOWA ► CEILING-MOUNTED SPOTLIGHT FITTING



VIDI CTC-5515-W



VIDI CTC-5514-C/M



VIDI CTC-5514-B



VIDI CTC-5514-W



VIDI CTC-5514-C



VIDI CTC-5515-C/M



VIDI CTC-5515-B

Kanlux VIDI to rodzina prostych w swojej formie, różnorodnych opraw punktowych. Możemy komponować z nich różnorodne zestawy oświetleniowe wybierając wśród wielu kolorów tych aluminiowych opraw.

















Materiał obudowy: stop aluminium

Kanlux VIDI is a family of simple in their form, diverse spot-beam holders. You can compose diverse lighting sets of them, choosing from among many colours of these aluminium holders.

Enclosure material: aluminum alloy



VIDI CTC-5515-W	02780	5905339027801	max 10	biały white	w jednej osi in one axis	15
VIDI CTC-5515-C/M	02783	5905339027832	max 10	chrom mat chrome matte	w jednej osi in one axis	15
VIDI CTC-5514-W	02790	5905339027900	max 10	biały white	brak none	
VIDI CTC-5514-C	02791	5905339027917	max 10	chrom chrome	brak none	
VIDI CTC-5514-C/M	02793	5905339027931	max 10	chrom mat chrome matte	brak none	
VIDI CTC-5514-B	25995	5905339259950	max 10	czarny mat black matt	brak none	
VIDI CTC-5515-B	25996	5905339259967	max 10	czarny mat black matt	w jednej osi in one axis	15

 12 AC; 12 DC	 Gx5,3			IP 20		 5+25		 0,12
 0,75	 0,5m		 MR-16	 CE	 ERC	 UK CA		

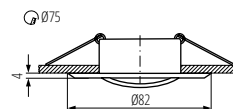

VIDI CTC-5515

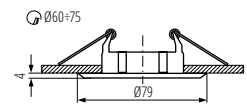

VIDI CTC-5514

Kanlux RADAN

OPRAWA SUFITOWA PUNKTOWA

► CEILING-MOUNTED SPOTLIGHT FITTING



RADAN CT-DT050



RADAN CT-DS050

Kanlux RADAN to proste oczka, które rozjaśniają każde pomieszczenie. Sami wybierzesz źródło światła jak i wersję oprawy - z regulacją lub nieruchomą.

Materiał obudowy: stop aluminium

Kanlux RADAN are simple eyes which will light up each room. You can choose a source of light and a version of the holder on your own - with adjustment or immovable.

Enclosure material: aluminum alloy



RADAN CT-DT050	07360	5905339073600	max 10	aluminium	w jednej osi in one axis	30
RADAN CT-DS050	07362	5905339073624	max 10	aluminium	brak none	

[VI]	Gx5,3	III	↑	IP 20	🏠	🌡️ 5+25	🌀	1ml
12 AC; 12 DC								0,12
0,75	0,5m	MR-16	CE	ERC	UK CA	🌿		

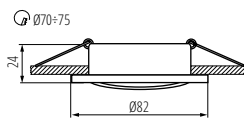

RADAN CT-DT0

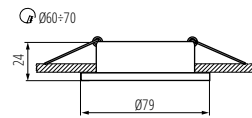

RADAN CT-DS0

Kanlux TESON

OPRAWA SUFITOWA PUNKTOWA

► CEILING-MOUNTED SPOTLIGHT FITTING



TESON AL-DLSL50



TESON AL-DTL50



TESON AL-DS050

Kanlux TESON to proste oczka, które rozjaśniają każde pomieszczenie. Sami wybierzesz źródło światła jak i wersję oprawy - z regulacją lub nieruchomą.

Materiał obudowy: stop aluminium

Kanlux TESON are simple eyes which will light up each room. You can choose a source of light and a version of the holder on your own - with adjustment or immovable.

Enclosure material: aluminum alloy



TESON AL-DTL50	07371	5905339073716	max 10	aluminium	w jednej osi in one axis	30
TESON AL-DS050	07372	5905339073723	max 10	aluminium	brak none	
TESON AL-DLSL50	07373	5905339073730	max 10	aluminium	brak none	

[VI]	[Hz]	GU10	□	↑	IP 20	🏠	🌡️ 5+25	🧱
220-240 AC	50							
0,75+2,5	0,5m	PAR16	CE	ERC	UK CA	🌿		

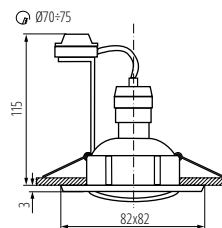

TESON AL-DTL

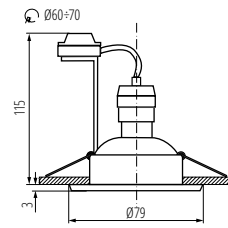

TESON AL-DSO

Kanlux HORN

OPRAWA SUFITOWA PUNKTOWA

► CEILING-MOUNTED SPOTLIGHT FITTING



HORN CTC-3114

Kanlux HORN to popularne, klasyczne oczko sufitowe. Ta oprawa to doskonały sposób na oświetlenie małych pomieszczeń, gdzie oprawy wiszące czy plafoniere zabiorą zbyt dużo przestrzeni. Oczko Kanlux HORN sprawdzi się jako główne źródło światła lub jako oprawa doświetlająca daną część pomieszczenia.

Materiał obudowy: stal

The popular Kanlux HORN mesh series is a cross-section of models; from classic to bold color combinations. Everyone can choose a model that is perfectly suited to their interior.

Enclosure material: steel



HORN CTC-3114-GM/N	02824	5905339028242	max 10	grafitowy / nikiel graphite / nickel	brak none	
--------------------	--------------	---------------	--------	--	-------------	--

[VI]	Gx5,3	III	↑	IP 20	🏠	🌡️ 5+25	🌀	1ml
12 AC; 12 DC								0,12
0,75	0,5m	MR-16	CE	ERC	UK CA	🌿		

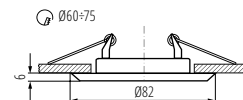

HORN CTC-3114

ARGUS II

PIERŚCIEŃ OPRAWY PUNKTOWEJ ► RING FOR SPOTLIGHT FITTINGS



ARGUS II CT-2115-BR/M

Kanlux ARGUS II to pierścienie dekoracyjne, które są odwzorowaniem popularnych oczek Kanlux ARGUS. Różnorodność wśród kształtów i kolorów sprawia, że każdy miłośnik klasyki znajdzie wśród nich coś dla siebie. Możemy tu zastosować oprawkę, która będzie pasować do trzonka GU10 lub Gx5,3, co pozwala na zastosowanie źródeł światła dopasowanych do przygotowanej instalacji.

Pierścieni dekoracyjny bez oprawki ceramicznej

Materiał obudowy: stal

Kanlux ARGUS II are decorative rings that reproduce the popular Kanlux ARGUS eyes. The variety of shapes and colors means that every classic lover will find something for themselves. We can use a lampholder that will fit a GU10 or Gx5.3 base, which allows the use of light sources tailored to the prepared installation.

Decorative ring without a ceramic frame
Enclosure material: steel



ARGUS II CT-2114-AN	37150	5905339371508	max 10	miedz matowa matte copper	brak none	
ARGUS II CT-2114-BR/M	37151	5905339371515	max 10	mosiądz matowy matt brass	brak none	
ARGUS II CT-2114-C	37152	5905339371522	max 10	chrom chrome	brak none	
ARGUS II CT-2114-C/M	37153	5905339371539	max 10	chrom mat chrome matte	brak none	
ARGUS II CT-2114-G	37154	5905339371546	max 10	złoty gold	brak none	
ARGUS II CT-2114-GM	37155	5905339371553	max 10	grafitowy graphite	brak none	
ARGUS II CT-2114-W	37156	5905339371560	max 10	biały white	brak none	
ARGUS II CT-2115-AN	37157	5905339371577	max 10	miedz matowa matte copper	w jednej osi in one axis	15
ARGUS II CT-2115-BR/M	37158	5905339371584	max 10	mosiądz matowy matt brass	w jednej osi in one axis	15
ARGUS II CT-2115-C	37159	5905339371591	max 10	chrom chrome	w jednej osi in one axis	15
ARGUS II CT-2115-C/M	37160	5905339371607	max 10	chrom mat chrome matte	w jednej osi in one axis	15
ARGUS II CT-2115-G	37161	5905339371614	max 10	złoty gold	w jednej osi in one axis	15
ARGUS II CT-2115-GM	37162	5905339371621	max 10	grafitowy graphite	w jednej osi in one axis	15
ARGUS II CT-2115-W	37163	5905339371638	max 10	biały white	w jednej osi in one axis	15

[V]						
12 AC; 12 DC; 220-240 AC		Gx5,3/GU10			IP 20	
5+25	0,5m		MR16/PAR16			

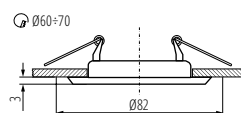

ARGUS II CT-2114

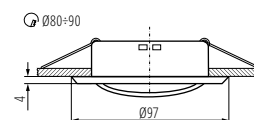

ARGUS II CT-2115

Kanlux

ARGUS II

PIERŚCIEŃ OPRAWY PUNKTOWEJ ► RING FOR SPOTLIGHT FITTINGS



ARGUS II CT-2114-C



ARGUS II CT-2114-W



ARGUS II CT-2114-C/M



ARGUS II CT-2114-AN



ARGUS II CT-2114-BR/M



ARGUS II CT-2114-GM



ARGUS II CT-2115-C



ARGUS II CT-2115-W



ARGUS II CT-2115-C/M



ARGUS II CT-2115-AN



ARGUS II CT-2115-BR/M



ARGUS II CT-2115-GM



ARGUS II CT-2115-G



TRIBIS II

ZESTAW OPRAW DO WBUDOWANIA WRAZ Z ŹRÓDŁEM

▶ A SET OF RECESSED DOWNLIGHTS WITH A LIGHT SOURCE (INCLUDED)



TRIBIS II O B

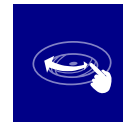

Kanlux TRIBIS II to kompletny zestaw 3 sztuk oczek, który składa się z: 3x pierścieni dekoracyjnych, 3x źródeł światła (TOMIV2 GU10) i 3x oprawek ceramicznych ze wspornikiem. Do wyboru mamy dwa kształty (kwadratowy i okrągły) i kilka wariantów kolorystycznych. Oczka Kanlux TRIBIS II posiadają możliwość regulacji kątowej o 50° dlatego swobodnie skierujemy je w pożądanym kierunku. Oprawy punktowe Kanlux TRIBIS II przeznaczone do wbudowania w sufit, świetnie sprawdzają się jako oświetlenie główne lub pomocnicze. Możesz umieścić je w grupie lub rozdzielić pomiędzy kilka miejsc.

Materiał obudowy: stal

Kanlux TRIBIS II is a complete set of 3 spots, which consists of: decorative rings, light sources and ceramic lamp holders with a bracket. We can choose between two shapes (square and round) and several color variants. Kanlux TRIBIS II spots can be angularly adjusted by 50°, so we can direct them in the desired direction. Kanlux TRIBIS II spotlights designed to be recessed into the ceiling, are perfect as main or additional lighting. You can put them in a group or split them among several places.

Enclosure material: steel



TRIBIS II L AB	23843	5905339238436	3 x max 10	patynowany mosiądz patinated brass	w jednej osi in one axis	50
TRIBIS II L C	23844	5905339238443	3 x max 10	chrom chrome	w jednej osi in one axis	50
TRIBIS II L C/M	23845	5905339238450	3 x max 10	chrom mat chrome matte	w jednej osi in one axis	50
TRIBIS II O AB	23846	5905339238467	3 x max 10	patynowany mosiądz patinated brass	w jednej osi in one axis	50
TRIBIS II O C	23847	5905339238474	3 x max 10	chrom chrome	w jednej osi in one axis	50
TRIBIS II O C/M	23848	5905339238481	3 x max 10	chrom mat chrome matte	w jednej osi in one axis	50
TRIBIS II L W	23849	5905339238498	3 x max 10	biały white	w jednej osi in one axis	50
TRIBIS II L B	23853	5905339238535	3 x max 10	czarny black	w jednej osi in one axis	50
TRIBIS II O W	23854	5905339238542	3 x max 10	biały white	w jednej osi in one axis	50
TRIBIS II O B	23855	5905339238559	3 x max 10	czarny black	w jednej osi in one axis	50

[V] 220-240 AC	[Hz] 50	GU10	IP 20	5+25	0,75+2,5	0,5m	PAR16 LED	SMD	4,9	400	120°	3000	80	≥15000
CE	EAC	UK CA												

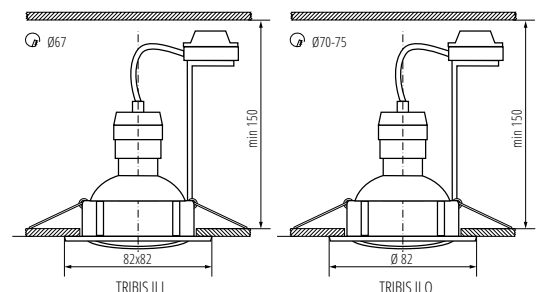

Kanlux

TRIBIS II

ZESTAW OPRAW DO WBUDOWANIA WRAZ Z ŹRÓDŁEM ► A SET OF RECESSED DOWNLIGHTS WITH A LIGHT SOURCE (INCLUDED)



TRIBIS II L AB



TRIBIS II L C



TRIBIS II L C/M



TRIBIS II L W



TRIBIS II L B



TRIBIS II O C/M



TRIBIS II O AB



TRIBIS II O C



TRIBIS II O W



DROXY IP65

PIERŚCIEŃ OPRAWY PUNKTOWEJ ► RING FOR SPOTLIGHT FITTINGS



Kanlux DROXY IP65 to rodzina pierścieni dekoracyjnych dedykowanych do łazienek i pomieszczeń o podwyższonej wilgotności (IP65/20). Rodzina tych pierścieni składa się z 2 modeli okrągłych opraw. Ich wyróżniającą cechą jest ozdobna, wyjątkowo gładka powierzchnia, która w połączeniu z matowymi kolorami (biały i czarny) daje niespotykane elegancji, acz dyskretny efekt w pomieszczeniu, w którym je zamontujemy.

Pierścień dekoracyjny bez oprawki ceramicznej
Materiał obudowy: stop aluminium

Kanlux DROXY IP65 is a family of decorative spotlights dedicated to bathrooms and rooms with high humidity (IP65 / 20). The ring family consists of 2 models of round housings. Their distinguishing feature is the decorative, exceptionally smooth surface, which, combined with matte colors (white and black), gives an unusually elegant, but discreet effect in the room where they are installed.

Decorative ring without a ceramic frame
Enclosure material: aluminum alloy



DROXY IP65 DSO-W



DROXY IP65 DSO-B



DROXY IP65 DSO-W	33125	5905339331250	max 10	biały white	brak none
DROXY IP65 DSO-B	33126	5905339331267	max 10	czarny black	brak none

[V] 12 AC; 12 DC; 220-240 AC				
(mm) Ø68				

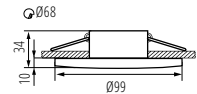

DROXY IP65 DSO

FLINI IP44

PIERŚCIEŃ OPRAWY PUNKTOWEJ ► RING FOR SPOTLIGHT FITTINGS



Kanlux FLINI to oprawy sufitowe dedykowane do łazienek i pomieszczeń o podwyższonej wilgotności. Dzięki swojej konstrukcji są one odporne na wilgoć (IP44). Kanlux FLINI dostępne są w dwóch kształtach - okrągłym i kwadratowym. Do wyboru mamy oprawę w kolorze białym matowym lub czarnym matowym. Dwie tak uniwersalne barwy pozwolą nam dopasować te lampy do każdego niemal wnętrza.

Pierścień dekoracyjny bez oprawki ceramicznej
Materiał obudowy: stop aluminium

Kanlux FLINI are ceiling luminaires dedicated for bathrooms and rooms with increased humidity. Thanks to their design, they are resistant to moisture (IP44). Kanlux FLINI are available in two shapes - round and square. You can choose between matt white or matt black. Two such universal colours will allow us to match these lamps to almost any interior.

Decorative ring without a ceramic frame
Enclosure material: aluminum alloy



FLINI IP44 DSL-W



FLINI IP44 DSL-B



FLINI IP44 DSO-B



FLINI IP44 DSO-W



FLINI IP44 DSL-B	33120	5905339331205	max 10	czarny black	brak none
FLINI IP44 DSL-W	33121	5905339331212	max 10	biały white	brak none
FLINI IP44 DSO-B	33122	5905339331229	max 10	czarny black	brak none
FLINI IP44 DSO-W	33123	5905339331236	max 10	biały white	brak none

[V] 12 AC; 12 DC; 220-240 AC			
(mm) Ø60			

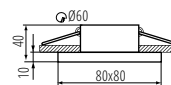

FLINI IP44 DSL

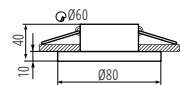

FLINI IP44 DSO

Kanlux QULES

OPRAWA SUFITOWA PUNKTOWA

► CEILING-MOUNTED SPOTLIGHT FITTING



QULES AC O-W



QULES AC O-C/M



QULES AC O-B

IP
44/20

Sufitowe oczka Kanlux QULES to jedne z najpopularniejszych opraw o podwyższonym IP. Idealnie nadają się do zamontowania w łazience lub innych miejscach o podwyższonej wilgotności.

Materiał obudowy: stop aluminium

The Kanlux QULES ceiling eyes are one of the most popular holders with increased IP. They are ideal for mounting in a bathroom or in other places with increased humidity.

Enclosure material: aluminum alloy



QULES AC O-W	26303	5905339263032	max 10	biały white	brak none
QULES AC O-C/M	26304	5905339263049	max 10	chrom mat chrome matte	brak none
QULES AC O-B	26306	5905339263063	max 10	czarny black	brak none

[V] 220-240 AC	[Hz] 50	GU10			IP 44/20		 -20+35	 Ø71-74
	 0,5m		PAR16	CE	EAC	UK CA		

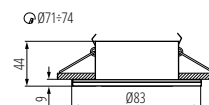

QULES AC O

Kanlux MARIN

OPRAWA SUFITOWA PUNKTOWA ► CEILING-MOUNTED SPOTLIGHT FITTING



MARIN CT-S80-C



MARIN CT-S80-B



MARIN CT-S80-SN



MARIN CT-S80-AB



MARIN CT-S80-W



MARIN CT-S80-C	04703	5905339047038	max 10	chrom chrome	brak none
MARIN CT-S80-SN	04704	5905339047045	max 10	nikiel mat nickel matte	brak none
MARIN CT-S80-AB	04710	5905339047106	max 10	mosiądz matowy matt brass	brak none
MARIN CT-S80-W	32500	5905339325006	max 10	biały white	brak none
MARIN CT-S80-B	32501	5905339325013	max 10	czarny mat black matt	brak none

[V] 12 AC; 12 DC	Gx5,3			IP 44/20		 Ø60-62		 0,12
 0,75	 0,5m		MR-16	CE	EAC	UK CA		

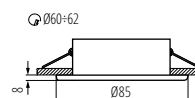

MARIN CT

IP
44/20

Kanlux MARIN to niewielkie szczelne oprawy sufitowe, których możemy użyć w miejscach o podwyższonej wilgotności. Swobodnie możemy je umieścić w łazience nad lustrem, w kuchni czy w pralni.

Materiał obudowy: stal

Kanlux MARIN means small and tight ceiling holders to be used in places with increased humidity. They can easily be placed in a bathroom above a mirror, in a kitchen or in a laundry.

Enclosure material: steel

IMBER LED

OPRAWA AKCENTOWA LED ► LED MIRROR LIGHT FITTING



IMBER LED



IMBER LED NW	23520	5905339235206	1	aluminium	40	105	4000
IMBER LED CW	23521	5905339235213	1	aluminium	40	105	6500
IMBER LED WW	23522	5905339235220	1	aluminium	40	105	3000

[V]	12 AC; 12 DC	≥20000	30000	≤60 Maczków	Ra 80	SMD	III	IP 65	House icon
Temperature	-20+50	House icon	Wiring icon	Ø27	0,1m	CE	ERAC	UK	Recycling icon

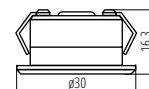

IMBER LED

OYO

AKCENT ŚWIETLNY LED ► LED MIRROR LIGHTS



OYO SLED



OYO SLED-CW	08121	5905339081216	0,22	chrom chrome	5	15	6500
-------------	-------	---------------	------	----------------	---	----	------

[V]	12 DC	30000	House icon	III	IP 68	House icon	Wiring icon	Ø8	0,2
Beam angle	Ø8	0,1m	W	23	CE	ERAC	UK	Recycling icon	

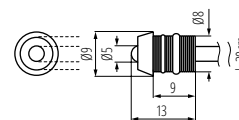

OYO SLED



Kanlux IMBER LED to wodoszczelna oprawa akcentowa do wbudowania. Jednym z jej atutów jest niska temperatura pracy, dzięki czemu może być bez przeszkód mocowana również w drewnie. Unikatowa konstrukcja oprawy to równomierna emisja światła, a zastosowane tu diody LED gwarantują dużą energooszczędność. Oprawa Kanlux IMBER LED to doskonały pomysł na podświetlenie kabin prysznicowych czy podbitek dachowych na zewnątrz domu.

Materiał obudowy: stop aluminium

Materiał klosza: tworzywo sztuczne

Kanlux IMBER LED is a waterproof holder intended for building in. Low temperature of work is one of its assets, thanks to which it can be easily mounted in wood as well. The unique structure of the holder means a regular emission of light and LED diodes used here guarantee high energy efficiency. The Kanlux IMBER LED holder is a perfect idea to highlight shower baths or outdoor soffits outside a house.

Enclosure material: aluminum alloy

Lampshade material: plastic



Kanlux OYO LED to punktowe akcenty świetlne, które zastosujemy jako oświetlenie ozdobne. Niewielkie punkty świetlne pomogą nam zrealizować śmiało projekty oświetleniowe również w saunach i łazienkach dzięki wysokiej szczelności - IP68.

OYO 2LED-CW w komplecie 2 sztuki

OYO 5LED-CW w komplecie 5 sztuk

Materiał obudowy: metal, tworzywo sztuczne

Kanlux OYO LED are spot-beam light accents to be used as decorative lighting. The small light points will help us to implement brave lighting projects also in saunas and bathrooms thanks to high tightness - IP68.

OYO 2LED-CW, 2 pcs included

OYO 5LED-CW, 5 pcs included

Enclosure material: Metal, plastic

Kanlux

ASTIM LED IP44

OPRAWA MEBLOWA LINIOWA LED ► LINEAR LED FURNITURE LIGHT



ASTIM IP44 8W-NW-B



ASTIM IP44 8W-NW-C



ASTIM IP44 8W-NW-W



ASTIM IP44 12W-NW-B



ASTIM IP44 12W-NW-W



ASTIM IP44 12W-NW-C



ASTIM IP44 8W-NW-B	34930	5905339349309	8	czarny black	590	4000
ASTIM IP44 8W-NW-W	34931	5905339349316	8	biały white	690	4000
ASTIM IP44 8W-NW-C	34932	5905339349323	8	chrom chrome	660	4000
ASTIM IP44 12W-NW-B	34933	5905339349330	12	czarny black	910	4000
ASTIM IP44 12W-NW-W	34934	5905339349347	12	biały white	1070	4000
ASTIM IP44 12W-NW-C	34935	5905339349354	12	chrom chrome	1010	4000

[V] 220-240 AC	[Hz] 50		 0,75+1,5	 ≥15000	 25000	 ≤6xMax/dam	 80	
	 IP 44	 5+30		 0,1m	 X120/Y105			

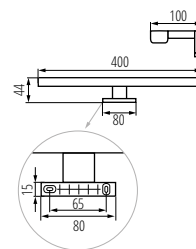

ASTIM IP44 8W

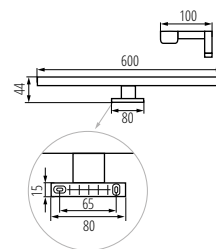

ASTIM IP44 12W

Kanlux

ROLSO

OPRAWA ŚCIENNA LED IP44 ► WALL-MOUNTED LED LIGHT FITTING, IP44



ROLSO LED IP44 15W-NW



ROLSO LED IP44 15W-NW	26700	5905339267009	15	biały / chrom white / chrome	1470	4000
-----------------------	--------------	---------------	----	--------------------------------	------	------

[V] 220-240 AC	[Hz] 50		 ≥15000	 25000	 ≤6xMax/dam	 80			 IP 44	
 5+30	 0,75+1,5	 0,1m		 lm W 98						



Kanlux ASTIM to oprawa łazienkowa o podwyższonej szczelności (IP44). Oprawy te charakteryzują się montażem do ramy lustra lub szafki. Dzięki trzem uniwersalnym kolorom można dopasować je do łazienek o tradycyjnym lub nowoczesnym wystroju.

Materiał obudowy: stop aluminium
Materiał klosza: tworzywo sztuczne

Kanlux ASTIM is a bathroom luminaire with increased tightness (IP44). These luminaires are mounted to a mirror frame or cabinet. With three versatile colours, you can match them to bathrooms with traditional or modern decor.

Enclosure material: aluminum alloy
Lampshade material: plastic



Kanlux ROLSO to nowoczesna oprawa domowa LED, która emituje wysokiej jakości światło, a jej dodatkowym atutem jest subtelny design, który doskonale współgra zwłaszcza z nowoczesnymi wnętrzami. Oprawa ta świetnie sprawdzi się jako oświetlenie łazienkowe, dzięki wysokiemu współczynnikowi IP (44) może być używana w pomieszczeniach o podwyższonej wilgotności.

Materiał obudowy: stop aluminium
Materiał klosza: tworzywo sztuczne

Kanlux ROLSO to nowoczesna oprawa domowa LED, która emituje wysokiej jakości światło, a jej dodatkowym atutem jest subtelny design, który doskonale współgra zwłaszcza z nowoczesnymi wnętrzami. Oprawa ta świetnie sprawdzi się jako oświetlenie łazienkowe, dzięki wysokiemu współczynnikowi IP (44) może być używana w pomieszczeniach o podwyższonej wilgotności.

Enclosure material: aluminum alloy
Lampshade material: plastic

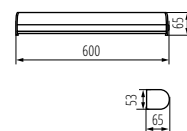

ROLSO LED IP44 15W-NW

ASTEN LED IP44

OPRAWA ŚCIENNA LED ► LED WALL MOUNTED FITTING



ASTEN LED IP44 8W-NW

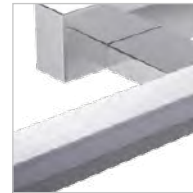

Kanlux ASTEN LED jest liniową oprawą ścienną, którą zastosujesz w miejscach o podwyższonej wilgotności (IP44). Bez obaw możesz zamontować ją nad lustrem w łazience. Lampa posiada wbudowane źródła światła oparte na diodach LED SMD, których trwałość wynosi przynajmniej 25000 godzin.

Materiał obudowy: stop aluminium

Materiał klosza: tworzywo sztuczne

Kanlux ASTEN LED is a linear wall luminaire to be used in places with increased humidity (IP44). You can easily mount it above the bathroom mirror. The lamp has a built-in light source based on SMD LED diodes, which lifetime is at least 25,000 hours.

Enclosure material: aluminum alloy

Lampshade material: plastic



ASTEN LED IP44 8W-NW	26680	5905339266804	8	chrom chrome	660	4000
ASTEN LED IP44 12W-NW	26681	5905339266811	12	chrom chrome	1010	4000
ASTEN LED IP44 15W-NW	26682	5905339266828	15	chrom chrome	1340	4000
ASTEN IP44 8W-NW-B	26683	5905339266835	8	czarny black	590	4000
ASTEN IP44 12W-NW-B	26684	5905339266842	12	czarny black	910	4000
ASTEN IP44 15W-NW-B	26685	5905339266859	15	czarny black	1230	4000
ASTEN IP44 8W-NW-W	26686	5905339266866	8	biały white	690	4000
ASTEN IP44 12W-NW-W	26687	5905339266873	12	biały white	1070	4000
ASTEN IP44 15W-NW-W	26688	5905339266880	15	biały white	1450	4000

[V] 220-240 AC	[Hz] 50	[°] X120/Y105	[h] ≥15000	[h] 25000	[lm] ≤60 MacAdam	Ra 80	SMD
[m]	[IP] 44	[°C] 5+30	[mm] 0,75÷1,5	[m]	[m]	[m]	[m]
[m]	[m]	[m]	[m]	[m]	[m]	[m]	[m]

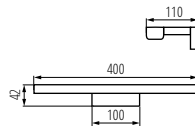

ASTEN LED IP44 8W

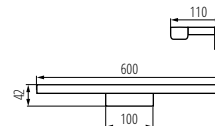

ASTEN LED IP44 12W

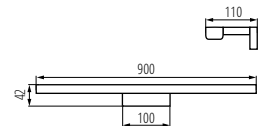

ASTEN LED IP44 15W

Kanlux

ASTEN LED IP44

OPRAWA ŚCIENNA LED ► LED WALL MOUNTED FITTING



ASTEN LED IP44 8W-NW



ASTEN LED IP44 12W-NW



ASTEN LED IP44 15W-NW



ASTEN IP44 8W-NW-B



ASTEN IP44 12W-NW-B



ASTEN IP44 15W-NW-B



ASTEN IP44 8W-NW-W



ASTEN IP44 12W-NW-W



ASTEN IP44 15W-NW-W



AKVO IP44 S

OPRAWA ŚCIENNA LED ► LED WALL MOUNTED FITTING

NEW



AKVO IP44 23W

AKVO IP44 20W

AKVO IP44 15W



AKVO IP44 15W-NW-W S



AKVO IP44 15W-NW-B S



AKVO IP44 15W-NW-C S



Kanlux AKVO IP44 S to LEDowe oprawy ścienne w trzech kolorach: białym, chromie i czarnym. Oprawy dostępne są w 3 długościach i trzech mocach 60cm – 15W, 80cm – 20W i 100cm – 23W. Lamy Kanlux AKVO S możesz zamontować w pionie i w poziomie na ścianie. To tworzy wiele możliwości aranżacji oświetlenia w łazience. Dodatkowo lamy te mają podwyższoną odporność na wilgoć IP44, co sprawia, że możesz bezpiecznie zamontować je w łazience czy w pralni. Lamy Kanlux AKVO IP44 S sprawdzają się doskonale jako oświetlenie pomieszczeń takich jak łazienka, pralnia, pomieszczenie gospodarcze, korytarz czy garderoba. Kanlux AKVO IP44 S wyposażone są w dyskretny włącznik umieszczony w obudowie oprawy. Lamy te mają wysoką skuteczność świetlną, ponad 100 lumenów z Wata, dzięki czemu pomagają Ci oszczędzać energię elektryczną.

Materiał obudowy: stop aluminium

Materiał klosza: tworzywo sztuczne

Kanlux AKVO IP44 S are wall and ceiling luminaires in three colors: white, chrome and black. The luminaire is available in 3 lengths and three powers: 60cm - 15W, 80cm - 20W and 100cm - 23W. Kanlux AKVO S lamps can be mounted vertically and horizontally, on the wall, which creates virtually unlimited arrangement possibilities. In addition, these lamps have increased resistance to moisture IP44, which means that you can safely mount them in the bathroom or laundry room. Kanlux AKVO IP44 S lamps are perfect for lighting rooms such as a bathroom, laundry room, utility room, corridor or wardrobe. Kanlux AKVO IP 44 S are equipped with a discreet switch located in the housing of the luminaire. These lamps have a high luminous efficiency, over 100 lumens per Watt, thanks to which they help you save electricity.

Enclosure material: aluminum alloy

Lampshade material: plastic



AKVO IP44 15W-NW-W S	36650	5905339366504	15	biały white	1600	4000
AKVO IP44 15W-NW-B S	36651	5905339366511	15	czarny black	1600	4000
AKVO IP44 15W-NW-C S	36652	5905339366528	15	chrom chrome	1600	4000
AKVO IP44 20W-NW-W S	36653	5905339366535	20	biały white	2300	4000
AKVO IP44 20W-NW-B S	36654	5905339366542	20	czarny black	2300	4000
AKVO IP44 20W-NW-C S	36655	5905339366559	20	chrom chrome	2300	4000
AKVO IP44 23W-NW-W S	36656	5905339366566	23	biały white	2750	4000
AKVO IP44 23W-NW-B S	36657	5905339366573	23	czarny black	2750	4000
AKVO IP44 23W-NW-C S	36658	5905339366580	23	chrom chrome	2750	4000

[V] 220-240 AC	[Hz] 50	15000	25000	Ra 80	SMD	
	IP 44	5+30		0,75-1,5	0,1m	

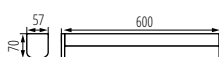

AKVO IP44 15W

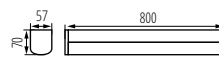

AKVO IP44 20W

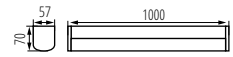

AKVO IP44 23W

Kanlux

AKVO IP44

OPRAWA ŚCIENNO-SUFITOWA LED ► WALL/CEILING LED FIXTURE

NEW



AKVO IP44 23W

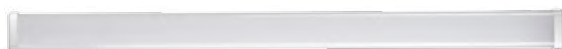

AKVO IP44 20W

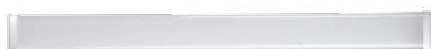

AKVO IP44 15W



AKVO IP44 15W-NW-W



AKVO IP44 15W-NW-B



AKVO IP44 15W-NW-C



Kanlux AKVO IP44 to oprawy ścienna sufitowe w trzech kolorach: białym, chromie i czarnym. Oprawy dostępne są w 3 długościach i trzech mocach 60cm – 15W, 80cm – 20W i 100cm – 23W. Lampy Kanlux AKVO możesz zamontować w pionie i w poziomie, na ścianie lub na suficie, co tworzy praktycznie nieograniczone możliwości aranżacji. Dodatkowo lampy te mają podwyższoną odporność na wilgoć IP44, co sprawia, że możesz bezpiecznie zamontować je w łazience czy w pralni. Lampy Kanlux AKVO IP44 sprawdzają się doskonale jako oświetlenie pomieszczeń takich jak łazienka, pralnia, pomieszczenie gospodarcze, korytarz czy garderoba. Lampy te mają wysoką skuteczność świetlną, ponad 100 lumenów z Wata, dzięki czemu pomagają Ci oszczędzać energię elektryczną.

Materiał obudowy: stop aluminium

Materiał klosza: tworzywo sztuczne

Kanlux AKVO IP44 are wall and ceiling luminaires in three colors: white, chrome and black. The luminaire is available in 3 lengths and three powers: 60cm - 15W, 80cm - 20W and 100cm - 23W. Kanlux AKVO lamps can be mounted vertically and horizontally, on the wall or on the ceiling, which creates virtually unlimited arrangement possibilities. In addition, these lamps have increased resistance to moisture IP44, which means that you can safely mount them in the bathroom or laundry room. Kanlux AKVO IP44 lamps are perfect for lighting rooms such as a bathroom, laundry room, utility room, corridor or wardrobe. These lamps have a high luminous efficiency, over 100 lumens per Watt, thanks to which they help you save electricity.

Enclosure material: aluminum alloy

Lampshade material: plastic

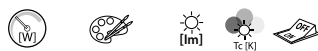

AKVO IP44 15W-NW-W	36659	5905339366597	15	biały white	1600	4000
AKVO IP44 15W-NW-B	36660	5905339366603	15	czarny black	1600	4000
AKVO IP44 15W-NW-C	36661	5905339366610	15	chrom chrome	1600	4000
AKVO IP44 20W-NW-W	36662	5905339366627	20	biały white	2300	4000
AKVO IP44 20W-NW-B	36663	5905339366634	20	czarny black	2300	4000
AKVO IP44 20W-NW-C	36664	5905339366641	20	chrom chrome	2300	4000
AKVO IP44 23W-NW-W	36665	5905339366658	23	biały white	2750	4000
AKVO IP44 23W-NW-B	36666	5905339366665	23	czarny black	2750	4000
AKVO IP44 23W-NW-C	36667	5905339366672	23	chrom chrome	2750	4000

[V]	[Hz]					
220-240 AC	50	15000	25000	80	SMD	
	IP 44					
		5+30		0,75-1,5	0,1m	
CE	EAC	UK CA				



AKVO IP44 15W

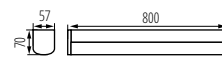

AKVO IP44 20W

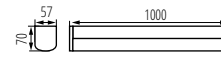

AKVO IP44 23W

ERINUS LED

OPRAWA PRZYSCHODOWA LED ► STAIRCASE LED LIGHT FITTING



ERINUS LED L W



ERINUS LED L W-VVV	33320	5905339333209	12 DC	0,8	biały white	15	3000
ERINUS LED L W-NVV	33321	5905339333216	12 DC	0,8	biały white	15	4000
ERINUS LED O W-VVV	33322	5905339333223	12 DC	0,8	biały white	15	3000
ERINUS LED O W-NVV	33323	5905339333230	12 DC	0,8	biały white	15	4000
ERINUS LED LL W-VVV	33324	5905339333247	12 DC	1,5	biały white	30	3000
ERINUS LED LL W-NVV	33325	5905339333254	12 DC	1,5	biały white	30	4000
ERINUS LED L GR-NVV	33327	5905339333278	12 DC	0,8	szary grey	15	4000
ERINUS LED LL GR-VVV	33330	5905339333308	12 DC	1,5	szary grey	30	3000
ERINUS LED LL GR-NVV	33331	5905339333315	12 DC	1,5	szary grey	30	4000
ERINUS LED L B-VVV	33332	5905339333322	12 DC	0,8	czarny black	15	3000
ERINUS LED L B-NVV	33333	5905339333339	12 DC	0,8	czarny black	15	4000
ERINUS LED O B-VVV	33334	5905339333346	12 DC	0,8	czarny black	15	3000
ERINUS LED O B-NVV	33335	5905339333353	12 DC	0,8	czarny black	15	4000
ERINUS LED LL B-VVV	33336	5905339333360	12 DC	1,5	czarny black	30	3000
ERINUS LED LL B-NVV	33337	5905339333377	12 DC	1,5	czarny black	30	4000

≥ 15000	30000	ellipse $\leq 0,1$ MacAdam	Ra 80	III	IP 20	House icon	Arrow icon
0,1m	SMD	$^{\circ}\text{C}$ 5+25	CE	EAC	UK CA	Recycle symbol	

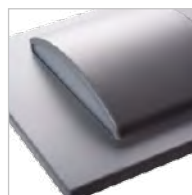

Kanlux ERINUS to wyjątkowa seria opraw przyschodowych wykonanych z tworzywa. Oprawy te charakteryzują się niezwykłą lekkością z powodu materiałów, z których zostały stworzone, a jednocześnie są wykonane z dużą precyzją i dbałością o detale. Oprawy Kanlux ERINUS są bardzo cienkie, dzięki czemu licują się za ścianą i stanowią jej dyskretną dekorację. Do wyboru mamy trzy kolory (biały, czarny i szary), dwie barwy światła (ciepła i neutralna) i trzy różne modele opraw. Kanlux ERINUS L to kwadratowa oprawa świecąca w jedną stronę, model LL świeci w dwie strony, a model Kanlux ERINUS O to okrągła oprawa świecąca w jedną stronę.

Materiał obudowy: tworzywo sztuczne

Materiał klosza: tworzywo sztuczne

Kanlux ERINUS is a unique series of premium stairwaf fittings made of plastic. These luminaires are characterized by exceptional lightness due to the materials from which they were made, and at the same time they are made with great precision and attention to detail. Kanlux ERINUS are very thin, so they flush with the wall line and make it a discreet decoration. We have three colors to choose (white, black and gray), two colors of light (warm and neutral light) and three different models of luminaires. The Kanlux ERINUS L is a square luminaire glowing in one direction, the LL model shines in both directions, and the Kanlux ERINUS O is a round luminaire glowing in one direction.

Enclosure material: plastic

Lampshade material: plastic

Ø60

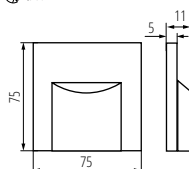

ERINUS LED L

Ø60

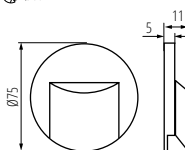

ERINUS LED O

Ø60

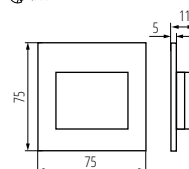

ERINUS LED LL

Kanlux

ERINUS LED

OPRAWA PRZYSCHODOWA LED ▶ STAIRCASE LED LIGHT FITTING

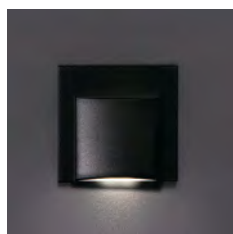

ERINUS LED L B



ERINUS LED L W



ERINUS LED L GR

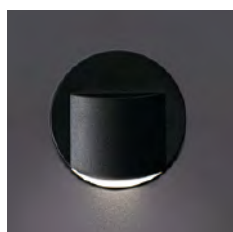

ERINUS LED O B



ERINUS LED O W

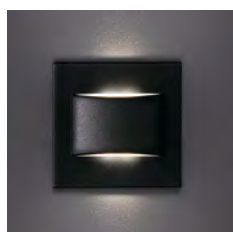

ERINUS LED LL B



ERINUS LED LL W



ERINUS LED LL GR





APUS LED AC



APUS LED PIR B



APUS LED B



APUS LED W

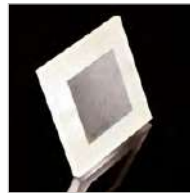

Kanlux APUS to nowoczesny design połączony z atrakcyjnym efektem świecenia. To doskonały pomysł na podświetlenie schodów i korytarzy lub na zaakcentowanie wystroju pomieszczeń. Unikatowa konstrukcja oprawy zapewnia równomierną emisję światła. Wersja AC wyposażona jest w zasilacz 230V, który mieści się w puszcze, a wersja PIR w czujnik ruchu. Czujnik wykrywa ruch/włącza oświetlenie niezależnie od natężenia światła w otoczeniu.

Materiał obudowy: stal nierdzewna szlifowana, tworzywo sztuczne

Kanlux APUS means modern design combined with an attractive effect of lighting. It is a perfect idea to highlight stairs and corridors or to emphasize decor of rooms. The unique structure of the holders ensures even emission of light. The AC version is equipped with 230V power supply unit which fits into a box and the PIR version is equipped with a motion sensor. The sensor detects movement / turns lights on regardless of the ambient light intensity.

Enclosure material: polished stainless steel, plastic



APUS LED VW	23106	5905339231062	12 DC	0,8	stal nierdzewna	stainless steel	13	3000
APUS LED CW	23107	5905339231079	12 DC	0,8	stal nierdzewna	stainless steel	15	6500
APUS LED AC-VW	23800	5905339238009	220-240 AC	1,3	stal nierdzewna	stainless steel	13	3000
APUS LED AC-CW	23801	5905339238016	220-240 AC	1,3	stal nierdzewna	stainless steel	15	6500
APUS LED AC B-NW	26536	5905339265364	220-240 AC	1,3	czarny	black	14	4000
APUS LED AC B-VW	26537	5905339265371	220-240 AC	1,3	czarny	black	13	3000
APUS LED B-NW	26538	5905339265388	12 DC	0,8	czarny	black	14	4000
APUS LED B-VW	26539	5905339265395	12 DC	0,8	czarny	black	13	3000
APUS LED W-VW	26840	5905339268402	12 DC	0,8	biały	white	13	3000
APUS LED W-CW	26841	5905339268419	12 DC	0,8	biały	white	15	6500
APUS LED PIR VW	27370	5905339273703	12 DC	0,8	stal nierdzewna	stainless steel	13	3000
APUS LED W-NW	27378	5905339273789	12 DC	0,8	biały	white	14	4000
APUS LED PIR NW	27379	5905339273796	12 DC	0,8	stal nierdzewna	stainless steel	14	4000
APUS LED PIR B-NW	29856	5905339298560	12 DC	0,8	czarny	black	14	4000
APUS LED PIR B-VW	29857	5905339298577	12 DC	0,8	czarny	black	13	3000
APUS LED NW	32488	5905339324887	12 DC	0,8	stal nierdzewna	stainless steel	14	4000

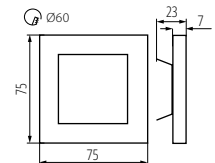

APUS LED

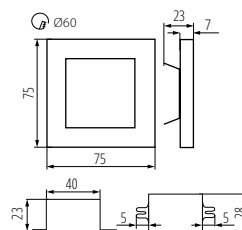

APUS LED AC

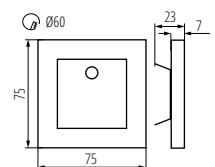

APUS LED PIR

≥20000	50000	ellipse ≤ 60 MacAdam	Ra 80	IP 20	0,1m	0,18
SMD	5+25					

TERRA LED

OPRAWA PRZYSCHODOWA LED ▶ STAIRCASE LED LIGHT FITTING



TERRA LED B; TERRA LED AC B



TERRA LED PIR B



TERRA LED W



Kanlux TERRA to nowoczesny design połączony z atrakcyjnym efektem świecenia. To doskonały pomysł na podświetlenie schodów i korytarzy lub na zaakcentowanie wystroju pomieszczeń. Unikatowa konstrukcja oprawy zapewnia równomierną emisję światła. Wersja AC wyposażona jest w zasilacz 230V, który mieści się w puszcze, a wersja PIR w czujnik ruchu. Czujnik wykrywa ruch/włącza oświetlenie niezależnie od natężenia światła w otoczeniu.

Materiał obudowy: stal nierdzewna szlifowana, tworzywo sztuczne

Kanlux TERRA means modern design combined with an attractive effect of lighting. It is a perfect idea to highlight stairs and corridors or to emphasize decor of rooms. The unique structure of the holders ensures even emission of light. The AC version is equipped with 230V power supply unit which fits into a box and the PIR version is equipped with a motion sensor. The sensor detects movement / turns lights on regardless of the ambient light intensity.

Enclosure material: polished stainless steel, plastic



TERRA LED WW	23102	5905339231024	12 DC	0,8	stal nierdzewna stainless steel	13	3000
TERRA LED CW	23104	5905339231048	12 DC	0,8	stal nierdzewna stainless steel	15	6500
TERRA LED AC-WW	23806	5905339238061	220-240 AC	1,3	stal nierdzewna stainless steel	13	3000
TERRA LED W-WW	26842	5905339268426	12 DC	0,8	biały white	13	3000
TERRA LED W-CW	26843	5905339268433	12 DC	0,8	biały white	15	6500
TERRA LED B-NW	26848	5905339268488	12 DC	0,8	czarny black	14	4000
TERRA LED B-WW	26849	5905339268495	12 DC	0,8	czarny black	13	3000
TERRA LED PIR B-NW	29860	5905339298607	12 DC	0,8	czarny black	14	4000
TERRA LED PIR B-WW	29861	5905339298614	12 DC	0,8	czarny black	13	3000

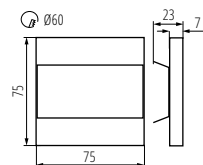

TERRA LED

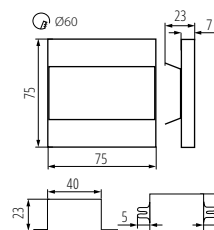

TERRA LED AC

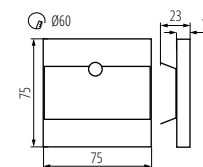

TERRA LED PIR B

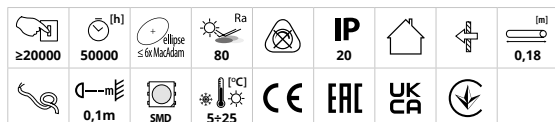

SABIK LED

OPRAWA PRZYSCHODOWA LED ► STAIRCASE LED LIGHT FITTING



SABIK LED; SABIK LED AC



SABIK LED PIR



SABIK MINI LED B



SABIK LED B



SABIK LED WW	23108	5905339231086	12 DC	0,8	stal nierdzewna stainless steel	13	3000
SABIK MINI LED WW	23109	5905339231093	12 DC	0,8	stal nierdzewna stainless steel	13	3000
SABIK LED CW	23110	5905339231109	12 DC	0,8	stal nierdzewna stainless steel	15	6500
SABIK MINI LED CW	23111	5905339231116	12 DC	0,8	stal nierdzewna stainless steel	15	6500
SABIK LED AC-WW	23802	5905339238023	220-240 AC	1,3	stal nierdzewna stainless steel	13	3000
SABIK LED PIR WW	27374	5905339273741	12 DC	0,8	stal nierdzewna stainless steel	13	3000
SABIK LED B-NW	29852	5905339298522	12 DC	0,8	czarny black	14	4000
SABIK LED B-WW	29853	5905339298539	12 DC	0,8	czarny black	13	3000
SABIK MINI LED B-NW	29854	5905339298546	12 DC	0,8	czarny black	14	4000
SABIK MINI LED B-WW	29855	5905339298553	12 DC	0,8	czarny black	13	3000
SABIK LED PIR B-NW	29858	5905339298584	12 DC	0,8	czarny black	14	4000
SABIK LED PIR B-WW	29859	5905339298591	12 DC	0,8	czarny black	13	3000
SABIK MINI LED NW	32490	5905339324900	12 DC	0,8	stal nierdzewna stainless steel	14	4000

≥20000	50000	s (in Macieksdam)	Ra 80		IP 20			0,18
	0,1m		5+25					

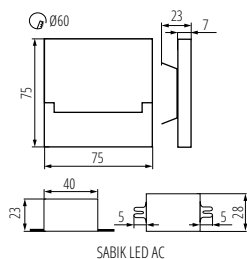

SABIK LED AC

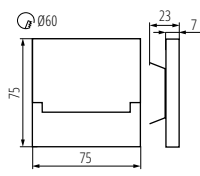

SABIK LED

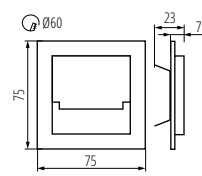

SABIK MINI LED

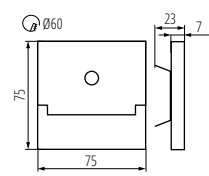

SABIK LED PIR

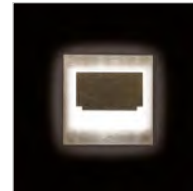
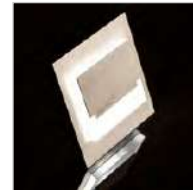

Kanlux SABIK to nowoczesny design połączony z atrakcyjnym efektem świecenia. To doskonały pomysł na podświetlenie schodów i korytarzy lub na zaakcentowanie wystroju pomieszczeń. Unikatowa konstrukcja oprawy zapewnia równomierną emisję światła. Wersja AC wyposażona jest w zasilacz 230V, który mieści się w puszcze, a wersja PIR w czujnik ruchu. Czujnik wykrywa ruch/włącza oświetlenie niezależnie od natężenia światła w otoczeniu.

Materiał obudowy: stal nierdzewna szlifowana, tworzywo sztuczne

Kanlux SABIK means modern design combined with an attractive effect of lighting. It is a perfect idea to highlight stairs and corridors or to emphasize decor of rooms. The unique structure of the holders ensures even emission of light. The AC version is equipped with 230V power supply unit which fits into a box and the PIR version is equipped with a motion sensor. The sensor detects movement / turns lights on regardless of the ambient light intensity.

Enclosure material: polished stainless steel, plastic

SOLA LED

OPRAWA PRZYSCHODOWA LED ▶ STAIRCASE LED LIGHT FITTING



SOLA LED



SOLA LED B; SOLA LED AC B

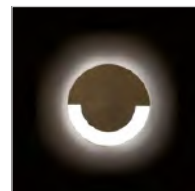

Kanlux SOLA to nowoczesny design połączony z atrakcyjnym efektem świecenia. To doskonały pomysł na podświetlenie schodów i korytarzy lub na zaakcentowanie wystroju pomieszczeń. Unikatowa konstrukcja oprawy zapewnia równomierną emisję światła. Wersja AC wyposażona jest w zasilacz 230V, który mieści się w puszcze.

Materiał obudowy: stal nierdzewna szlifowana, tworzywo sztuczne

Kanlux SOLA means modern design combined with an attractive effect of lighting. It is a perfect idea to highlight stairs and corridors or to emphasize decor of rooms. The unique structure of the holders ensures even emission of light. The AC version is equipped with 230V power supply unit which fits into a box.

Enclosure material: polished stainless steel, plastic



SOLA LED VV	23100	5905339231000	12 DC	0,8	stal nierdzewna stainless steel	13	3000
SOLA LED AC-VV	23804	5905339238047	220-240 AC	1,3	stal nierdzewna stainless steel	13	3000
SOLA LED B-NW	27558	5905339275585	12 DC	0,8	czarny black	14	4000
SOLA LED B-WV	27559	5905339275592	12 DC	0,8	czarny black	13	3000
SOLA LED NW	32491	5905339324917	12 DC	0,8	stal nierdzewna stainless steel	14	4000

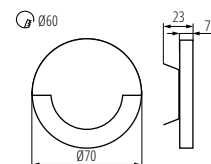

SOLA LED

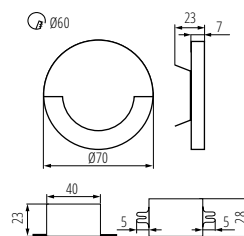

SOLA LED AC

Kanlux

IRS 3XAAA

OPRAWA PRZYSCHODOWA LED ► STAIRCASE LED LIGHT FITTING

NEW



IRS3XAAA LED PIR W-NW



Kanlux IRS to akumulatorowa lampka schodowa zasilana trzema bateriami AAA. Lampka może działać w jednym z trzech trybów - ON - stałe włączenia/OFF - stałe wyłączenie/AUTO - włącza się przy niskim natężeniu światła lub ruchu (lampka posiada czujnik zmierzchu i ruchu). Lampkę Kanlux IRS zamontujesz za pomocą taśmy lub dwóch śrub montażowych (w zestawie). Dużą zaletą lampki jest możliwość montażu w miejscach gdzie nie mamy wyprowadzonej instalacji elektrycznej.

Materiał obudowy: tworzywo sztuczne

Materiał klosza: tworzywo sztuczne

Kanlux IRS to akumulatorowa lampka schodowa zasilana trzema bateriami AAA. Lampka może działać w jednym z trzech trybów - ON - stałe włączenia/OFF - stałe wyłączenie/AUTO - włącza się przy niskim natężeniu światła lub ruchu (lampka posiada czujnik zmierzchu i ruchu). Lampkę Kanlux IRS zamontujesz za pomocą taśmy lub dwóch śrub montażowych (w zestawie). Dużą zaletą lampki jest możliwość montażu w miejscach gdzie nie mamy wyprowadzonej instalacji elektrycznej.

Enclosure material: plastic

Lampshade material: plastic



IRS3XAAA LED PIR W-NW | 37392 | 5905339373922 | 3 x 1,5 DC | 0,3 | biały | white | 10 | 4000

25000 [h]	Ra 80		IP 54			0,1m	0+25 [°C]
33	max 5 [m]	PIR					

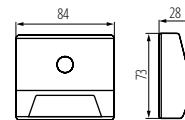

IRS3XAAA LED PIR W-NW

Kanlux

MEFIS LED

OPRAWA PRZYSCHODOWA LED ► STAIRCASE LED LIGHT FITTING



MEFIS LED W-NW



MEFIS LED B-NW



Kanlux MEFIS LED to nietypowa seria opraw przyschodowych. Oprawa ta dostępna jest w kolorze białym, czarnym i szarym, co daje swobodę doboru koloru do wnętrza. Oprawa Kanlux MEFIS LED to nietuzinkowy kształt i skupiony strumień świetlny, możemy go więc skierować tak, aby oświetlały punkty, na których nam zależy.

Materiał obudowy: tworzywo sztuczne

Kanlux MEFIS LED is an untypical series of stair fittings. This fitting is available in white, black and grey colours, thus you can choose the colour that matches the interior. Kanlux MEFIS LED fitting is in an original shape and is characterized by a focused luminous flux, thus you can direct it so that it will light points which you wish.

Enclosure material: plastic



MEFIS LED W-NW | 32495 | 5905339324955 | 12 DC | 0,7 | biały | white | 35 | 4000
MEFIS LED B-NW | 32497 | 5905339324979 | 12 DC | 0,7 | czarny | black | 35 | 4000

≥20000	50000	ellipse ≤ for MaxAdam	Ra 80	IP 20			0,18 [m]
	0,1m	SMD	5+25 [°C]				

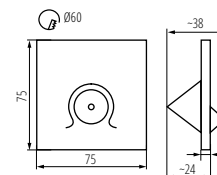

MEFIS LED

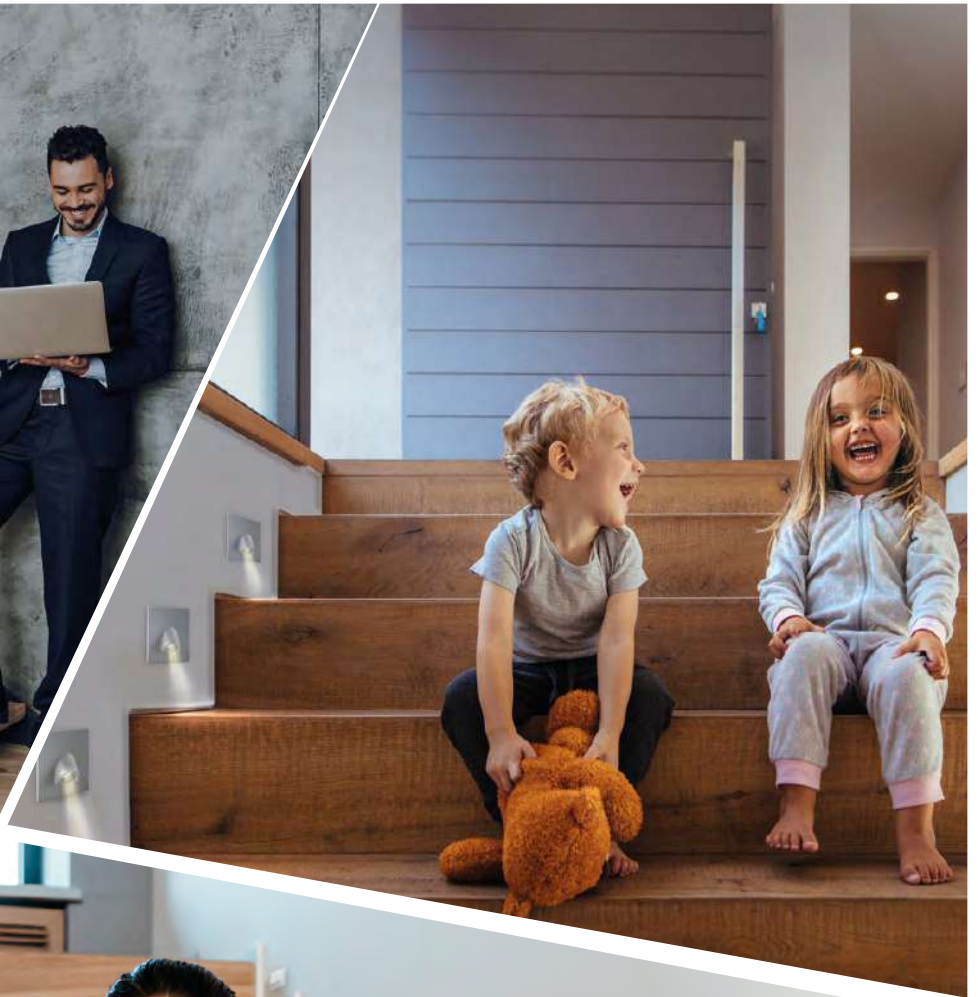
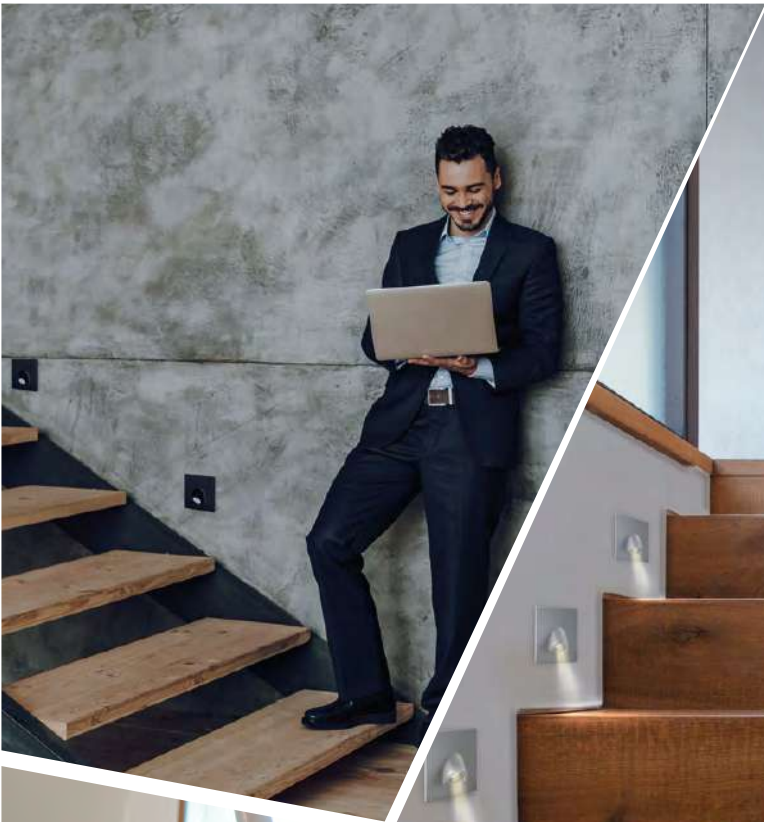

Kanlux ZEPO

OPRAWA PODSZAFKOWA PUNKTOWA ► UNDER-CABINET SPOTLIGHT FITTING



ZEPO LFD-T02/S-W



ZEPO LFD-T02/S-B



ZEPO LFD-T02/S-W



ZEPO LFD-T02-C/M



ZEPO LFD-T02-B



ZEPO LFD-T02-W

Lampy Kanlux ZEPO to typ oświetlenia przeznaczony do montażu pod szafki m.in. nad kuchennym blatem. Dostępne są w popularnych kolorach: czarnym, białym i srebrnym (chrom), co pozwala je dopasować do każdego niemal typu wnętrza. Kanlux ZEPO dostępne są w wersji z wyłącznikiem lub bez (wersja z włącznikiem ma w nazwie oznaczenie „S”). Do tych lamp pasują wymienne źródła światła z gwintem G4.

Oprawy ZEPO LFD-T02/S-C/M, ZEPO LFD-T02/S-B i ZEPO LFD-T02/S-W wyposażone są we włącznik ON/OFF.

Materiał obudowy: stal
Materiał klosza: szkło

The Kanlux ZEPO series of eyes is the lighting intended under cabinets, for example, above a table top in a kitchen. ZEPOs are available in a version with an OFF switch and without it. JC with G4 thread is a light source intended for the eyes.

ZEPO LFD-T02/S-C/M light fixtures provided with a power switch

Enclosure material: steel
Lampshade material: glass



ZEPO LFD-T02-C/M	04381	5905339043818	max 10	chrom mat chrome matte	
ZEPO LFD-T02/S-C/M	04386	5905339043863	max 10	chrom mat chrome matte	✓
ZEPO LFD-T02-B	36630	5905339366306	max 10	czarny black	
ZEPO LFD-T02-W	36631	5905339366313	max 10	biały white	
ZEPO LFD-T02/S-B	36632	5905339366320	max 10	czarny black	✓
ZEPO LFD-T02/S-W	36633	5905339366337	max 10	biały white	✓

12 AC; 12 DC		IP 20			
0,5m	0,1	5+25			

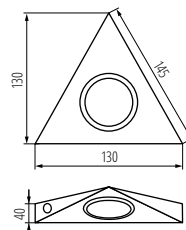

ZEPO LFD-T02/S

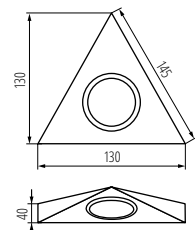

ZEPO LFD-T02

Kanlux

MERA LED

OPRAWA PODSZAFKOWA LED ► LED UNDER CABINET FITTING



MERA LED 5W NW



MERA LED 10W NW



MERA LED 15W NW



MERA LED 20W NW



Kanlux MERA LED to oprawa podszafkowa ze zintegrowanym źródłem światła LED. Oprawy są dostępne w rozmiarach od 28 do 114 cm, ponadto możemy je łączyć w linii (do 5 opraw) z pomocą łączników Kanlux MERA LED PP.

Materiał obudowy: tworzywo sztuczne

Materiał klosza: tworzywo sztuczne

Kanlux MERA LED is an under-cupboard luminaire with an integrated LED light source. The luminaires are available in sizes ranging from 28 to 114 cm. Moreover, we can connect them in lines (up to 5 luminaires) using Kanlux MERA LED PP connectors.

Enclosure material: plastic

Lampshade material: plastic



Model	Code	Part No.	Length [cm]	Color	Width [mm]	Height [mm]
MERA LED 5W NW	29210	5905339292100	5	biały white	490	4000
MERA LED 10W NW	29211	5905339292117	10	biały white	1040	4000
MERA LED 15W NW	29212	5905339292124	15	biały white	1600	4000
MERA LED 20W NW	29213	5905339292131	20	biały white	2030	4000

[V]	[Hz]	[°]	[h]	[lm]	[Ra]	[SMD]	[IP]
220-240 AC	50	150	≥15000	30000	≤60°/Nischdam	80	20
[m]	[m]	[°C]	[CE]	[EAC]	[UK CA]	[Down Arrow]	
0,3m	1,5	5+25					

AKCESORIA ► ACCESSORIES

MERA LED PP | 29214 | 5905339292148 | Przewód do łączenia opraw MERA LED PP | Luminaire connecting cable MERA LED PP

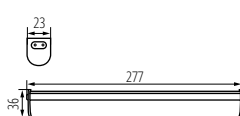

MERA LED 5W NW

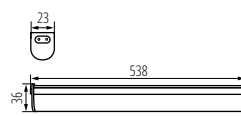

MERA LED 10W NW

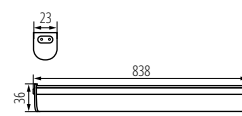

MERA LED 15W NW



MERA LED 20W NW

Kanlux LINUS LED

OPRAWA PODSZAFKOWA LED ► LED UNDER CABINET FITTING



Oprawa podszafkowa Kanlux LINUS LED posiada klasyczny i uniwersalny design. Dzięki swym kompaktowym rozmiarom lampa idealnie sprawdzi się do podświetlania różnego rodzaju mebli, szafek jak i półek. Kanlux LINUS LED można łączyć przelotowo przy pomocy przewodu LINUS LINK.

Materiał obudowy: tworzywo sztuczne
Materiał klosza: tworzywo sztuczne

Kanlux LINUS LED under-cabinet holder has classic and universal design. Thanks to its compact dimensions, the lamp will ideally highlight different types of furniture, cabinets and shelves. Kanlux LINUS LED can be combined on a pass-through basis by means of LINUS LINK cable.

Enclosure material: plastic
Lampshade material: plastic



LINUS LED 4W-NW



LINUS LED 7W-NW



LINUS LED 4W-NW	27590	5905339275905	4	biały white	390	4000
LINUS LED 7W-NW	27591	5905339275912	7	biały white	760	4000

[V]	[Hz]	[h]	[lm]	Ra	SMD	IP
220-240 AC	50	≥15000	30000	≤6x Macadam	80	20
[m]	[m]	[m]	[m]	[°C]	CE	UKCA
1,5	0,1m	5+25				

AKCESORIA ► ACCESSORIES

LINUS LINK | **14977** | 5907540960618 | Przewód do łączenia opraw LINUS LINK | Luminaire connecting cable LINUS LINK

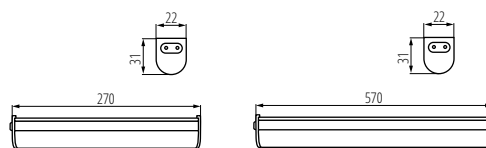

LINUS LED 4W

LINUS LED 7W

Kanlux HAXA LED

OPRAWA AKCENTOWA LED ► LED MIRROR LIGHT FITTING



HAXA-DSO



Ścienne-sufitowa oprawa punktowa Kanlux HAXA LED to niewielkie oczko, które zastosujemy jako oświetlenie uzupełniające.

Do prawidłowego działania wymagany zasilacz elektroniczny o prądzie stałym 350mA, np. ADI 350 lub RICO dostępny w ofercie Kanlux

Materiał obudowy: stop aluminium
Materiał klosza: tworzywo sztuczne

The wall and ceiling spot-beam holder Kanlux HAXA LED is a small eye to be used as additional lighting.

An electronic 350-mA DC power supply unit is required for proper functioning, e.g. ADI 350 or RICO available from Kanlux

Enclosure material: aluminum alloy
Lampshade material: plastic

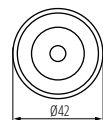
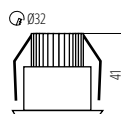

HAXA-DSO



HAXA-DSO POWER LED-B	08103	5905339081032	1,2	aluminium	110	20	3000	F
----------------------	--------------	---------------	-----	-----------	-----	----	------	---

In [mA]	[h]	Ra	[lm]	[°]	[K]	Ei
350	≥20000	40000	80	≤6x Macadam	80	20
[m]	[m]	[m]	[m]	[°C]	CE	UKCA
0,1	0,1	0,1m	90°			

Kanlux GAVI LED

OPRAWA MEBLOWA PUNKTOWA LED ► LED SPOTLIGHT FITTING FOR FURNITURE UNITS



GAVI LED18 SMD-WW-C/M



GAVI LED18 SMD-WW-C/M | **19761** | 5905339197610 | 0,8 | chrom mat | chrome matte | 42 | 3000

[V] 12 DC		 ≥15000	 30000	 ≤60 (Maxdäm)	 Ra 80			 IP 20	
 5+25	 0,1m	 Ø60	 0,14	 53					

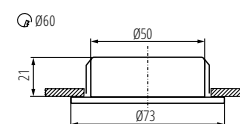

GAVI LED18 SMD-WW-C/M

Kanlux GAVI

OPRAWA MEBLOWA PUNKTOWA ► SPOTLIGHT FITTING FOR FURNITURE UNITS



GAVI CT-2116B-W



GAVI CT-2116B-W	00810	5905339008107	max 10	biały white
GAVI CT-2116B-C	00811	5905339008114	max 10	chrom chrome
GAVI CT-2116B-C/M	00815	5905339008152	max 10	chrom mat chrome matte

[V] 12 AC; 12 DC			 IP 20		 5+25	
 0,5m	 Ø60					



GAVI CT-2116B-C



GAVI CT-2116B-C/M



Kanlux GAVI to oprawy meblowe wykonane ze szkła i stali. Bezpretensjonalna kolorystyka pozwala im dyskretnie wpasować się w miejsce montażu.

Materiał obudowy: stal

Kanlux GAVI are furniture fittings made of glass and steel. Unpretentious colour scheme allows them to discretely fit into the place of assembly.

Enclosure material: steel

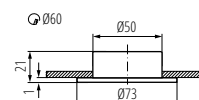

GAVI CT-2116B



Kanlux GAVI LED to oprawy meblowe wykonane ze szkła i stali. Bezpretensjonalna kolorystyka pozwala im dyskretnie wpasować się w miejsce montażu. Oprawy Kanlux GAVI LED posiadają zintegrowane źródło światła

Materiał obudowy: stal

Kanlux GAVI LED are furniture fittings made of glass and steel. Unpretentious colour scheme allows them to discretely fit into the place of assembly. Kanlux GAVI LED holders have an integrated source of light

an electronic 350-mA DC power supply unit is required for proper functioning, e.g. ADI 350 or RICO available from Kanlux

Enclosure material: steel

Kanlux

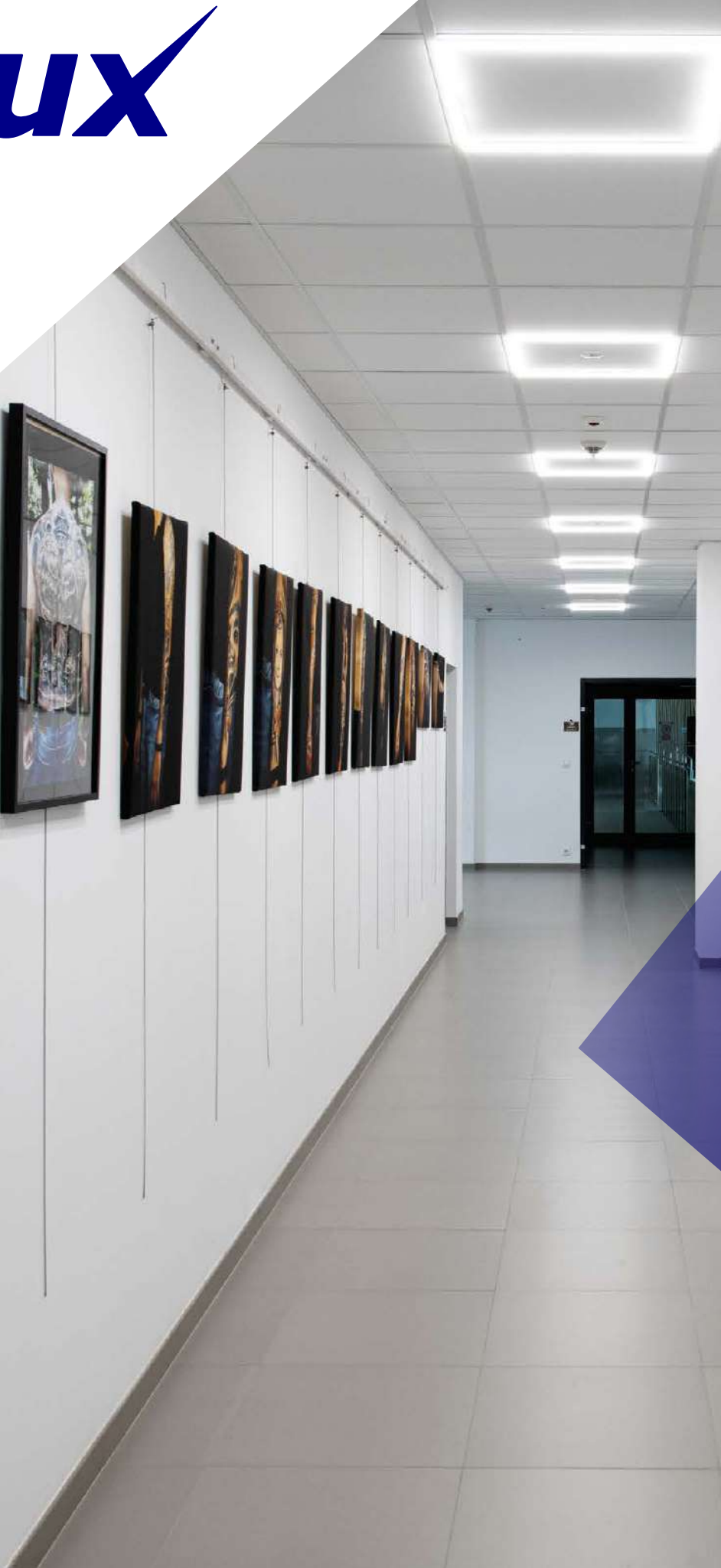



OPRAWY TECHNICZNE I ARCHITEKTONICZNE
TECHNICAL AND ARCHITECTURAL FIXTURES

**Rozświetlamy już tysiące mieszkań,
setki biur i inwestycji.**

**Rozwijamy się dotrzymując kroku
pędzącej technologii, ale również
słuchając Twoich potrzeb.**

We are already lighting up thousands of flats,
and hundreds of offices and investment buildings.
We are developing at the same rate as all
the develop keeping pace with fast
evolving technology, all the while listening
to your needs.



*dane fotometryczne znajdziesz na:
photometric data you can find on:*

► [kanlux.com](https://www.kanlux.com)

Kanlux BLINGO BL

PANEL LED PODTYNKOWY ► RECESSED-MOUNTED LED PANEL



Kanlux BLINGO LED to panele typu backlight. Wyposażone są w puszkę przyłączeniową z szybkozłączką, pozwalającą na przelotowe łączenie ze sobą paneli, a także przyspieszają ich montaż. W znacznej części paneli Kanlux BLINGO LED zasilacz został zintegrowany z oprawą, dzięki czemu możemy m.in. umieścić je w dowolnej ramce Kanlux ADTR i przeprowadzić montaż natynkowy paneli.* Ponadto dostępna jest cała gama akcesoriów do paneli Kanlux BLINGO (m.in. klipsy G-K oraz linki zwieszane).

*W modelach BLINGO TN24-28W6060NW, BLINGO IPRN38W 6060NW oraz BLINGO PU 36W 6262 NW zasilacz nie jest złączony z oprawą, należy łączyć je z odpowiednią ramką Kanlux ADTR-H.

5 lat Gwarancji na warunkach oświadczenia gwarancyjnego, dostępnego na stronie internetowej

Atest PZH: Numer B.BK.60112.0189.2023, ważny do 2028-06-28

Materiał obudowy: stal

Materiał klosza: tworzywo sztuczne

Materiał panelu/ramki: stal

Kanlux BLINGO LED are backlight panels. They are equipped with a junction box with a quick connector, which allows for pass-through connection of panels and speeds up their installation. In most panels from the Kanlux BLINGO LED family, the power supply has been integrated with the luminaire, thanks to which we can, among others: place them in any Kanlux ADTR frame and perform surface-mounted panels.* In addition, a whole range of accessories for Kanlux BLINGO panels is available (including GK clips and suspended cables).

*In the BLINGO TN24-28W6060NW, BLINGO IPRN38W 6060NW and BLINGO PU 36W 6262 NW models, the power supply is not connected to the fixture, they must be connected to the appropriate Kanlux ADTR-H frame.

5 years Warranty under the terms of the warranty statement, available on our website

Enclosure material: steel

Lampshade material: plastic

Panel/frame material: steel

	INDEX	BLINGO 24W 4320 60NW	BLINGO U24W 4000 60NW	BLINGO 34W 4080 60NW	BLINGO 34W 3740 60WW	BLINGO 34W 4080 60CW	BLINGO U34W 4080 60NW	BLINGO 34W 4080 120NW	BLINGO U34W 4080 120N	BLINGO 38W 4560 60NW	BLINGO 38W 4560 120NW	BLINGO TN38W 6060 NW	BLINGO TUN48W 6060 NW	BLINGO PU 36W 6262 NW	BLINGO TN24-28W6060NW	BLINGO IPRN38W 6060NW
SPN PANEL 120	37336							✓	✓		✓					
SPN PANEL 60-62	37335	✓	✓	✓	✓	✓	✓			✓		✓	✓	✓	✓	✓
CLIPS PANEL 120	37338							✓	✓		✓					
CLIPS PANEL 60-62	37337	✓	✓	✓	✓	✓	✓			✓		✓	✓	✓	✓	✓
ADTR 6060 B	27615	✓	✓	✓	✓	✓	✓			✓		✓	✓			
ADTR 6060 SR	27610	✓	✓	✓	✓	✓	✓			✓		✓	✓			
ADTR 6060 W	27613	✓	✓	✓	✓	✓	✓			✓		✓	✓			
ADTR-S 6060 W	27616	✓	✓	✓	✓	✓	✓			✓		✓	✓			
ADTR 12030 B	27614							✓	✓		✓					
ADTR 12030 SR	27612							✓	✓		✓					
ADTR 12030 W	27611							✓	✓		✓					
ADTR-H 6060 B	29845	✓	✓	✓	✓	✓	✓			✓		✓	✓		✓	✓
ADTR-H 6060 SR	29844	✓	✓	✓	✓	✓	✓			✓		✓	✓		✓	✓
ADTR-H 6060 W	29843	✓	✓	✓	✓	✓	✓			✓		✓	✓		✓	✓
ADTR-S-H 6060 W	27617	✓	✓	✓	✓	✓	✓			✓		✓	✓		✓	✓
ADTR-H 76MM 6060 W	33398	✓	✓	✓	✓	✓	✓			✓		✓	✓		✓	✓
ADTR-H 12030 B	33391							✓	✓		✓					
ADTR-H 12030 SR	33392							✓	✓		✓					
ADTR-H 12030 W	33390							✓	✓		✓					
ADTR-H 6262 W	33435													✓		



ADTR W, SR, B

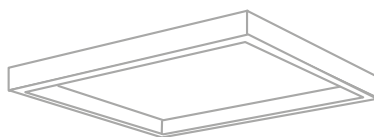

ADTR 6060 - 600 x 600 x 45mm
ADTR-H 6060 - 600 x 600 x 65mm
ADTR-H 6262 - 627 x 627 x 65mm
ADTR-H 76MM - 600 x 600 x 76mm

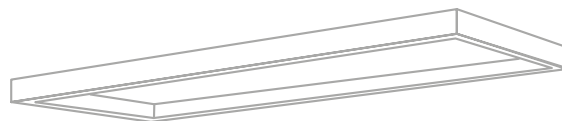

ADTR 12030 - 1200 x 300 x 45mm
ADTR-H 12030 - 1200 x 300 x 65mm

Kanlux

BLINGO CV

PANEL LED PODTYNKOWY ► RECESSED-MOUNTED LED PANEL



NEW



BLINGO U E125LM 60NW



BLINGO U E125LM 120NW

						Driver [index]
BLINGO U E125LM 30NW	37271	5905339372710	max 21,6	3000	biały white	37272 (600mA, 24W)
BLINGO U E125LM 60NW	37265	5905339372659	max 36	4000/5000	biały white	37269 (850mA, 32W); 37270 (1100mA, 40W)
BLINGO U E125LM 120NW	37266	5905339372666	max 36	4000/5000	biały white	37269 (850mA, 32W); 37270 (1100mA, 40W)

90	≥50000	50000	Tc [K] 4000	ellipse s 60/MaxKam	Ra 80	SMD
IP 20	5+25	5+25		0,5m		
UGR 19						

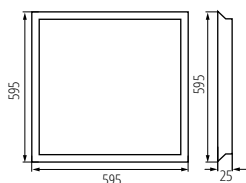

BLINGO U E125LM 60NW

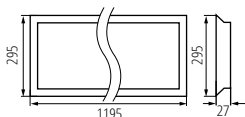

BLINGO U E125LM 120NW



BLINGO U E125LM 30NW



LOW
UGR



Panele Kanlux BLINGO CV posiadają mikropryzmatyczną strukturę klosza, obniżającą efekt oślnienia (niższy wskaźnik UGR). Trwałość produktu to 50.000 godzin, co pozwala nam udzielić na te panele 5 lat gwarancji. Kanlux BLINGO CV nie posiadają zasilacza w komplecie, można je wyposażyć w dedykowane zasilacze z możliwością sterowania (1-10V lub DALI) oraz wersje ON-OFF.

5 lat Gwarancji na warunkach oświadczenia gwarancyjnego, dostępnego na stronie internetowej

Materiał obudowy: stal

Materiał klosza: tworzywo sztuczne

Materiał panelu/ramki: stal

Kanlux BLINGO CV panels have a microprismatic structure of the lampshade, which reduces the glare effect (lower UGR index). The durability of the product is 50,000 hours, which allows us to provide a 5-year warranty on these panels. Kanlux BLINGO CV do not have a power supply included, they can be equipped with dedicated power supplies with controllability (1-10V or DALI) and ON-OFF power supply units.

5 years Warranty under the terms of the warranty statement, available on our website

Enclosure material: steel

Lampshade material: plastic

Panel/frame material: steel

BLINGO CV

PANEL LED PODTYNKOWY ► RECESSED-MOUNTED LED PANEL

ZASILACZ ► DRIVER



SEC(mA)



BLINGO DALI SET 38W	28515	5905339372727	45	800	DALI
BLINGO DRV42W DALI BK	37267	5905339372697	42	450-1100	DALI
BLINGO DRV40W1-10V BK	37268	5905339372703	40	600-1050	1-10V
BLINGO DRV 32W ON-OFF	37269	5905339372680	32	850	-
BLINGO DRV 40W ON-OFF	37270	5905339372673	40	1100	-
BLINGO DRV 24W ON-OFF	37272	5905339285157	24	600	-

NEW

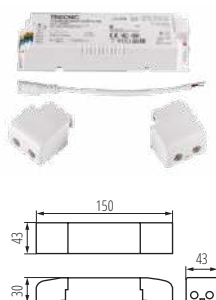

BLINGO DALI SET 38W

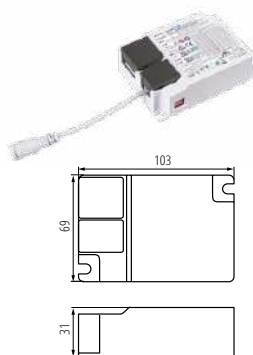

BLINGO DRV40W1-10V BK 37268
BLINGO DRV42W DALI BK 37267

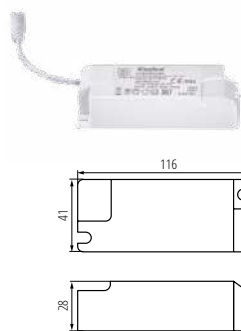

BLINGO DRV 24W ON-OFF 37272
BLINGO DRV 32W ON-OFF 37269
BLINGO DRV 40W ON-OFF 37270

INDEX	BLINGO U E125LM		
	30NW	60NW	120NW
BLINGO DRV 24W ON-OFF	37272	✓	
BLINGO DRV 32W ON-OFF	37269		✓
BLINGO DRV 40W ON-OFF	37270		✓
BLINGO DRV40W1-10V BK	37268	✓	✓
BLINGO DRV42W DALI BK	37267	✓	✓
BLINGO DALI SET 38W	28515	✓	✓
SPN PANEL 120	37336		✓
SPN PANEL 60-62	37335	✓	✓
CLIPS PANEL 120	37338		✓
CLIPS PANEL 60-62	37337	✓	✓
ADTR-H 6060 W	29843		✓
ADTR-H 12030 W	33390		✓
ADTR-H 3060 W	33393	✓	



CLIPS PANEL 120



SPN PANEL 120

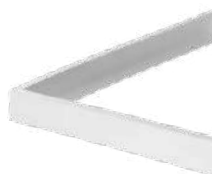

ADTR-H W

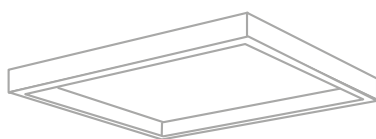

ADTR-H 6060 - 600 x 600 x 65mm



ADTR-H 3060 - 300 x 600 x 65mm



ADTR-H 12030 - 1200 x 300 x 65mm

BRAVO LED

PANEL LED PODTYNKOWY ► RECESSED-MOUNTED LED PANEL



BRAVO PU 36W6060



BRAVO PU28W3060



BRAVO S 40W6060



BRAVO S 40W12030

UGR Driver [index]

BRAVO PU36W6060NNW	28002	5905339280022	36	4320	4000	110	biały white	<19	28025
BRAVO PU28W3060NNW	28551	5905339285515	28	3360	4000	90	biały white	<19	28029
BRAVO S 40W6060NNW	28010	5905339280107	40	4000	4000	110	biały white		28026
BRAVO S 40W12030NNW	28022	5905339280220	40	4000	4000	110	biały white		28026

ZASILACZE ► DRIVERS

BRAVO DRIVER 28W	28029	
BRAVO DRIVER 36W	28025	
BRAVO DRIVER 40W	28026	
BRAVO DALI SET 36W	28508	

IN OUT



BRAVO DRIVER

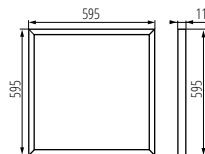

BRAVO 6060

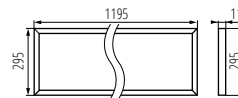

BRAVO 12030

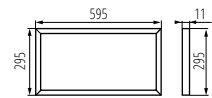

BRAVO 3060

BRAVO LED

PANEL LED PODTYNKOWY ► RECESSED-MOUNTED LED PANEL



Panele Kanlux BRAVO to specjalnie wybrane komponenty dla jeszcze większej satysfakcji z ich użytkowania. Aluminiowa ramka, specjalnie dobrane diody LED, odbłyśnik i dyfuzor rozpraszający światło to tylko niektóre atuty paneli Kanlux BRAVO LED. Kolejnym atutem tych paneli jest wysoka skuteczność świetlna. Panele Kanlux BRAVO LED nie posiadają zasilacza w komplecie.

5 lat Gwarancji na warunkach oświadczenia gwarancyjnego, dostępnego na stronie internetowej
Do prawidłowego działania wymagany jest zasilacz elektroniczny dostępny w ofercie KANLUX.

Materiał obudowy: stal
Materiał klosza: tworzywo sztuczne
Materiał panelu/ramki: stal

Kanlux BRAVO panels are specially selected components for even greater satisfaction with their use. Aluminium framework, specially selected LED diodes, reflector and diffuser distracting light are just some of the assets of Kanlux BRAVO LED panels. High luminous efficacy is another asset of these panels. Kanlux BRAVO LED panels do not have any power supply included.

5 years Warranty under the terms of the warranty statement, available on our website
The correct LED power supply available in the KANLUX range is required for proper operation.

Enclosure material: steel
Lampshade material: plastic
Panel/frame material: steel

*dotyczy BRAVO PU / only for BRAVO PU



BRAVO S/P GRIP



CLIPS BRAVO S/P



SPN BRAVO S/P



ADTR W, SR; B



PSR 100

	INDEX	BRAVO S/P GRIP		CLIPS BRAVO S/P		SPN BRAVO S/P		ADTR						PSR 100			
		60x60 / 62x62	120x30	60x60 / 62x62	120x30	60x60 / 62x62	120x30	30x60 (SR)	30x60 (W)	30x60 (B)	60x60 (SR)	60x60 (W)	60x60 (B)	120x30 (SR)	120x30 (W)	120x30 (B)	60x60 / 62x62
BRAVO PU36W6060NW W	28002	✓		✓		✓					✓	✓	✓				✓
BRAVO PU28W3060NW W	28551	✓		✓		✓		✓	✓	✓							✓
BRAVO S 40W6060NW W	28010	✓		✓		✓					✓	✓	✓				✓
BRAVO S 40W12030NW W	28022		✓		✓		✓							✓	✓	✓	

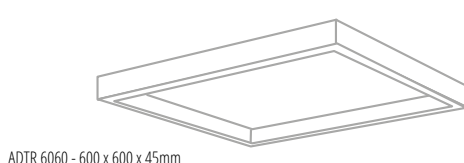

ADTR 6060 - 600 x 600 x 45mm

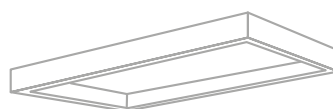

ADTR 3060 - 300 x 600 x 45mm



ADTR 12030 - 1200 x 300 x 45mm

AVAR LED

RAMKA OŚWIETLIENIOWA LED ► LED LIGHTING FRAME



AVAR 6060 40W-NW



AVAR 6060 40W-CW



AVAR 6262 40W-NW

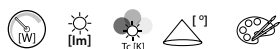

AVAR 6060 40W-NW	26770	5905339267702	40	3600	4000	110	biały white
AVAR 6060 40W-CW	26771	5905339267719	40	3800	6000	110	biały white
AVAR 6262 40W-NW	26773	5905339267733	40	3600	4000	110	biały white
AVAR 6262 40W-WW	26774	5905339267740	40	3400	3000	110	biały white

[V] 220-240 AC	[Hz] 50	[h] ≥15000	[h] 25000	[lm] ≤ 60/Nočlam	[Ra] 80	[SMD]	[IP] 20	[mm] 0,75	[mm] 0,5m	[CE]	[ERC]	[UK CA]	[Down Arrow]
[°C] 5+25	[Symbol]	[Symbol]	[Symbol]	[Symbol]	[Symbol]	[Symbol]	[Symbol]	[Symbol]	[Symbol]	[Symbol]	[Symbol]	[Symbol]	[Symbol]

AKCESORIA ► ACCESSORIES

AVAR DALI SET 40W	28512	5905339285126	Zestaw zawierający akcesoria i zasilacz umożliwiający komunikację zgodnie z protokołem DALI (28512) Set containing accessories and a power supply unit enabling communication in line with DALI protocol (28512)									
-------------------	--------------	---------------	---	--	--	--	--	--	--	--	--	--



Panele LED są bardzo popularnym elementem oświetleniowym wewnątrz biurowych. W dużej mierze zastąpiły oprawy rastrowe dzięki swojej trwałości, energooszczędności i estetyce. Kanlux AVAR LED to nowy kierunek paneli LED, którego wyróżnikiem jest nie tylko nowoczesna technologia, ale i sam kształt w formie ramki, która zapewnia mocne i efektowne światło.

AVAR 62x62 przeznaczony jest do alternatywnego rozmiaru systemów sufitowych (625mmx625mm)

Materiał obudowy: stop aluminium

Materiał klosza: tworzywo sztuczne

Materiał panelu/ramki: stop aluminium

LED panels are very popular lighting elements in office interiors. Due to their durability, energy efficiency and aesthetics, they have replaced extent raster luminaires to a large. Kanlux AVAR LED is a new dimension in LED panels distinguished by modern technology and the shape of frame which emits intense and impressive light.

AVAR 62x62 is intended for an alternative size of ceiling systems (625mmx625mm)

Enclosure material: aluminum alloy

Lampshade material: plastic

Panel/frame material: aluminum alloy

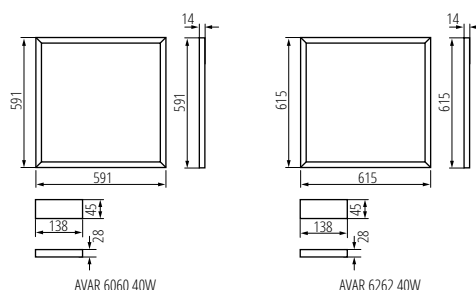



Kanlux REGIS

OPRAWA RASTROWA PODTYNKOWA ▶ EMBEDDED LOUVER FITTING



REGIS 3 EVG 418 PT, REGIS 3WS EVG 418 PT

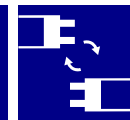

Kanlux REGIS to oprawy rastrowe podtynkowe, które dzięki zaczepom sprężynującym i szybkozłączkom charakteryzują się łatwym i szybkim montażem. Rastry to ciągle bardzo popularne rozwiązanie oświetleniowe wnętrz biurowych czy przemysłowych.

odbłyśnik w kształcie półparaboli / poprzeczki rastra w kształcie „V” / gniazda świetlówek zamaskowane odbłyśnikiem (wyjątkiem jest wersja REGIS 3 OPAL, REGIS 3WS OPAL która ma płytę opal)

w obudowie otwory ułatwiające zasilanie przelotowe

przewód ochronny na rastrze, dodatkowo zabezpieczający przed porażeniem elektrycznym za wyjątkiem wersji REGIS 3 OPAL, REGIS 3WS OPAL.

łatwy montaż rastra na zaczepach sprężynujących

szybkozłączka, do podłączenia zasilania, ułatwia i przyspiesza montaż, statecznik marki OSRAM w klasie A2

malowanie proszkowe

REGIS 3WS wyposażony w statecznik z „ciepłym startem”.

Materiał obudowy: stal

Materiał odbłyśnika: stop aluminium

Kanlux REGIS are raster recessed luminaires that can be mounted quickly and easily with spring clips and quick couplings. Raster lighting is still a very popular solution for office and industrial spaces.

reflector in the shape of a half-parabola / raster crossbars in the shape of “V” / sockets of fluorescent lamps masked with a reflector (exception: version REGIS 3 OPAL, REGIS 3WS OPAL with an opal board)

the casing contains openings facilitating straight through type power supply

protective cable on a raster, additionally securing against electric shock, except the version REGIS 3 OPAL, REGIS 3WS OPAL.

simple assembly of the raster on spring catches

quick coupling, for connection of power supply, facilitates and accelerates assembly, stabilizer by OSRAM in A2 class

powder coating

REGIS 3WS equipped with a stabilizer with “warm start”.

Enclosure material: steel

Reflector material: aluminum alloy



REGIS 3WS EVG 418 PT



REGIS 3WS OPAL 418 PT



REGIS 3 EVG 418 PT	19730	5905339197306	4 x 18	T8	G13	20	biały white
REGIS 3 OPAL 418 PT	19734	5905339197344	4 x 18	T8	G13	40	biały white
REGIS 3WS EVG 418 PT	25710	5905339257109	4 x 18	T8	G13	20	biały white
REGIS 3WS OPAL 418 PT	25713	5905339257130	4 x 18	T8	G13	40	biały white

[V] 220-240 AC	[Hz] 50				 5+25		
 1+2,5		 0,5m					

AKCESORIA ▶ ACCESSORIES

CLP-REGIS/PT	72333	5905339723338	CLP-REGIS/PT wspornik montażowy, służy do wbudowania opraw w gips-kartonowy sufit podwieszany. Zestaw: 4szt w komplecie. CLP-REGIS/PT mounting support, used for building in fittings in a plasterboard suspended ceiling. 4 pcs. in a set.
--------------	-------	---------------	---

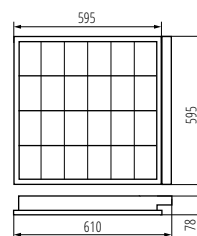

REGIS 3 EVG 418 PT; REGIS 3WS EVG 418 PT

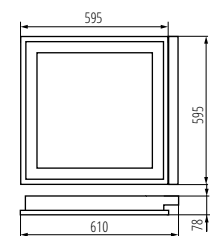

REGIS 3 OPAL 418 PT; REGIS 3WS OPAL 418 PT

Kanlux

REGIS 4LED

OPRAWA RASTROWA PODTYNKOWA ▶ EMBEDDED LOUVER FITTING



REGIS 4LED 418 PT



REGIS 4LED OPAL 418PT



REGIS 4LED 418 PT



REGIS 4LED OPAL 418PT	19736	5905339197368	4 x max 18	T8 LED	G13	biały white
REGIS 4LED 418 PT	22673	5905339226730	4 x max 18	T8 LED	G13	biały white

[V] 220-240 AC	[Hz] 50	ONE SIDE INPUT	IP 20	5±25
1+2,5	0,5m	CE	ERL	UK

AKCESORIA ▶ ACCESSORIES

CLP-REGIS/PT	72333	5905339723338	CLP-REGIS/PT wspornik montażowy, służy do wbudowania opraw w gips-kartonowy sufit podwieszany. Zestaw: 4szt w komplecie. CLP-REGIS/PT mounting support, used for building in fittings in a plasterboard suspended ceiling. 4 pcs. in a set.
--------------	--------------	---------------	---

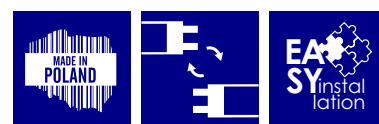

Oprawy Kanlux REGIS 4LED to tradycyjne oprawy rastrowe podtynkowe, przystosowane do świetlówek ledowych T8. Produkowane są w Polsce, z komponentów od polskich dostawców. Rastry to ciągle bardzo popularne rozwiązanie oświetleniowe wnętrz biurowych czy przemysłowych.

oprawy są przeznaczone do źródeł światła T8 LED 220-240 V ~; 50/60Hz z zasilaniem jednostronnym

oprawy przystosowane do zwieszania na zawieszach łatwy montaż rastra na zaczepach sprężynujących malowana proszkowo

Materiał obudowy: stal

Kanlux REGIS 4LED luminaires are traditional raster recessed luminaires adapted to T8 LED fluorescent lamps. They are manufactured in Poland of components provided by Polish suppliers. Raster lighting is still a very popular solution for office and industrial spaces.

the fittings are intended for light sources T8 LED 220-240 V ~; 50/60Hz with one-sided power supply

fittings adapted to suspension on slings

simple assembly of the raster on spring catches

powder coated

Enclosure material: steel

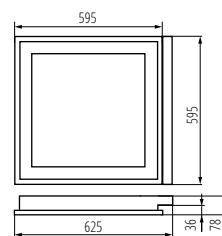

REGIS 4LED OPAL 418PT

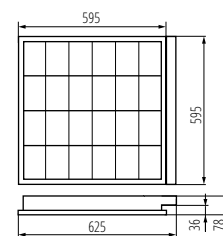

REGIS 4LED 418 PT

Kanlux NOTUS

OPRAWA RASTROWA NATYNKOWA ► CEILING LOUVER FITTING



NOTUS 3 EVG 418 NT



NOTUS 3 EVG 236 NT



NOTUS 3 EVG 218 NT



NOTUS 3 EVG 418 NT	19731	5905339197313	4 x 18	T8	G13	biały white
NOTUS 3 EVG 236 NT	19732	5905339197320	2 x 36	T8	G13	biały white
NOTUS 3 EVG 218 NT	19733	5905339197337	2 x 18	T8	G13	biały white
NOTUS 3WS EVG 418 NT	25711	5905339257116	4 x 18	T8	G13	biały white
NOTUS 3WS EVG 236 NT	25712	5905339257123	2 x 36	T8	G13	biały white

[V] 220-240 AC	[Hz] 50			IP 20		 5÷25	
	 1+2,5	EVG BALLAST	 0,5m	CE	EMC	UK CA	

AKCESORIA ► ACCESSORIES

ROPE-NT 150	07870	5905339078704	ROPE-NT 150 linka stalowa (podwójna) do zwieszania opraw, 2 szt w komplecie ROPE-NT 150 steel rope (double) for suspending fittings, 2 pcs. in a set
ROPE-NT 150 SINGLE	07871	5905339078711	ROPE-NT 150 SINGLE (pojedyncza) linka stalowa do zwieszania opraw, 2 szt w komplecie ROPE-NT 150 SINGLE steel rope (single) for suspending fittings, 2 pcs. in a set

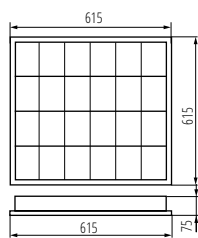

NOTUS 3 EVG 418; NOTUS 3WS EVG 418

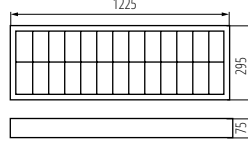

NOTUS 3 EVG 236; NOTUS 3WS EVG 236

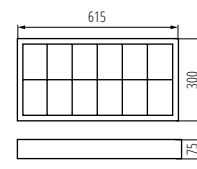

NOTUS 3 EVG 218 NT



Kanlux NOTUS to oprawy rastrowe natynkowe, które charakteryzują się łatwym i szybkim montażem. Rastry to ciągle bardzo popularne rozwiązanie oświetleniowe wnętrz biurowych czy przemysłowych. To za sprawą dobrych parametrów świetlnych przy dobrej cenie, prostej konstrukcji i odporności materiałów z jakich są wykonane.

odbłyśnik w kształcie półparaboli, poprzeczki rastra w kształcie „V”
gniazda świetlówek zamaskowane odbłyśnikiem
oprawy przystosowane do zwieszania na zawieszach
statecznik marki OSRAM w klasie A2
łatwy montaż rastra na zaczepach sprężynujących
szybkoszłączka, do podłączenia zasilania, ułatwia i przyspiesza montaż, malowanie proszkowe
NOTUS 3WS wyposażony w statecznik z „ciepłym startem”
Materiał obudowy: stal
Materiał odbłyśnika: stop aluminium

Kanlux NOTUS are raster facade luminaires that can be mounted quickly and easily. Raster lighting is still a very popular solution for office and industrial spaces. It is all due to good lighting parameters at a good price, simple construction and durability of the materials of which they are made.

half-parabolic reflector / V-shaped grille cross-bars
fluorescent lamp sockets concealed with a reflector
light fixtures designed for hanging on slings
Class A2 OSRAM ballast
easy installation of the grille on spring hooks
quick coupling for connecting the power supply, easier and quicker installation, powder coating
NOTUS 3WS equipped with a „warm start” ballast
Enclosure material: steel
Reflector material: aluminum alloy

NOTUS 4LED

OPRAWA RASTROWA NATYNKOWA ► CEILING LOUVER FITTING



NOTUS 4LED 418 NT



NOTUS 4LED 236 NT



NOTUS 4LED 218 NT



NOTUS 4LED 418 NT	22671	5905339226716	4 x max 18	T8 LED	G13	biały white
NOTUS 4LED 236 NT	22672	5905339226723	2 x max 36	T8 LED	G13	biały white
NOTUS 4LED 218 NT	22674	5905339226747	2x max 18	T8 LED	G13	biały white

[V] 220-240 AC	[Hz] 50	ONE SIDE INPUT			IP 20		 5+25
		 1+2,5	 0,5m	CE	EAC	UK	

AKCESORIA ► ACCESSORIES

ROPE-NT 150	07870	5905339078704	ROPE-NT 150 linka stalowa (podwójna) do zwieszania opraw, 2 szt w komplecie ROPE-NT 150 steel rope (double) for suspending fittings, 2 pcs. in a set
ROPE-NT 150 SINGLE	07871	5905339078711	ROPE-NT 150 SINGLE (pojedyncza) linka stalowa do zwieszania opraw, 2 szt w komplecie ROPE-NT 150 SINGLE steel rope (single) for suspending fittings, 2 pcs. in a set

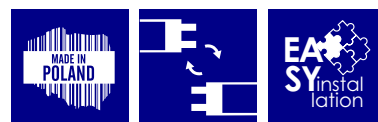

Kanlux NOTUS 4LED to oprawy rastrowe natynkowe, przystosowane do świetlówek ledowych T8. Produkowane są w Polsce, z komponentów od polskich dostawców. Rastry to rozwiązanie oświetleniowe do wnętrz biurowych i przemysłowych. Świetłówki LED przyczyniają się dodatkowo do mniejszego zużycia energii.

oprawy są przeznaczone do źródeł światła T8 LED 220-240 V -; 50/60Hz z zasilaniem jednostronnym

odbłyśnik w kształcie półparaboli, poprzeczki rastra w kształcie „V”

gniazda świetlówek zamaskowane odbłyśnikiem

oprawy przystosowane do zwieszania na zawieszach

łatwy montaż rastra na zaczepach sprężynujących

malowana proszkowo

Materiał obudowy: stal

Materiał odbłyśnika: stop aluminium

Kanlux NOTUS 4LED luminaires are façade raster luminaires adapted to T8 LED fluorescent lamps. They are manufactured in Poland of components provided by Polish suppliers. Raster lighting is a solution for office and industrial interiors. Additionally, LED fluorescent lamps contribute to lower energy consumption.

the fittings are intended for sources T8 LED 220-240 V -; 50/60 Hz with one-sided power supply

half-parabolic reflector / V-shaped grille cross-bars

fluorescent lamp sockets concealed with a reflector

light fixtures designed for handing on slings

easy installation of the grille on spring hooks

powder coating

Enclosure material: steel

Reflector material: aluminum alloy

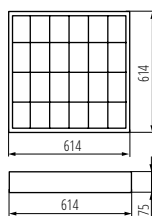

NOTUS 4LED 418 NT

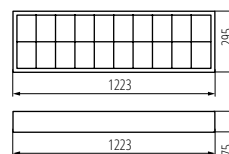

NOTUS 4LED 236 NT

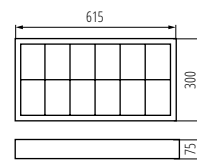

NOTUS 4LED 218 NT

Kanlux

TP STRONG

OPRAWA LINIOWA LED ► LINEAR LED LUMINAIRE



TP STRONG LED 48W-NW



TP STRONG LED 75W-NW



TP STRONG LED 90W-NW



Kanlux TP STRONG to oprawa hermetyczna do zadań specjalnych. Szczelność na poziomie IP65, odporność na uszkodzenia mechaniczne: IK08 i skuteczność świetlna: 135lm/W - to główne atuty tej oprawy. Ponadto kąt rozsyłu światła to X125°/Y110°. Parametry mówią same za siebie, a my dodajemy jeszcze 5 lat gwarancji.

5 lat Gwarancji na warunkach oświadczenia gwarancyjnego, dostępnego na stronie internetowej

Atest PZH: Numer B-BK-60212-0486/20, ważny do 2025-12-15

Materiał obudowy: tworzywo sztuczne

Materiał klosza: PC

Kanlux TP STRONG is a hermetic luminaire for special purposes. The tightness of IP65, mechanical resistance of IK08, and luminous efficacy of 135lm/W are the main advantages of this luminaire. Additionally, it has a light distribution angle of X125°/Y110°. The parameters speak for themselves, but we also give a 5-year warranty.

5 years Warranty under the terms of the warranty statement, available on our website

Enclosure material: plastic

Lampshade material: PC



Model	Code	Part No.	Power [W]	Length [mm]	Beam Angle [°]	Beam Diameter [mm]	Beam Shape	Color
TP STRONG LED 48W-NW	33170	5905339331700	48	6500	4000	X125°/Y110	biały white	
TP STRONG LED 75W-NW	33171	5905339331717	75	10000	4000	X125°/Y110	biały white	
TP STRONG LED 90W-NW	33172	5905339331724	90	12000	4000	X125°/Y110	biały white	

[V] 220-240 AC	[Hz] 50	≥300000	(h) 50000	80 ipse ≤ 6x/lockdam	Ra 80	SMD	IP 65	[-20+40]
IK 08	1,5+2,5	0,5m	CE	ERC	PZH	UK CA		

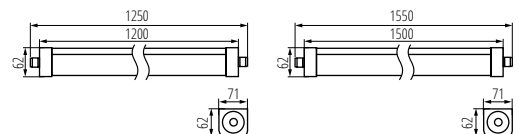

TP STRONG LED 48W

TP STRONG LED 75W; 90W

TP SLIM LED

OPRAWA LINIOWA LED ► LINEAR LED LUMINAIRE



TP SLIM LED 50W



TP SLIM LED 40W-NW



TP SLIM TW LED

Kanlux TP SLIM TW LED - oprawa okablowana przelotowo, 2 dławiki w oprawie, możliwość łączenia przelotowych opraw.
 Kanlux TP SLIM TW LED- fitting with pass-through installation, 2 chokes in the fitting, possibility of connecting the fittings in-line.



TP SLIM LED 40W-NW	27115	5905339271150	40	4400	4000	X145/Y110	biały white
TP SLIM LED 50W-NW	27116	5905339271167	50	5500	4000	X145/Y110	biały white
TP SLIM TW LED 40W-NW	27117	5905339271174	40	4400	4000	X145/Y110	biały white
TP SLIM TW LED 50W-NW	27118	5905339271181	50	5500	4000	X145/Y110	biały white

[V] 220-240 AC	[Hz] 50	 ≥20000	 25000	 Ra ≥ 80	 SMD			 IP 65	
 -20÷40	 IK 08		 1-2,5	 0,5m					



LED
techno
logy

IP
65

up to

110
lm
W

EASY
instala
tion

Kanlux TP SLIM LED to niewielka oprawa hermetyczna, którą możemy zamontować natynkowo lub w formie zwieszanej. Wygodę montażu zapewniają regulowane uchwyty i szybkozłączki. Dzięki klasie szczelności IP65 i odporności na uderzenia IK 08 mamy możliwość zastosowania oprawy w takich miejscach jak: pomieszczenia przemysłowe, magazyny, parkingi i garaże.

Materiał obudowy: tworzywo sztuczne
 Materiał klosza: tworzywo sztuczne

Kanlux TP SLIM LED is a small hermetic fitting which can be mounted on a surface or in a suspended form. Assembly is convenient thanks to adjustable holders and quick couplings. Owing to IP65 tightness class and IK 08 resistance to impact, you can use the fitting in such places as: industrial rooms, warehouses, car parks and garages.

Enclosure material: plastic
 Lampshade material: plastic

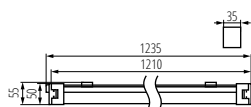

TP SLIM LED 40W-NW



TP SLIM LED 50W-NW

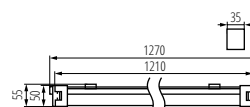

TP SLIM TW LED 40W-NW

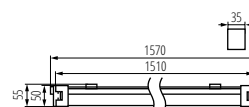

TP SLIM TW LED 50W-NW

MAH LED HI

OPRAWA PYŁOSZCZELNA LED ► LED DUSTPROOF LIGHTING FITTING



MAH LED HI 19W-NW RYF



5
WARRANTY
5 years

IP
65

up to
150 lm
W

Kanlux MAH LED HI to oprawy hermetyczne przeznaczone dla wymagających użytkowników. Cechuje je wyjątkowa skuteczność świetlna dochodząca do 150 lm/W. Kanlux MAH LED HI to także łatwy, szybki montaż i możliwość łączenia w linie - co umożliwi oświetlenie dużych powierzchni. W oprawach Kanlux MAH LED HI zastosowaliśmy ryflowany klosz, podnoszący strumień świetlny.

5 lat Gwarancji na warunkach oświadczenia gwarancyjnego, dostępnego na stronie internetowej

Atest PZH: Numer B-BK-60212-0489/20, ważny do 2025-12-15

Materiał obudowy: PC

Materiał klosza: PC

Kanlux MAH LED HI are hermetic luminaires designed for demanding users. They are characterised by exceptional luminous efficacy reaching 150 lm/W. Kanlux MAH LED HI luminaires are easy and quick to mount and can be connected in lines, enabling the illumination of large spaces. In Kanlux MAH LED HI luminaires, we used a grooved lampshade, which increases the luminous flux.

5 years Warranty under the terms of the warranty statement, available on our website

Enclosure material: PC

Lampshade material: PC



MAH LED HI 38W-NW RYF



MAH LED HI 48W-NW RYF



MAH LED HI 26W-NW RYF

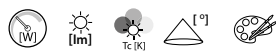

Model	Code	Part No.	Length [mm]	Power [W]	Beam Angle [°]	Beam Diameter [mm]	Color
MAH LED HI 19W-NW RYF	22606	5905339226068	19	2400	4000	110	szary grey
MAH LED HI 38W-NW RYF	22607	5905339226075	38	5000	4000	110	szary grey
MAH LED HI 48W-NW RYF	22608	5905339226082	48	6400	4000	110	szary grey
MAH LED HI 26W-NW RYF	22609	5905339226099	26	3900	4000	110	szary grey

[V] 220-240 AC	[Hz] 50	[h] ≥15000	[h] 50000	[Ra] Ra 80	[SMD] SMD	[IP] IP 65	[°C] -20+40
[IK] IK 08	[mm] 1,5+2,5	[m] 0,5m	[CE] CE	[EAC] EAC	[PZH] PZH	[UKCA] UKCA	[Down Arrow] Down Arrow

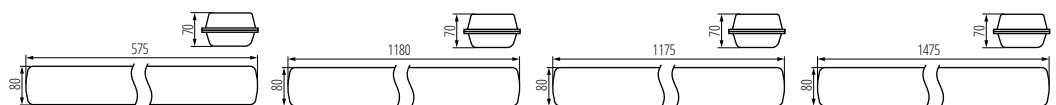

MAH LED HI 19W

MAH LED HI 26W

MAH LED HI 38W

MAH LED HI 48W

Kanlux

MAH LED N

OPRAWA PYŁOSZCZELNA LED ▶ LED DUSTPROOF LIGHTING FITTING



MAH-LED N 20W-NW/PC



MAH-LED N 40W-NW/PC



MAH-LED N 50W-NW/PC



Kanlux MAH LED N to oprawy hermetyczne przeznaczone dla bardziej wymagających użytkowników. Cechuje je wyjątkowa skuteczność świetlna dochodząca do 105 lm/W i możliwość łączenia w linie nawet 15 opraw (w zależności od modelu), co umożliwi oświetlenie dużych powierzchni.

Atest PZH: Numer B-BK-60212-0489/20, ważny do 2025-12-15

Materiał obudowy: PC

Materiał klosza: PC

Kanlux MAH LED N are hermetic luminaires designed for more demanding users. They are characterised by unique luminous efficacy reaching 105 lm/W and the possibility of connecting them in lines of even 15 luminaires (depending on the model), which allows for lighting of large spaces.

Enclosure material: PC

Lampshade material: PC



MAH-LED N 20W-NW/PC	22603	5905339226037	20	2100	4000	X135/Y100	szary grey
MAH-LED N 40W-NW/PC	22604	5905339226044	40	4200	4000	X135/Y100	szary grey
MAH-LED N 50W-NW/PC	22605	5905339226051	50	5250	4000	X135/Y100	szary grey

[V] 220-240 AC	[Hz] 50	≥15000	30000	ellipse ≤ 6x Max diam	Ra 80	SMD	IP 65	°C -20+40
IK 08	1,5+2,5	0,5m	CE	EAC	PZH	UK CA		

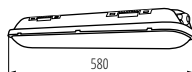

MAH-LED N 20W PC

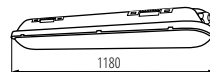

MAH-LED N 40W PC

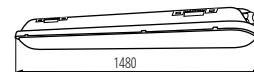

MAH-LED N 50W PC

MAH PLUS 4LED

OPRAWA PYŁOSZCZELNA POD TUBY LED
▶ DUST-PROOF LED TUBE LIGHT FITTING



MAH PLUS-236/4LED/PC



MAH PLUS-136/4LED/PC



MAH PLUS-158/4LED/PC



MAH PLUS-236/4LED/PC	22800	5905339228000	2 x max 36	T8 LED	G13	szary grey
MAH PLUS-258/4LED/PC	22801	5905339228017	2 x max 58	T8 LED	G13	szary grey
MAH PLUS-136/4LED/PC	22802	5905339228024	max 36	T8 LED	G13	szary grey
MAH PLUS-158/4LED/PC	22803	5905339228031	max 58	T8 LED	G13	szary grey

[V] 220-240 AC	[Hz] 50	IP 65	☰ 5+25	⚡ 5+25	⚙️	📏 1+2,5
ONE SIDE INPUT	0,5m	CE	ERC	PZH	CSK	🔄

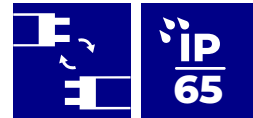

Kanlux MAH PLUS 4LED to ledowe odpowiedniki popularnych opraw. Ich głównym atutem jest fakt, że można zastosować w nich ledowe źródła światła T8 o długościach 1200 mm lub 1500 mm. Jest to doskonałe rozwiązanie dla zastosowań przemysłowych.

oprawy MAH PLUS 4LED/PC są przeznaczone do źródeł T8 LED 220-240 V-; 50/60 Hz z zasilaniem jednostronnym

Atest PZH: Numer BK/K/0024/01/2019, ważny do 2024-03-12

Materiał obudowy: tworzywo sztuczne

Materiał klosza: PC

Materiał zapinek: tworzywo sztuczne

Kanlux MAH PLUS 4LED are LED equivalents of popular luminaires. Their core asset consists in the fact that they can use T8 LED light sources that are 1200 mm or 1500 mm long. This solution is perfect for industrial use.

MAH PLUS 4 LEDs/PC light fixtures are designed for T8 LED 220-240 V-; 50/60 Hz light sources with one-sided power supply

Enclosure material: plastic

Lampshade material: PC

Clasp material: plastic

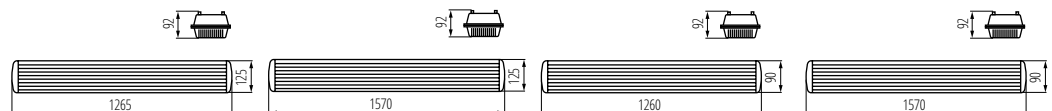

MAH PLUS-236/4LED/PC

MAH PLUS-258/4LED/PC

MAH PLUS-136/4LED/PC

MAH PLUS-158/4LED/PC

Kanlux MAH PLUS

OPRAWA PYŁOSZCZELNA ► DUSTPROOF LIGHTING FITTING



MAH PLUS-236-ABS/PC



MAH PLUS-236-ABS/PC | **18521** | 5905339185211 | 2 x 36 | T8 | G13 | szary | grey

[V] 220-240 AC	[Hz] 50			IP 65				
 1+2,5	EVG BALLAST	 0,5m		CE	EAC	UK		

AKCESORIA ► ACCESSORIES

CL-MAH PLUS	18593	5905339185938	Klipsy oprawy MAH, CL-MAH PLUS, (18593) Fitting clip MAH, CL-MAH PLUS, (18593)
CL-MAH PLUS-INOX	18594	5905339185945	Klipsy oprawy MAH, CL-MAH PLUS-INOX, (18594) Fitting clip MAH, CL-MAH PLUS-INOX, (18594)
ROPE-NT 150	07870	5905339078704	ROPE-NT 150 linka stalowa (podwójna) do zwieszania opraw, 2 szt w komplecie ROPE-NT 150 steel rope (double) for suspending fittings, 2 pcs. in a set
ROPE-NT 150 SINGLE	07871	5905339078711	ROPE-NT 150 SINGLE (pojedyncza) linka stalowa do zwieszania opraw, 2 szt w komplecie ROPE-NT 150 SINGLE steel rope (single) for suspending fittings, 2 pcs. in a set



Oprawy pyłoszczelne Kanlux MAH PLUS doskonale sprawdzają się jako oświetlenie tuneli, hal przemysłowych, garaży, pomieszczeń warsztatowych, wiat składowych lub magazynów. Wysoka klasa szczelności IP65 sprawia, że oprawy te można montować w miejscach bezpośrednio narażonych na działanie czynników atmosferycznych.

Łatwy montaż oprawy do podłoża przy użyciu dołączonych zatrzaskowych uchwytych mocujących

podwieszana płyta montażowa ułatwiająca podłączenie i serwis oprawy uszczelniający dławik, służący do wprowadzenia przewodu zasilającego

Materiał obudowy: tworzywo sztuczne

Materiał klosza: PC

Materiał zapinek: tworzywo sztuczne

Materiał uchwyty: metal

Kanlux MAH PLUS are perfect as lighting of tunnels, industrial halls, garages, workshops, storage sheds or storehouses. Owing to the high class of tightness (IP65), the luminaires can be mounted in places directly exposed to weather conditions.

easy installation of the light fixture using the supplied snap-on mounting brackets
suspended mounting plate for easier connection and maintenance of the light fixture
barrier gland for inserting a power cable

Enclosure material: plastic

Lampshade material: PC

Clasp material: plastic

Handle material: Metal

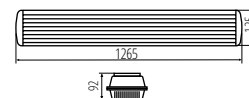

MAH PLUS-236-ABS/PC



MEBA LED IP54

OPRAWA LINIOWA LED ► LINEAR LED LUMINAIRE

NEW



MEBA LED 20W IP54 NW

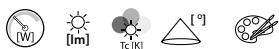

MEBA LED 20W IP54 NW	33892	5905339338921	20	2600	4000	120	biały white
MEBA LED 40W IP54 NW	33893	5905339338938	40	5200	4000	120	biały white



Kanlux MEBA LED IP54 to seria opraw natynkowych, która uzupełnia popularną rodzinę opraw Kanlux MEBA. Do wyboru mamy modele o długości 600mm i 1200mm. Kanlux MEBA LED IP54 to wysoka skuteczność świetlna, trwałość 50.000h i 5 lat gwarancji. Dodatkowym atutem tych opraw jest szczelność na poziomie IP54, i dwa przepusty kablowe, które pozwalają na łączenie przelotowe. Szybkołączka ułatwia instalację oprawy, a klosz oraz boki oprawy wykonane z poliwęglanu i baza z blachy stalowej to kolejne zalety tych opraw.

5 lat Gwarancji na warunkach oświadczenia gwarancyjnego, dostępnego na stronie internetowej

Materiał obudowy: stal

Materiał klosza: PC

Kanlux MEBA LED IP54 is a series of surface-mounted luminaires that complements the popular family of Kanlux MEBA luminaires. We can choose from models with a length of 600mm and 1200mm. Kanlux MEBA LED IP54 means high luminous efficiency, durability of 50,000 hours and a 5-year warranty. An additional advantage of these luminaires is the IP54 level and two cable entries that allow for pass-through connection. The quick connector makes it easier to install the luminaire, and the lampshade and sides of the luminaire are made of polycarbonate and the body is made of steel sheet. These are other advantages of these luminaires.

5 years Warranty under the terms of the warranty statement, available on our website

Enclosure material: steel

Lampshade material: PC

[V] 220-240 AC	[Hz] 50	[lm] ≥25000	[h] 50000	[lm] pse ≤ 60 Max/Adam	Ra 80	SMD
[°] 0,75-2	[m] 0,5m	IP 54	[°C] -20+40	[m] 0,5m	[m] 0,5m	[m] 0,5m
[m] 0,75-2	[m] 0,5m	CE	ERC	UK CA	[m] 0,5m	[m] 0,5m

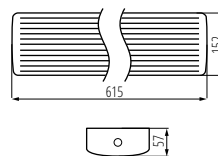

MEBA LED 20W IP54 NW

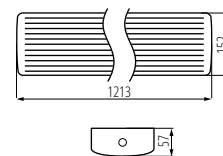

MEBA LED 40W IP54 NW

MEBA 4LED IP54

OPRAWA LINIOWA LED ► LINEAR LED LUMINAIRE

NEW



MEBA 4LED 60 IP54 PC



MEBA 4LED 60 IP54 PC	33894	5905339338945	2 x max 9	T8 LED	G13	biały white
MEBA 4LED 120 IP54 PC	33895	5905339338952	2 x max 18	T8 LED	G13	biały white
MEBA 4LED 150 IP54 PC	33896	5905339338969	2 x max 24	T8 LED	G13	biały white



Kanlux MEBA 4LED IP54 to seria opraw natynkowych z wymiennym źródłem światła, która uzupełnia popularną rodzinę opraw Kanlux MEBA. Do wyboru mamy modele o długości 600mm, 1200mm i 1500mm. Kanlux MEBA 4LED IP54 to 5 lat gwarancji i szczelność na poziomie IP54. Dwa przepusty kablowe pozwalają na łączenie przelotowe opraw. Szybkołączka ułatwia instalację oprawy, a klosz oraz boki oprawy wykonane z poliwęglanu i baza z blachy stalowej to kolejne zalety lamp Kanlux MEBA 4LED IP54.

5 lat Gwarancji na warunkach oświadczenia gwarancyjnego, dostępnego na stronie internetowej

oprawy są przeznaczone do źródeł T8 LED 220-240 V-; 50/60 Hz z zasilaniem jednostronnym

Materiał obudowy: stal

Materiał klosza: PC

Kanlux MEBA 4LED IP54 is a series of surface-mounted luminaires with a replaceable light source, which complements the popular family of Kanlux MEBA luminaires. We can choose from models with lengths of 600mm, 1200mm and 1500mm. Kanlux MEBA 4LED IP54 has a 5-year warranty and a tightness level of IP54. Two cable entries allow for pass-through connection of the luminaires. The quick connector makes it easier to install the fixture, and the lampshade and sides of the fixture are made of polycarbonate and the body is made of steel sheet - these are other advantages of the Kanlux MEBA 4LED IP54 lamps.

5 years Warranty under the terms of the warranty statement, available on our website

the fittings are intended for sources T8 LED 220-240 V-; 50/60 Hz with one-sided power supply

Enclosure material: steel

Lampshade material: PC

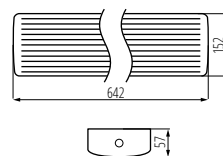

MEBA 4LED 60 IP54 PC

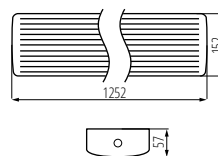

MEBA 4LED 120 IP54 PC

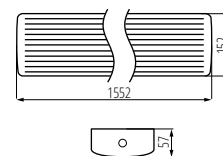

MEBA 4LED 150 IP54 PC

[V] 220-240 AC	[Hz] 50	[lm] ONE SIDE INPUT	[h] 50000	IP 54	[°C] -20+40	CE	ERC
[m] 0,75-2	[m] 0,5m	[m] 0,75-2	[m] 0,5m	[m] 0,5m	[m] 0,5m	[m] 0,5m	[m] 0,5m
[m] 0,75-2	[m] 0,5m	[m] 0,75-2	[m] 0,5m	[m] 0,5m	[m] 0,5m	[m] 0,5m	[m] 0,5m

Kanlux MEBA LED

OPRAWA LINIOWA LED ► LINEAR LED LUMINAIRE



MEBA LED 22-40W NW/WW



Kanlux MEBA LED to seria opraw natynkowych, która uzupełnia popularną rodzinę opraw Kanlux MEBA. Do wyboru mamy modele o długości 610mm (12/20W) i 1200mm (22/40W), każdy z nich to dwie moce i dwie barwy światła (3000/4000K) w jednej obudowie. Kanlux MEBA LED to wysoka skuteczność świetlna (do 125lm/W), trwałość 50.000h i 5 lat gwarancji. Dodatkowym atutem tych opraw jest trwały, ryflowany klosz z PC.

5 lat Gwarancji na warunkach oświadczenia gwarancyjnego, dostępnego na stronie internetowej

Materiał obudowy: stal

Materiał klosza: PC

Kanlux MEBA LED is a series of surface-mounted luminaires that complement the popular family of Kanlux MEBA luminaires. We have a choice of models with a length of 610mm (12 / 20W) and 1200mm (22 / 40W), each of them has two power options and two light colors options (3000 / 4000K) in one housing. Kanlux MEBA LED means high luminous efficiency (up to 125lm / W), durability of 50,000 hours and a 5-year warranty. An additional advantage of these luminaires is a durable, grooved PC diffuser.

5 years Warranty under the terms of the warranty statement, available on our website

Enclosure material: steel

Lampshade material: PC



MEBA LED 12-20W NW/WW	33890	5905339338907	12/20	1350(WW) 1500(NW) / 2200(WW) 2300(NW)	3000/4000	120	biały white
MEBA LED 22-40W NW/WW	33891	5905339338914	22/40	2500(WW) 2700(NW) / 4200(WW) 4400(NW)	3000/4000	120	biały white

[V]	[Hz]	[h]	[Ra]	[SMD]	[IP]	[°C]	[mm]	[m]	[CE]	[EAC]	[UK]	[UK]	
220-240 AC	50	≥30000	50000	≤ 6x Macadam	80	SMD	IP 20	5+25	0,75-2	0,5m	CE	EAC	UK

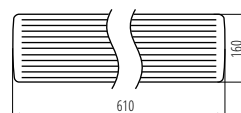

MEBA LED 12-20W NW/WW

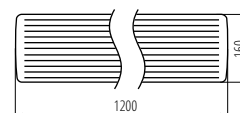

MEBA LED 22-40W NW/WW

Kanlux MEBA 4LED

OPRAWA LINIOWA POD TUBY LED T8 ► T8 LED TUBE LINEAR FITTINGS



MEBA 4LED 2X120 PS



Kanlux MEBA 4LED to ledowa wersja oprawy liniowej Kanlux MEBA. Zastosowane w niej tuby ledowe T8 gwarantują oszczędniejsze i dłuższe działanie, co pozytywnie przekłada się na ich komfort użytkowania w salonach kosmetycznych, fryzjerskich i pomieszczeniach biurowych.

oprawy są przeznaczone do źródeł T8 LED 220-240 V-; 50/60 Hz z zasilaniem jednostronnym

Materiał obudowy: tworzywo sztuczne, stal

Materiał klosza: PS

Kanlux MEBA 4LED is a LED version of Kanlux MEBA linear luminaire. T8 LED tubes used in it guarantee more economical and longer operation, which positively translates into the comfort of use in beauty and hairdresser salons, and office spaces.

the fittings are intended for sources T8 LED 220-240 V-; 50/60 Hz with one-sided power supply

Enclosure material: plastic, steel

Lampshade material: PS



MEBA 4LED 2X120 PS	26961	5905339269614	2 x max 36	T8 LED	G13	biały white
MEBA 4LED 2X120 OP PS	26964	5905339269645	2 x max 36	T8 LED	G13	biały white
MEBA 4LED 2X150 OP PS	26965	5905339269652	2 x max 58	T8 LED	G13	biały white

[V]	[Hz]	[IP]	[°C]	[mm]	[m]	[CE]	[EAC]	[UK]	[UK]
220-240 AC	50	IP 20	5+25	ONE SIDE INPUT	0,5m	CE	EAC	UK	UK

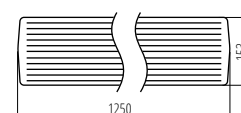

MEBA 4LED 2X120

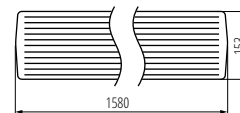

MEBA 4LED 2X150

ALDO 4LED

OPRAWA LINIOWA POD TUBY LED T8 ► T8 LED TUBE LINEAR FITTINGS



ALDO 4LED 1X60; 1X120; 1X150



ALDO 4LED 1X120



ALDO 4LED 1X150



ALDO 4LED 2X120



ALDO 4LED 1X60	26360	5905339263605	max 18	T8 LED	G13	biały white
ALDO 4LED 1X120	26361	5905339263612	max 36	T8 LED	G13	biały white
ALDO 4LED 1X150	26362	5905339263629	max 58	T8 LED	G13	biały white
ALDO 4LED 2X120	26364	5905339263643	2 x max 36	T8 LED	G13	biały white
ALDO 4LED 2X150	26365	5905339263650	2 x max 58	T8 LED	G13	biały white

[V] 220-240 AC	[Hz] 50			IP 20		 5÷25	
	 0,5-2,5	 L N PE ONE SIDE INPUT	 0,5m	CE	EAC	UK CA	

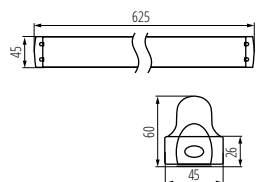

ALDO 4LED 1X60

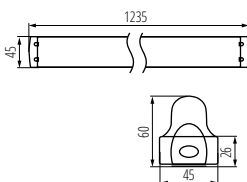

ALDO 4LED 1X120

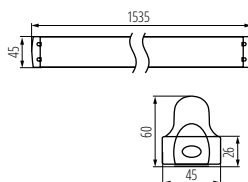

ALDO 4LED 1X150

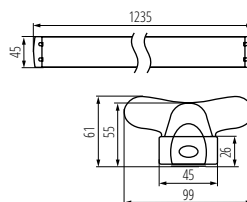

ALDO 4LED 2X120; 2X120R

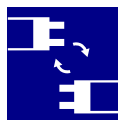

Kanlux ALDO 4LED to rodzina belek oświetleniowych przystosowanych do świetlówek ledowych T8. Są to oprawy ścienny-sufitowe charakteryzujące się nowoczesnym, opływowym kształtem, przez co dyskretnie wpasują się w każdą aranżację wnętrza.

Oprawy są przeznaczone do źródeł T8 LED 220-240 V-; 50/60 Hz z zasilaniem jednostronnym

Materiał obudowy: metal, tworzywo sztuczne

Kanlux ALDO 4LED are a family of batten luminaires adapted to T8 LED fluorescent lamps. They are wall and ceiling luminaires characterised by modern, streamlined shape so they fit discreetly in each interior arrangement.

The fittings are intended for sources T8 LED 220-240 V-; 50/60 Hz with one-sided power supply

Enclosure material: Metal, plastic

ALDO 4LED

OPRAWA LINIOWA POD TUBY LED T8 ► T8 LED TUBE LINEAR FITTINGS

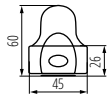

ALDO 4LED 1X60

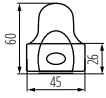
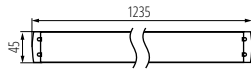

ALDO 4LED 1X120

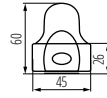
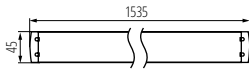

ALDO 4LED 1X150

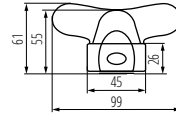
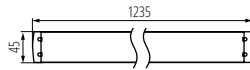

ALDO 4LED 2X120

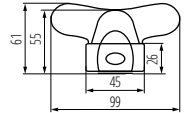

ALDO 4LED 2X150



IPER LED

PLAFONIERA LED ► CEILING-MOUNTED LED LIGHT FITTING



IPER LED 10W-NW-O



Model	Code	Power [W]	Beam Angle [°]	Light Output [lm]	Temp [K]	Color	Notes
IPER LED 10W-NW-O	37290	5905339372901	10	1200	4000	biały white	
IPER LED 19W-NW-O	37291	5905339372918	19	2280	4000	biały white	
IPER LED 26W-NW-O	37292	5905339372925	26	3120	4000	biały white	
IPER LED 35W-NW-O	37293	5905339372932	35	4200	4000	biały white	
IPER LED 10W-NW-L	37294	5905339372949	10	1200	4000	biały white	
IPER LED 19W-NW-L	37295	5905339372956	19	2280	4000	biały white	
IPER LED 26W-NW-L	37296	5905339372963	26	3120	4000	biały white	
IPER LED 35W-NW-L	37297	5905339372970	35	4200	4000	biały white	
IPER LED 10W-NW-O-SE	37298	5905339372987	10	1200	4000	biały white	mikrofalowy microwave
IPER LED 19W-NW-O-SE	37299	5905339372994	19	2280	4000	biały white	mikrofalowy microwave
IPER LED 26W-NW-O-SE	37300	5905339373007	26	3120	4000	biały white	mikrofalowy microwave
IPER LED 35W-NW-O-SE	37301	5905339373014	35	4200	4000	biały white	mikrofalowy microwave
IPER LED 10W-NW-L-SE	37302	5905339373021	10	1200	4000	biały white	mikrofalowy microwave
IPER LED 19W-NW-L-SE	37303	5905339373038	19	2280	4000	biały white	mikrofalowy microwave
IPER LED 26W-NW-L-SE	37304	5905339373045	26	3120	4000	biały white	mikrofalowy microwave
IPER LED 35W-NW-L-SE	37305	5905339373052	35	4200	4000	biały white	mikrofalowy microwave

[V]	[Hz]	[°]	[h]	[h]	[Ra]
220-240 AC	50	120	≥50000	50000	80
Hg	SMD	IP65	IP65	IP65	-20+40
IK10	1,5	0,5m	CE	ERC	
UK CA					



Plafoniera Kanlux IPER LED to szereg zalet, które wpływają na jej jakość. 5 lat gwarancji, trwałość 50 000h, wysoka skuteczność świetlna 120lm/W - to tylko część z nich. Plafonierey Kanlux IPER LED oparliśmy o komponenty renomowanych producentów jak diody LED Samsung 2835. Ponadto te oprawy cechuje wyjątkowa odporność na wnikanie wody i ciał stałych IP65 oraz najwyższa odporność mechaniczna IK10, a dzięki temu zastosujesz tę plafonierę w każdym możliwym miejscu wewnątrz i na zewnątrz. Aby dopasować ją do każdej sytuacji i miejsca do wyboru są: dwa kształty oprawy, cztery moce i możliwość wyboru opraw z mikrofalowym czujnikiem ruchu (modele SE).

5 lat Gwarancji na warunkach oświadczenia gwarancyjnego, dostępnego na stronie internetowej

Materiał obudowy: tworzywo sztuczne

Materiał klosza: tworzywo sztuczne

The Kanlux IPER LED ceiling fixture has a number of advantages that affect its quality. 5-year warranty, durability 50,000 hours, high luminous efficiency of 120lm/W - these are just some of them. Kanlux IPER LED ceiling lamps are based on components from renowned manufacturers, such as Samsung 2835 LEDs. Moreover, these lamps are characterized by exceptional resistance to the ingress of water and dust IP65 and the highest mechanical resistance IK10 ("vandal proof"), thanks to which you can use this ceiling lamp in every possible place inside and outside. To adapt it to every situation and place, you can choose from: two luminaire shapes, four powers and the option of choosing luminaires with a microwave motion sensor (SE models).

5 years Warranty under the terms of the warranty statement, available on our website

Enclosure material: plastic

Lampshade material: plastic

IPER LED

PLAFONIERA LED ► CEILING-MOUNTED LED LIGHT FITTING



IPER LED 10W-NW-O



IPER LED 19W-NW-O



IPER LED 26W-NW-O



IPER LED 35W-NW-O



IPER LED 10W-NW-L



IPER LED 19W-NW-L



IPER LED 26W-NW-L



IPER LED 35W-NW-L

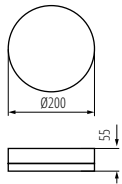

IPER LED 10W-NW-O

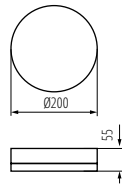

IPER LED 19W-NW-O

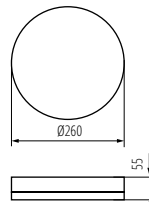

IPER LED 26W-NW-O

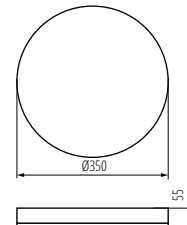

IPER LED 35W-NW-O

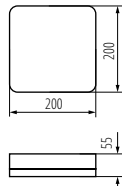

IPER LED 10W-NW-L

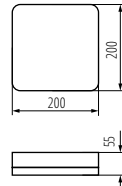

IPER LED 19W-NW-L

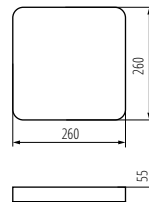

IPER LED 26W-NW-L

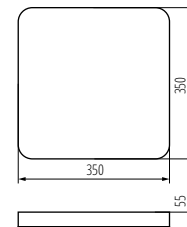

IPER LED 35W-NW-L



BENO LED

PLAFONIERA LED ► CEILING-MOUNTED LED LIGHT FITTING



BENO 18W L-GR; BENO 18W L-SE GR



BENO 18W O-W; BENO 18W O-SE W



BENO 18W O-GR; BENO 18W O-SE GR



BENO 18W L-W; BENO 18W L-SE W



BENO 18W L-GR; BENO 18W L-SE GR



BENO 24W O-W; BENO 24W O-SE W



BENO 24W O-GR; BENO 24W O-SE GR



BENO 24W L-W; BENO 24W L-SE W



BENO 24W L-GR; BENO 24W L-SE GR



Oprawy Kanlux BENO to unikatowa konstrukcja i wyjątkowy efekt świetlny. Zostały stworzone przez projektantów Kanlux, dlatego ich wzory zostały przez nas zastrzeżone w urzędzie patentowym. Kanlux BENO LED to wysoka odporność na warunki atmosferyczne - dlatego możemy stosować je wewnątrz domu jak i na zewnątrz. To również szybki i łatwy montaż na suficie lub ścianie oraz czujnik ruchu (w wersjach -SE) z możliwością regulacji. Kanlux BENO LED jest oprawą multifunkcyjną, którą ze względu na jej aspekty techniczne, możemy zastosować praktycznie w każdym miejscu. Ponadto jej design jest unikatowy i stanie się ona ozdobą każdego miejsca, w którym ją umieścimy.

Materiał obudowy: tworzywo sztuczne

Materiał klosza: tworzywo sztuczne

Kanlux BENO luminaires that's unique design and unique light effect. They were created on the basis of individual order of Kanlux, and their designs were registered by us at the patent office. Kanlux BENO LED also provides high weather resistance (IP54), quick and easy installation on the ceiling or wall, and BENO is equipped with the adjustable movement sensor (in versions -SE). Kanlux BENO LED is a multifunctional fitting, which due to its design and its technical aspects, we can apply practically anywhere.

Enclosure material: plastic

Lampshade material: plastic

BENO LED

PLAFONIERA LED ▶ CEILING-MOUNTED LED LIGHT FITTING



BENO 24W O-W, BENO 24W O-SE W



BENO 18W NW-O-W	32940	5905339329400	18	1550	4000	biały white	
BENO 18W NW-L-W	32942	5905339329424	18	1550	4000	biały white	
BENO 18W NW-O-SE W	32944	5905339329448	18	1550	4000	biały white	mikrofalowy microwave
BENO 18W NW-L-SE W	32946	5905339329462	18	1550	4000	biały white	mikrofalowy microwave
BENO N 18W NW-O-SE GR	32948	5905339329486	18	1400	4000	grafitowy graphite	mikrofalowy microwave
BENO N 18W NW-L-SE GR	32949	5905339329493	18	1400	4000	grafitowy graphite	mikrofalowy microwave
BENO N 18W NW-O-GR	33348	5905339333483	18	1400	4000	grafitowy graphite	
BENO N 18W NW-L-GR	33349	5905339333490	18	1400	4000	grafitowy graphite	
BENO 24W NW-O-W	33340	5905339333407	24	2060	4000	biały white	
BENO 24W NW-O-GR	33341	5905339333414	24	1920	4000	grafitowy graphite	
BENO 24W NW-L-W	33342	5905339333421	24	2060	4000	biały white	
BENO 24W NW-L-GR	33343	5905339333438	24	1920	4000	grafitowy graphite	
BENO 24W NW-O-SE W	33344	5905339333445	24	2060	4000	biały white	mikrofalowy microwave
BENO 24W NW-O-SE GR	33345	5905339333452	24	1920	4000	grafitowy graphite	mikrofalowy microwave
BENO 24W NW-L-SE W	33346	5905339333469	24	2060	4000	biały white	mikrofalowy microwave
BENO 24W NW-L-SE GR	33347	5905339333476	24	1920	4000	grafitowy graphite	mikrofalowy microwave



[V] 220-240 AC	[Hz] 50	[°] 110	[lm] ≥20000	[h] 20000	[lm] ≤60 Mac/klm	Ra 80	Hg	SMD		
IP 54		[°C] -15+35			[mm] 0,5+1,5	0,5m	CE	ERC	UK CA	

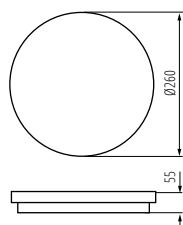

BENO 18W O

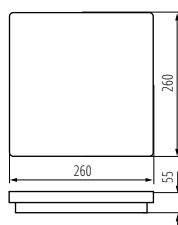

BENO 18W L

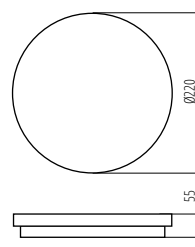

BENO 24W O

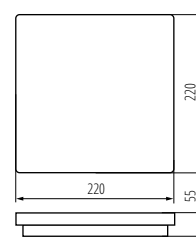

BENO 24W L

VARSO LED

PLAFONIERA LED ► CEILING-MOUNTED LED LIGHT FITTING



VARSO LED 18W-O; VARSO LED 18W-O-SE



VARSO LED 18W-O; VARSO LED 18W-O-SE



VARSO LED 18W-L; VARSO LED 18W-L-SE



VARSO LED 24W-O; VARSO LED 24W-O-SE
VARSO HI 36W-NW-O; VARSO HI 36W-NW-O-SE



VARSO LED 24W-L; VARSO LED 24W-L-SE
VARSO HI 36W-NW-L



VARSO LED 18W-WW-O	26440	5905339264404	18	1620	3000	biały white	
VARSO LED 18W-NW-O	26441	5905339264411	18	1700	4000	biały white	
VARSO LED 18W-NW-L	26443	5905339264435	18	1700	4000	biały white	
VARSO LED 24W-WW-O	26444	5905339264442	24	2160	3000	biały white	
VARSO LED 24W-NW-O	26445	5905339264459	24	2280	4000	biały white	
VARSO LED 24W-NW-L	26447	5905339264473	24	2280	4000	biały white	
VARSO HI 36W-NW-O	26448	5905339264480	36	3600	4000	biały white	
VARSO HI 36W-NW-L	26449	5905339264497	36	3600	4000	biały white	
VARSO LED 18W-NW-L-SE	26980	5905339269805	18	1700	4000	biały white	mikrofalowy microwave
VARSO LED 18W-NW-O-SE	26981	5905339269812	18	1700	4000	biały white	mikrofalowy microwave
VARSO LED 24W-NW-L-SE	26983	5905339269836	24	2280	4000	biały white	mikrofalowy microwave
VARSO LED 24W-NW-O-SE	26984	5905339269843	24	2280	4000	biały white	mikrofalowy microwave
VARSO HI 36W-NW-O-SE	26985	5905339269850	36	3600	4000	biały white	mikrofalowy microwave

[V]	[Hz]	[°]	[h]	[h]	ellipse	Ra	Hg	SMD		IP
220-240 AC	50	120	≥20000	20000	≤ 6x Maczka	80				54
	[°C]	[mm]	[mm]	[m]	360°		CE	EAC	PZH	UK
	-20+35		0,5-2,5	0,5m	Φuse				CA	

Kanlux

VARSO LED

PLAFONIERA LED ► CEILING-MOUNTED LED LIGHT FITTING



Kanlux VARSO LED to rodzina plafonier hermetycznych ze zintegrowanym źródłem światła LED. Jest to znakomita propozycja zarówno dla inwestycji (spółdzielnie mieszkaniowe, hotele) jak i indywidualnych gospodarstw domowych gdzie potrzebna jest podwyższona odporność na wilgoć (IP54). Dla oświetlenia szczególnie dużych powierzchni proponujemy Kanlux VARSO HI o mocy 36 watów, których strumień świetlny wynosi aż 3600 lumenów. Pamiętaj, że dostępne są również wersje Kanlux VARSO z czujnikami ruchu (SE).

VARSO LED + SE - wersja z czujnikiem ruchu

Atest PZH: Numer BK/K/0352/01/2018, ważny do 30.05.2023 - VARSO LED 18W, 24W

Atest PZH: Numer B.BK.60112.0028.2022, ważny do 11.03.2027 - VARSO HI 36W

Materiał obudowy: tworzywo sztuczne

Materiał klosza: tworzywo sztuczne

Kanlux VARSO LED is a family of hermetic ceiling light fixtures with an integrated LED light source. It is a great choice both for developments (housing co-operatives, hotels) and individual households where increased resistance to humidity (IP54) is needed. For lighting particularly large spaces, we recommend 36W Kanlux VARSO HI with a luminous flux up to 3600 lm. Keep in mind that we also offer Kanlux VARSO fixtures with motion sensors (SE).

VARSO LED + SE - version with a motion sensor

Enclosure material: plastic

Lampshade material: plastic

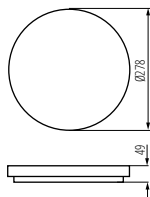

VARSO LED 18W-0

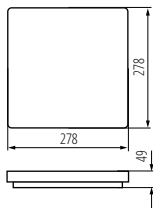

VARSO LED 18W-L

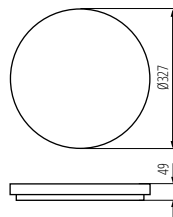

VARSO LED 24W 0, VARSO HI 36W 0

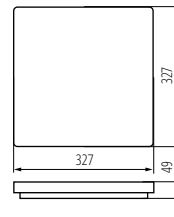

VARSO LED 24W L, VARSO HI 36W L



STIVI LED

PLAFONIERA LED ► CEILING-MOUNTED LED LIGHT FITTING



STIVI LED 24W-NW-O, STIVI LED 24W-NW-O-SE



STIVI LED 24W-NW-O, STIVI LED 24W-NW-O-SE STIVI LED 36W-NW-O, STIVI LED 36W-NW-O-SE



Plafoniera Kanlux STIVI LED zapewni nam światło tam, gdzie standardowe oprawy oświetleniowe mogą zawieść. Charakteryzuje ją wysoka skuteczność świetlna-130lm/W, wysoki stopień szczelności - IP65 i odporność na uszkodzenia IK08. Oprawę Kanlux STIVI LED możemy zastosować na zewnątrz (balkony, tarasy, patio, otwarte altany), na korytarzach i klatkach schodowych, a także w miejscach gdzie panuje podwyższona wilgotność (pralnie, przebieralnie i ciągi komunikacyjne na basenach). Dodatkowymi zaletami jest: 5 lat gwarancji i 50.000 godzin trwałości źródła światła w oprawie, a także możliwość wyboru wersji z czujnikiem ruchu. Polecamy ją jako wysokiej klasy produkt inwestycyjny lub do profesjonalnych zastosowań domowych.

5 lat gwarancji na warunkach oświadczenia gwarancyjnego, dostępnego na stronie internetowej

Materiał obudowy: PC

Materiał klosza: PC

The Kanlux STIVI LED ceiling light will provide you with lighting where standard luminaires may fail. It is characterised by high luminous efficacy of 130lm/W, a high level of protection - IP65 and impact protection rating of IK08. Kanlux STIVI LED luminaire can be used outdoors (on balconies, terraces, patios, open arbours), in corridors and staircases, as well as in places with increased humidity (laundry rooms, changing rooms and passageways at swimming pools). Additional advantages include: 5-year warranty and 50,000 hours of light source life in the luminaire, as well as the option of choosing a version with a motion sensor. We recommend it as a high-end investment product or for professional domestic use.

5 years Warranty under the terms of the warranty statement, available on our website

Enclosure material: PC

Lampshade material: PC



STIVI LED 24W-NW-O	35000	5905339350008	24	3120	4000	biały white
STIVI LED 24W-NW-O-SE	35001	5905339350015	24	3120	4000	biały white mikrofalowy microwave
STIVI LED 36W-NW-O	35002	5905339350022	36	4680	4000	biały white
STIVI LED 36W-NW-O-SE	35003	5905339350039	36	4680	4000	biały white mikrofalowy microwave

[V]	[Hz]	[°]	[h]	[h]	ellipse	Ra	Hg	SMD	IP	house
220-240 AC	50	110	≥30000	50000	≤ 6x Max/dam	80			65	
[-20+40]	IK 08		0,5-2,5	0,5m	360°	CE	ERL	UKA		

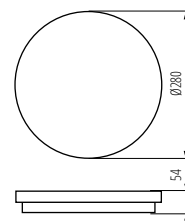

STIVI LED 24W

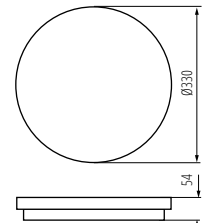

STIVI LED 36W

Kanlux

ORTE LED

PLAFONIERA LED ▶ CEILING-MOUNTED LED LIGHT FITTING



ORTE LED 18W-NW-O



ORTE LED 18W-O, ORTE LED 18W-O-SE

ORTE LED 24W



Kanlux ORTE LED to nowa rodzina plafonier gdzie szczególną uwagę zwróciliśmy na design i łatwość instalacji. Dla dodatkowej wygody proponujemy Wam również wersje z czujnikiem ruchu.

Materiał obudowy: tworzywo sztuczne
Materiał klosza: tworzywo sztuczne



Kanlux ORTE LED is a new family of wall and ceiling fixtures in which particular attention has been paid to design and ease of installation. For added convenience, you can also choose from various motion detector versions.



Enclosure material: plastic
Lampshade material: plastic



ORTE LED 18W-NW-O	29160	5905339291608	18	1600	4000	biały white
ORTE LED 24W-NW-O	29161	5905339291615	24	2200	4000	biały white
ORTE LED 18W-NW-O-SE	29162	5905339291622	18	1600	4000	biały white mikrofalowy microwave
ORTE LED 24W-NW-O-SE	29163	5905339291639	24	2200	4000	biały white mikrofalowy microwave

[V] 220-240 AC	[Hz] 50	[°] 120	[h] ≥20000	[h] 20000	ellipse ≤6x MacKadam	Ra 80	Hg	SMD	RoHS	REACH
IP 54	°C -20÷35	mm 0,75±2,5	mm 0,5m	CE	EAC	UK CA	Recycling			

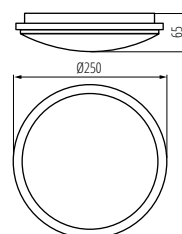

ORTE LED 18W

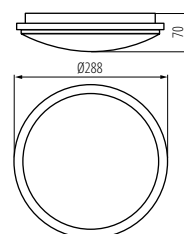

ORTE LED 24W

Kanlux DABA PRO

PLAFONIERA LED ► CEILING-MOUNTED LED LIGHT FITTING



DABA PRO 25W NW-B



DABA PRO 25W NW-B	19065	5905339190659	25	2800	4000	czarny black
DABA PRO 26W NW-SE-W	19066	5905339190666	26	2800	4000	biały white mikrofalowy microwave

[V] 220-240 AC	[Hz] 50	[°] 115	[lm] ≥25000	[h] 50000	ellipse ≤ 6x MacAdam	Ra 80	Hg	SMD	IP 65	[-20+40]	IK 10	[mm] 0,75-2,5	[m] 0,5m	[lm] P _{out} 24	[lm] Φ _{use} 3600	CE
ERC	UK CA															



Kanlux DABA PRO to plafonierzy do zastosowań profesjonalnych. Do wyboru mamy wersję bez czujnika ruchu (25W) oraz z czujnikiem (26W) i dwa kolory obudowy - biały i czarny. Kanlux DABA PRO to szczelność IP65 i wysoka wytrzymałość na warunki atmosferyczne, a także odporność na uszkodzenia mechaniczne IK10 i dodatkowe zabezpieczenie oprawy przed otwarciem. Plafonierzy Kanlux DABA PRO można łączyć ze sobą na zasadzie MASTER → SLAVE, tzn. pierwsza (pierwsza i ostatnia) oprawa posiadająca czujnik steruje ciągiem opraw. Wysoka jakość wykonania plafonier Kanlux DABA PRO potwierdzona jest 5 letnią gwarancją.

5 lat Gwarancji na warunkach oświadczenia gwarancyjnego, dostępnego na stronie internetowej

Materiał obudowy: tworzywo sztuczne
Materiał klosza: PC

Kanlux DABA PRO are ceiling lamps for professional use. We can choose a version without a motion sensor (25W) and with a sensor (26W) and two housing colors - white and black. Kanlux DABA PRO means IP65 tightness and high resistance to weather conditions, as well as resistance to mechanical damage IK10 and additional protection of the luminaire against opening. Kanlux DABA PRO plafonds can be combined with each other on the MASTER → SLAVE principle, i.e. the first (first and last) luminaire with a sensor controls the series of luminaires. The high quality of Kanlux DABA PRO ceiling fixtures is confirmed by a 5-year warranty.

5 years Warranty under the terms of the warranty statement, available on our website

Enclosure material: plastic
Lampshade material: PC

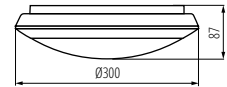

DABA PRO 25W

Kanlux DABA N LED SMD

PLAFONIERA LED ► CEILING-MOUNTED LED LIGHT FITTING



DABA N LED SMD DL-16W



DABA N LED SMD DL-16W	19062	5905339190628	16	1300	4000	biały white mikrofalowy microwave
-----------------------	--------------	---------------	----	------	------	---------------------------------------

[V] 220-240 AC	[Hz] 50	[°] 120	[lm] ≥20000	[h] 40000	ellipse ≤ 6x MacAdam	Ra 80	Hg	SMD	IP 66	[-15+35]	IK 10	[mm] 0,75-2,5	[m] max 8	[lm] P _{out} H360	



Energooszczędna oprawa Kanlux DABA N daje możliwość zmniejszenia kosztów zużycia energii, dzięki zastosowanym czujnikom ruchu i zmierzchu. To powoduje, że świeci ona tylko wtedy gdy jest to konieczne. Ponadto jej parametry (IP66, IK10) sprawiają, że można ją zamontować praktycznie w każdym miejscu! Funkcja STAND BY DIMMING sprawia, że po zaprogramowanym czasie przy braku ruchu, plafoniera wchodzi w tryb czuwania i zmniejsza strumień świetlny do 20%.

Atest PZH: Numer BK/K/0352/02/2018, ważny do 2023-05-30

Materiał obudowy: PC
Materiał klosza: PC

Kanlux DABA N is an energy-efficient luminaire allows for decreasing energy consumption costs due to the use of motion detectors and dusk-to-dawn sensors. Therefore, it emits light only when it is necessary. Moreover, its parameters (IP66, IK10) allow for mounting it in almost every place! The ceiling luminaire enters standby mode and decreases the luminous flux to 20% after the pre-set time in the absence of motion using the STAND BY DIMMING function.

Enclosure material: PC
Lampshade material: PC



DABA N LED SMD DL-16W

TYBIA LED

PLAFONIERA LED ▶ CEILING-MOUNTED LED LIGHT FITTING



TYBIA LED 38W-NW



TYBIA LED 38W GY, SE



TYBIA LED 28W GY, SE



TYBIA LED 38W B, SE



TYBIA LED 28W B, SE



Kanlux TYBIA LED to oprawa oświetlenia ogólnego, w której zastosowano diody SMD. Montaż oprawy TYBIA LED w korytarzach, klatkach schodowych, pokojach socjalnych czy gospodarczych, gwarantuje znaczne oszczędności nie tylko związane z poborem energii ale także jej długoterminową, bezobsługową eksploatacją.

5 lat gwarancji na warunkach oświadczenia gwarancyjnego, dostępnego na stronie internetowej

Materiał obudowy: stop aluminium

Materiał klosza: PMMA

Kanlux TYBIA LED is a general lighting luminaire using SMD diodes. When mounted in corridors, staircases, social or utility rooms, TYBIA LED allows for significant savings related to both reduced energy consumption and the long-term maintenance-free operation.

5 years Warranty under the terms of the warranty statement, available on our website

Enclosure material: aluminum alloy

Lampshade material: PMMA



TYBIA LED 38W-NW	24640	5905339246400	38	3800	4000	szary / biały grey / white	≥20000
TYBIA LED 38W-NW-SE	24641	5905339246417	38	3800	4000	szary / biały grey / white	mikrofalowy microwave ≥20000
TYBIA LED 38W-NW B	24642	5905339246424	38	3800	4000	czarny black	≥20000
TYBIA LED 38W-NW-SE B	24643	5905339246431	38	3800	4000	czarny black	mikrofalowy microwave ≥20000
TYBIA M 25W-NW GY	24644	5905339246448	25	2600	4000	szary grey	≥15000
TYBIA M 25W-NW B	24645	5905339246455	25	2600	4000	czarny black	≥15000
TYBIA M 25W-NW-SE GY	24646	5905339246462	25	2600	4000	szary grey	mikrofalowy microwave ≥15000
TYBIA M 25W-NW-SE B	24647	5905339246479	25	2600	4000	czarny black	mikrofalowy microwave ≥15000

[V] 220-240 AC	[Hz] 50	[°] 110	[h] 30000	Ra 80	Hg	SMD	IP 20
🏠	🌡️ 5+25	⬆️	📦	📏 1-2,5	📏 0,5m	CE	EAC
						UK	CA

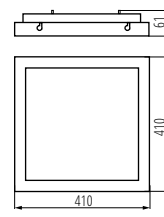

TYBIA LED 38W

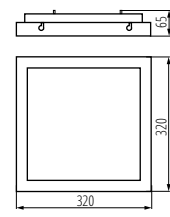

TYBIA LED 25W

Kanlux

JURBA DL

PLAFONIERA Z WYMIENNYM ŹRÓDŁEM ŚWIATŁA

▶ CEILING-MOUNTED LIGHT FITTING WITH REPLACEABLE LIGHT SOURCE



JURBA DL-2180



Plafoniera hermetyczna Kanlux JURBA to doskonała jakość wykonania. Oprawę można montować zarówno na ścianie jak i na suficie, wewnątrz i na zewnątrz budynków. Podwyższona szczelność IP44 opraw Kanlux JURBA chroni je przed kurzem, pyłem i wilgocią.

Materiał obudowy: stal

Materiał klosza: PC

Kanlux JURBA is a hermetic ceiling light fixture of excellent workmanship. The fixture can be mounted both on ceilings and on walls, indoors and outdoors. The increased protection rating IP44 of Kanlux JURBA luminaires protects them from dust, particles and moisture.

Enclosure material: steel

Lampshade material: PC



JURBA DL-2180



JURBA DL-218L



JURBA DL-2180	08980	5905339089809	2 x max 18	CFL/LED	E27	nikiel satynowy nickel satin
JURBA DL-218L	08981	5905339089816	2 x max 18	CFL/LED	E27	nikiel satynowy nickel satin

[V] 220-240 AC	[Hz] 50	IP 44	°C -10+35	UK CA
mm 1-2,5	m 0,1m	CE	ERC	UK CA

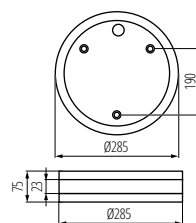

JURBA DL-2180

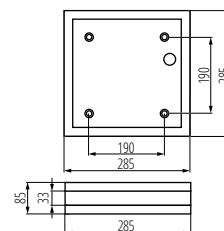

JURBA DL-218L

PIRES DL

PLAFONIERA Z WYMIENNYM ŹRÓDŁEM ŚWIATŁA

► CEILING-MOUNTED LIGHT FITTING WITH REPLACEABLE LIGHT SOURCE



PIRES DL-600



PIRES DL-600 NS



PIRES ECO DL-250



PIRES ECO DL-250 NS



Kanlux PIRES to plafoniera o minimalistycznym wyglądzie, którą dzięki stopniowi szczelności IP44 zastosujemy również na zewnątrz. Dla większego komfortu proponujemy Wam również wersje wyposażone w mikrofalowy czujnik ruchu (kod 19000 i 8810), którego zasięg wynosi 9 metrów.

wersja PIRES DL-60 NS, PIRES ECO DL-250 NS - bez czujnika ruchu
wyposażona w mikrofalowy czujnik ruchu (8810, 19000)
maksymalny horyzontalny kąt działania czujnika ruchu wynoszący 360°
maksymalny wertykalny kąt działania czujnika ruchu wynoszący 140°
możliwość regulacji czasu świecenia od 8s do 12min
maksymalny zasięg wykrywania ruchu wynoszący 9m
wykrywanie ruchu 0.3...3m/s (1...10km/h), regulacja zużycia w zakresie 2...2000lx

Materiał obudowy: tworzywo sztuczne

Kanlux PIRES is a ceiling light fixture with minimalistic appearance which can be used outside too thanks to IP44 degree of tightness. To increase comfort, we also propose versions equipped with a microwave motion detector (code 19000 and 8810) the range of which comes to 9 metres.

PIRES DL-60 NS, PIRES ECO DL-250 NS version - without motion sensor
provided with a MW motion sensor (8810, 19000)
maximum horizontal adjustment range for the motion sensor: 360°
maximum vertical motion sensor angle: 140°
lighting time adjustable in the range of 8 s to 12 min
maximum motion detection range: 9 m
motion detection 0.3...3 m/s (1...10 km/h), sensitivity adjustment range: 2...2,000 lx
Enclosure material: plastic



Materiał klosza



Model	Kod	Art. nr	Wysokość	Źródło światła	Wtyk	Materiał klosza	Kolor	Wyposażenie
PIRES DL-600	08810	5905339088109	max 60	GLS/CFL/LED	E27	szkło glass	biały white	mikrofalowy microwave
PIRES DL-600 NS	08811	5905339088116	max 60	GLS/CFL/LED	E27	szkło glass	biały white	
PIRES ECO DL-250	19000	5905339190000	max 25	CFL/LED	E27	tworzywo sztuczne plastic	biały white	mikrofalowy microwave
PIRES ECO DL-250 NS	19001	5905339190017	max 25	CFL/LED	E27	tworzywo sztuczne plastic	biały white	

220-240 AC	50	IP 44		5+35		
1-2,5	0,5m					

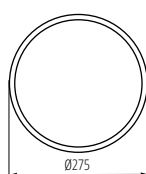

PIRES DL-600

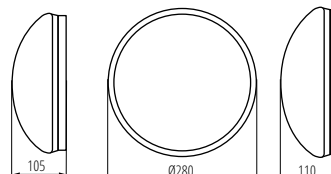

PIRES DL-600 NS

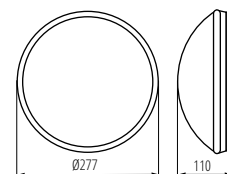

PIRES ECO DL-250; PIRES ECO DL-250 NS

Kanlux

FOGLER LED

PLAFONIERA LED ► CEILING-MOUNTED LED LIGHT FITTING



FOGLER LED 14W-NW



FOGLER LED 14W-NW | 18121 | 5905339181213 | 14 | 800 | 4000 | biały | white | PIR

[V] 220-240 AC	[Hz] 50	[°] 110	[lx] ≥15000	[h] 20000	[lx] ≤6lx Max/dam	Ra 80	SMD	0,5m	Im W 57	IP 20	5+25
[m] 0,5-2,5	[m] max 6	[s] - [min] 360	[lx] 10-5	[lx] 5-2000	[m] 0,5m	CE	EAC	UK	CA		



Plafoniera Kanlux FOGLER LED z czujnikiem ruchu, znakomicie sprawdzi się przy oświetleniu klatek schodowych, pomieszczeń technicznych w budynkach wielorodzinnych, schowków, piwnic, a także garaży i podjazdów w domach jednorodzinnych.

Materiał obudowy: stal
Materiał klosza: PC

Kanlux FOGLER LED ceiling light fixture with motion detector is a great solution for lighting staircases, technical rooms in multi-family buildings, storage rooms, basements, garages and driveways in detached houses.

Enclosure material: steel
Lampshade material: PC

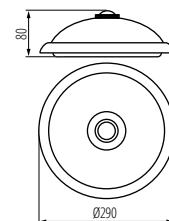

FOGLER LED 14W-NW

Kanlux

FOGLER DL

PLAFONIERA Z WYMIENNYM ŹRÓDŁEM ŚWIATŁA ► CEILING-MOUNTED LIGHT FITTING WITH REPLACEABLE LIGHT SOURCE



FOGLER DL-2400



FOGLER DL-2400 | 18120 | 5905339181206 | 2 x max 40 | GLS/CFL/LED | E27 | biały | white

[V] 220-240 AC	[Hz] 50	[°] 110	[lx] ≥15000	[h] 20000	[lx] ≤6lx Max/dam	Ra 80	SMD	0,5m	Im W 57	IP 20	5+25
[m] 0,5-2,5	[m] max 6	[s] - [min] 360	[lx] 10-5	[lx] 5-2000	[m] 0,5m	CE	EAC	UK	CA		



Plafoniera Kanlux FOGLER DL z wymiennym źródłem światła doskonale sprawdzi się na klatkach schodowych, piwnicach, strychach i innych tego typu pomieszczeń. Wbudowany czujnik z maksymalnym kątem (360°) wykrywania ruchu, gwarantuje, że oprawa włączy się dokładnie wtedy, kiedy potrzebujemy światła.

wyposażona w czujnik ruchu
maksymalny horyzontalny kąt działania czujnika ruchu wynoszący 360°
maksymalny wertykalny kąt działania czujnika ruchu wynoszący 120°
możliwość regulacji czasu świecenia od 5s do 5min
maksymalny zasięg wykrywania ruchu wynoszący 8m
wykrywanie ruchu 0.3...3m/s (1...10km/h)

Materiał obudowy: stal
Materiał klosza: szkło

Kanlux FOGLER DL ceiling light fixture with a replaceable light source is a great choice for staircases, basements, attics and similar spaces. The built-in detector with the maximum angle (360°) of motion detection guarantees that the light turns on exactly when we need it.

provided with a motion sensor
maximum horizontal adjustment range for the motion sensor: 360°
maximum vertical motion sensor angle: 120°
lighting time adjustable in the range of 5 s to 5 min
maximum motion detection range: 8 m
motion detection 0.3...3 m/s (1...10 km/h)

Enclosure material: steel
Lampshade material: glass

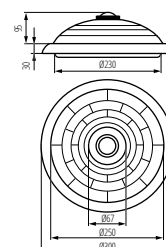

FOGLER DL-2400

Kanlux SANSO LED

PLAFONIERA LED ► CEILING-MOUNTED LED LIGHT FITTING



SANSO LED 15W-NW-SE



SANSO LED 15W-NW-SE | 26520 | 5905339265203 | 15 | 1250 | 4000 | biały | white | PIR

[V]	[Hz]	[°]	[h]	[h]	[lm]	Ra	Hg	SMD	[m]	[m]	[s] - [min]	[lx]	[m]	[W]	[V]	IP
220-240 AC	50	120	≥10000	15000	≤60 Mac/kdam	80					5-5	8-2000	0,5m	83	13	44
[°C]	[mm²]	[m]	[lm]	[lm]	[lm]	[lm]	[lm]	[lm]	[lm]	[lm]	[lm]	[lm]	[lm]	[lm]	[lm]	[lm]
-20+35	0,5-1,5	max 6	H160	5-5	8-2000	0,5m	83	13								
[lm] Quse	[°]	[W]	CE	EAC	UK	CA										
2000	360°	125														



Plafoniera Kanlux SANSO LED z wbudowanym czujnikiem ruchu PIR pozwala na dostosowanie jej do własnych potrzeb. Charakteryzuje się ona także podwyższoną szczelnością (IP 44), dzięki czemu jej wnętrze chronione jest przed kurzem i pyłem.

5 lat gwarancji na warunkach oświadczenia gwarancyjnego, dostępnego na stronie internetowej

Materiał obudowy: PC

Materiał klosza: PC

Kanlux SANSO LED ceiling luminaire with a built-in motion detector PIR allows for its customisation depending on your needs. It is also characterised by increased tightness (IP 44) so its inside is protected against dust and dirt.

5 years Warranty under the terms of the warranty statement, available on our website

Enclosure material: PC

Lampshade material: PC

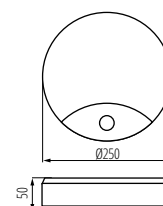

SANSO LED 15W-NW-SE

Kanlux MARC DL

PLAFONIERA Z WYMIENNYM ŹRÓDŁEM ŚWIATŁA ► CEILING-MOUNTED LIGHT FITTING WITH REPLACEABLE LIGHT SOURCE



MARC DL-60



MARC DL-60 | 07015 | 5905339070159 | max 60 | GLS/CFL/LED | E27 | biały | white

[V]	[Hz]	[m]	IP	[m]	[°C]	[m]	[m]
220-240 AC	50	54		-10+35			
[lm]	[m]	CE	EAC	UK	CA		
1-1,5	0,5m						



Plafoniera Kanlux MARC DL to prosty design, wysoka odporność na zapylenie, wilgoć (IP54) i promieniowanie UV to dodatkowe atuty tej oprawy.

wysoka odporność na promieniowanie UV (PIKTO)

Materiał obudowy: PC

Materiał klosza: PC

Kanlux MARC DL ceiling light fixture combines high resistance to dust, moisture (IP54) and UV radiation are other assets of the luminaire.

high UV resistance (PIKTO)

Enclosure material: PC

Lampshade material: PC

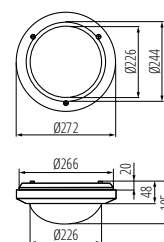

MARC DL-60

Kanlux

ERTON

PLAFONIERA Z WYMIENNYM ŹRÓDŁEM ŚWIATŁA ► CEILING-MOUNTED LIGHT FITTING WITH REPLACEABLE LIGHT SOURCE



ERTON 140 OP-W



ERTON 140 OP-W	35770	5905339357700	max 15	GLS/CFL/LED	E27	biały white
ERTON 240 OP-W	35771	5905339357717	2x max 15	GLS/CFL/LED	E27	biały white

[V] 220-240 AC	[Hz] 50	□	IP 44	🏠	🌡️ -25+35	🔌
📏 0,5m	💡	🔗	CE	ERAC	UK	♻️



Plafonier Kanlux ERTON to estetyczne rozwiązanie dla miejsc o podwyższonej wilgotności. Dwa modele opraw mają możliwość zastosowania silnych źródeł światła - aż do 15W, z czego model 240 OP-W mieści dwa źródła. Te oprawy dzięki stopniowi szczelności IP44 sprawdzają się w profesjonalnych rozwiązaniach domowych jak i komercyjnych.

Materiał obudowy: tworzywo sztuczne

Materiał klosza: PC

The Kanlux ERTON ceiling lamp is an aesthetic solution for places with increased humidity. Two models of luminaires can use strong light sources - up to 15W, of which the 240 OP-W model contains two light sources. These luminaires, thanks to the IP44 rate, are suitable for professional home and commercial solutions.

Enclosure material: plastic

Lampshade material: PC

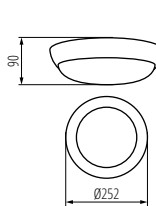

ERTON 140 OP-W

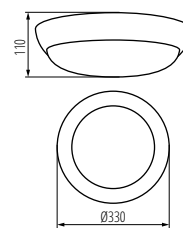

ERTON 240 OP-W

Kanlux

PLAFMIN

PLAFONIERA ► CEILING LIGHT FITTING



PLAFMIN O



PLAFMIN O	25690	5905339256904	max 40	E27	GLS/CFL/LED	biały white
-----------	--------------	---------------	--------	-----	-------------	---------------

[V] 220-240 AC	[Hz] 50	□	IP 20	🏠	🌡️ 5+25	📦
📏 1+2,5	📏 0,5m	CE	ERAC	UK	♻️	



Kanlux PLAFMIN to najbardziej uniwersalna plafoniera w naszej ofercie. Biały kolor, neutralny kształt półkuli, brak jakichkolwiek ozdób i samodzielny wybór źródła światła. Zastosujemy ją w każdym wnętrzu (IP20), szczególnie polecamy ją do hoteli, restauracji i wnętrz domowych w skandynawskim lub minimalistycznym stylu.

Materiał obudowy: tworzywo sztuczne

Materiał klosza: tworzywo sztuczne

Kanlux PLAFMIN is the most universal ceiling light fixture in our offer. White colour, neutral shape of hemisphere, lack of any ornaments and independent selection of light source. It can be used in each interior (IP20), it is particularly recommended to hotels, restaurants and home interiors in the Scandinavian or minimalist style.

Enclosure material: plastic

Lampshade material: plastic

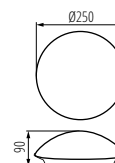

PLAFMIN O

Kanlux HERMI

OPRAWA KANAŁOWA ► BULKHEAD FIXTURE



HERMI 7063NB



HERMI 7063NB | **70524** | 5905339705242 | max 100 | GLS/CFL/LED | E27 | biały | white

[V] 220-240 AC	[Hz] 50	IP 54	IK 06	CE	ERC	UK CA	
	[mm] 1-1,5						

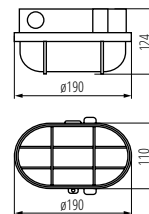

HERMI 7063NB



Kanlux HERMI to oprawa kanałowa z wysokim stopniem szczelności (IP54), który świadczy o jej ochronie przed zapyleniem i bryzgami wody. Oprawa ta posiada dodatkowo metalową siatkę, która chroni klosz oprawy przed uszkodzeniami mechanicznymi.

Materiał obudowy: tworzywo sztuczne

Materiał klosza: szkło

Kanlux HERMI is a channel luminaire with a high tightness rating (IP54), which means high protection against dust and water splashes. The luminaire also has a metal mesh which protects the shade from mechanical damage.

Enclosure material: plastic

Lampshade material: glass

Kanlux MILO

OPRAWA KANAŁOWA ► BULKHEAD FIXTURE



MILO 7040T/P-B



MILO 7040T/P-B	08092	5905339080929	max 60	GLS/CFL/LED	E27	czarny black
MILO 7040T	70522	5905339705228	max 60	GLS/CFL/LED	E27	szary grey
MILO 7040T/P	70523	5905339705235	max 60	GLS/CFL/LED	E27	szary grey

[V] 220-240 AC	[Hz] 50	IP 54	IK 06	CE	ERC	UK CA	
	[mm] 1-1,5						



MILO 7040T



MILO 7040T/P



Kanlux MILO to klasyczna oprawa kanałowa, którą zwykle stosuje się w pomieszczeniach technicznych, garażach, piwnicach, klatkach schodowych, korytarzach itp. Oprawa ta posiada metalową (7040T) lub plastikową (7040T/P) siatkę ochronną, która dodatkowo chroni klosz oprawy przed uszkodzeniami mechanicznymi.

Materiał obudowy: tworzywo sztuczne

Materiał klosza: szkło

Kanlux MILO is a classic channel luminaire used usually in technical rooms, garages, basements, staircases, corridors, etc. The luminaire has a metal (7040T) or plastic (7040T/P) protective mesh which protects the shade from mechanical damage.

Enclosure material: plastic

Lampshade material: glass

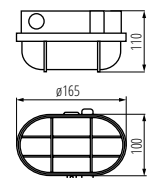

MILO 7040

Kanlux INES

OPRAWA KANAŁOWA ► BULKHEAD FIXTURE



INES 7061N



INES 7061N | 70525 | 5905339705259 max 100 GLS/CFL/LED E27 biały | white

[V] 220-240 AC	[Hz] 50	□	IP 43	🏠	🔧	🔌
1	0,5m	🚫	CE	ERL	UK CA	🔄

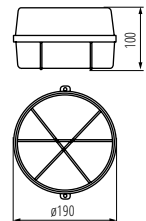

INES 7061N



Kanlux INES to wytrzymała oprawa hermetyczna (IK08), z wymiennym źródłem światła, która posiada dodatkową ochronę w postaci metalowej siatki.

Materiał obudowy: tworzywo sztuczne

Materiał klosza: szkło

Kanlux INES is a durable hermetic luminaire (IK08) with a replaceable light source and additional protection - a metal mesh.

Enclosure material: plastic

Lampshade material: glass

Kanlux SANGA DL

PLAFONIERA Z WYMIENNYM ŹRÓDŁEM ŚWIATŁA ► CEILING-MOUNTED LIGHT FITTING WITH REPLACEABLE LIGHT SOURCE



SANGA DL-100



SANGA DL-100 | 08050 | 5905339080509 max 100 GLS/CFL/LED E27 biały | white

[V] 220-240 AC	[Hz] 50	□	IP 44	🏠	🔧	🔌
1-1,5	0,5m	🚫	CE	ERL	UK CA	🔄

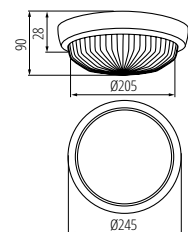

SANGA DL-100



Plafoniera Kanlux SANGA to ekonomiczne rozwiązanie dla klatek schodowych, piwnic, strychów, garaży, lecz także dla tarasów i balkonów.

Materiał obudowy: tworzywo sztuczne

Materiał klosza: szkło

Kanlux SANGA ceiling fixture is an economical solution for staircases, basements, attics, garages, and also for terraces and balconies.

Enclosure material: plastic

Lampshade material: glass

Kanlux TUNA

PLAFONIERA Z WYMIENNYM ŹRÓDŁEM ŚWIATŁA ► CEILING-MOUNTED LIGHT FITTING WITH REPLACEABLE LIGHT SOURCE



TUNA S1101-W



TUNA MINI N



Plafoniera Kanlux TUNA to rozwiązanie dla klatek schodowych, piwnic, strychów i innych tego typu pomieszczeń. Odpowiedni stopień ochrony przed zapyleniem i wilgocią umożliwia stosowanie oprawy zarówno wewnątrz jak i na zewnątrz budynków.

Materiał obudowy: tworzywo sztuczne
Materiał klosza: szkło

Kanlux TUNA ceiling light fixture is a good choice for staircases, basements, attics and other such rooms. Proper level of protection against dust and moisture allows for its use both indoors and outdoors.

Enclosure material: plastic
Lampshade material: glass



TUNA S1101-W	04260	5905339042606	max 100	GLS/CFL/LED	E27	biały white
TUNA MINI N	08091	5905339080912	max 100	GLS/CFL/LED	E27	biały white

[V] 220-240 AC	[Hz] 50	□	IP 44	🏠	🔧	🔌
📏 1-1,5	📏 0,5m	🚫	CE	ERC	UK CA	🔄

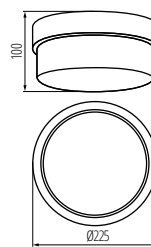

TUNA S1101

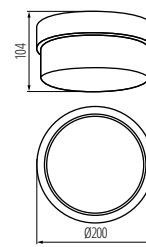

TUNA MINI

Kanlux TURK

PLAFONIERA Z WYMIENNYM ŹRÓDŁEM ŚWIATŁA ► CEILING-MOUNTED LIGHT FITTING WITH REPLACEABLE LIGHT SOURCE



TURK DL-60



Kanlux TURK to wysoka odporność na promieniowanie UV sprawiająca, że doskonale sprawdzi się w warunkach użytkowania zewnętrznego, np. na elewacji budynku, tarasie czy balkonie.

wysoka odporność na promieniowanie UV (PIKTO)
Materiał obudowy: PC
Materiał klosza: PC

Kanlux TURK is a fixture with high resistance to UV radiation makes it perfect for outdoor use, e.g. on building façade, terrace or balcony.

high UV resistance (PICTO)
Enclosure material: PC
Lampshade material: PC



TURK DL-60	07025	5905339070258	max 60	E27	biały white
------------	-------	---------------	--------	-----	---------------

[V] 220-240 AC	[Hz] 50	□	IP 54	🏠	🔧	🔌
📏 1-2,5	📏 0,5m	🚫	CE	ERC	UK CA	🔄

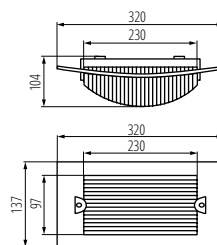

TURK DL-60

HIMA LED

OPRAWA TYPU DOWNLIGHT ► DOWNLIGHT FITTING



HIMA LED 23W-NW-W



HIMA LED 23W-NW-W



HIMA LED 23W-NW-B



HIMA LED 33W-NW-W



Downlighty Kanlux HIMA LED to oprawy o wysokiej wydajności świetlnej (ponad 110 lm/W). Możliwość regulacji opraw w dwóch osiach oraz wysoki współczynnik oddawania barw sprawiają, że oprawy idealnie sprawdzą się w miejscach, gdzie ważne jest wyeksponowanie konkretnych stref i kolorów - butiki, stoiska handlowe czy sklepy wielkopowierzchniowe. Kanlux HIMA LED to oprawy o dużej mocy, więc nawet w wysokich pomieszczeniach dostarczą odpowiednią ilość światła. Niezawodność tych lamp potwierdza 5 lat gwarancji.

5 lat gwarancji na warunkach oświadczenia gwarancyjnego, dostępnego na stronie internetowej

Materiał obudowy: stop aluminium

Materiał klosza: szkło

Kanlux HIMA LED downlights are luminaires with high luminous efficiency (over 110 lm/W). The possibility of adjusting the luminaires in two axes and high colour rendering index make the luminaires ideal for places where it is important to expose specific zones and colours - boutiques, sales stands or large-format stores. Kanlux HIMA LED is a high power luminaire, so it will provide the right amount of light even in high rooms. The reliability of these lamps is confirmed by a 5-year warranty.

5 years Warranty under the terms of the warranty statement, available on our website

Enclosure material: aluminum alloy

Lampshade material: glass



HIMA LED 23W-NW-W	22841	5905339228413	23	biały white	2510	45	4000
HIMA LED 23W-NW-B	22842	5905339228420	23	czarny black	2510	45	4000
HIMA LED 33W-NW-W	22843	5905339228437	33	biały white	3670	45	4000
HIMA LED 33W-NW-B	22844	5905339228444	33	czarny black	3670	45	4000

[V]	[Hz]	[lm]	[h]	[Ra]	[°]	[K]
220-240 AC	50	≥15000	30000	≥90	45	4000
IP 20	5+25	≤6x Macadam	45	COB	350	0,5-0,75
175 (mm)	0,5m	CE	ERC	CUK		

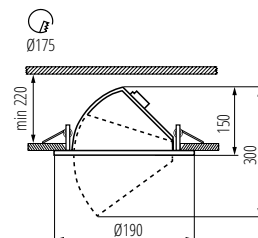

HIMA LED



TIBERI PRO

OPRAWA TYPU DOWNLIGHT ► DOWNLIGHT FITTING



TIBERI PRO 20W-940-W



TIBERI PRO 20W-940-B



TIBERI PRO 30W-940-W



TIBERI PRO 30W-940-B



TIBERI PRO 40W-940-W



TIBERI PRO 40W-940-B

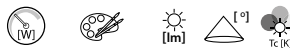

Model	Code	Part No.	Power (W)	Color	Beam Angle (°)	Beam Diameter (mm)	Luminous Flux (lm)	Color Temp. (K)
TIBERI PRO 20W-940-W	35670	5905339356703	20	biały white	2100	90	4000	
TIBERI PRO 20W-940-B	35671	5905339356710	20	czarny black	1900	90	4000	
TIBERI PRO 30W-940-W	35672	5905339356727	30	biały white	3150	90	4000	
TIBERI PRO 30W-940-B	35673	5905339356734	30	czarny black	2850	90	4000	
TIBERI PRO 40W-940-W	35674	5905339356741	40	biały white	4200	90	4000	
TIBERI PRO 40W-940-B	35675	5905339356758	40	czarny black	3800	90	4000	

[V] 220-240 AC	[Hz] 50	[h] ≥30000	[h] 50000	[lm] ≥6k MacAdam	Ra 90	SMD	IP 44/20
[°C] 5+25	[m] 0,5m	CE	ERC	UK	CA	RoHS	

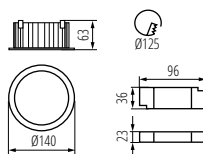

TIBERI PRO 20W

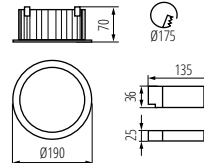

TIBERI PRO 30W

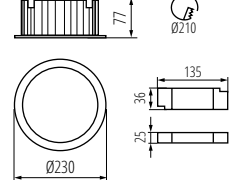

TIBERI PRO 40W

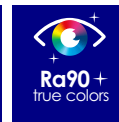

Oprawy Kanlux TIBERI PRO to oprawy podtynkowe, czyli idealnie współgrające z sufitami podwieszanymi. Doskonale rozświetlą ciągi komunikacyjne, przestrzenie sanitarne czy powierzchnie biurowe oraz handlowe. Atuty tych downlightów to: 50.000 godzin trwałości, wysokie odwzorowanie naturalnych barw (CRI>90), skuteczność świetlna do 105lm/W i 5 lat gwarancji. Podwyższona szczelność (IP44/20) opraw Kanlux TIBERI PRO chroni je przed kurzem, pyłem i wilgocią.

5 lat Gwarancji na warunkach oświadczenia gwarancyjnego, dostępnego na stronie internetowej

Materiał obudowy: stop aluminium

Materiał klosza: tworzywo sztuczne

Kanlux TIBERI PRO are flush-mounted luminaires, which means they are perfectly compatible with suspended ceilings. They perfectly illuminate passageways, sanitary facilities or office and retail areas. The advantages of these downlights include: 50,000 hours of service life, excellent reproduction of natural colours (CRI>90), luminous efficacy of up to 105lm/W and a 5-year warranty. The increased protection rating (IP44/20) of Kanlux TIBERI PRO luminaires protects them from dust, particles and moisture.

5 years Warranty under the terms of the warranty statement, available on our website

Enclosure material: aluminum alloy

Lampshade material: plastic

Kanlux

TIBERI PRO NT

OPRAWA TYPU DOWNLIGHT ► DOWNLIGHT FITTING



TIBERI PRO NT20W-940B



TIBERI PRO NT30W-940B



TIBERI PRO NT20W-940W



TIBERI PRO NT30W-940W



Kanlux TIBERI PRO NT to rodzina natynkowych opraw typu downlight. Dostępne są w dwóch mocach (20W i 30 W) i dwóch kolorach (biały czarny) przy zachowaniu tego samego rozmiaru. Oprawa Kanlux TIBERI PRO to przede wszystkim wysoka szczelność (IP54) i wysoki współczynnik oddawania barw (Ra>90), ale także łatwy montaż na suficie za pomocą uchwyty. Oprawa Kanlux TIBERI PRO NT to wysoka jakość komponentów potwierdzona 5 letnią gwarancją.

5 lat Gwarancji na warunkach oświadczenia gwarancyjnego, dostępnego na stronie internetowej

Materiał obudowy: stop aluminium

Materiał klosza: tworzywo sztuczne

Kanlux TIBERI PRO NT is a family of surface-mounted downlights. They are available in two wattages (20W and 30W) and two colors (white and black) while keeping the same size. The Kanlux TIBERI PRO luminaire is primarily characterized by high tightness (IP54) and high color rendering index (Ra> 90), but also easy installation on the ceiling using a bracket. The Kanlux TIBERI PRO NT luminaire is a high quality component confirmed by a 5-year warranty.

5 years Warranty under the terms of the warranty statement, available on our website

Enclosure material: aluminum alloy

Lampshade material: plastic

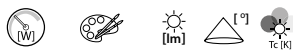

TIBERI PRO NT20W-940W	35676	5905339356765	20	biały white	2200	115	4000
TIBERI PRO NT20W-940B	35677	5905339356772	20	czarny black	2200	115	4000
TIBERI PRO NT30W-940W	35678	5905339356789	30	biały white	3000	115	4000
TIBERI PRO NT30W-940B	35679	5905339356796	30	czarny black	3000	115	4000

[V]	[Hz]	[h]	[h]	ellipse ≤ 6x MacAdam	Ra	SMD	CE	RoHS	IP
220-240 AC	50	≥30000	50000	90	90				54
[m]	[mm]	[m]	[m]						
0,18	0,75	0,5m							

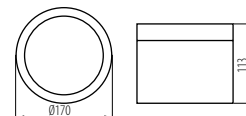

TIBERI PRO NT

AREL LED

OPRAWA TYPU DOWNLIGHT ► DOWNLIGHT FITTING



AREL LED D 14W

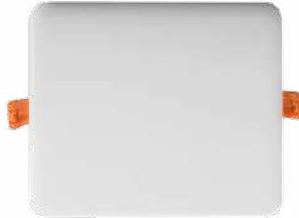

AREL LED DL 14W



AREL LED DO 6W



AREL LED DL 6W



AREL LED DO 10W

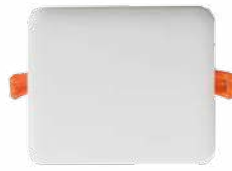

AREL LED DL 10W

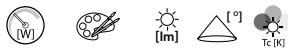

Model	Code	Part No.	Size	Color	Beam Angle (lm)	Beam Angle (°)	Temp. Class
AREL LED DO 6W-NW	29580	5905339295804	6	biały white	450	120	4000
AREL LED DO 6W-WW	29581	5905339295811	6	biały white	440	120	3000
AREL LED DL 6W-NW	29582	5905339295828	6	biały white	490	120	4000
AREL LED DO 10W-NW	29584	5905339295842	10	biały white	940	120	4000
AREL LED DO 10W-WW	29585	5905339295859	10	biały white	890	120	3000
AREL LED DL 10W-NW	29586	5905339295866	10	biały white	1000	120	4000
AREL LED DO 14W-NW	29588	5905339295880	14	biały white	1300	120	4000
AREL LED DO 14W-WW	29589	5905339295897	14	biały white	1210	120	3000
AREL LED DL 14W-NW	29590	5905339295903	14	biały white	1300	120	4000

[V] 220-240 AC	[Hz] 50	[h] ≥30000	[h] 15000	[lm] ≤6xLockdim	[Ra] 80	[SMD]	[DALI]	[IP] IP 65/20	[House]
[°C] 5+25	[mm] 0,75-1,5	[mm] 0,5m	[°] 360°	[CE]	[EAC]	[UK CA]	[DALI]		



IP 65/20

ultra SLIM panel

HIGH quality

Kanlux AREL LED to nowa rodzina downlightów, które nie posiadają ramki. Wysoka klasa szczelności IP65/20 oraz wyjątkowy, prosty, a zarazem zaskakujący design sprawia, że Kanlux AREL LED wpasuje się w każde wnętrze. Dzięki unikatowej konstrukcji, panel ma grubość zaledwie 9 mm – to najcieńszy panel dostępny na rynku.

Materiał obudowy: stop aluminium
Materiał klosza: PMMA

Kanlux AREL LED is a new family of downlights which do not have frame. High tightness class IP65/20 and exceptional, simple, and at the same time surprising design make Kanlux AREL LED fit into each interior. Thanks to the unique structure, the panel is only 9 mm thick - it is the thinnest panel available on the market.

Enclosure material: aluminum alloy
Lampshade material: PMMA

AREL FRAME DO 14W W | **33651** | 5905339336514 | biały | white

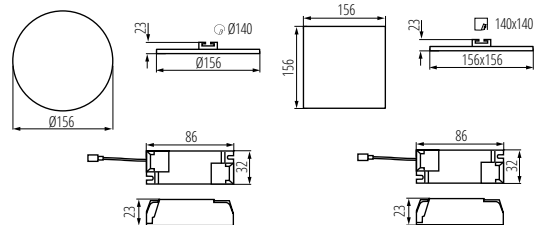

AREL LED DO 14W

AREL LED DL 14W

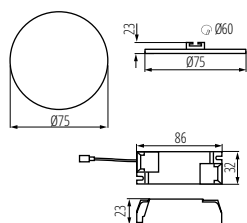

AREL LED DO 6W

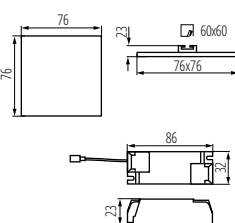

AREL LED DL 6W

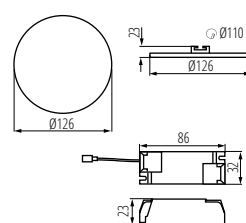

AREL LED DO 10W

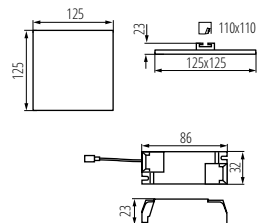

AREL LED DL 10W

Kanlux

MATEO ES

OPRAWA TYPU DOWNLIGHT ► DOWNLIGHT FITTING



MATEO ES DLP-150-B



MATEO ES DLP-150-B	32930	5905339329301	max 25	czarny black
MATEO ES DLP-150-W	32931	5905339329318	max 25	biały white
MATEO ES DLP-250-B	32932	5905339329325	2 x max 25	czarny black
MATEO ES DLP-250-W	32933	5905339329332	2 x max 25	biały white

[V] 220-240 AC	[Hz] 50	ES-111	GU10		IP 20		5+25		
65/35	1,5	0,5m		CE	ERC	UK CA			



MATEO ES DLP-150-W



MATEO ES DLP-250-B



MATEO ES DLP-250-W



Kanlux MATEO ES to elegancka oprawa sufitowa, do której pasują efektowne żarówki Kanlux ES-111. Korpus oprawy jest wykonany ze stali w czarnym, matowym kolorze, a wykończenie opraw jest białe. Przez takie zestawienie kolorystyczne lampy te zyskują stylowy charakter. Dzięki regulacji kątowej możemy skierować światło na wybrany przez nas punkt.

Materiał obudowy: stop aluminium

Kanlux MATEO ES is an elegant ceiling luminaire which can be matched with the spectacular Kanlux ES-111 bulbs. The luminaire body is made of steel and finished in matt black. You can choose between black or white lamp finish. Thanks to angle adjustment, you can direct the light to a selected point.

Enclosure material: aluminum alloy

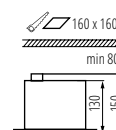

MATEO ES DLP-150

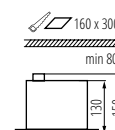

MATEO ES DLP-250

Kanlux

IVIAN LED

OPRAWA PUNKTOWA LED IP44 ► LED SPOTLIGHT FITTING, IP44



IVIAN LED 4,5W W



IVIAN LED 4,5W SN

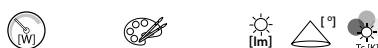

MAN LED 4,5W W-WW	25780	5905339257802	4,5	biały white	430	100	3000
MAN LED 4,5W SN-WW	25781	5905339257819	4,5	nikiel satynowy nickel satin	410	100	3000
MAN LED 4,5W W-NW	25782	5905339257826	4,5	biały white	480	100	4000
MAN LED 4,5W SN-NW	25783	5905339257833	4,5	nikiel satynowy nickel satin	460	100	4000

[V] 220-240 AC	[Hz] 50	≥25000	15000	ellipse ≤ 6x Markham	Ra 80	SMD			IP 44
	5+25		Ø65	0,5m	CE	ERC	UK CA		



Kanlux IVIAN LED to rodzina opraw typu downlight. Charakteryzuje się podwyższonym stopniem szczelności – IP44, co pozwala na zastosowanie jej w łazienkach i pomieszczeniach o zwiększonej wilgotności. Źródło światła stanowią diody LED SMD, a obudowa wykonana jest z tworzywa sztucznego.

Materiał obudowy: tworzywo sztuczne

Materiał klosza: tworzywo sztuczne

Kanlux IVIAN LED is a family of downlight type holders. It is characterized by an increased degree of tightness - IP44, which allows using it in bathrooms and rooms with increased humidity. LED SMD diodes are the light source and the casing is made of plastic.

Enclosure material: plastic

Lampshade material: plastic

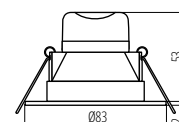

IVIAN LED 4-5W

TAVO LED

OPRAWA TYPU DOWNLIGHT ► DOWNLIGHT FITTING



TAVO LED DO 5W-NW



Kanlux TAVO LED to rodzina podtynkowych downlightów. Dostępne są w dwóch kształtach (okrągły i kwadratowy) i aż 5 mocach - od 5W do 24W. Downlighty Kanlux TAVO LED cechuje minimalistyczny, skandynawski design. Dodatkowymi atutami jest ich szczelność IP44/20, a także możliwość montażu natynkowego modeli 12W i 18W w ramce Kanlux TAVO FRAME.

Materiał obudowy: tworzywo sztuczne

Materiał klosza: tworzywo sztuczne

Kanlux TAVO LED is a family of flush-mounted downlights. They are available in two shapes (round and square) and 5 wattages - from 5W to 24W. Kanlux TAVO LED downlights are characterised by a minimalist, Scandinavian design. Additional advantages are their IP44/20 tightness, as well as the possibility of surface mounting the 12W and 18W models in the Kanlux TAVO FRAME.

Enclosure material: plastic

Lampshade material: plastic

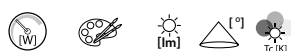

TAVO LED DO 5W-NW	36510	5905339365101	5	biały white	400	120	4000
TAVO LED DO 9W-NW	36511	5905339365118	9	biały white	900	120	4000
TAVO LED DO 12W-NW	36512	5905339365125	12	biały white	1250	120	4000
TAVO LED DO 18W-NW	36513	5905339365132	18	biały white	1900	120	4000
TAVO LED DO 24W-NW	36514	5905339365149	24	biały white	2600	120	4000
TAVO LED DL 5W-NW	36515	5905339365156	5	biały white	400	120	4000
TAVO LED DL 9W-NW	36516	5905339365163	9	biały white	900	120	4000
TAVO LED DL 12W-NW	36517	5905339365170	12	biały white	1250	120	4000
TAVO LED DL 18W-NW	36518	5905339365187	18	biały white	1900	120	4000
TAVO LED DL 24W-NW	36519	5905339365194	24	biały white	2600	120	4000

[V]	[Hz]	[lm]	[h]	[CRI]	[Ra]	[SMD]	[IP]
220-240 AC	50	≥15000	25000	≤6x Macadam	80	SMD	44/20
[°C]	[°C]	[m]	[m]	[m]	[m]	[CE]	[UK CA]
5+25	5+25	0,1	0,5m	0,5m	0,5m	CE	UK CA

AKCESORIA ► ACCESSORIES

TAVO FRAME DO 12W	36520	5905339365200	Ramka do montażu natynkowego downlightów Kanlux TAVO LED.
TAVO FRAME DO 18W	36521	5905339365217	Ramka do montażu natynkowego downlightów Kanlux TAVO LED.
TAVO FRAME DL 12W	36522	5905339365224	Ramka do montażu natynkowego downlightów Kanlux TAVO LED.
TAVO FRAME DL 18W	36523	5905339365231	Ramka do montażu natynkowego downlightów Kanlux TAVO LED.



TAVO FRAME DO 12W



TAVO FRAME DO 18W



TAVO FRAME DL 12W



TAVO FRAME DL 18W

Kanlux

TAVO LED

OPRAWA TYPU DOWNLIGHT ► DOWNLIGHT FITTING



TAVO LED DO 5W-NW



TAVO LED DO 9W-NW



TAVO LED DO 12W-NW



TAVO LED DO 18W-NW



TAVO LED DO 24W-NW



TAVO LED DL 5W-NW



TAVO LED DL 9W-NW



TAVO LED DL 12W-NW



TAVO LED DL 18W-NW



TAVO LED DL 24W-NW

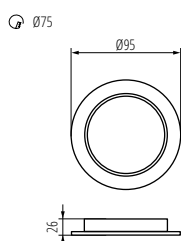

TAVO LED DO 5W-NW

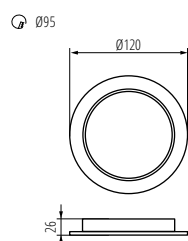

TAVO LED DO 9W-NW

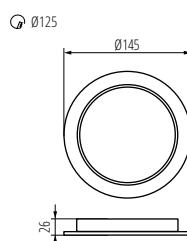

TAVO LED DO 12W-NW

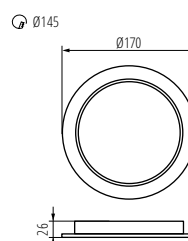

TAVO LED DO 18W-NW

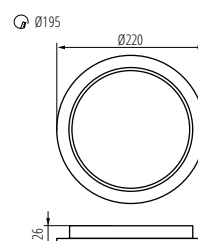

TAVO LED DO 24W-NW

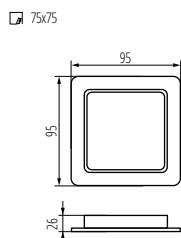

TAVO LED DL 5W-NW

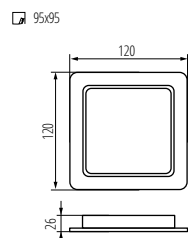

TAVO LED DL 9W-NW

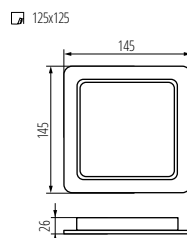

TAVO LED DL 12W-NW

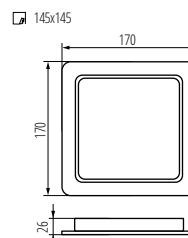

TAVO LED DL 18W-NW

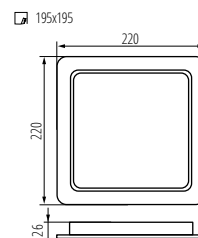

TAVO LED DL 24W-NW



ROUNDA V2LED

OPRAWA TYPU DOWNLIGHT ► DOWNLIGHT FITTING



ROUNDA V2LED18W-W



Model	Code	Power (W)	Beam Angle (°)	Color	Light Output (lm)	Beam Angle (°)	Height (mm)
ROUNDA V2LED24W-NW-SN	27220	5905339272201	24	nikiel satynowy nickel satin	1700	110	4000
ROUNDA V2LED6W-NW-SN	27221	5905339272218	6	nikiel satynowy nickel satin	300	110	4000
ROUNDA V2LED12W-NW-SR	28930	5905339289308	12	srebrny silver	660	110	4000
ROUNDA V2LED12W-NW-W	28931	5905339289315	12	biały white	780	110	4000
ROUNDA V2LED12W-WW-W	28932	5905339289322	12	biały white	720	110	3000
ROUNDA V2LED18W-NW-SR	28933	5905339289339	18	srebrny silver	1080	110	4000
ROUNDA V2LED18W-NW-W	28934	5905339289346	18	biały white	1260	110	4000
ROUNDA V2LED18W-WW-W	28935	5905339289353	18	biały white	1200	110	3000
ROUNDA V2LED24W-NW-W	28936	5905339289360	24	biały white	1680	110	4000
ROUNDA V2LED6W-NW-W	28937	5905339289377	6	biały white	330	110	4000
ROUNDA V2LED6W-WW-W	28938	5905339289384	6	biały white	300	110	3000
ROUNDA V2LED24W-WW-W	33524	5905339335241	24	biały white	1560	110	3000
ROUNDA V2LED6W-WW-B	33562	5905339335623	6	czarny black	270	110	3000

[V] 220-240 AC	[Hz] 50	≥20000	[h] 15000	≤6 for Macadam	Ra 80	SMD	IP 44/20	House icon
5+25	House icon	House icon	[m] 0,05	[mm] 0,75	0,5m	360°	CE	UK



Kanlux ROUNDA V2LED to nowa wersja popularnych okrągłych opraw typu downlight do użytku wewnętrznego. Downlighty te łączą w sobie estetyczne wzornictwo ze światłem uzyskiwanym dzięki technologii LED. Wysoka klasa szczelności IP44 zapobiega wnikaniu wody i kurzu do wnętrza.

Materiał obudowy: stop aluminium
Materiał klosza: tworzywo sztuczne

Kanlux ROUNDA V2LED is a new version of popular round downlight luminaires for indoor use. The downlights combine aesthetic design with light obtained thanks to LED technology. No water or dust can get to the inside owing to the high class of tightness (IP44).

Enclosure material: aluminum alloy
Lampshade material: plastic

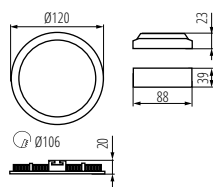

ROUNDA V2LED6W

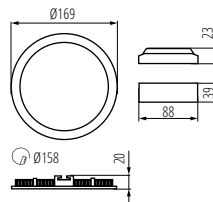

ROUNDA V2LED12W

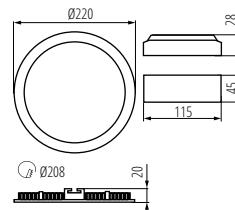

ROUNDA V2LED18W

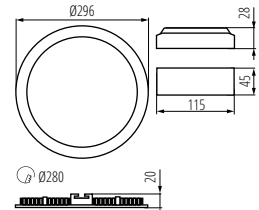

ROUNDA V2LED24W

Kanlux

ROUNDA V2LED

OPRAWA TYPU DOWNLIGHT ► DOWNLIGHT FITTING



ROUND V2LED6W-W



ROUND V2LED6W-SN



ROUND V2LED6W-SR



ROUND V2LED6W-B



ROUND V2LED12W-W



ROUND V2LED12W-SR



ROUND V2LED18W-W



ROUND V2LED18W-NW-SR



ROUND V2LED24W-W



ROUND V2LED24W-SN



KATRO V2LED

OPRAWA TYPU DOWNLIGHT ► DOWNLIGHT FITTING



KATRO V2LED 18W-W

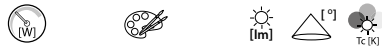

Model	Code	Power (W)	Color	Length (mm)	Width (mm)	Height (mm)
KATRO V2LED 24W-NW-SN	27216	5905339272164	24 nikiel satynowy nickel satin	1700	110	4000
KATRO V2LED 12W-NW-SR	28939	5905339289391	12 srebrny silver	660	110	4000
KATRO V2LED 12W-NW-W	28940	5905339289407	12 biały white	780	110	4000
KATRO V2LED 12W-WW-W	28941	5905339289414	12 biały white	720	110	3000
KATRO V2LED 18W-NW-SR	28942	5905339289421	18 srebrny silver	1080	110	4000
KATRO V2LED 18W-NW-W	28943	5905339289438	18 biały white	1260	110	4000
KATRO V2LED 24W-NW-W	28945	5905339289452	24 biały white	1680	110	4000
KATRO V2LED 6W-NW-W	28946	5905339289469	6 biały white	330	110	4000

[V] 220-240 AC	[Hz] 50	≥20000	15000	≤60 MacAdam	Ra 80	SMD	IP 44/20	5±25
0,05	0,75	0,5m	360° Φuse	CE	ERL	UK CA		



Kanlux KATRO V2LED to nowa wersja opraw KATRO N LED, popularnych kwadratowych downlightów do użytku wewnętrznego. Łączą w sobie estetyczne wzornictwo ze światłem uzyskiwanym dzięki technologii LED. Wysoka klasa szczelności IP44 zapobiega wnikiemu wody i kurzu do wnętrza.

Materiał obudowy: stop aluminium
Materiał klosza: tworzywo sztuczne
Kanlux KATRO V2LED is a new version of KATRO N LED luminaires, popular square downlights for indoor use. They combine aesthetic design with light obtained owing to LED technology. No water or dust can get to the inside owing to the high class of tightness (IP44).

Enclosure material: aluminum alloy
Lampshade material: plastic

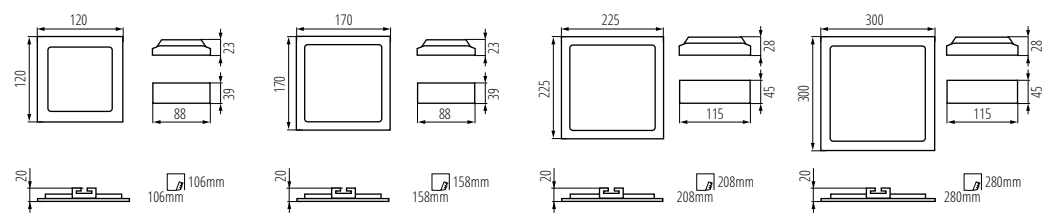

KATRO V2LED 6W

KATRO V2LED 12W

KATRO V2LED 18W

KATRO V2LED 24W

Kanlux

KATRO V2LED

OPRAWA TYPU DOWNLIGHT ► DOWNLIGHT FITTING



KATRO V2LED 6W-W



KATRO V2LED 12W-W



KATRO V2LED 12W-SR



KATRO V2LED 18W-W



KATRO V2LED 18W-SR

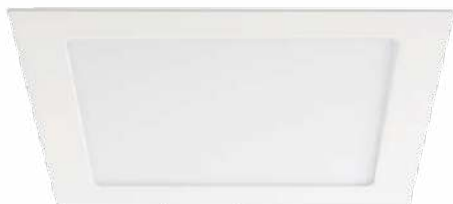

KATRO V2LED 24W-W



KATRO V2LED 24W-SN



CARSA V2LED

OPRAWA TYPU DOWNLIGHT ► DOWNLIGHT FITTING



CARSA V2LED 24W-NW-W



CARSA V2LED 12W-NW-W



CARSA V2LED 18W-NW-W

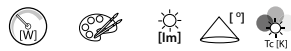

CARSA V2LED 12W-NW-W	28948	5905339289483	12	biały white	780	110	4000
CARSA V2LED 18W-NW-W	28949	5905339289490	18	biały white	1260	110	4000
CARSA V2LED 24W-NW-W	33541	5905339335418	24	biały white	1680	110	4000

[V] 220-240 AC	[Hz] 50	[h] ≥20000	[h] 15000	diffuse ≤ for MacAdam	Ra 80	SMD	IP 20	house icon
5+25	[m] 0,05	[m] 0,75	[m] 0,5m	CE	ERC	UK CA	down arrow icon	

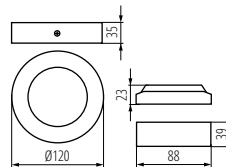

CARSA V2LED 12W

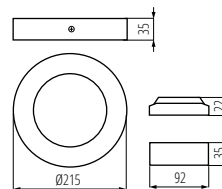

CARSA V2LED 18W

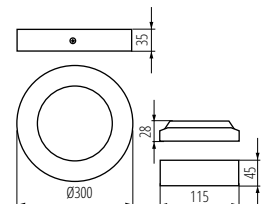

CARSA V2LED 24W



Kanlux CARSA V2 LED to okrągła oprawa natynkowa charakteryzująca się harmonijnym połączeniem technologii LED z atrakcyjnym i nowoczesnym wyglądem. Wyróżnia się wysoką energooszczędnością, przy jednoczesnym zachowaniu doskonałych parametrów świetlnych. Kanlux CARSA V2 LED doskonale sprawdza się w oświetleniu wnętrz mieszkalnych jak i pomieszczeń biurowych.

Materiał obudowy: stop aluminium

Materiał klosza: tworzywo sztuczne

Kanlux CARSA V2 LED is a round façade luminaire characterised by harmonious combination of LED technology with attractive and modern looks. It is distinguished by high energy efficiency with maintained excellent light parameters. Kanlux CARSA V2 LED is perfect for lighting residential interiors and office rooms.

Enclosure material: aluminum alloy

Lampshade material: plastic

Kanlux

KANTI V2LED

OPRAWA TYPU DOWNLIGHT ► DOWNLIGHT FITTING



KANTI V2LED 18W-SN



KANTI V2LED 12W-W



KANTI V2LED 12W-SN



KANTI V2LED 18W-W



Kanlux KANTI V2 LED to kwadratowa oprawa natynkowa charakteryzująca się harmonijnym połączeniem nowoczesnej technologii z atrakcyjnym i nowoczesnym wyglądem. Wyróżnia się wysoką energooszczędnością, przy jednoczesnym zachowaniu doskonałych parametrów świetlnych. Kanlux KANTI V2 LED doskonale sprawdza się w oświetleniu wnętrz mieszkalnych i pomieszczeń biurowych.

Materiał obudowy: stop aluminium

Materiał klosza: tworzywo sztuczne

Kanlux KANTI V2 LED is a square façade luminaire characterised by harmonious combination of modern technology with attractive and modern looks. It is distinguished by high energy efficiency with maintained excellent light parameters. Kanlux KANTI V2 LED is perfect for lighting residential interiors and office rooms.

Enclosure material: aluminum alloy

Lampshade material: plastic



KANTI V2LED 12W-NW-SN	27212	5905339272126	12	nikiel satynowy nickel satin	720	110	4000
KANTI V2LED 18W-NW-SN	27213	5905339272133	18	nikiel satynowy nickel satin	1200	110	4000
KANTI V2LED 12W-NW-W	28950	5905339289506	12	biały white	780	110	4000
KANTI V2LED 18W-NW-W	28951	5905339289513	18	biały white	1260	110	4000

[V]	[Hz]	[h]	[h]	ellipse ≤ 6x MacAdam	Ra	SMD	IP	°C
220-240 AC	50	≥20000	15000	80	80	IP 20	5+25	
[mm]	[mm]	[mm]	[mm]	360° Φuse	CE	EAC	UK	CA
0,05	0,75	0,5m						

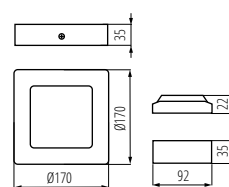

KANTI V2LED 12W

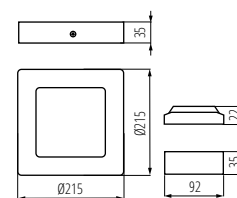

KANTI V2LED 18W

Kanlux

FL AGOR HI

NAŚWIETLACZ LED ► LED FLOODLIGHT



FL AGOR HI 240W NW



FL AGOR/A HI 240W NW



FL AGOR HI 300W NW



FL AGOR/A HI 300W NW

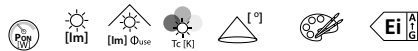

FL AGOR HI 240W NW	33476	5905339334763	240	36000	28800	4000	90	czarny black	D
FL AGOR/A HI 240W NW	33477	5905339334770	240	36000	28800	4000	X40/Y90	czarny black	D
FL AGOR HI 300W NW	33478	5905339334787	300	45000	36000	4000	90	czarny black	D
FL AGOR/A HI 300W NW	33479	5905339334794	300	45000	36000	4000	X40/Y90	czarny black	D

[V] 220-240 AC	[Hz] 50	120° Φ _{use}	≥50000	50000 (h)	≤6x/MaxCam	Ra 70	SMD		IP 65		-20+45 °C
	180°	IK 08		0,28 (mm)	1 (mm)	1m		CE	ERC	UK	

AKCESORIA ► ACCESSORIES

FLAGOR HI GRID 240W	33482	5905339334824	Siatka ochronna do naświetlacza FL AGOR HI 240W, FL AGOR HI GRID 240W, czarna (33482) Protective grid for floodlight FL AGOR HI 240W, FL AGOR HI GRID 240W, black (33482)								
FLAGOR HI GRID 300W	33483	5905339334831	Siatka ochronna do naświetlacza FL AGOR HI 300W, FL AGOR HI GRID 300W, czarna (33483) Protective grid for floodlight FL AGOR HI 300W, FL AGOR HI GRID 300W, black (33483)								

WARRANTY
5 years

SUPER HIGH
lumen

up to

150 lm/W

Naświetlacze Kanlux AGOR HI to dwie wysokie moce: 240W i 300W. To naświetlacze dostępne w dwóch wersjach: FL AGOR HI (symetryczna), FL AGOR/A HI (asymetryczna) z 5 letnią gwarancją. Kanlux AGOR LED HI to produkt profesjonalny, zadbałszy w nim o ochronę przed przepięciem (6kV), wysoką szczelność (IP 65) i odporność na uszkodzenia mechaniczne (IK08). Dodatkowym atutem jest bardzo wysoka skuteczność: do 150lm/W. Oprawy przeznaczone są do oświetlania większych powierzchni przemysłowych, komercyjnych i sportowo rekreacyjnych. Dodatkowym akcesorium zabezpieczającym jest siatka ochronna.

5 lat Gwarancji na warunkach oświadczenia gwarancyjnego, dostępnego na stronie internetowej

Materiał obudowy: stop aluminium

Materiał szyby ochronnej: szkło hartowane

Kanlux AGOR HI floodlights have two high power options: 240W and 300W. These floodlights are available in two versions: FL AGOR HI (symmetrical), FL AGOR / A HI (asymmetrical) with a 5-year warranty. Kanlux AGOR LED HI is a professional product, we took care of protection against overvoltage (6kV), high tightness (IP 65) and resistance to mechanical damage (IK08). An additional advantage is very high efficiency: up to 150lm / W. Luminaires are designed to illuminate larger industrial, commercial and recreational areas. An additional safety accessory is a protective grid.

5 years Warranty under the terms of the warranty statement, available on our website

Enclosure material: aluminum alloy

Protective glass material: Tempered glass

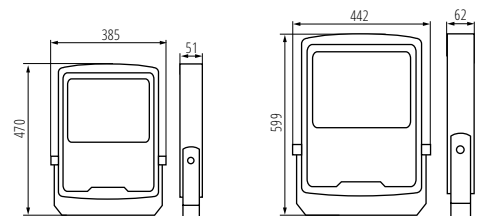

FL AGOR/A HI 240W

FL AGOR/A HI 300W

IQ-LED FL

NAŚWIETLACZ LED ► LED FLOODLIGHT



IQ-LED FL-30W-NW



up to

120 $\frac{\text{lm}}{\text{W}}$

DE
ST
GN
unique

LED
techno
logy

Naświetlacze Kanlux IQ FL to produkt wyjątkowy. Ich automatyczna produkcja pozwala zapewnić najwyższą jakość produktu i powtarzalność parametrów świetlnych. Ich atutem są także markowe diody LED o trwałości 50000 godzin. Wykorzystanie najwyższej jakości komponentów przekłada się na pięcioletnią gwarancję całej serii naświetlaczy Kanlux IQ FL.

5 lat Gwarancji na warunkach oświadczenia gwarancyjnego, dostępnego na stronie internetowej

Materiał obudowy: metal

Materiał klosza: szkło hartowane

Kanlux IQ FL floodlights are unique products. Their automatic production allows ensuring the highest quality and repeatability of lighting parameters. They include brand LEDs with a life span of 50,000 hours, which is also their additional advantage. The use of the highest quality components allows us to provide our customers with a five-year warranty for the whole series of Kanlux IQ FL floodlights.

5 years Warranty under the terms of the warranty statement, available on our website

Enclosure material: Metal

Lampshade material: Tempered glass



IQ-LED FL-10W-NW	33880	5905339338808	10	1200	4000	65	czarny black
IQ-LED FL-20W-NW	33881	5905339338815	20	2300	4000	65	czarny black
IQ-LED FL-30W-NW	33882	5905339338822	30	3450	4000	65	czarny black
IQ-LED FL-50W-NW	33883	5905339338839	50	6000	4000	65	czarny black
IQ-LED FL-90W-NW	33884	5905339338846	90	10800	4000	65	czarny black
IQ-LED FL-10W-NW-SE	33885	5905339338853	10	1200	4000	44	czarny black PIR
IQ-LED FL-20W-NW-SE	33886	5905339338860	20	2300	4000	44	czarny black PIR
IQ-LED FL-30W-NW-SE	33887	5905339338877	30	3450	4000	44	czarny black PIR
IQ-LED FL-50W-NW-SE	33888	5905339338884	50	6000	4000	44	czarny black PIR

[V]	[Hz]	\triangle	\square	\circ	\oplus	\odot	\square	\triangle	\oplus	\oplus
220-240 AC	50	100	≥ 25000	50000	$\leq 6\text{Mlx}2\text{lx}2\text{m}$	80	SMD			
$\text{[}^\circ\text{C]}$	\square	\curvearrowright	\square	\square	\square	\square	\square	\square	\square	\square
-30+50	180			0,3	1	1m				
UK CA	\downarrow									

AKCESORIA ► ACCESSORIES

IQ-LED FL QC 1 3x1MM2	33889	5905339338891	Szybkozłączka hermetyczna zapewniająca łatwe, szybkie i pewne podłączenie kabla przyłączeniowego oraz naświetlacza, IQ-LED FL QC 1 3x1MM2 (33889) Hermetic quick connector for easy, quick and safe connection of the connecting cable and the floodlight, IQ-LED FL QC 1 3x1MM2 (33889)
-----------------------	--------------	---------------	--

IQ-LED FL

NAŚWIETLACZ LED ► LED FLOODLIGHT



IQ-LED FL-10W-NW



IQ-LED FL-20W-NW



IQ-LED FL-30W-NW



IQ-LED FL-50W-NW



IQ-LED FL-90W-NW



IQ-LED FL-10W-NW-SE



IQ-LED FL-20W-NW-SE



IQ-LED FL-30W-NW-SE



IQ-LED FL-50W-NW-SE

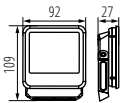

IQ-LED FL-10W-NW

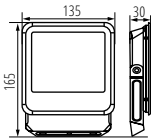

IQ-LED FL-20W-NW

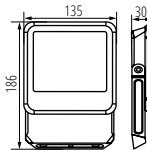

IQ-LED FL-30W-NW

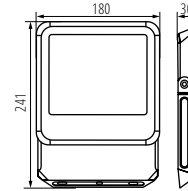

IQ-LED FL-50W-NW

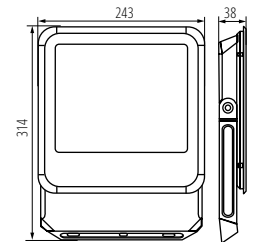

IQ-LED FL-90W-NW

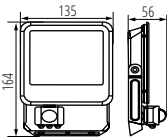

IQ-LED FL-10W-NW-SE

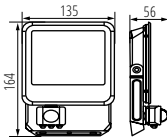

IQ-LED FL-20W-NW-SE

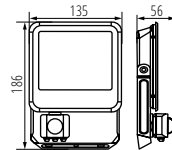

IQ-LED FL-30W-NW-SE

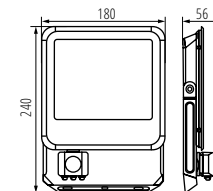

IQ-LED FL-50W-NW-SE



ANTEM LED

NAŚWIETLACZ LED ► LED FLOODLIGHT



ANTEM LED 10W-NW-SE B



ANTEM LED 20W-NW B



ANTEM LED 30W-NW B



ANTEM LED 50W-NW-SE B



Kanlux ANTEM to seria naświetlaczy LED. Te naświetlacze to przede wszystkim łatwość podłączenia, a dzięki zintegrowanej puszcze przyłączeniowej unikamy również nieestetycznego podłączenia kabla. Kanlux ANTEM LED to szeroki wybór mocy od: 10 W do 100 W, a także wersje z czujnikami ruchu i bez. Klosz z delikatną pryzmą miękko rozprasza światło i ogranicza efekt oślnienia. Wersja bez czujnika ruchu odznacza się szczelnością IP65, a wersja z czujnikiem IP44. Czujnik nastawić można w zakresie czasu świecenia, natężenia światła i obszaru detekcji.

Materiał obudowy: stop aluminium

Materiał szyby ochronnej: szkło hartowane

Materiał wysięgnika: metal

Kanlux ANTEM is a series of LED floodlights. These floodlights are above all easy to connect, and thanks to the integrated junction box you can also avoid unaesthetic cable connections. Kanlux ANTEM LED series provides a wide range of power options, from 10 W to 100 W, as well as versions with and without motion sensors. A milky lampshade with a delicate prism softly disperses light and reduces the glare effect. The version without a motion sensor has a tightness of IP65, while the one with a sensor has a tightness of IP44. The sensor can be adjusted in terms of light duration, light intensity and detection range.

Enclosure material: aluminum alloy

Protective glass material: Tempered glass

Extension-arm material: Metal



Model	Power [W]	Part No.	Beam Angle [°]	Beam Diameter [mm]	Beam Length [mm]	Beam Diameter [mm]	Beam Length [mm]	Color	Sensor
ANTEM LED 10W-NW B	33200	5905339332004	10	800	730	4000	65	czarny black	F
ANTEM LED 20W-NW B	33201	5905339332011	20	1600	1510	4000	65	czarny black	F
ANTEM LED 30W-NW B	33202	5905339332028	30	2400	2340	4000	65	czarny black	F
ANTEM LED 50W-NW B	33203	5905339332035	50	4000	4000	4000	65	czarny black	F
ANTEM LED 100W-NW B	33204	5905339332042	100	9500	8300	4000	65	czarny black	F
ANTEM LED 10W-NW-SE B	33205	5905339332059	10	800	730	4000	44	czarny black	PIR F
ANTEM LED 20W-NW-SE B	33206	5905339332066	20	1600	1510	4000	44	czarny black	PIR F
ANTEM LED 30W-NW-SE B	33207	5905339332073	30	2400	2340	4000	44	czarny black	PIR F
ANTEM LED 50W-NW-SE B	33208	5905339332080	50	4000	4000	4000	44	czarny black	PIR F

[V] 220-240 AC	[Hz] 50	120° Φ _{max}	100	≥10000	15000	≤6 MacAdam	80 Ra	SMD	IP44/IP65	PIR	House
-20+35	180	1-1,5	1m	CE	ERL	UK	Recycle				

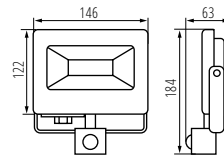

ANTEM LED 30W-NW-SE B

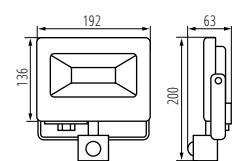

ANTEM LED 50W-NW-SE B

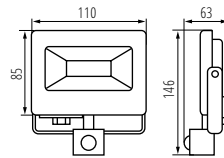

ANTEM LED 10W-NW-SE B

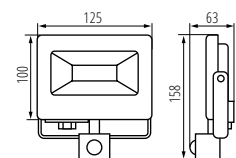

ANTEM LED 20W-NW-SE B

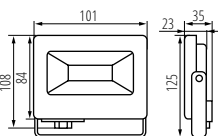

ANTEM LED 10W-NW B

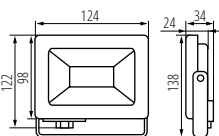

ANTEM LED 20W-NW B

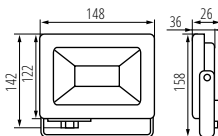

ANTEM LED 30W-NW B

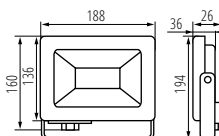

ANTEM LED 50W-NW B

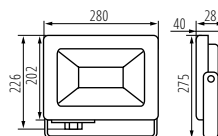

ANTEM LED 100W-NW B

Kanlux STATO LED

NAŚWIETLACZ LED ▶ LED FLOODLIGHT



STATO N LED 30W-B



STATO N LED 30W-B



STATO N LED 50W-B

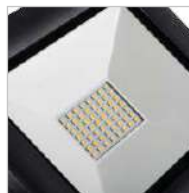

Kanlux STATO LED to przenośny naświetlacz o wysokiej szczelności (IP65). Polecany jako oświetlenie przy remontach czy pracach budowlanych. Regulacja kąta nachylenia naświetlacza i statywu pozwala na doświetlenie powierzchni w wielu płaszczyznach, wyższy współczynnik oddawania barw niż większość naświetlaczy (CRI=80) to możliwość używania wewnątrz pomieszczeń (przy remontach lepiej widać barwy oświetlanej powierzchni). W Kanlux STATO LED w komplecie znajduje się 2 metrowy kabel z wtyczką.

Materiał obudowy: stop aluminium

Materiał szyby ochronnej: szkło hartowane

Materiał wysięgnika: stal

Kanlux STATO LED is a portable floodlight with high tightness (IP65). Recommended as lighting during renovations or building works. Adjustment of the inclination angle of the floodlight and the stand allows to additionally light up surface in a lot of planes, higher colour rendering index than most floodlights (CRI=80) is a possibility of using inside rooms (during renovations, colours of lighted surface are better visible). In Kanlux STATO LED the set contains a 2-metre cable with a plug.

Enclosure material: aluminum alloy

Protective glass material: Tempered glass

Extension-arm material: steel

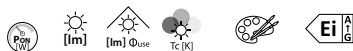

STATO N LED 30W-B	29222	5905339292223	30	3150	2770	4000	czarny black	F
STATO N LED 50W-B	29223	5905339292230	50	5250	4430	4000	czarny black	F

[V]	[Hz]	120°	[°]	[lm]	[lm]	[h]	ellipse	Ra	SMD			IP	
220-240 AC	50	Φuse	120	≥15000	25000	≤6x Macadam	80	80				65	
[°C]		[°]	IK	[m]	[mm]	[m]							
-20+35		330	07	2	1	1m							

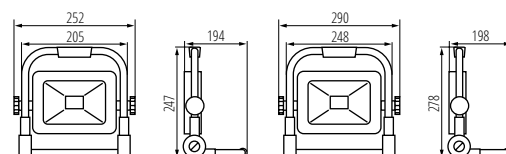

STATO N LED 30W-B

STATO N LED 50W-B

FL SONE SLR

OPRAWA SOLARNA LED ► SOLAR LED LIGHT FITTING

NEW



FL SONE SLR M NW-GR



FL SONE SLR L NW-GR



Oprawa Kanlux FL SONE SLR to naświetlacz zasilany energią słoneczną. Do wyboru mamy dwie moce naświetlacza 10/100 lub 15/150. IP65 sprawia, że są odporne na pył i zabezpieczone przed wnikaniem wody. Regulowany adapter to możliwość osobnego montażu oprawy i panelu solarnego.

Materiał obudowy: ABS
Materiał klosza: szkło

The Kanlux FL SONE SLR fixture is a solar-powered floodlight. We can choose from two floodlight power solutions: 10/100 or 15/150. IP65 makes them dust-proof and protected against water ingress. The adjustable adapter allows for separate installation of the luminaire and solar panel.

Enclosure material: ABS
Lampshade material: glass



FL SONE SLR M NW-GR	36606	5905339366061	10\100	800	4000	65
FL SONE SLR L NW-GR	36607	5905339366078	15\150	1300	4000	65

[V] 3,2 DC		 90	 ≥20000	 25000	 ellipse ≤ 6x MacAdam	
	 -10+35					

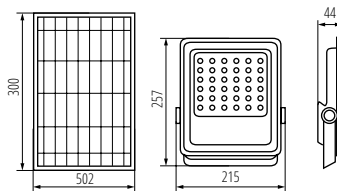

FL SONE SLR M NW-GR

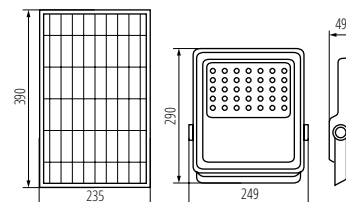

FL SONE SLR L NW-GR

FL SOLNAR SLR

OPRAWA SOLARNA LED ► SOLAR LED LIGHT FITTING



FL SOLNAR SLR 8W NW-B

Oprawa Kanlux FL SOLNAR to naświetlacz zasilany energią słoneczną. Moc naświetlacza to 8W, a jego skuteczność świetlna to 100 lm/W (kiedy oprawa jest w pełni naładowana). IP54 sprawia, że są odporne na pył i zabezpieczone przed bryzgamami wody. Regulowany adapter to możliwość osobnego montażu oprawy i panelu solarnego. Naświetlacz wyposażony jest w czujnik ruchu.

W komplecie z oprawą znajduje 2m kabel przedłużający umożliwiający montaż panelu fotowoltaicznego w pewnej odległości od oprawy.

Materiał obudowy: PC

Materiał klosza: PC

The Kanlux FL SOLNAR luminaire is a solar powered floodlight. The power of the floodlight is 8W, and its luminous efficiency is 100lm/W (when the luminaire is fully charged). IP54 allows you to install the floodlight in conditions of increased dust and moisture, as well as outdoors in places that are not roofed. The adjustable adapter makes it possible to mount the luminaire and the solar panel separately. The floodlight is equipped with a motion sensor.

The luminaire comes complete with a 2m extension cable that allows the installation of a photovoltaic panel at a certain distance from the luminaire.

Enclosure material: PC

Lampshade material: PC

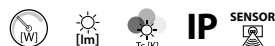

FL SOLNAR SLR 8W NW-B | 36605 | 5905339366054 | max 8 | max 800 | 4000 | 54 | PIR

3,7 DC	≥15000	20000	Ra 80	SMD	
		-15+35	max 10	120	10-1
15-1000	max 100				

	15lx - 1000lx	
1 MODE	—	max 800 lm ☀ 10s - 60s
2 MODE Night light	~40 lm	max 800 lm ☀ 10s - 60s

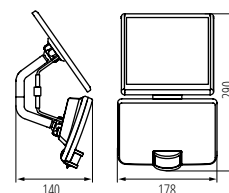

FL SOLNAR SLR 8W NW-B



STRETON LED

OPRAWA PARKINGOWA LED ► PARKING LIGHTING LED



STRETON LED 20W NW



5+
WARRANTY
5 years

IP
65

Hi
GH
efficacy

Kanlux STRETON LED to oprawy zewnętrzne przeznaczone do oświetlania parkingów czy większych powierzchni, które muszą być dobrze oświetlone również po zmroku. Ich trwałość (50.000 godzin), szczelność (IP65) i wysokie moce (do 200W) sprawiają, że Kanlux STRETON LED idealnie uzupełnią inwestycję w przestrzeni miejskiej, na parkingach, w obiektach sportowych czy placach lub skwerach.

5 lat Gwarancji na warunkach oświadczenia gwarancyjnego, dostępnego na stronie internetowej

Materiał obudowy: stop aluminium

Materiał szyby ochronnej: PC

Kanlux STRETON LED are outdoor luminaires designed to illuminate parking lots or larger areas that must be well lit also after dark. Their durability (50,000 hours), tightness (IP65) and high power (up to 200W) make Kanlux STRETON LED a perfect complement to an investment in urban space, in parking lots, in sports facilities or squares.

5 years Warranty under the terms of the warranty statement, available on our website

Enclosure material: aluminum alloy

Protective glass material: PC



Model	Code	Part No.	Power [W]	Beam Angle [°]	Height [m]	Width [m]	Depth [m]	Color	Finish	Mounting
STRETON LED 20W NW	36228	5905339362285	20	2800	4000	X140/Y90	szary grey	D		
STRETON LED 40W NW	36229	5905339362292	40	5600	4000	X140/Y90	szary grey	D		
STRETON LED 60W NW	36230	5905339362308	60	8400	4000	X140/Y90	szary grey	D		
STRETON LED 100W NW	36231	5905339362315	100	14000	4000	X140/Y90	szary grey	D		
STRETON LED 150W NW	36232	5905339362322	150	19500	4000	X140/Y90	szary grey	E		
STRETON LED 200W NW	36233	5905339362339	200	26000	4000	X140/Y90	szary grey	E		

[V] 220-240 AC	[Hz] 50	360° Φ _{use}	≥20000	50000 [h]	≤60 [mm]	70 Ra
SMD	IP 65	IK 08	0,4 [m]	1 [m]	-20+45 [°C]	CE
ERC	UK CA	RoHS				

STRETON LED

OPRAWA PARKINGOWA LED ► PARKING LIGHTING LED



STRETON LED 20W NW



STRETON LED 40W NW



STRETON LED 60W NW



STRETON LED 100W NW



STRETON LED 150W NW



STRETON LED 200W NW

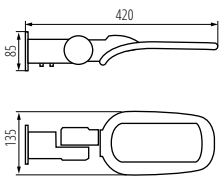

STRETON LED 20W NW

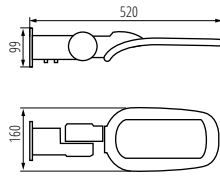

STRETON LED 40W NW

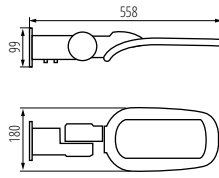

STRETON LED 60W NW

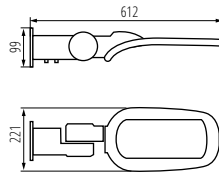

STRETON LED 100W NW

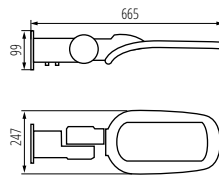

STRETON LED 150W NW

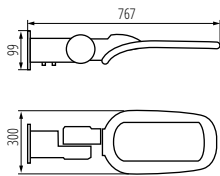

STRETON LED 200W NW



HB PRO LED HI

OPRAWA LED HIGH BAY ► HIGH-BAY LED LIGHT FITTING



HB PRO LED HI 100W-NW



HB PRO LED HI 150W-NW



HB PRO LED HI 200W-NW



HB PRO LED HI 100W-NW	27155	5905339271556	100	14000	4000	czarny black
HB PRO LED HI 150W-NW	27156	5905339271563	150	21750	4000	czarny black
HB PRO LED HI 200W-NW	27157	5905339271570	200	28000	4000	czarny black

[V]	[Hz]	[°]	[h]	[lm]	Ra	SMD	IP
220-240 AC	50	90	≥15000	30000	≤6x MacAdam	80	65
[°C]	IK	[m]	CE	ERL	UK	CA	
-20+40	08	1m					



Kanlux HB PRO HI to oprawy typu „High Bay”. Oprócz energooszczędności, jaką gwarantuje zastosowana w nich technologia LED, cechuje je też długa żywotność i wysoki stopień szczelności IP65. Idealnie sprawdzą się w wysokich halach magazynowych, produkcyjnych czy sklepowych. Dodatkowym atutem tych opraw jest zintegrowana puszką przyłączeniowa, która usprawnia montaż. Kanlux HB PRO HI to również duże strumienie świetlne i wysoka skuteczność na poziomie niemal 150 lumenów z Wata.

5 lat Gwarancji na warunkach oświadczenia gwarancyjnego, dostępnego na stronie internetowej

Materiał obudowy: stop aluminium

Materiał szyby ochronnej: tworzywo sztuczne

Kanlux HB PRO LED are “High Bay” luminaires. Apart from the energy efficiency of the applied LED technology, they are characterised by high durability and tightness of IP65. It is an excellent choice for high storage, production or shop halls. An additional advantage of these luminaires is an integrated junction box which makes the installation easier. Kanlux HB PRO HI also offers both a high luminous flux and a high luminous efficiency of 150 lm/W.

5 years Warranty under the terms of the warranty statement, available on our website

Enclosure material: aluminum alloy

Protective glass material: plastic

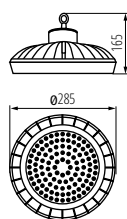

HB PRO LED HI 100W-NW

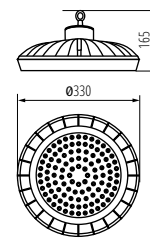

HB PRO LED HI 150W-NW

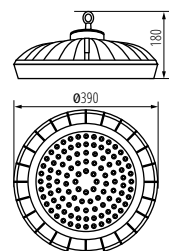

HB PRO LED HI 200W-NW

HB PRO LED HI

OPRAWA LED HIGH BAY ► HIGH-BAY LED LIGHT FITTING



HB PRO LED HI 200W



HBPH LENS 120D 100W



HBPH LENS 120D 150W



HBPH LENS 120D 200W



HBPH LENS 50D 100W



HBPH LENS 50D 150W



HBPH LENS 50D 200W



HBPH GRID 100W



HBPH GRID 150W



HBPH GRID 200W

AKCESORIA ► ACCESSORIES

HBPH LENS 120D 100W	33193	5905339331939	Soczewka 120 stopni do oprawy HB PRO HI 100W, HBPH LENS 120D 100W (33193) 120-degree lens for the HB PRO HI 100W, HBPH LENS 120D 100W light fittings (33193)
HBPH LENS 120D 150W	33194	5905339331946	Soczewka 120 stopni do oprawy HB PRO HI 150W, HBPH LENS 120D 150W (33194) 120-degree lens for the HB PRO HI 150W, HBPH LENS 120D 150W light fittings (33194)
HBPH LENS 120D 200W	33195	5905339331953	Soczewka 120 stopni do oprawy HB PRO HI 200W, HBPH LENS 120D 200W (33195) 120-degree lens for the HB PRO HI 200W, HBPH LENS 120D 200W light fittings (33195)
HBPH LENS 50D 100W	33190	5905339331908	Soczewka 50 stopni do oprawy HB PRO HI 100W, HBPH LENS 50D 100W (33190) 50-degree lens for the HB PRO HI 100W, HBPH LENS 50D 100W light fittings (33190)
HBPH LENS 50D 150W	33191	5905339331915	Soczewka 50 stopni do oprawy HB PRO HI 150W, HBPH LENS 50D 150W (33191) 50-degree lens for the HB PRO HI 150W, HBPH LENS 50D 150W light fittings (33191)
HBPH LENS 50D 200W	33192	5905339331922	Soczewka 50 stopni do oprawy HB PRO HI 200W, HBPH LENS 50D 200W (33192) 50-degree lens for the HB PRO HI 200W, HBPH LENS 50D 200W light fittings (33192)
HBPH GRID 100W	33196	5905339331960	Siatka ochronna do oprawy HB PRO LED HI 100W-NW, HBPH GRID 100W, srebrna (33196) Protective grid for the HB PRO LED HI 100W-NW, HBPH GRID 100W light fittings, silver (33196)
HBPH GRID 150W	33197	5905339331977	Siatka ochronna do oprawy HB PRO LED HI 150W-NW, HBPH GRID 150W, srebrna (33197) Protective grid for the HB PRO LED HI 150W-NW, HBPH GRID 150W light fittings, silver (33197)
HBPH GRID 200W	33198	5905339331984	Siatka ochronna do oprawy HB PRO LED HI 200W-NW, HBPH GRID 200W, srebrna (33198) Protective grid for the HB PRO LED HI 200W-NW, HBPH GRID 200W light fittings, silver (33198)

REKA LED

OPRAWA ELEWACYJNA ► FACADE LUMINAIRE



REKA LED EL 7W-L-GR



REKA LED EL 7W-O-GR



REKA LED EL 7W-L-W



REKA LED EL 7W-O-W

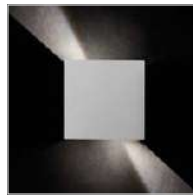
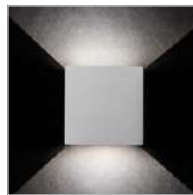

Podstawową zaletą Kanlux REKA LED jest unikatowy wizualnie efekt świetlny, który sami stworzymy po włączeniu. Dzięki skrzydłom umieszczonym na dole i na górze oprawy sami zdecydujemy o kierunku i szerokości strumienia świetlnego. Lampa Kanlux REKA świeci w dwóch kierunkach - góra i dół - a strumień świetlny możemy ustawić niezależnie od siebie tworząc na przykład idealnie cienką świetlną linię na górze, a na dole ustawiając szerokie świetlne kaskady, które będą sphywać od lampy do podłoża. Kanlux REKA LED znajdzie zastosowanie przy oświetleniu elewacji budynków, tarasów, balkonów czy zewnętrznych ścian altan.

Regulacja kąta świecenia

5 lat Gwarancji na warunkach oświadczenia gwarancyjnego, dostępnego na stronie internetowej

Materiał obudowy: stop aluminium

Materiał szyby ochronnej: szkło hartowane

The main advantage of Kanlux REKA LED is a visually unique light effect, which we create ourselves after switching on. Thanks to the wings placed at the bottom and top of the luminaire, we can decide on the direction and width of the luminous flux. The Kanlux REKA lamp shines in two directions - up and down - and the luminous flux can be set independently of each other, creating, for example, a perfectly thin line of light at the top, and at the bottom by setting wide light cascades that will flow from the lamp to the ground. Kanlux REKA LED can be used to illuminate the facades of buildings, terraces, balconies or gazebos' external walls.

Beam-angle adjustment

5 years Warranty under the terms of the warranty statement, available on our website

Enclosure material: aluminum alloy

Protective glass material: Tempered glass



REKA LED EL 7W-L-GR	28990	5905339289902	7	max 360	4000	do nadbudowania na ścianie wall mounted	grafitowy graphite	góra i dół up and down
REKA LED EL 7W-O-GR	28991	5905339289919	7	max 380	4000	do nadbudowania na ścianie wall mounted	grafitowy graphite	góra i dół up and down
REKA LED EL 7W-L-W	28992	5905339289926	7	max 500	4000	do nadbudowania na ścianie wall mounted	biały white	góra i dół up and down
REKA LED EL 7W-O-W	28993	5905339289933	7	max 510	4000	do nadbudowania na ścianie wall mounted	biały white	góra i dół up and down

[V]	[Hz]	[°]	[h]	[h]	[lm]	Ra	[lm]	[lm]	[lm]	[lm]
220-240 AC	50	max 90	≥20000	30000	≤ 6x MacAdam	80	COB	5,3	41	
IP 54	0,5m	-15+35	1	500	360°					
CE	ERC	UK CA								

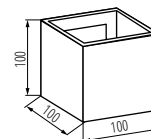

REKA LED EL-L

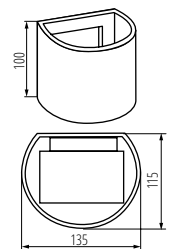

REKA LED EL 7W-O-W

Kanlux BISO LED

OPRAWA ELEWACYJNA ► FACADE LUMINAIRE



BISO LED EL 8W-GR

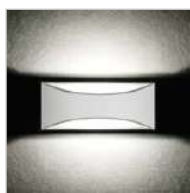

Kanlux BISO to oprawy elewacyjne, które charakteryzują się prostym i atrakcyjnym designem. Mogą być stosowane jako oprawa do wnętrz (posiadają odpowiedni współczynnik CRI), jednocześnie można stosować je na elewacjach budynku (IP54). W oprawie Kanlux BISO światło padające z modułu LED jest miękko rozpraszane na elewacji i tylnej części oprawy.

Materiał obudowy: stop aluminium

Materiał szyby ochronnej: tworzywo sztuczne

Kanlux BISO are facade fittings characterized by simple and attractive design. They can be used as a fitting for interiors (they have an appropriate CRI coefficient), at the same time they can be used on building facades (IP54). In Kanlux BISO holder light falling from the LED module is softly diffused on facade and a rear part of the holder.

Enclosure material: aluminum alloy

Protective glass material: plastic



BISO LED EL 8W-GR	29260	5905339292605	8	140	4000	do nadbudowania na ścianie wall mounted	grafitowy graphite
BISO LED EL 8W-W	29261	5905339292612	8	375	4000	do nadbudowania na ścianie wall mounted	biały white

[V]	[Hz]	[W]	[h]	[lm]	Ra	[C]	[K]	[°C]	[mm]	[IP]
220-240 AC	50	≥25000	25000	≤6xMaxdmm	80	COB	IP54	-15+40	1,5+2,5	54
0,5m										

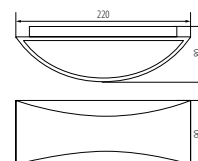

BISO LED EL 8W

Kanlux GARTO LED

OPRAWA ELEWACYJNA ► FACADE LUMINAIRE



GARTO LED EL 8W-GR



Kanlux GARTO to oprawy elewacyjne, które charakteryzują się prostym i atrakcyjnym designem. Mogą być stosowane jako oprawa do wnętrz (posiadają odpowiedni współczynnik CRI), jednocześnie można stosować je na elewacjach budynku (IP54). W oprawie Kanlux GARTO światło na elewację pada od góry i od dołu będąc równomiernie rozproszone w obu kierunkach.

Materiał obudowy: stop aluminium

Materiał szyby ochronnej: tworzywo sztuczne

Kanlux GARTO are facade fittings characterized by simple and attractive design. They can be used as a fitting for interiors (they have an appropriate CRI coefficient), at the same time they can be used on building facades (IP54). In Kanlux GARTO holder light falls on facade from upwards and from downwards being evenly diffused in both directions.

Enclosure material: aluminum alloy

Protective glass material: plastic



GARTO LED EL 8W-GR	29270	5905339292704	8	300	4000	do nadbudowania na ścianie wall mounted	grafitowy graphite
GARTO LED EL 8W-W	29271	5905339292711	8	350	4000	do nadbudowania na ścianie wall mounted	biały white

[V]	[Hz]	[W]	[h]	[lm]	Ra	[C]	[K]	[°C]	[mm]	[IP]
220-240 AC	50	≥25000	25000	≤6xMaxdmm	80	SMD	IP54	-15+40	1,5+2,5	54
0,5m										

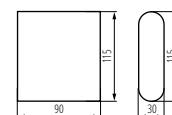

GARTO LED EL 8W



ZEW EL-235J-B



ZEW EL-235U-B



ZEW EL-235J-GR



ZEW EL-235U-GR



Oprawy Kanlux ZEW doskonale nadają się do oświetlenia elewacji budynków różnego typu, a dzięki strumieniowi światła, który skierowany jest zarówno w górę jak i w dół, kreślą one na elewacji piękne, dekoracyjne akcenty świetlne. Wysoka klasa szczelności IP44 sprawia, że oprawy można montować w miejscach bezpośrednio narażonych na działanie czynników atmosferycznych.

Materiał obudowy: stop aluminium
Materiał szyby ochronnej: szkło hartowane

Kanlux ZEW luminaires are a perfect solution for illuminating facades of buildings of various types, while the light flux directed both upwards and downwards, they create one beautiful decorative light accents on the façade. Owing to the high class of tightness (IP44), the luminaires can be mounted in places directly exposed to weather conditions.

Enclosure material: aluminum alloy
Protective glass material: Tempered glass

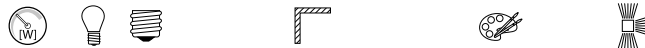

ZEW EL-235J-B	22440	5905339224408	2 x max 35	PAR16	GU10	do nadbudowania na ścianie wall mounted	czarny black	górze i dół up and down
ZEW EL-235U-B	22441	5905339224415	2 x max 35	PAR16	GU10	do nadbudowania na ścianie wall mounted	czarny black	górze i dół up and down
ZEW EL-235J-GR	22442	5905339224422	2 x max 35	PAR16	GU10	do nadbudowania na ścianie wall mounted	szary grey	górze i dół up and down
ZEW EL-235U-GR	22443	5905339224439	2 x max 35	PAR16	GU10	do nadbudowania na ścianie wall mounted	szary grey	górze i dół up and down

[V] 220-240 AC	[Hz] 50			IP 44		
 -20+35	 1+2,5					

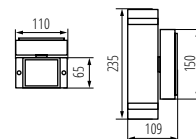

ZEW EL-235J

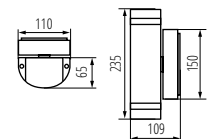

ZEW EL-235U

Kanlux

BART EL

OPRAWA ELEWACYJNA ► FACADE LUMINAIRE



BART EL-235



Kanlux BART EL to oprawa natynkowa, która świetnie wkomponuje się zarówno w elewację nowoczesnego budynku jak i zabudowania o bardziej klasycznej stylistyce. Stopień szczelności IP54, jaki posiada oprawa Kanlux BART EL gwarantuje odporność na działanie czynników atmosferycznych.

Materiał obudowy: stop aluminium
Materiał szyby ochronnej: szkło hartowane

Kanlux BART EL is a façade luminaire which perfectly blends into a modern building and constructions of a more classic style. The rating of tightness (IP54) of Kanlux BART EL luminaire ensures resistance to weather conditions.

Enclosure material: aluminum alloy
Protective glass material: Tempered glass

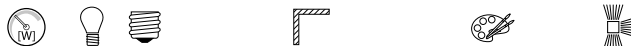

BART EL-235 | 07080 | 5905339070807 | 2 x max 35 | PAR16 | GU10 | do nadbudowania na ścianie | wall mounted | szary | grey | góra i dół | up and down

[V] 220-240 AC	[Hz] 50			IP 54	 0,5m	
 -20+35		 1+2,5	CE	ERC	UK CA	

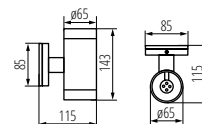

BART EL-235

Kanlux

LART EL

OPRAWA ELEWACYJNA ► FACADE LUMINAIRE



LART EL-160-GR



LART EL-260-GR



Seria elewacyjnych opraw Kanlux LART to surowa i jednocześnie klasyczna linia opraw fasadowych w obudowie wykonanej z aluminium. Powierzchnia zewnętrzna oprawy wykończona jest w kolorze antracytowym. Kanlux LART perfekcyjnie prezentują się zarówno pojedynczo, jak i w zestawieniu kilku opraw. Subtelnie tworzą lub dopełniają świetlne aranżacje na tarasach czy elewacjach budynków.

Materiał obudowy: stop aluminium
Materiał szyby ochronnej: szkło hartowane

A series of facade Kanlux LART luminaires is a raw and at the same time classic line of facade luminaires in a casing made of aluminium. The external surface of the luminaire is completed in a graphite colour. Kanlux LART look perfect both on a single basis and in combination of several luminaires - subtly complementing light arrangements on terraces or facades of buildings.

Enclosure material: aluminum alloy
Protective glass material: Tempered glass

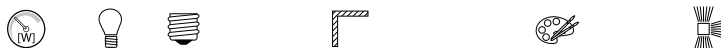

LART EL-160-GR | 29832 | 5905339298324 | max 60 | GLS/CFL/LED | E27 | do nadbudowania na ścianie | wall mounted | antracyt | anthracite | dół | down
LART EL-260-GR | 29833 | 5905339298331 | 2x max 60 | GLS/CFL/LED | E27 | do nadbudowania na ścianie | wall mounted | antracyt | anthracite | góra i dół | up and down

[V] 220-240 AC	[Hz] 50			IP 54	 0,5m	
 -20+35		 0,5+1,5	CE	ERC	UK CA	

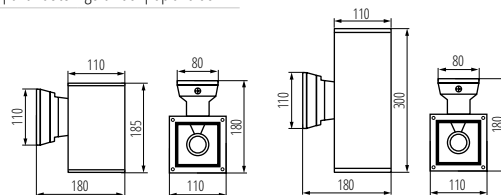

LART EL-160

LART EL-260

DULI LED

OPRAWA NAŚCIENNA ► SURFACE-MOUNTED LIGHT FITTING



DULI LED 4W-NW-L-GR



Kanlux DULI LED to seria opraw elewacyjnych, natynkowych. Nowoczesny i geometryczny design w prostej formie nadają tej serii bardzo uniwersalny charakter. Matowe wykończenie w kolorze grafitowym i najbardziej popularna temperatura barwowa dla opraw architektonicznych (4000K) to ich kolejne atuty. Kanlux DULI LED pełnią funkcję oświetlenia dekoracyjnego o charakterze akcentowym doświetlając przestrzeń wokół budynku. Oprawy natynkowe Kanlux DULI LED zasilane są napięciem 230V bez konieczności używania dodatkowego zasilacza.

Materiał obudowy: stop aluminium

Materiał szyby ochronnej: PC

Kanlux DULI LED is a series of surface-mounted, façade luminaires. Modern and geometric design in a simple form makes this series very universal. A matte graphite finish and the most popular colour temperature for architectural luminaires (4000K) are other advantages. Kanlux DULI LED is decorative accent lighting that illuminates spaces around the building. Kanlux DULI LED surface-mounted luminaires are powered by 230V without using an additional power supply unit.

Enclosure material: aluminum alloy

Protective glass material: PC



DULI LED 4W-NW-O-GR

DULI LED 6,5W-NW-L-GR

DULI LED 6,5W-NW-O-GR

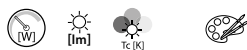

DULI LED 4W-NW-L-GR	33750	5905339337504	4	100	4000	antracyt anthracite
DULI LED 4W-NW-O-GR	33751	5905339337511	4	100	4000	antracyt anthracite
DULI LED 6,5W-NW-L-GR	33752	5905339337528	6,5	270	4000	antracyt anthracite
DULI LED 6,5W-NW-O-GR	33753	5905339337535	6,5	270	4000	antracyt anthracite

[V] 220-240 AC	[Hz] 50	 ≥25000	 30000	 80° ellipse ≤ 6x Macadam	 Ra 80
	 IP 54	 0,2m	 -15+35		
	 0,75-1,5	 360° Φuse			

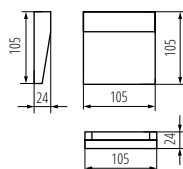

DULI LED 4W-NW-L-GR

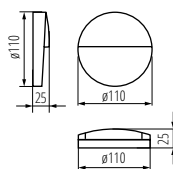

DULI LED 4W-NW-O-GR

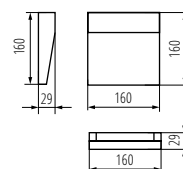

DULI LED 6,5W-NW-L-GR

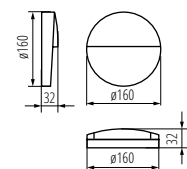

DULI LED 6,5W-NW-O-GR

Kanlux GLASI LED

OPRAWA DO WBUDOWANIA ► RECESSED LIGHT FITTING



GLASI LED 3W P WW-W

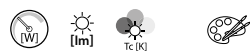

GLASI LED 3W P WW-W	33690	5905339336903	3	130	3000	biały white
GLASI LED 3W P WW-B	33691	5905339336910	3	130	3000	czarny black
GLASI LED 3W P WW-GR	33692	5905339336927	3	130	3000	grafitowy graphite
GLASI LED 3W P NW-W	33693	5905339336934	3	140	4000	biały white
GLASI LED 3W P NW-B	33694	5905339336941	3	140	4000	czarny black
GLASI LED 3W P NW-GR	33695	5905339336958	3	140	4000	grafitowy graphite

[V]	[Hz]	[°]	[h]	[lm]	Ra	SMD	[°C]	[mm]	CE	EAC	UK CA	[m]
220-240 AC	50	120	15000	30000	80	SMD	-10 : 35	96x61				
IP 44	0,1m											



GLASI LED 3W P-GR



GLASI LED 3W P-B



Kanlux GLASI LED to seria opraw do wbudowania. Prosta forma i trzy kolory obudowy (czarny, grafitowy i biały) sprawiają, że oprawy Kanlux GLASI LED doskonale sprawdzą się jako oświetlenie ścian, fasad budynków i schodów (zarówno w mieszkaniach jak i miejscach użyteczności publicznej) nadając im niepowtarzalnego charakteru.

puszka montażowa w komplecie
Materiał obudowy: stop aluminium
Materiał szyby ochronnej: szkło
Materiał panelu/ramki: PC

Kanlux GLASI LED is a series of wall-mounted light fittings. A simple form in three available colours (black, graphite and white) make Kanlux GLASI LED fittings perfect for illuminating walls, facades of buildings and stairs (both in apartments and public places), giving them a unique character.

Junction box included
Enclosure material: aluminum alloy
Protective glass material: glass
Panel/frame material: PC

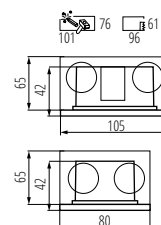

GLASI LED 3W P

Kanlux TAXI SMD

OPRAWA DO WBUDOWANIA ► RECESSED LIGHT FITTING



TAXI SMD

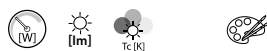

TAXI SMD L C/M-NW	26461	5905339264619	0,6	10	4000	chrom mat chrome matte
TAXI SMD P C/M-NW	26463	5905339264633	0,6	10	4000	chrom mat chrome matte

[V]	[Hz]	[h]	[lm]	Ra	SMD	[°C]	[mm]	CE	EAC	UK CA	[m]
220-240 AC	50	≥10000	20000	80	SMD	-20:35	0,22				



TAXI SMD P C/M



Kanlux TAXI SMD to ledowa oprawa akcentowa. Można ją montować zarówno wewnątrz, jak i na zewnątrz budynków (IP54). Jest to idealne rozwiązanie do dekoracyjnego podświetlania schodów lub podestów.

Materiał obudowy: metal
Materiał szyby ochronnej: szkło
Materiał panelu/ramki: stal nierdzewna

Kanlux TAXI SMD is a LED accent luminaire. It can be installed both indoors and outdoors (IP54). A perfect choice for decorative lighting of stairs and platforms.

Enclosure material: Metal
Protective glass material: glass
Panel/frame material: stainless steel

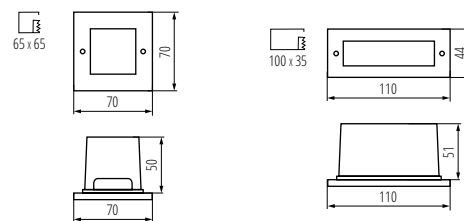

TAXI SMD L

TAXI SMD P

TURRO LED

OPRAWA NAJAZDOWA ► IN-GROUND LIGHTING FITTING



TURRO LED 3X15W-NW



Kanlux TURRO LED to wytrzymała oprawa dogruntowa z niewymiennym źródłem światła. Oprawa wykonana jest z materiałów najwyższej jakości i z dbałością o każdy szczegół. Dzięki wysokiej szczelności IP67 i odporności na uszkodzenia mechaniczne IK10 oprawa ta świetnie sprawdzi się do podświetlania podjazdów, alejek, chodników itp. Kanlux TURRO LED to także wysoki strumień świetlny, więc możemy go zastosować również w dużych przestrzeniach.

Materiał obudowy: stop aluminium
Materiał szyby ochronnej: szkło hartowane
Materiał panelu/ramki: stal nierdzewna

Kanlux TURRO LED is a durable in-ground luminaire with a non-replaceable light source. The luminaire is made of the highest quality materials and with attention to every detail. Thanks to the high IP67 tightness and resistance to mechanical damage IK10, this luminaire is perfect for illuminating driveways, alleys, sidewalks, etc. Kanlux TURRO LED also has a high luminous flux, so we can also use it in large spaces.

Enclosure material: aluminum alloy
Protective glass material: Tempered glass
Panel/frame material: stainless steel

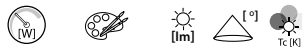

TURRO LED 3X15W-NW | **18983** | 5905339189837 | 45 | srebrny | silver | 3600 | 40 | 4000

220-240 AC	50	≥15000	30000	≤60° ≤60 Maczków	80	COB		IP 67	1m	
-20+35	IK 10		0,5	1	lm W 80					

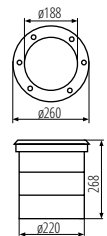

TURRO LED 3X15W-NW

Kanlux GORDO N

OPRAWA NAJAZDOWA ► IN-GROUND LIGHTING FITTING



GORDO N 1W CW-L-SR



GORDO N 1W CW-O-SR



Kanlux GORDO N to oprawa dogruntowa najazdowa ze zintegrowanym źródłem światła LED przeznaczona do wbudowania w podłoże. Wykonana jest z materiałów najwyższej jakości, dzięki czemu odporna jest na nacisk do 20kN. Szczelność oprawy to IP67.

Materiał obudowy: stop aluminium
Materiał szyby ochronnej: szkło hartowane
Materiał panelu/ramki: stal nierdzewna

Kanlux GORDO N is an overrun luminaire with an integrated LED light source for embedding into the ground. It is manufactured of best quality materials owing to which can resist pressure up to 2 tons. The tightness of the luminaire is IP67.

Enclosure material: aluminum alloy
Protective glass material: Tempered glass
Panel/frame material: stainless steel

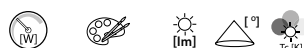

GORDO N 1W CW-L-SR	18192	5905339181923	1	srebrny silver	50	80	6500
GORDO N 1W CW-O-SR	18193	5905339181930	1	srebrny silver	50	80	6500

[V]	[Hz]		[h]		Ra		
220-240 AC	50	≥10000	20000	≤ 6x MacAdam	80	SMD	IK 08
	IP 67				[KNI]		
		0,1m		-20+35	20	IK 08	
[m]	[mm]			CE	EAC	UK CA	
0,2	0,75		50				

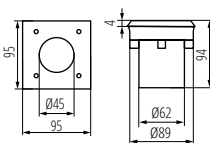

GORDO N 1W CW-L

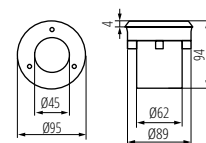

GORDO N 1W CW-O

Kanlux ROGER DL

OPRAWA DOGRUNTOWA ► IN-GROUND FIXTURE



ROGER DL-LED12



ROGER DL-2LED6



Kanlux ROGER DL to oprawa dogruntowa z wbudowanym modułem LED. Specyficzny kształt klosza rozprzodza światło równomiernie, co przekłada się na wyjątkowy efekt świetlny. Oprawa cechuje się wysokim stopniem szczelności IP66 i odporności na uszkodzenia mechaniczne IK09.

puszka montażowa w komplecie
Materiał obudowy: stal
Materiał szyby ochronnej: tworzywo sztuczne
Materiał panelu/ramki: stop aluminium

Kanlux ROGER DL is a ground-recessed luminaire with a built-in LED module. The specific shape of the shade distributes light evenly, which produces a unique light effect. The luminaire has a very high rating of tightness (IP66) and resistance to mechanical damage (IK09).

Junction box included
Enclosure material: steel
Protective glass material: plastic
Panel/frame material: aluminum alloy

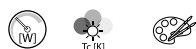

ROGER DL-LED12	07280	5905339072801	1	6000-6500	szary grey
ROGER DL-2LED6	07281	5905339072818	1	6000-6500	szary grey

[V]	[Hz]	[h]			IP 66			
220-240 AC	50	20000			66	0,1m		-20+35
	IK 09	[m]	[mm]		CE	EAC	UK CA	
		0,3	0,75					

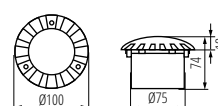

ROGER DL-LED12

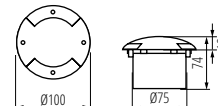

ROGER DL-2LED6

Kanlux BERG AD

OPRAWA NAJAZDOWA ► IN-GROUND LIGHTING FITTING



BERG AD-70



Kanlux BERG AD to wytrzymała oprawa dogruntowa z wymiennym źródłem światła o trzonku GU10. Świecnie sprawdza się do podświetlania podjazdów, alejek, chodników itp. Model AD to szereg nowych atutów. takich jak: podwójny przepust kablowy (możliwość łączenia przelotowego), regulowany kąt świecenia (360° horyzontalnie i 25° wertykalnie) i bardzo wysoka szczelność i ochrona (IP67, IK10). Jakość oprawy Kanlux BERG AD potwierdza pięć lat gwarancji.

5 lat Gwarancji na warunkach oświadczenia gwarancyjnego, dostępnego na stronie internetowej

Materiał obudowy: stop aluminium, tworzywo sztuczne

Materiał szyby ochronnej: szkło hartowane

Materiał panelu/ramki: stal nierdzewna

Kanlux BERG AD is a durable ground-mounted luminaire with interchangeable light source with GU10 cap. Perfect for illuminating driveways, alleys, walkways, etc. The AD model includes a number of new features such as a double cable gland (possibility of loop connection), adjustable beam angle (360° horizontally and 25° vertically) and very high protection (IP67, IK10). The quality of the Kanlux BERG AD luminaire is confirmed by a five-year warranty.

5 years Warranty under the terms of the warranty statement, available on our website

Enclosure material: aluminum alloy, plastic

Protective glass material: Tempered glass

Panel/frame material: stainless steel



BERG AD-70	36430	5905339364302	max 7	PAR16	GU10	stal nierdzewna	stainless steel
BERG AD-7L	36431	5905339364319	max 7	PAR16	GU10	stal nierdzewna	stainless steel

[V] 220-240 AC	[Hz] 50				IP 67	 0,5m	 -20+35	 25
[kN] 20	IK 10		 1-1,5		CE	ERC	UK CA	

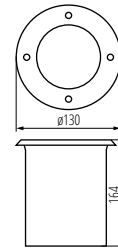

BERG AD-70

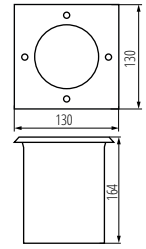

BERG AD-7L

Kanlux BERG DL

OPRAWA NAJAZDOWA ► IN-GROUND LIGHTING FITTING



BERG DL-100



Kanlux BERG to wytrzymała oprawa dogruntowa z wymiennym źródłem światła o trzonku GU10. Świecnie sprawdza się do podświetlania podjazdów, alejek, chodników itp. Wykonana jest z materiałów najwyższej jakości, dzięki czemu odporna jest na nacisk do 500 kg.

puszka montażowa w komplecie

możliwość łączenia przelotowego opraw

ułatwiona wymiana źródła światła

Materiał obudowy: stal

Materiał szyby ochronnej: szkło hartowane

Materiał panelu/ramki: stal nierdzewna

Kanlux BERG is a durable ground-recessed luminaire using a replaceable light source with an GU10 screw. It works great in illumination of driveways, alleys, sidewalks etc. It is manufactured of best quality materials owing to which can resist pressure up to 500 kg.

Junction box included

optional pass-through connection of light fixtures

easier light source replacement

Enclosure material: steel

Protective glass material: Tempered glass

Panel/frame material: stainless steel

BERG DL-100	07172	5905339071729	max 10	PAR16 LED	GU10	stal nierdzewna	stainless steel
BERG DL-10L	07173	5905339071736	max 10	PAR16 LED	GU10	stal nierdzewna	stainless steel

[V] 220-240 AC	[Hz] 50				IP 67	 0,5m	 -20+35
[kN] 5	IK 08		 1+2,5		CE	ERC	UK CA

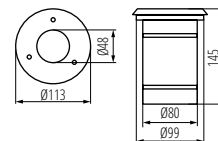

BERG DL-100

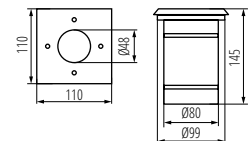

BERG DL-10L

Kanlux XARD DL

OPRAWA NAJAZDOWA ► IN-GROUND LIGHTING FITTING



XARD DL-40



XARD DL-40 | 07195 | 5905339071958 | max 40 | A60 | E27 | stal nierdzewna | stainless steel

[V] 220-240 AC	[Hz] 50			IP 67	 0,5m		 -20+35	 20
IK 10	 0,22	 1						



Oprawa dogruntowa Kanlux XARD charakteryzuje się największym stopniem odporności na uszkodzenia mechaniczne - tzw. „wandaloodporność” - IK10. Dodając do tego wysoki stopień szczelności IP67 otrzymujemy oprawę która jest świetnym rozwiązaniem dla oświetlenia elewacji budynków, skwerów, tarasów, parków, ścieżek, pasaży, podjazdów, schodów itp.

puszka montażowa w komplecie
całkowita długość źródła światła max 110mm
Materiał obudowy: stop aluminium
Materiał szyby ochronnej: szkło hartowane
Materiał panelu/ramki: stal nierdzewna

Kanlux XARD ground recessed luminaire is characterised by the highest level of resistance to mechanical damage - the so-called "vandal-resistance" - IK10. Add to this a high rating of tightness (IP67) and we get a luminaire which is a great solution for lighting facades of buildings, squares, terraces, parks, paths, passages, driveways, stairs, etc.

Junction box included
total light source length max 110 mm
Enclosure material: aluminum alloy
Protective glass material: Tempered glass
Panel/frame material: stainless steel

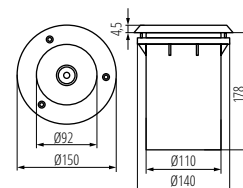

XARD DL-40

Kanlux MORO N

OPRAWA NAJAZDOWA ► IN-GROUND LIGHTING FITTING



MORO N IG-20



MORO N IG-20 | 18194 | 5905339181947 | max 20 | PAR16 | GU10 | stal nierdzewna | stainless steel

[V] 220-240 AC	[Hz] 50			IP 67	 0,5m	 -20+35	 20	IK 08
 3x1	 3x1							



Kanlux MORO N to wytrzymała oprawa dogruntowa z wymiennym źródłem światła o trzonku GU10 (max.20W). Z powodzeniem wykorzystasz ją do podświetlania podjazdów, alejek, chodników lub roślin w ogrodzie. Wykonana jest z materiałów najwyższej jakości, dzięki czemu odporna jest na nacisk 20kN. Dodatkowymi jej atutami jest szczelność na poziomie IP67 i odporność na uszkodzenia mechaniczne IK08.

Materiał obudowy: stop aluminium
Materiał szyby ochronnej: szkło hartowane
Materiał panelu/ramki: stal nierdzewna

Kanlux MORO N is a durable in-ground luminaire with a replaceable light source with GU10 cap (max.20W). You can successfully use it to illuminate driveways, alleys, sidewalks or plants in the garden. It is manufactured of best quality materials owing to which can resist pressure up to 2 tons. Its additional advantages is high rating of tightness (IP67) and (IK08) resistance to mechanical damage.

Enclosure material: aluminum alloy
Protective glass material: Tempered glass
Panel/frame material: stainless steel

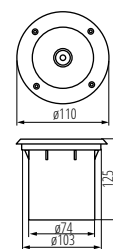

MORO N IG-20



Kanlux

ABETE LED

OPRAWA OGRODOWA LED ► LED GARDEN LIGHTING FIXTURE



NEW



ABETE LED 60 GR



ABETE LED 80 GR



ABETE LED EL 20 GR



ABETE LED EL 20 SE-GR



ABETE LED 60 GR	36570	5905339365705	7	540	4000	grafitowy graphite	na podłożu On the floor
ABETE LED 80 GR	36571	5905339365712	7	540	4000	grafitowy graphite	na podłożu On the floor
ABETE LED EL 20 GR	36572	5905339365729	7	540	4000	grafitowy graphite	do nadbudowania na ścianie wall mounted
ABETE LED EL 20 SE-GR	36573	5905339365736	7	540	4000	grafitowy graphite	do nadbudowania na ścianie wall mounted PIR

[V] 220-240 AC	[Hz] 50	≥15000	30000	ellipse ≤ 6x MacAdam	Ra 80	SMD
		IP 44	-20+35	0,2m		
lm W 77	CE	EAC	UK CA			

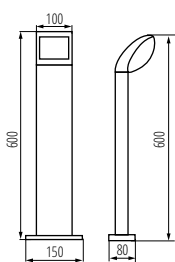

ABETE LED 60 GR

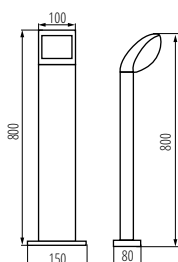

ABETE LED 80 GR

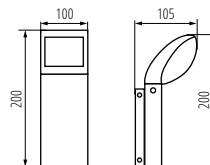

ABETE LED EL 20 GR

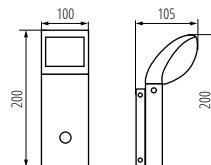

ABETE LED EL 20 SE-GR



Kanlux ABETE to oprawy zewnętrzne dla osób ceniących klasykę i prostotę. Dwa słupki o wysokości 60 i 80 cm oraz dwa kinkiety (w tym jeden z czujnikiem ruchu - SE) to uniwersalny i funkcjonalny design. Elegancka, smukła konstrukcja i mleczny klosz z tworzywa, który rozprasza światło, pozwala na szerokie i uniwersalne zastosowania lamp Kanlux ABETE zarówno do prywatnych ogrodów, a także projektów komercyjnych.

Materiał obudowy: stop aluminium
Materiał klosza: tworzywo sztuczne

Kanlux ABETE outdoor luminaires are recommended for those who appreciate classic style and simplicity. Two posts with a height of 60 and 80 cm and two wall-mounted luminaires (including one with a motion sensor - SE) are a universal and functional design. The elegant, slender design and the milky plastic light diffuser enable wide and universal use of Kanlux ABETE luminaires both in private gardens and commercial projects.

Enclosure material: aluminum alloy
Lampshade material: plastic

Kanlux PEVO

OPRAWA OGRODOWA Z WYMIENNYM ŹRÓDŁEM ŚWIATŁA
▶ GARDEN LIGHT FITTING WITH REPLACEABLE LIGHT SOURCE

NEW



PEVO 80 GR



PEVO 50 GR



PEVO EL 25 GR

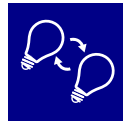

Kanlux PEVO to oświetlenie zewnętrzne o stabilnej i solidnej konstrukcji. Te oprawy idealnie sprawdzą się w ogrodach o niskiej roślinności. Zostały stworzone z myślą o terenach spacerowych, alejach i obszarach zielonych przy apartamentowcach. Słupki jak i kinkiet Kanlux PEVO dają ciekawy, nienachalny efekt świecenia. Oprawy przystosowane są do wymiennych źródeł światła o trzonku GX53, dzięki ich zastosowaniu oprawa nabiera niepowtarzalnego charakteru i wygląda jak ze źródłem zintegrowanym.

Materiał obudowy: stop aluminium

Materiał klosza: PC

Kanlux PEVO is outdoor lighting with a stable and solid construction. Those luminaires are ideal for gardens with low vegetation. They were designed for walking areas, alleys and green areas next to apartment buildings. Both the posts and the wall-mounted Kanlux PEVO luminaires give an interesting, unobtrusive lighting effect. The luminaires are adapted to replaceable light sources with a GX53 base, thanks to their use, the luminaire gains a unique character and looks like an integrated source.

Enclosure material: aluminum alloy

Lampshade material: PC



PEVO 80 GR	36550	5905339365507	max 11	LED	GX53	do nadbudowania na podłożu surface mounted	grafitowy graphite
PEVO 50 GR	36551	5905339365514	max 11	LED	GX53	do nadbudowania na podłożu surface mounted	grafitowy graphite
PEVO EL 25 GR	36552	5905339365521	max 11	LED	GX53	do nadbudowania na ścianie wall mounted	grafitowy graphite

[V] 220-240 AC	[Hz] 50				IP 44		
						1,5	0,5m

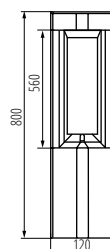

PEVO 80 GR

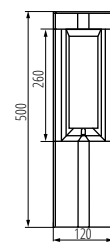

PEVO 50 GR

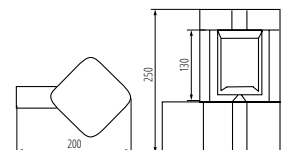

PEVO EL 25 GR

Kanlux

LAVEN

OPRAWA OGRODOWA Z WYMIENNYM ŹRÓDŁEM ŚWIATEŁA
 ► GARDEN LIGHT FITTING WITH REPLACEABLE LIGHT SOURCE

NEW



LAVEN 80 GR



LAVEN 50 GR



LAVEN EL 28 SE-GR



LAVEN EL 25 GR



Kanlux LAVEN to wyjątkowo eleganckie oświetlenie zewnętrzne. Te lampy ogrodowe to unikatowy design oparty na przydymionym kloszu połączonym z resztą oprawy ukośną linią. Ich unikalny styl podkreślają filamentowe źródła światła LED - zwłaszcza w cieplej barwie. Kołnierz u podstawy słupków Kanlux LAVEN ułatwia zamocowanie lampy w podłożu. W rodzinie tych opraw do dyspozycji mamy: dwa słupki (50 i 80cm) oraz dwa kinkiety, z których jeden (SE) ma wbudowany czujnik ruchu i zmierzchu.

Materiał obudowy: stop aluminium

Materiał klosza: PC

Kanlux LAVEN is exceptionally elegant outdoor lighting. Those garden lamps are a unique design based on a smoked lampshade connected to the rest of the luminaire with a diagonal rope. Their unique style is emphasised by filament LED light sources - especially in a warm colour. The flange at the base of the Kanlux LAVEN posts makes it easier to fix the lamp in the ground. In the family of those luminaires, there are two posts: 50 and 80 cm, and two wall-mounted luminaires, one of which (SE) has a built-in motion and twilight sensor.

Enclosure material: aluminum alloy

Lampshade material: PC



LAVEN 80 GR	36545	5905339365453	max 10	LED	E27	do nadbudowania na podłożu surface mounted	grafitowy graphite
LAVEN 50 GR	36546	5905339365460	max 10	LED	E27	do nadbudowania na podłożu surface mounted	grafitowy graphite
LAVEN EL 28 SE-GR	36547	5905339365477	max 10	LED	E27	do nadbudowania na ścianie wall mounted	grafitowy graphite PIR
LAVEN EL 25 GR	36548	5905339365484	max 10	LED	E27	do nadbudowania na ścianie wall mounted	grafitowy graphite

[V] 220-240 AC	[Hz] 50				IP 44		
0,5-1	0,2m						

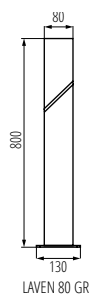

LAVEN 80 GR

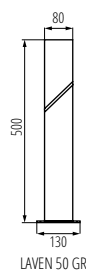

LAVEN 50 GR

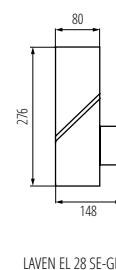

LAVEN EL 28 SE-GR

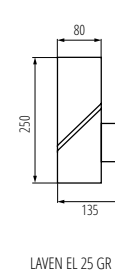

LAVEN EL 25 GR

Kanlux PRESO

OPRAWA OGRODOWA Z WYMIENNYM ŹRÓDŁEM ŚWIATŁA
► GARDEN LIGHT FITTING WITH REPLACEABLE LIGHT SOURCE

NEW



PRESO 80 GR



PRESO 50 GR



PRESO 30 GR



PRESO EL 18 GR

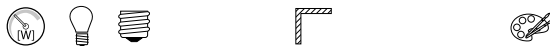

PRESO 80 GR	36540	5905339365408	max 10	LED	E27	do nadbudowania na podłożu surface mounted	grafitowy graphite
PRESO 50 GR	36541	5905339365415	max 10	LED	E27	do nadbudowania na podłożu surface mounted	grafitowy graphite
PRESO 30 GR	36542	5905339365422	max 10	LED	E27	do nadbudowania na podłożu surface mounted	grafitowy graphite
PRESO EL 18 GR	36543	5905339365439	max 10	LED	E27	do nadbudowania na ścianie wall mounted	grafitowy graphite

[V] 220-240 AC	[Hz] 50				IP 44		 -20+35
	 1,5	 0,5m					

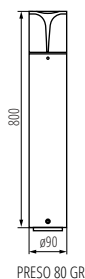

PRESO 80 GR



PRESO 50 GR

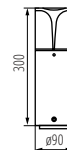

PRESO 30 GR

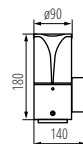

PRESO EL 18 GR



Kanlux PRESO to rodzina 4 opraw ogrodowych, wśród których znajdziemy trzy słupki o wysokościach od 30 do 80cm, a ich idealnym uzupełnieniem jest kinkiet. Dzięki specjalnej konstrukcji lampy świeca na boki, a nie do góry, co pozwala nam właściwie oświetlić pożądane miejsca. Profilowana konstrukcja klosza zapobiega utrzymywaniu się wody na powierzchni lampy. Cała seria lamp ogrodowych Kanlux PRESO dostosowana jest do wymiennych źródeł światła o trzonku E27, dlatego sami możemy wybrać odpowiednie natężenie i barwę światła.

Materiał obudowy: stop aluminium

Materiał klosza: PC

Kanlux PRESO is a family of 4 garden luminaires, among which there are three posts with heights from 30 to 80 cm, and their perfect complement is a wall-mounted luminaire. Thanks to the special design, the lamps shine sideways instead of upwards, which enables illuminating the desired areas properly. The profiled design of the lampshade prevents water from staying on the surface of the lamp. The whole series of Kanlux PRESO garden luminaires is adapted to replaceable light sources with an E27 base so we can choose the appropriate intensity and colour of light ourselves.

Enclosure material: aluminum alloy

Lampshade material: PC

Kanlux SELTO

OPRAWA OGRODOWA Z WYMIENNYM ŹRÓDŁEM ŚWIATEŁA
▶ GARDEN LIGHT FITTING WITH REPLACEABLE LIGHT SOURCE

NEW



SELTO 80 B



SELTO 50 B



SELTO EL 23 B



Prosta, nowoczesna forma zamknięta w metalu i szkle to oprawy ogrodowe Kanlux SELTO. Dzięki swoim kształtom idealnie pasują do ogrodów klasycznych jak i tych inspirowanych stylem azjatyckim (nawiązanie do kształtu pagody), dodatkowa funkcjonalność w postaci kołnierza u podstawy umożliwia łatwy montaż opraw Kanlux SELTO do podłoża. Oprawy przystosowane do źródeł światła z trzonkiem E27.



Materiał obudowy: stal nierdzewna

Materiał klosza: szkło

Kanlux SELTO garden luminaires are simple, modern forms placed inside metal and glass casings. Thanks to their shapes, they are perfect for classic gardens as well as those inspired by the Asian style (resembling a pagoda), additional functionality in the form of a flange at the base enables easy mounting of Kanlux SELTO luminaires to the ground. The luminaires are adapted to light sources with an E27 base.

Enclosure material: stainless steel

Lampshade material: glass



SELTO 80 B	36555	5905339365552	max 15	LED	E27	do nadbudowania na podłożu surface mounted	czarny black
SELTO 50 B	36556	5905339365569	max 15	LED	E27	do nadbudowania na podłożu surface mounted	czarny black
SELTO EL 23 B	36557	5905339365576	max 15	LED	E27	do nadbudowania na ścianie wall mounted	czarny black

[V] 220-240 AC	[Hz] 50				IP 44		
1,5	0,5m	CE	ERC	UK	CA		

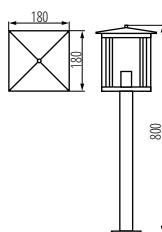

SELTO 80 B

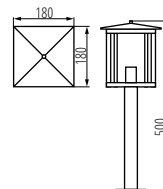

SELTO 50 B

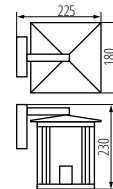

SELTO EL 23 B

Kanlux LIEGO

OPRAWA OGRODOWA Z WYMIENNYM ŹRÓDŁEM ŚWIATŁA
▶ GARDEN LIGHT FITTING WITH REPLACEABLE LIGHT SOURCE

NEW



LIEGO 97 B



LIEGO 89 PEND B



LIEGO EL 28 UP B



LIEGO EL 28 UP SE B



LIEGO 37 B



LIEGO 97 B	36530	5905339365309	max 15	LED	E27	do nadbudowania na podłożu surface mounted	czarny black
LIEGO 89 PEND B	36531	5905339365316	max 15	LED	E27	do nadbudowania na suficie ceiling mounted	czarny black
LIEGO EL 28 UP B	36532	5905339365323	max 15	LED	E27	do nadbudowania na ścianie wall mounted	czarny black
LIEGO EL 28 UP SE B	36533	5905339365330	max 15	LED	E27	do nadbudowania na ścianie wall mounted	czarny black PIR
LIEGO 37 B	36534	5905339365347	max 15	LED	E27	do nadbudowania na podłożu surface mounted	czarny black

[V] 220-240 AC	[Hz] 50				IP 44		 -20+35
	 1,5	 0,5m	CE	ERAC	UK CA		

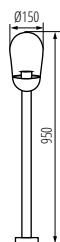

LIEGO 97 B

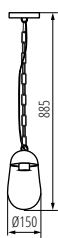

LIEGO 89 PEND B

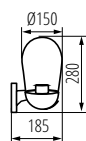

LIEGO EL 28 UP B

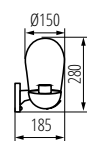

LIEGO EL 28 UP SE B

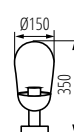

LIEGO 37 B



Lampy ogrodowe Kanlux LIEGO to efektowne, szklane klosze w owalnym kształcie, dzięki czemu możemy zastosować ozdobne LEDy typu filament, które będą stanowić dodatkową ozdobę oświetlając ogród. Zastosujemy je nie tylko w oświetleniu ogrodu, ale także w altanach, na tarasach, na patio, a kinkietami z powroźeniem oświetlimy balkon. W całej rodzinie (lampa wisząca, słupki, kinkiety) możemy zastosować wymienne źródła światła LED o gwincie E27.

Materiał obudowy: stop aluminium

Materiał klosza: szkło

Kanlux LIEGO garden luminaires are impressive oval-shaped glass lampshades, with which it is possible to use decorative LED filaments that can be an additional decoration illuminating the garden. They can be used not only to light a garden but also gazebos, terraces and patios, while the wall-mounted luminaires successfully illuminate balconies. In the whole family (pendant lamp, posts, wall-mounted), it is possible to use replaceable LED light sources with an E27 base.

Enclosure material: aluminum alloy

Lampshade material: glass

Kanlux VIMO

OPRAWA OGRODOWA Z WYMIENNYM ŹRÓDŁEM ŚWIATŁA
► GARDEN LIGHT FITTING WITH REPLACEABLE LIGHT SOURCE



VIMO EL 27 SE-B

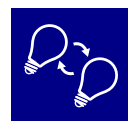

VIMO EL 27 BR; SE



VIMO 50 B; SE



VIMO 50 BR; SE



VIMO 80 B



VIMO 80 BR



Seria opraw Kanlux VIMO charakteryzuje się wyjątkowym kształtem przywodzącym na myśl lampy. Te lampy ogrodowe z wymiennym źródłem światła dostępne są w dwóch kolorach: czarny mat i brąz (miedziany). Kanlux VIMO to dwa rozmiary słupków i kinkiet, wśród których możemy też wybrać wersję z czujnikiem ruchu. Ten niekonwencjonalny kształt i klasa szczelności IP44 sprawi, że Kanlux VIMO będą się świetnie prezentować w każdym ogrodzie czy w otoczeniu domu.

Materiał obudowy: stop aluminium

Materiał klosza: PC

Kanlux VIMO luminaires series is characterised by a unique shape bringing to mind lanterns. These garden lamps with a replaceable light source are available in two colours: matte black and bronze (copper). Kanlux VIMO consists of two sizes of posts and a wall lamp, including a version with a motion sensor. This unconventional shape and IP44 tightness class will make Kanlux VIMO lamps look great in every garden or house environment.

Enclosure material: aluminum alloy

Lampshade material: PC



Model	Code	SKU	Max H	Light	Socket	Mounting	Material	Color	Feature
VIMO EL 27 B	34980	5905339349804	max 15	LED	E27	do nadbudowania na ścianie	wall mounted	czarny black	
VIMO EL 27 BR	34981	5905339349811	max 15	LED	E27	do nadbudowania na ścianie	wall mounted	brązowy brown	
VIMO EL 27 SE-B	34982	5905339349828	max 15	LED	E27	do nadbudowania na ścianie	wall mounted	czarny black	PIR
VIMO EL 27 SE-BR	34983	5905339349835	max 15	LED	E27	do nadbudowania na ścianie	wall mounted	brązowy brown	PIR
VIMO 50 B	34984	5905339349842	max 15	LED	E27	do nadbudowania na podłożu	surface mounted	czarny black	
VIMO 50 BR	34985	5905339349859	max 15	LED	E27	do nadbudowania na podłożu	surface mounted	brązowy brown	
VIMO 50 SE-B	34986	5905339349866	max 15	LED	E27	do nadbudowania na podłożu	surface mounted	czarny black	PIR
VIMO 50 SE-BR	34987	5905339349873	max 15	LED	E27	do nadbudowania na podłożu	surface mounted	brązowy brown	PIR
VIMO 80 B	34988	5905339349880	max 15	LED	E27	do nadbudowania na podłożu	surface mounted	czarny black	
VIMO 80 BR	34989	5905339349897	max 15	LED	E27	do nadbudowania na podłożu	surface mounted	brązowy brown	

[V] 220-240 AC	[Hz] 50				IP 44		 -20+40
	 1,5+2,5	 0,5m	CE	ERC	UK		

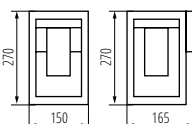

VIMO EL 27

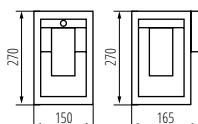

VIMO EL 27 SE

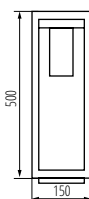

VIMO 50

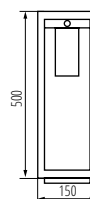

VIMO 50 SE

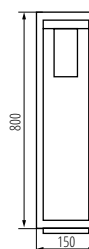

VIMO 80

Kanlux GORI

OPRAWA OGRODOWA Z WYMIENNYM ŹRÓDŁEM ŚWIATŁA
▶ GARDEN LIGHT FITTING WITH REPLACEABLE LIGHT SOURCE



GORI EL 235 D



GORI EL 235 D



GORI 50



GORI 80



GORI EL 135 D	29000	5905339290007	max 35	PAR16	GU10	dół down	antracyt anthracite
GORI EL 235 D	29001	5905339290014	2 x max 35	PAR16	GU10	górze i dół up and down	antracyt anthracite
GORI 50	29002	5905339290021	max 35	PAR16	GU10	dół down	antracyt anthracite
GORI 80	29003	5905339290038	max 35	PAR16	GU10	dół down	antracyt anthracite

[V] 220-240 AC	[Hz] 50			IP 44		 -20+35
	 1+2,5	 0,5m	CE	ERAC	UK CA	

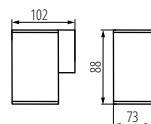

GORI EL 135

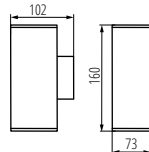

GORI EL 235

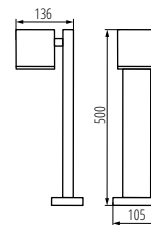

GORI 50

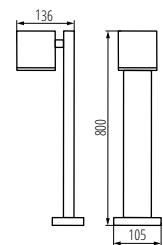

GORI 80



Oprawy ogrodowe Kanlux GORI to kompletna seria, która składa się z kinkietów i słupków. Ich kwadratowy, surowy kształt jest odpowiedzią na obecne trendy. Wszystkie oprawy Kanlux GORI posiadają wymienne źródła światła, co daje możliwość dowolnego wyboru barwy i natężenia przydomowego światła.

Materiał obudowy: stop aluminium

Materiał szyby ochronnej: szkło hartowane

Kanlux GORI garden fixtures are a complete range, they consist of wall lamps and posts. Their square, austere shape is a direct response to market trends. All Kanlux GORI fixtures are equipped with replaceable light sources which give the possibility of a free choice of light colour and intensity around the house.

Enclosure material: aluminum alloy

Protective glass material: Tempered glass

Kanlux VADRA

OPRAWA OGRODOWA Z WYMIENNYM ŹRÓDŁEM ŚWIATŁA
► GARDEN LIGHT FITTING WITH REPLACEABLE LIGHT SOURCE



VADRA 21L-UP SE



VADRA 16L-UP



VADRA 50



VADRA 80



Zewnętrzne oprawy oświetleniowe Kanlux VADRA przeznaczone są do montażu ściennego (kinkiety) lub na podłożu stałym (słupki). Kanlux VADRA posiadają wymienne źródła światła, co daje możliwość dowolnego wyboru barwy i natężenia przydomowego światła.

Maksymalna wysokość źródła światła 110mm

Materiał obudowy: stop aluminium

Materiał klosza: tworzywo sztuczne

External Kanlux VADRA fixtures are designed for wall mounting (wall lamps) or on solid ground (posts). Kanlux VADRA are equipped with replaceable light sources which give the possibility of a free choice of light colour and intensity around the house.

Maximum light-source height 110mm

Enclosure material: aluminum alloy

Lampshade material: plastic



VADRA 16L-UP	29010	5905339290106	max 11	GLS/CFL/LED	E27	do nadbudowania na ścianie wall mounted	antracyt anthracite
VADRA 21L-UP SE	29011	5905339290113	max 11	GLS/CFL/LED	E27	do nadbudowania na ścianie wall mounted	antracyt anthracite PIR
VADRA 50	29012	5905339290120	max 11	GLS/CFL/LED	E27	do nadbudowania na podłożu surface mounted	antracyt anthracite
VADRA 80	29013	5905339290137	max 11	GLS/CFL/LED	E27	do nadbudowania na podłożu surface mounted	antracyt anthracite

[V] 220-240 AC	[Hz] 50			IP 44		 -20+35	
 1,5+2,5		 0,2m	CE	ERL	UK		

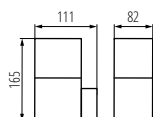

VADRA 16L

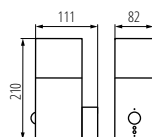

VADRA 21L

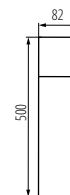

VADRA 50

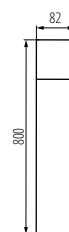

VADRA 80

INVO OP

OPRAWA ARCHITEKTONICZNA Z WYMIENNYM ŹRÓDŁEM ŚWIATŁA
 ► ARCHITECTURAL LIGHTING WITH REPLACEABLE SOURCE OF LIGHT



INVO OP 77-L-GR



INVO OP EL-53-L-GR



INVO OP 47-L-GR



INVO OP 77-L-GR



Kanlux INVO OP to seria zewnętrznych opraw architektonicznych. Cała rodzina składa się z słupków oraz oprawy elewacyjnej. W oprawach Kanlux INVO zastosujesz ulubioną barwę światła, ponieważ jest ona przystosowana do wymiennych źródeł o trzonku E27.

Mleczny klosz

Materiał obudowy: tworzywo sztuczne

Materiał klosza: tworzywo sztuczne

Kanlux INVO OP is a series of external architectural luminaires. The whole family is composed of posts and façade luminaires. You can use your favourite light colour in Kanlux INVO luminaires since it is adapted for replaceable sources with a E27 cap.

Milky lampshade

Enclosure material: plastic

Lampshade material: plastic



INVO OP EL-53-L-GR	29170	5905339291707	max 20	GLS/CFL/LED	E27	do nadbudowania na ścianie wall mounted	grafitowy graphite
INVO OP 47-L-GR	29171	5905339291714	max 20	GLS/CFL/LED	E27	do nadbudowania na podłożu surface mounted	grafitowy graphite
INVO OP 77-L-GR	29172	5905339291721	max 20	GLS/CFL/LED	E27	do nadbudowania na podłożu surface mounted	grafitowy graphite
INVO OP 107-L-GR	29173	5905339291738	max 20	GLS/CFL/LED	E27	do nadbudowania na podłożu surface mounted	grafitowy graphite

[VI] 220-240 AC	[Hz] 50				IP 54		 -20÷35
	 0,75÷1,5	 0,5m					

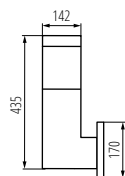

INVO OP EL-53

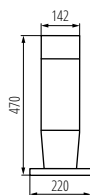

INVO OP 47

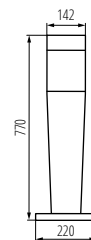

INVO OP 77

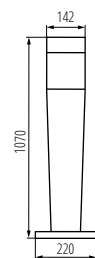

INVO OP 107

INVO TR

OPRAWA ARCHITEKTONICZNA Z WYMIENNYM ŹRÓDŁEM ŚWIATŁA
 ► ARCHITECTURAL LIGHTING WITH REPLACEABLE SOURCE OF LIGHT



INVO TR 77-O-GR



INVO TR EL-53-O-GR



INVO TR 47-O-GR



INVO TR 107-O-GR



Kanlux INVO TR to seria opraw architektonicznych z wymiennym źródłem światła GU10. Zewnętrzne słupki i oprawa elewacyjna bardzo efektywnie rozpraszają światło nie tylko w ogrodzie, ale również rozświetlą alejki, ścieżki czy trasy spacerowe. Każda oprawa posiada miejsce na 3 źródła światła.

Transparentny klosz

Materiał obudowy: tworzywo sztuczne

Materiał klosza: tworzywo sztuczne

Kanlux INVO TR is a series of architectural luminaires with a replaceable GU10 light source. External posts and is a series of external architectural luminaires offer a very effective distribution of light in the garden and lighting of alleys, paths or walking routes. Each luminaire has a space for 3 light sources.

Transparent lampshade

Enclosure material: plastic

Lampshade material: plastic



INVO TREL-53-O-GR	29174	5905339291745	3 x max 3,5	PAR16	GU10	do nadbudowania na ścianie wall mounted	grafitowy graphite
INVO TR 47-O-GR	29175	5905339291752	3 x max 3,5	PAR16	GU10	do nadbudowania na podłożu surface mounted	grafitowy graphite
INVO TR 77-O-GR	29176	5905339291769	3 x max 3,5	PAR16	GU10	do nadbudowania na podłożu surface mounted	grafitowy graphite
INVO TR 107-O-GR	29177	5905339291776	3 x max 3,5	PAR16	GU10	do nadbudowania na podłożu surface mounted	grafitowy graphite

[V] 220-240 AC	[Hz] 50				IP 54		 -20+35
	 0,75x2,5	 0,5m					

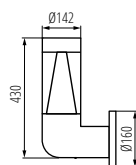

INVO TREL-53

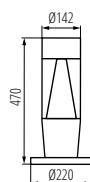

INVO TR 47

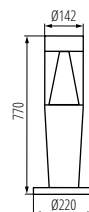

INVO TR 77

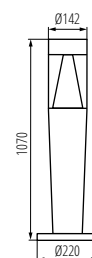

INVO TR 107

STONO N

OPRAWA OGRODOWA Z WYMIENNYM ŹRÓDŁEM ŚWIATŁA
 ► GARDEN LIGHT FITTING WITH REPLACEABLE LIGHT SOURCE



STONO 20 N



STONO 30

STONO 390 N

STONO 490 N



STONO 585 N

STONO 780 N



Oprawy Kanlux STONO N są niekwestionowanym hitem ogrodowym. To imitujące kamienie świetlne kule o średnicach od 31 do 78 cm. Idealnie wkomponują się w miejsca skalniaków czy w otoczenie krzewów. Każda z nich wyposażona jest w kolce, które pozwalają osadzić oprawę w gruncie i długi kabel zasilający (3 metry). Kanlux STONO N to oprawy na wymienne źródła światła.

w komplecie przewód 3m

w komplecie zestaw 4 szt. szpikulców do montażu w gruncie

Materiał obudowy: ABS

Materiał klosza: LLDPE

Kanlux STONO N fixtures are an undisputed garden hit. These are balls with diameters from 31 to 78 cm, imitating stones. They fit perfectly into rockeries or in the surroundings of shrubs. Each of them is equipped with spikes that allow the luminaire to be embedded in the ground and a long power cable (3 meters). Kanlux STONO N are luminaires for replaceable light sources.

a cable of 3m in a set

a set of 4 ground-mounted spikes included.

Enclosure material: ABS

Lampshade material: LLDPE



Średnica / Diameter [mm]

Model	Code	Part No.	Max Power [W]	Max Voltage [V]	Max Length [m]	Light Source	Base	Material
STONO 20 N	24654	5905339246547	max 15	200	200	GLS/CFL/LED	E27	granit Granite
STONO 30	24651	5905339246516	max 25	300	300	GLS/CFL/LED	E27	granit Granite
STONO 390 N	36591	5905339365910	max 20	390	390	GLS/CFL/LED	E27	granit Granite
STONO 490 N	36592	5905339365927	max 20	490	490	GLS/CFL/LED	E27	granit Granite
STONO 585 N	36593	5905339365934	max 20	585	585	GLS/CFL/LED	E27	granit Granite
STONO 780 N	36594	5905339365941	max 20	780	780	GLS/CFL/LED	E27	granit Granite

[V] 220-240 AC	[Hz] 50			IP 65				
			CE	EMC	RoHS			
3	1	0,2m						

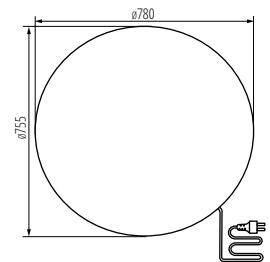

STONO 780 N

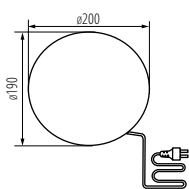

STONO 20 N

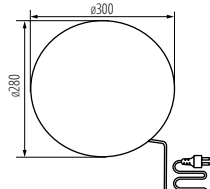

STONO 30

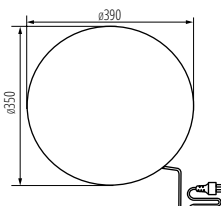

STONO 390 N

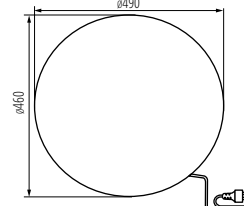

STONO 490 N

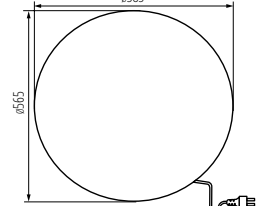

STONO 585 N



Kanlux

USTI SP

OPRAWA OGRODOWA Z WYMIENNYM ŹRÓDŁEM ŚWIATŁA
 ► GARDEN LIGHT FITTING WITH REPLACEABLE LIGHT SOURCE

NEW



USTI SP 2x7 GR



USTI SP 1x7 GR

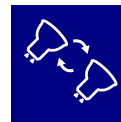

Kanlux USTI to oprawy idealne do kierunkowego podświetlania zieleni, skalniaków, elewacji czy ciekawych elementów architektonicznych, które chcemy zaakcentować. Konstrukcja z ruchomą głowicą umożliwia swobodną regulację i skierowanie światła w wybranym kierunku. Do wyboru mamy oprawę z jednym lub dwoma punktami świetlnymi (elementy świecące mogą być ustawiane niezależnie od siebie). Oprawy ogrodowe Kanlux USTI dopasowane są do źródeł światła z trzonkiem GU10.

Materiał obudowy: stop aluminium
 Materiał klosza: szkło

Kanlux USTI luminaires are ideal for directional illumination of greenery, rockeries, facades or interesting architectural elements that we want to emphasise. The design with a movable head allows you to freely adjust and direct the light in the desired way. There are two options - luminaires with one or two light points (the luminous elements can be adjusted independently of each other). Kanlux USTI garden luminaires are adapted to light sources with a GU10 base.

Enclosure material: aluminum alloy
 Lampshade material: glass



USTI SP 2x7 GR	36560	5905339365606	2 x max 7	PAR16 LED	GU10	antracyt anthracite
USTI SP 1x7 GR	36561	5905339365613	max 7	PAR16 LED	GU10	antracyt anthracite

[V] 220-240 AC	[Hz] 50			IP 54		 -20+35	
	 0,5-1	 6-7,5	 0,5m	CE	EMC	RoHS	

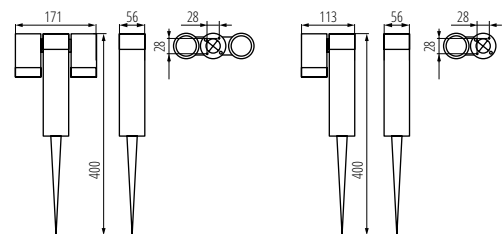

USTI SP 2x7 GR

USTI SP 1x7 GR

Kanlux VORA

OPRAWA OGRODOWA Z WYMIENNYM ŹRÓDŁEM ŚWIATŁA
▶ GARDEN LIGHT FITTING WITH REPLACEABLE LIGHT SOURCE



NEW



VORA SP 20 GR



Kanlux VORA to oprawa zewnętrzna z wymiennym źródłem światła (trzonek GU10). Jej przenośny charakter (mocowanie do podłoża za pomocą kolca) umożliwia zmianę aranżacji iluminacji świetlnej. Solidne i estetyczne wykonanie, ekskluzywny wygląd nowoczesny design, konstrukcja głowicy z kołnierzem ograniczającym rozpraszanie światła to tylko niektóre jej atuty.



Materiał obudowy: stop aluminium
Materiał szyby ochronnej: PC



Enclosure material: aluminum alloy
Protective glass material: PC



VORA SP 20 GR	36565	5905339365651	max 7	PAR16 LED	GU10	grafitowy graphite
VORA EL 20 GR	36566	5905339365668	max 7	PAR16 LED	GU10	grafitowy graphite

[V] 220-240 AC	[Hz] 50				IP 44		 -20+35

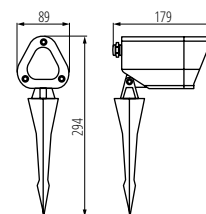

VORA SP 20 GR

Kanlux

GRIBLO 7 GR

OPRAWA OGRODOWA Z WYMIENNYM ŹRÓDŁEM ŚWIATŁA
▶ GARDEN LIGHT FITTING WITH REPLACEABLE LIGHT SOURCE

NEW



GRIBLO 7 GR



GRIBLO 7 GR | 36432 | 5905339364326 | max 7 | PAR16 LED | GU10 | antracyt | anthracite

[V] 220-240 AC	[Hz] 50			IP 65		 -20+35		 180
	[m] 1	 0,5m	CE	ERAC	UK CA			



Nowa odsłona Kanlux GRIBLO to model 7 GR, do wykorzystania jako podświetlenie niewielkich drzew, krzewów, skalniaków czy małej architektury w obrębie ogrodu. Kanlux GRIBLO 7 GR, jako jedna z nielicznych opraw na rynku, wyposażona jest w kabel zasilający zakończony wtyczką, co stanowi nie tylko udogodnienie dla użytkownika, ale również jest w zgodzie z najnowszą normą dotyczącą przenośnych opraw ogrodowych. Mocowanie oprawy do podłoża jest bardzo łatwe za pomocą „szpikulca”, który wbijamy w ziemię. Wymienne źródło światła i szczelność na poziomie IP65 to jej dodatkowe atuty.

Materiał obudowy: stop aluminium

Materiał klosza: szkło

The new Kanlux GRIBLO is model 7 GR, intended as backlighting for small trees, shrubs, rockeries or small architecture in the garden. Kanlux GRIBLO 7 GR is one of the few light fittings on the market equipped with a power cable terminated with a plug, which is not only convenient for the user but also complies with the latest standard for portable garden light fittings. Fixing it to the ground is very easy with a 'spike' hammered into the ground. A replaceable light source and IP65 water resistance are its additional strengths.

Enclosure material: aluminum alloy

Lampshade material: glass

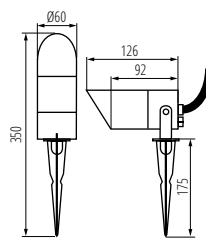

GRIBLO 7 GR

Kanlux

AKVEN LED

OPRAWA OGRODOWA Z WYMIENNYM ŹRÓDŁEM ŚWIATŁA ▶ GARDEN LIGHT FITTING WITH REPLACEABLE LIGHT SOURCE



AKVEN LED



AKVEN LED | 25720 | 5905339257208 | max 35 | MR16 | Gx5,3 | zielony | green

[V] 12 AC; 12 DC	[Hz] 50			 300	 120	 ≥15000	 25000	 3000	 ≤6w/Maxdam	 Ra 80		
IP 68		 -20+35		 180	 1-1,5	 0,5m	CE	ERAC	UK CA			



Wodoszczelna oprawa Kanlux AKVEN LED to idealne rozwiązanie do oświetlenia oczek wodnych. Wyposażona jest w wymienne źródło światła LED i przystosowana do długotrwałego zanurzenia w wodzie na głębokość do 3 metrów.

Materiał obudowy: stop aluminium

Waterproof Kanlux AKVEN LED luminaire is a perfect solution for lighting ponds. It is equipped with a replaceable LED light source and adapted to long-term immersion in water, even 3 metres deep.

Enclosure material: aluminum alloy

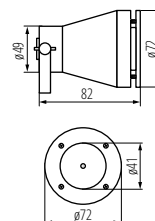

AKVEN LED

Kanlux GRL

GIRLANDA ŚWIETLNA ► STRING LIGHTS



GRL 6M5E27-B



GRL 6M5E27-B



GRL 11M10E27-B



GRL 15M15E27-B



GRL 6M5E27-B	35750	5905339357502	5 x max 10	LED	E27	czarny black
GRL 11M10E27-B	35754	5905339357540	10 x max 10	LED	E27	czarny black
GRL 15M15E27-B	35758	5905339357588	15 x max 10	LED	E27	czarny black

[V] 220-240 AC	[Hz] 50			IP 44	
 -20+40	 1,5				

AKCESORIA ► ACCESSORIES

ST45 LED 0,5W E27-NW	26046	5905339260468	Źródło światła dedykowane do girland Kanlux GRL, (26046) A light source dedicated to Kanlux GRL string lights, (26046)
ST45 LED 0,5W E27-WW	26045	5905339260451	Źródło światła dedykowane do girland Kanlux GRL, (26045) A light source dedicated to Kanlux GRL string lights, (26045)
ST45 LED 0,9W E27-BL	26039	5905339260390	Źródło światła dedykowane do girland Kanlux GRL, (26039) A light source dedicated to Kanlux GRL string lights, (26039)
ST45 LED 0,9W E27-GR	26048	5905339260482	Źródło światła dedykowane do girland Kanlux GRL, (26048) A light source dedicated to Kanlux GRL string lights, (26048)
ST45 LED 0,9W E27-RE	26049	5905339260499	Źródło światła dedykowane do girland Kanlux GRL, (26049) A light source dedicated to Kanlux GRL string lights, (26049)



Girlanda świetlna Kanlux GRL to sposób na szybkie zaaranżowanie oświetlenia wewnątrz i na zewnątrz domu. Do wyboru są trzy długości girlandy: 6, 11 i 15 metrów. Dzięki przelotowemu zasilaniu, możesz połączyć ze sobą kilka girland i stworzyć instalację o długości do 150 metrów. Do girlandy polecamy źródła światła Kanlux ST45 LED o mocy 0,5W. Girlandy Kanlux GRL wyróżniają się wysokiej jakości, bezpiecznym przewodem 1.5mm².

Rodzaj przyłącza: przewód zakończony wtyczką
Rodzaj przewodu: H07RN-F

The Kanlux GRL string lights is a way to quickly arrange lighting inside and outside the house. There are three lengths of string lights to choose from: 5, 11 and 15 meters. Thanks to the feed-through power supply, you can connect several string lights together and create an installation up to 150 meters long. For string lights, we recommend Kanlux ST45 LED 0.5W light sources. Kanlux GRL string lights are distinguished by high quality, safe 1.5mm² cable.

Connection type: Cable terminated with a plug
Wire type: H07RN-F

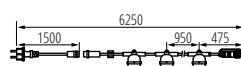

GRL 6M5E27-B

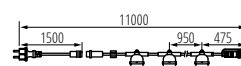

GRL 11M10E27-B

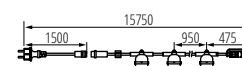

GRL 15M15E27-B

Kanlux DASTO

SŁUPEK OGRODOWY Z GNIAZDAMI 230V ► GARDEN POST WITH 230V SOCKETS

NEW



DASTO 2SOC FR B

IP



DASTO 2SOC FR B | 36585 | 5905339365859 | 44 | antracyt | anthracite

[V] 220-240 AC	In[A] 16		 1,5			
 -20+35	CE	ERC	UK CA			



Słupki przyłączeniowe Kanlux DASTO z gniazdami typu francuskiego. Dzięki ich prostej estetyce można je wkomponować w każdy typ ogrodu. Podłączysz do nich zraszacz ogrodowy, kosiarkę, grill elektryczny, girlandę świetlną, zimowe lampki na choinkę zewnętrzną lub inne, przenośne oświetlenie, które będzie Ci akurat potrzebne.

Materiał: stal nierdzewna

Kanlux DASTO / NASTO connection posts with French-type socket outlets. Thanks to their simple aesthetics, they can be integrated into any type of garden. You can connect to them a sprinkler, lawnmower, electric grill, light garland, winter lights for an outdoor Christmas tree or any other portable lighting you need.

Material: stainless steel

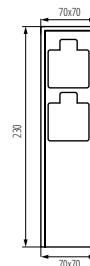

DASTO 2SOC FR B

Kanlux NASTO

SŁUPEK OGRODOWY Z GNIAZDAMI 230V ► GARDEN POST WITH 230V SOCKETS

NEW



NASTO 2SOC FR B

IP



NASTO 2SOC FR B | 36586 | 5905339365866 | 44 | antracyt | anthracite

[V] 220-240 AC	In[A] 16		 1,5			
 -20+35	CE	ERC	UK CA			



Słupki przyłączeniowe Kanlux NASTO z gniazdami typu francuskiego. Dzięki ich prostej estetyce można je wkomponować w każdy typ ogrodu. Podłączysz do nich zraszacz ogrodowy, kosiarkę, grill elektryczny, girlandę świetlną, zimowe lampki na choinkę zewnętrzną lub inne, przenośne oświetlenie, które będzie Ci akurat potrzebne.

Materiał: stal nierdzewna

Kanlux DASTO / NASTO connection posts with French-type socket outlets. Thanks to their simple aesthetics, they can be integrated into any type of garden. You can connect to them a sprinkler, lawnmower, electric grill, light garland, winter lights for an outdoor Christmas tree or any other portable lighting you need.

Material: stainless steel

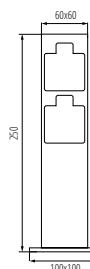

NASTO 2SOC FR B



ACORD ATL1

PROJEKTOR NA SZYNOPRZEWÓD ► TRACK LIGHT PROJECTOR



ATL1 30W



ATL1 18W



Kanlux ACORD ATL1 to zintegrowane oprawy oświetleniowe do zamontowania na szynoprzewody trójobwodowe. To lampy, które możemy dostosować do naszych indywidualnych potrzeb. Do wyboru mamy kolor biały lub czarny, dwie moce (18W i 30W), barwę światła i kąt świecenia (standardowy to 60°, jednak możemy samodzielnie wymienić reflektor i zmienić kąt na 15° lub 36°) zależnie od tego czy chcemy oświetlić powierzchnię, czy konkretny detal. Kanlux ACORD ATL1 to 50 000 godzin trwałości i 5 lat gwarancji. Markowe kluczowe komponenty (LED COB i zasilacz), wysoki poziom oddawania realnych barw (CRI>90) i wyeliminowanie efektu olśnienia (UGR <19) to kolejne zalety tych wyjątkowych opraw.

5 lat Gwarancji na warunkach oświadczenia gwarancyjnego, dostępnego na stronie internetowej
do montażu na szynoprzewodzie TEAR N

Atest PZH: Numer B-BK-60212-0487/20, ważny do 2025-12-15

Materiał obudowy: stop aluminium

Materiał szyby ochronnej: tworzywo sztuczne

Kanlux ACORD ATL1 are integrated lighting fixtures to be mounted on three-phase track. These are lamps that can be adapted to our individual needs. We can choose white or black, two powers (18W and 30W), light color and lighting angle (standard is 60°, but we can replace the reflector and change the angle to 15° or 36°) depending on whether we want to illuminate the surface or a specific detail. Kanlux ACORD ATL1 stands for 50 000 hours of durability and a 5-year warranty. Branded key components (LED COB and power supply), high level of real color rendering (CRI> 90) and elimination of glare (UGR <19) are other advantages of these unique luminaires.

5 years Warranty under the terms of the warranty statement, available on our website

for installation on the TEAR N busbar

Enclosure material: aluminum alloy

Protective glass material: plastic

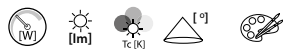

Model	Code	Power (W)	Beam Angle (°)	Beam Diameter (mm)	Beam Angle (°)	Color Rendering (CRI)	Material
ATL1 18W-930-S6-W	33130	5905339331304	18	1700	3000	60	biały white
ATL1 18W-930-S6-B	33131	5905339331311	18	1700	3000	60	czarny black
ATL1 18W-940-S6-W	33132	5905339331328	18	1800	4000	60	biały white
ATL1 18W-940-S6-B	33133	5905339331335	18	1800	4000	60	czarny black
ATL1 30W-930-S6-W	33134	5905339331342	30	2850	3000	60	biały white
ATL1 30W-930-S6-B	33135	5905339331359	30	2850	3000	60	czarny black
ATL1 30W-940-S6-W	33136	5905339331366	30	3000	4000	60	biały white
ATL1 30W-940-S6-B	33137	5905339331373	30	3000	4000	60	czarny black

[V] 220-240 AC	[Hz] 50	≥30000	(h) 50000	ellipse ≤6° Maxdram	Ra 90	COB	IP 20	House icon
5+25	315	90	0,5m	CE	ERC	PZH	UK CA	Recycling icon

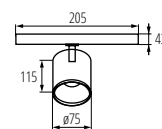

ATL1 18W-930-S6

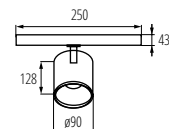

ATL1 30W-930-S6

ACORD ATLI

PROJEKTOR NA SZYNOPRZEWÓD ► TRACK LIGHT PROJECTOR



ATL1 18W



ATL1 18W



ATL1 30W



ATL1 30W

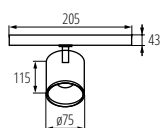

ATL1 18W-930-S6

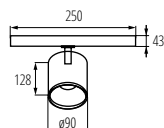

ATL1 30W-930-S6

AKCESORIA ► ACCESSORIES

REF ATL1-18W-S15	33140	5905339331403	Reflektor do oprawy ATL 1, 18W, 15 stopni Reflector for the ATL 1 luminaire, 18 W, 15 degrees
REF ATL1-18W-S36	33141	5905339331410	Reflektor do oprawy ATL 1, 18W, 36 stopni Reflector for the ATL 1 luminaire, 18 W, 36 degrees
REF ATL1-30W-S15	33142	5905339331427	Reflektor do oprawy ATL 1, 30W, 15 stopni Reflector for the ATL 1 luminaire, 30 W, 15 degrees
REF ATL1-30W-S36	33143	5905339331434	Reflektor do oprawy ATL 1, 30W, 36 stopni Reflector for the ATL 1 luminaire, 30 W, 36 degrees



Kanlux

ACORD ATL2 GU10

PROJEKTOR NA SZYNOPRZEWÓD ► TRACK LIGHT PROJECTOR



ATL2 GU10-W



ATL2 GU10-W	33138	5905339331380	biały white	GU10
ATL2 GU10-B	33139	5905339331397	czarny black	GU10

[V] 220-240 AC	[Hz] 50	[W] max 10	PAR16	IP 20	5+25	UK CA
330	100	0,5m	CE	ERC	PZH	UK CA



Kanlux ACORD ATL2 to oprawy oświetleniowe do zamontowania na szynoprzewody trójobwodowe. Do wyboru mamy biały lub czarny kolor obudowy oprawy. Typ ATL2 charakteryzuje się wymiennym źródłem światła o trzonku GU10, które możemy dostosować do naszych indywidualnych potrzeb.

5 lat Gwarancji na warunkach oświadczenia gwarancyjnego, dostępnego na stronie internetowej

do montażu na szynoprzewodzie TEAR N

Atest PZH: Numer B-BK-60212-0487/20, ważny do 2025-12-15

Materiał obudowy: stop aluminium

Kanlux ACORD ATL 2 are lighting fixtures to be mounted on three-phase track. These are lamps with a replaceable light source that can be adapted to our individual needs. We can choose the color of the fitting: white or black, and a light source. Depending on our needs, we can choose the right color, lighting angle and power. Kanlux ACORD ATL 1 luminaires have a 5-year warranty.

for installation on the TEAR N busbar

Enclosure material: aluminum alloy

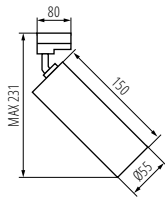

ATL2 GU10

Kanlux

ACORD ATL3 GU10

PROJEKTOR NA SZYNOPRZEWÓD ► TRACK LIGHT PROJECTOR



NEW

ATL3 GU10-B

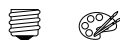

ATL3 GU10-B	33144	5905339331441	GU10 czarny black
ATL3 GU10-W	33145	5905339331458	GU10 biały white

[V] 220-240 AC	[Hz] 50	[W] max 10	PAR16	IP 20	5+25	UK CA
330	90	0,5m	CE	ERC	PZH	UK CA



Kanlux ATL3 to oprawy oświetleniowe do zamontowania na szynoprzewody trójobwodowe. Wykonane są ze stopu aluminium i charakteryzują się wymiennym źródłem światła o trzonku GU10. Oprawy Kanlux ATL3 posiadają dwie osie obrotu - poziomą 330 i pionową 90 stopni, możesz także wybrać biały lub czarny kolor oprawy. Na lampy Kanlux ACORD ATL otrzymujesz 5 lat gwarancji.

5 lat Gwarancji na warunkach oświadczenia gwarancyjnego, dostępnego na stronie internetowej

Materiał obudowy: stop aluminium

Kanlux ATL3 are lighting fixtures for installation on 3-circuit tracks. They are made of aluminum alloy and are characterized by a replaceable light source with a GU10 base. Kanlux ATL3 fixtures have two rotation axes - horizontal 330 and vertical 90 degrees, you can also choose white or black color of the fixture. You receive a 5-year warranty for Kanlux ACORD ATL lamps.

5 years Warranty under the terms of the warranty statement, available on our website

Enclosure material: aluminum alloy

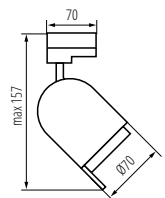

ATL3 GU10

Kanlux

ACORD ATL4 GU10

PROJEKTOR NA SZYNOPRZEWÓD ► TRACK LIGHT PROJECTOR



NEW

ATL4 GU10-B



ATL4 GU10-B	33146	5905339331465	GU10	czarny black
ATL4 GU10-W	33147	5905339331472	GU10	biały white

[V] 220-240 AC	[Hz] 50	[W] max 10	[PAR] PAR16	[IP] IP 20	[H] Household
[°C] 5+25	[°]330	[°]90	[m] 0,5m	[E] Energy	[CE]
ERC	UK				



Kanlux ATL4 to oprawy oświetleniowe do zamontowania na szynoprzewody trójobwodowe. Wykonane są ze stopu aluminium i charakteryzują się wymiennym źródłem światła o trzonku GU10. Oprawy Kanlux ATL4 posiadają dwie osie obrotu - poziomą 330 i pionową 90 stopni, możesz także wybrać biały lub czarny kolor oprawy. Na lampy Kanlux ACORD ATL otrzymujesz 5 lat gwarancji.

5 lat Gwarancji na warunkach oświadczenia gwarancyjnego, dostępnego na stronie internetowej

Materiał obudowy: stop aluminium

Kanlux ATL4 are lighting fixtures for installation on 3-circuit tracks. They are made of aluminum alloy and are characterized by a replaceable light source with a GU10 base. Kanlux ATL4 fixtures have two rotation axes - horizontal 330 and vertical 90 degrees, you can also choose white or black color of the fixture. You receive a 5-year warranty for Kanlux ACORD ATL lamps.

5 years Warranty under the terms of the warranty statement, available on our website
Enclosure material: aluminum alloy

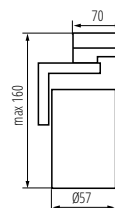

ATL4 GU10

Kanlux

ACORD ATL5 GU10

PROJEKTOR NA SZYNOPRZEWÓD ► TRACK LIGHT PROJECTOR



NEW

ATL5 GU10-W

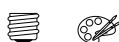

ATL5 GU10-B	33148	5905339331489	GU10	czarny black
ATL5 GU10-W	33149	5905339331496	GU10	biały white

[V] 220-240 AC	[Hz] 50	[W] max 10	[PAR] PAR16	[IP] IP 20	[H] Household
[°C] 5+25	[°]330	[°]120	[m] 0,5m	[E] Energy	[CE]
ERC	UK				



Kanlux ATL5 to oprawy oświetleniowe do zamontowania na szynoprzewody trójobwodowe. Wykonane są ze stopu aluminium i charakteryzują się wymiennym źródłem światła o trzonku GU10. Oprawy Kanlux ATL5 posiadają dwie osie obrotu - poziomą 330 i pionową 120 stopni, możesz także wybrać biały lub czarny kolor oprawy. Na lampy Kanlux ACORD ATL otrzymujesz 5 lat gwarancji.

5 lat Gwarancji na warunkach oświadczenia gwarancyjnego, dostępnego na stronie internetowej

Materiał obudowy: stop aluminium

Kanlux ATL5 are lighting fixtures for installation on 3-circuit tracks. They are made of aluminum alloy and are characterized by a replaceable light source with a GU10 base. Kanlux ATL5 fixtures have two rotation axes - horizontal 330 and vertical 120 degrees, you can also choose white or black color of the fixture. You receive a 5-year warranty for Kanlux ACORD ATL lamps.

5 years Warranty under the terms of the warranty statement, available on our website
Enclosure material: aluminum alloy

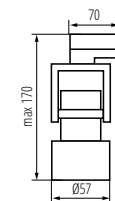

ATL5 GU10

BTL LED

PROJEKTOR NA SZYNOPRZEWÓD ► TRACK LIGHT PROJECTOR



BTL 18W-930-W



BTL 18W-930-B



BTL 18W-940-W



Kanlux BTL LED to nowy design opraw dostosowanych do systemu Kanlux TEAR i do większości systemów szyn 3-obwodowych. Oprawy wyposażone są w zasilacz zintegrowany z adapterem. Kanlux BTL to oprawy w wersji kierunkowej z soczewką i regulacją kąta świecenia w zakresie od 15° do 45°. W Kanlux BTL możemy wybrać moc (18W, 28W, 38W), kolor obudowy (biały lub czarny) i barwę światła (ciepła lub neutralna). Seria opraw Kanlux BTL posiada wysoki współczynnik oddawania barw Ra 90+, a ich wysoka jakość wykonania potwierdzona jest 5 letnią gwarancją.

5 lat Gwarancji na warunkach oświadczenia gwarancyjnego, dostępnego na stronie internetowej

Materiał obudowy: stop aluminium

Kanlux BTL LED is a new design of luminaires adapted to the Kanlux TEAR system and to the majority of 3-circuit rail systems. Luminaires are equipped with a power supply integrated with the adapter. Kanlux BTL are luminaires in the directional version with a lens and lighting angle adjustment in the range from 15° to 45°. Optionally, a diffuser with a honeycomb structure that reduces glare can be used. In Kanlux BTL we can choose the power (18W 28W 38W), the color of the housing (white or black) and the color of light (warm or neutral). The Kanlux BTL series of luminaires has a high color rendering index Ra 90+, and their high quality is confirmed by a 5-year warranty.

5 years Warranty under the terms of the warranty statement, available on our website
Enclosure material: aluminum alloy



BTL 18W-930-W	35650	5905339356505	18	1800	3000	15-45	biały white
BTL 18W-930-B	35651	5905339356512	18	1750	3000	15-45	czarny black
BTL 18W-940-W	35652	5905339356529	18	1800	4000	15-45	biały white
BTL 18W-940-B	35653	5905339356536	18	1750	4000	15-45	czarny black
BTL 28W-930-W	35654	5905339356543	28	3000	3000	15-45	biały white
BTL 28W-930-B	35655	5905339356550	28	2800	3000	15-45	czarny black
BTL 28W-940-W	35656	5905339356567	28	3000	4000	15-45	biały white
BTL 28W-940-B	35657	5905339356574	28	2800	4000	15-45	czarny black
BTL 38W-930-W	35658	5905339356581	38	4000	3000	15-45	biały white
BTL 38W-930-B	35659	5905339356598	38	3800	3000	15-45	czarny black
BTL 38W-940-W	35660	5905339356604	38	4000	4000	15-45	biały white
BTL 38W-940-B	35661	5905339356611	38	3800	4000	15-45	czarny black

[V] 220-240 AC	[Hz] 50	≥300000	(h) 50000	diffuse s/6/Max/xdm	Ra 90	COB
IP 20	5+25	340	90	0,5m	CE	ERL
UK	UK	UK	UK	UK	UK	UK

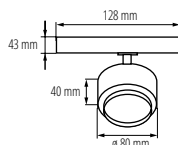

BTL 18W

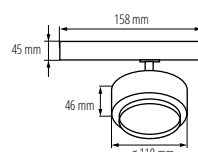

BTL 28W

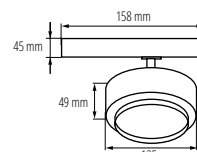

BTL 38W

BTLW LED

PROJEKTOR NA SZYNOPRZEWÓD ▶ TRACK LIGHT PROJECTOR



BTLW 18W-930-W



BTLW 18W-930-W



BTLW 18W-930-B



BTLW 18W-940-W

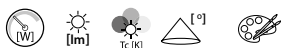

BTLW 18W-930-W	35662	5905339356628	18	1450	3000	120	biały white
BTLW 18W-930-B	35663	5905339356635	18	1400	3000	120	czarny black
BTLW 18W-940-W	35664	5905339356642	18	1450	4000	120	biały white
BTLW 18W-940-B	35665	5905339356659	18	1400	4000	120	czarny black

[V] 220-240 AC	[Hz] 50	[h] ≥30000	[h] 50000	[lm] ≤ 6x MacAdam	Ra 90	[C] COB
[IP] IP 20	[°C] 5+25	[°] 90	[m] 0.5m	[m] 0.5m	[m] 0.5m	[m] 0.5m
[m] 0.5m	[m] 0.5m	[m] 0.5m	[m] 0.5m	[m] 0.5m	[m] 0.5m	[m] 0.5m

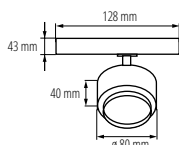

BTLW 18W-930-W

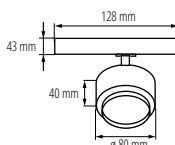

BTLW 18W-930-B

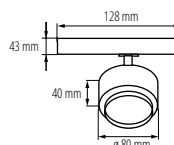

BTLW 18W-940-W

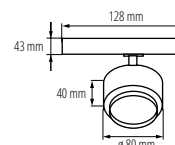

BTLW 18W-940-B

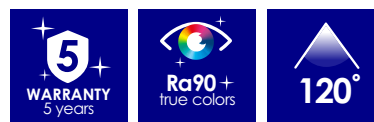

Kanlux BTLW LED to nowy design opraw dostosowanych do systemu Kanlux TEAR i do większości systemów szyn 3-obwodowych. Oprawy wyposażone są w zasilacz zintegrowany z adapterem. Kanlux BTLW charakteryzują się mlecznym kloszem rozpraszającym światło, zapewniającym szeroki kąt świecenia 120°. Dostępne są w mocy 18W, dwóch kolorach obudowy (biały lub czarny) i dwóch barwach światła. Świetnie sprawdzają się w warunkach domowych, w roli oświetlenia ogólnego oraz wszędzie tam gdzie jest potrzebny szeroki kąt świecenia oprawy.

5 lat Gwarancji na warunkach oświadczenia gwarancyjnego, dostępnego na stronie internetowej

Materiał obudowy: stop aluminium





Kanlux BTLW LED is a new design of luminaires adapted to the Kanlux TEAR rail system and to the majority of 3-circuit rail systems. Luminaires are equipped with a power supply integrated with the adapter. Kanlux BTLW are characterized by a milky lamp diffusing light, providing a wide viewing angle of 120°. They are available in 18W, two housing colors (white or black) and two light colors. They are perfect for home conditions, as general lighting and wherever a wide lighting beam angle of the luminaire is needed

5 years Warranty under the terms of the warranty statement, available on our website

Enclosure material: aluminum alloy







WERSJA NATYNKOWA / SURFACE VERSION

	TEAR N TR 1M-W	33230	5905339332301	Element systemu szynowego, TEAR N TR 1M-W, szynoprzewód 3-obwodowy, biały, (33230) Track system component, TEAR N TR 1M-W, 3-circuit track, white, (33230)
	TEAR N TR 1M-B	33231	5905339332318	Element systemu szynowego, TEAR N TR 1M-B, szynoprzewód 3-obwodowy, czarny, (33231) Track system component, TEAR N TR 1M-B, 3-circuit track, black, (33231)
	TEAR N TR 2M-W	33232	5905339332325	Element systemu szynowego, TEAR N TR 2M-W, szynoprzewód 3-obwodowy, biały, (33232) Track system component, TEAR N TR 2M-W, 3-circuit track, white, (33232)
	TEAR N TR 2M-B	33233	5905339332332	Element systemu szynowego, TEAR N TR 2M-B, szynoprzewód 3-obwodowy, czarny, (33233) Track system component, TEAR N TR 2M-B, 3-circuit track, black, (33233)
 	TEAR N PCON R-W	33234	5905339332349	Element systemu szynowego, TEAR N PCON R-W, przyłącze prądowe z wtykiem R, białe, (33234) Track system component, TEAR N PCON R-W, power connector with plug R, white, (33234)
 	TEAR N PCON R-B	33235	5905339332356	Element systemu szynowego, TEAR N PCON R-B, przyłącze prądowe z wtykiem R, czarne, (33235) Track system component, TEAR N PCON R-B, power connector with plug R, black, (33235)
 	TEAR N PCON L-W	33260	5905339332608	Element systemu szynowego, TEAR N PCON L-W, przyłącze prądowe z wtykiem L, białe, (33260) Track system component, TEAR N PCON L-W, power connector with plug L, white, (33260)
 	TEAR N PCON L-B	33261	5905339332615	Element systemu szynowego, TEAR N PCON L-B, przyłącze prądowe z wtykiem L, czarne, (33261) Track system component, TEAR N PCON L-B, power connector with plug L, black, (33261)
	TEAR N EPLUG W	33236	5905339332363	Element systemu szynowego, TEAR N EPLUG W, zaślepka, biała, (33236) Track system component, TEAR N EPLUG W, end plug, white, (33236)
	TEAR N EPLUG B	33237	5905339332370	Element systemu szynowego, TEAR N EPLUG B, zaślepka, czarna, (33237) Track system component, TEAR N EPLUG B, end cap, black, (33237)
 	TEAR N ICON-H W	33238	5905339332387	Element systemu szynowego, TEAR N ICON-H W, łącznik prosty typu „I” wewnętrzny z wtykami L i R, biały, (33238) Track system component, TEAR N ICON-H W, straight connector type „I” internal with plugs L, R, white, (33238)
 	TEAR N ICON-H B	33239	5905339332394	Element systemu szynowego, TEAR N ICON-H B, łącznik prosty typu „I” wewnętrzny z wtykami L i R, czarny, (33239) Track system component, TEAR N ICON-H B, straight connector type „I” internal with plugs L, R, black, (33239)
 	TEAR N CON-H W	33240	5905339332400	Element systemu szynowego, TEAR N CON-H W, łącznik prosty typu „I” z wtykami L i R, biały, (33240) Track system component, TEAR N CON-H W, straight connector type „I” with plugs L, R, white, (33240)
 	TEAR N CON-H B	33241	5905339332417	Element systemu szynowego, TEAR N CON-H B, łącznik prosty typu „I” z wtykami L i R, czarny, (33241) Track system component, TEAR N CON-H B, straight connector type „I” with plugs L, R, black, (33241)
 	TEAR N CON-H FLEX W	33252	5905339332523	Element systemu szynowego, TEAR N CON-H FLEX W, łącznik elastyczny z wtykami L i R, biały, (33252) Track system component, TEAR N CON-H FLEX W, flexible connector with plugs L, R, white, (33252)
 	TEAR N CON-H FLEX B	33253	5905339332530	Element systemu szynowego, TEAR N CON-H FLEX B, łącznik elastyczny z wtykami L i R, czarny, (33253) Track system component, TEAR N CON-H FLEX B, flexible connector with plugs L, R, black, (33253)
 	TEAR N CON-L RL-W	33242	5905339332424	Element systemu szynowego, TEAR N CON-L RL-W, łącznik narożny typu „L” z wtykami R i L, biały, (33242) Track system component, TEAR N CON-L RL-W, corner connector type „L” with plugs R, L, white, (33242)
 	TEAR N CON-L RL-B	33243	5905339332431	Element systemu szynowego, TEAR N CON-L RL-B, łącznik narożny typu „L” z wtykami R i L, czarny, (33243) Track system component, TEAR N CON-L RL-B, corner connector type „L” with plugs R, L, black, (33243)
 	TEAR N CON-L LR-W	33244	5905339332448	Element systemu szynowego, TEAR N CON-L LR-W, łącznik narożny typu „L” z wtykami L i R, biały, (33244) Track system component, TEAR N CON-L LR-W, corner connector type „L” with plugs L, R, white, (33244)
 	TEAR N CON-L LR-B	33245	5905339332455	Element systemu szynowego, TEAR N CON-L LR-B, łącznik narożny typu „L” z wtykami L i R, czarny, (33245) Track system component, TEAR N CON-L LR-B, corner connector type „L” with plugs L, R, black, (33245)
 	TEAR N CON-X W	33246	5905339332462	Element systemu szynowego, TEAR N CON-X W, łącznik krzyżowy z wtykami L, L, R, R, biały, (33246) Track system component, TEAR N CON-X W, cross connector with plugs L, L, R, R, white, (33246)
 	TEAR N CON-X B	33247	5905339332479	Element systemu szynowego, TEAR N CON-X B, łącznik krzyżowy z wtykami L, L, R, R, czarny, (33247) Track system component, TEAR N CON-X B, cross connector with plugs L, L, R, R, black, (33247)

		TEAR N CON-T RRL-W	33248	5905339332486	Element systemu szynowego, TEAR N CON-T RRL-W, łącznik typu „T” z wtykami R, R i L, biały, (33248) Track system component, TEAR N CON-T RRL-W, connector type „T” with plugs R, R, L, white, (33248)
		TEAR N CON-T RRL-B	33249	5905339332493	Element systemu szynowego, TEAR N CON-T RRL-B, łącznik typu „T” z wtykami R, R i L, czarny, (33249) Track system component, TEAR N CON-T RRL-B, connector type „T” with plugs R, R, L, black, (33249)
		TEAR N CON-T RLL-W	33250	5905339332509	Element systemu szynowego, TEAR N CON-T RLL-W, łącznik typu „T” z wtykami R, L i L, biały, (33250) Track system component, TEAR N CON-T RLL-W, connector type „T” with plugs R, L, L, white, (33250)
		TEAR N CON-T RLL-B	33251	5905339332516	Element systemu szynowego, TEAR N CON-T RLL-B, łącznik typu „T” z wtykami R, L i L, czarny, (33251) Track system component, TEAR N CON-T RLL-B, connector type „T” with plugs R, L, L, black, (33251)
		TEAR N CON-T LRR-W	33262	5905339332622	Element systemu szynowego, TEAR N CON-T LRR-W, łącznik typu „T” z wtykami L, R i R, biały, (33262) Track system component, TEAR N CON-T LRR-W, connector type „T” with plugs L, R, R, white, (33262)
		TEAR N CON-T LRR-B	33263	5905339332639	Element systemu szynowego, TEAR N CON-T LRR-B, łącznik typu „T” z wtykami L, R i R, czarny, (33263) Track system component, TEAR N CON-T LRR-B, connector type „T” with plugs L, R, R, black, (33263)
		TEAR N CON-T LLR-W	33264	5905339332646	Element systemu szynowego, TEAR N CON-T LLR-W, łącznik typu „T” z wtykami L, L i R, biały, (33264) Track system component, TEAR N CON-T LLR-W, connector type „T” with plugs L, L, R, white, (33264)
		TEAR N CON-T LLR-B	33265	5905339332653	Element systemu szynowego, TEAR N CON-T LLR-B, łącznik typu „T” z wtykami L, L i R, czarny, (33265) Track system component, TEAR N CON-T LLR-B, connector type „T” with plugs L, L, R, black, (33265)
		TEAR N SKIT W	33256	5905339332561	Element systemu szynowego, TEAR N SKIT W, zawieszanie z autoregulacją i linką 2m, białe, (33256) Track system component, TEAR N SKIT W, suspension with self-regulation and cord 2m, white, (33256)
		TEAR N SKIT B	33257	5905339332578	Element systemu szynowego, TEAR N SKIT B, zawieszanie z autoregulacją i linką 2m, czarne, (33257) Track system component, TEAR N SKIT B, suspension with self-regulation and cord 2m, black, (33257)
		TEAR N SCLAMP W	33254	5905339332547	Element systemu szynowego, TEAR N SCLAMP W, uchwyt montażowy/usztywniający, biały, (33254) Track system component, TEAR N SCLAMP W, mounting/stiffening suspension clamp, white, (33254)
		TEAR N SCLAMP B	33255	5905339332554	Element systemu szynowego, TEAR N SCLAMP B, uchwyt montażowy/usztywniający, czarny, (33255) Track system component, TEAR N SCLAMP B, mounting/stiffening suspension clamp, black, (33255)
		TEAR N PADAPTOR-W	33266	5905339332660	Element systemu szynowego, TEAR N PADAPTOR-W, adapter z odciążką, biały, (33266) Track system component, TEAR N PADAPTOR-W, adapter with cable relief, white, (33266)
		TEAR N PADAPTOR-B	33267	5905339332677	Element systemu szynowego, TEAR N PADAPTOR-B, adapter z odciążką, biały, (33267) Track system component, TEAR N PADAPTOR-B, adapter with cable relief, white, (33267)

NEW

WERSJA PODTYNKOWA / RECESSED VERSION

		TEAR N R-TR 2M-W	35800	5905339358004	Element systemu szynowego, TEAR N R-TR 2M-W, szynoprzewód 3-obwodowy podtynkowy, biały, (35800) Track system component, TEAR N R-TR 2M-W, 3-way flush-mounted busbar, white, (35800)
		TEAR N R-TR 2M-B	35801	5905339358011	Element systemu szynowego, TEAR N R-TR 2M-B, szynoprzewód 3-obwodowy podtynkowy, biały, (35801) Track system component, TEAR N R-TR 2M-B, 3-way flush-mounted busbar, white, (35801)
		TEAR N RC-PCON W	35790	5905339357908	Element systemu szynowego, TEAR N RC-PCON W, osłona na przyłączy prądowe, biały, (35790) Track system component, TEAR N RC-PCON W, cover for current terminal, white, (35790)
		TEAR N RC-PCON B	35791	5905339357915	Element systemu szynowego, TEAR N RC-PCON B, osłona na przyłączy prądowe, biały, (35791) Track system component, TEAR N RC-PCON B, cover for current terminal, white, (35791)
		TEAR N RC-CON-I W	35794	5905339357946	Element systemu szynowego, TEAR N RC-CON-I W, osłona na łącznik prosty typu „I”, biały, (35794) Track system component, TEAR N RC-CON-I W, cover for I-type straight connector, white, (35794)
		TEAR N RC-CON-I B	35795	5905339357953	Element systemu szynowego, TEAR N RC-CON-I B, osłona na łącznik prosty typu „I”, biały, (35795) Track system component, TEAR N RC-CON-I B, cover for I-type straight connector, white, (35795)
		TEAR N RC-CON-L W	35792	5905339357922	Element systemu szynowego, TEAR N RC-CON-L W, osłona na łącznik narożny typu „L”, biały, (35792) Track system component, TEAR N RC-CON-L W, cover for L-type corner connector, white, (35792)

TEAR N PADAPTOR

AKCESORIUM SYSTEMU SZYNOPRZEWODOWEGO
 ► ACCESSORY FOR ELECTRICAL SUPPLY TRACK SYSTEMS



TEAR N PADAPTOR-W



TEAR N PADAPTOR-B



TEAR N PADAPTOR-W	33266	5905339332660	biały white
TEAR N PADAPTOR-B	33267	5905339332677	czarny black

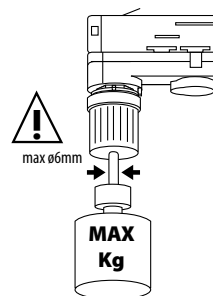
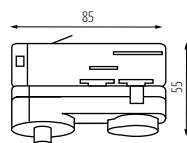

max kg	
2 x 0,75	2,2
2 x 1,00	2,9
3 x 0,75	3,3
3 x 1,00	4,4

[V] 220-240 AC	[Hz] 50	In[A] 10		IP 20		 5+25



Kanlux



OSPRZĘT KANLUX SMART KANLUX SMART EQUIPMENT

Rozwiązania Kanlux SMART są tak proste do wdrożenia, że każdy sobie z tym poradzi. Możesz połączyć je z urządzeniami, których już teraz używasz na co dzień – takimi jak lampy, grzejniki, armatura – albo wprowadzić zupełnie nowe urządzenia – na przykład czujniki. Dzięki temu inteligentne sterowanie domem zaczynasz od zaraz – bez remontów, przebudowy i kucia ścian.

Kanlux SMART devices are so easy to configure, anybody can do it. You can use them with other devices you are already using - lamps, heaters, outlets - as well as add new devices, like sensors. That lets you start control your home right now - no renovations, reconstructions and hammering the walls.



*dane fotometryczne znajdziesz na:
photometric data you can find on:*

► kanlux.com

Steruj produktami Kanlux SMART za pomocą aplikacji mobilnej SMART LIFE

Control Kanlux SMART products
with the SMART LIFE mobile application



Kanlux

KANLUX SMART

CZUJNIK OTWARCIA ► DOOR/WINDOW SENSOR



S SENSOR ON/OFF INT



S SENSOR ON/OFF INT | 34942 | 5905339349422 | 2 x 1,5 DC | 2 x AAA

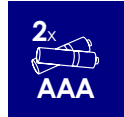
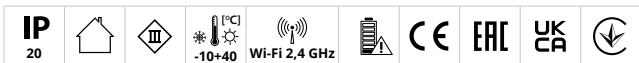

Otwarte okno lub drzwi na taras - często zastanawiamy się czy je zamknęliśmy po wyjściu z domu. Czujnik otwarcia okna/drzwi pokaże nam ich stan. Montując go na drzwiach wejściowych, tarasowych, balkonowych lub na oknie, w czasie wyjazdu nie musimy się zastanawiać czy w domu na pewno wszystko jest w porządku. Czujnik skontroluje okna i drzwi, a o ewentualnym otwarciu dowiemy się z aplikacji w naszym urządzeniu mobilnym. O niskim poziomie naładowania baterii poinformuje nas alarm. Dowiedz się więcej o Kanlux SMART na www.kanluxsmart.com.

An open window or terrace door - each of us often wonders if we closed them after leaving the house. The window/door opening sensor will show you their status. By mounting it on the front, terrace, balcony or door, or on the window, you don't have to wonder if everything is alright at home when you go for a trip. The sensor will inspect the windows and doors, and an app on your mobile device will notify you if any of them is opened. An alarm will let you know when the battery is low. Learn more about Kanlux SMART at www.kanluxsmart.com.

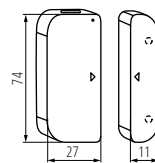

S SENSOR ON/OFF INT

Kanlux

KANLUX SMART

CZUJNIK RUCHU PIR ► PIR MOTION SENSOR



S SENSOR PIR INT 10M



S SENSOR PIR INT 10M | 34940 | 5905339349408 | 2 x 3V DC / 5V USB | 2 x CR123A



Czujnik detekcji ruchu do użytku wewnątrz pomieszczeń. Poprzez połączenie go w aplikacji z wybranymi urządzeniami SMART, nie tylko zapali światło po wykryciu ruchu, ale uruchomi dowolnie zaprogramowaną czynność - zależnie od sparowanych urządzeń SMART i przypisanej im funkcji. Czujnik posiada zasilanie bateryjne, jak również możliwość ładowania przez USB. O niskim poziomie naładowania baterii poinformuje nas alarm. Dowiedz się więcej o Kanlux SMART na www.kanluxsmart.com.

Motion detection sensor for indoor use. By pairing it in the app with selected SMART devices, it will not only turn on the light when motion is detected but it will also trigger any programmed action - depending on the SMART devices paired and the function assigned to them. The sensor is battery powered but it can also be charged via USB. An alarm will let you know when the battery is low. Learn more about Kanlux SMART at www.kanluxsmart.com.

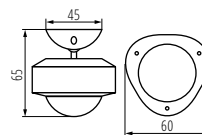

S SENSOR PIR INT 10M

Kanlux

KANLUX SMART

CZUJNIK ZALANIA ► FLOOD SENSOR



S SENSOR W INT



S SENSOR W INT | 34941 | 5905339349415 | 2 x 1,5 DC | 2 x AAA



CzuJNIK zalania pomoże nam zareagować na wodę wyciekającą z pękniętej rury, niezakręconego kranu lub niezależnego od nas zalania domu czy mieszkania. CzuJNIK należy umieścić w takim miejscu, aby w przypadku zalania mógł wykryć wodę. Ma on wbudowany alarm akustyczny, ale informację z aplikacji dostaniemy również w urządzeniu mobilnym, nawet będąc daleko od domu. O niskim poziomie naładowania baterii poinformuje nas alarm. Dowiedz się więcej o Kanlux SMART na www.kanluxsmart.com.

A flood sensor will help you react to water leaking from a broken pipe, a running faucet, or in the event of flooding in the house or apartment caused by external factors. The sensor should be placed in such a location as to enable water detection in the event of flooding. It has a built-in acoustic alarm, but you will also get the information from the app on your mobile device, even when you are away from home. The alarm will let you know when the battery is low. Learn more about Kanlux SMART at www.kanluxsmart.com.

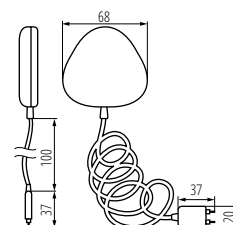

S SENSOR W INT



Kanlux

KANLUX SMART

ADAPTER GNIAZDA ► SOCKET ADAPTOR



S AD GN SCH 10A PM



S AD GN 16A PM

Dzięki adapterowi gniazda możemy sterować (funkcja włącz/wyłącz) urządzeniami bez funkcji SMART (np.: żelazko). Możemy również ustawić wybraną przez nas sekwencję czynności. Podstawowa funkcja to włącz/wyłącz, ale adapter ma także wbudowany zegar (tygodniowy z kalendarzem), funkcje losowe i funkcję licznika / odliczania. Dzięki temu możemy zaprogramować włączanie i wyłączanie różnych urządzeń o określonych porach, nawet kiedy nie ma nas w domu. Dodatkowo adapter posiada funkcję pomiaru zużycia energii (podłączonego do niego urządzenia). Dowiedz się więcej o Kanlux SMART na www.kanluxsmart.com.

Thanks to the socket adapter, you can control (on/off function) devices without SMART functions (e.g.: an iron). We can also set a sequence of actions of our choice. The basic function is on/off, but the adapter also has a built-in clock (weekly clock with a calendar), random functions and a timer/countdown function. This allows you to program different devices to turn on and off at specific times, even when you are not at home. In addition, the adapter has a function to measure the energy consumption (of the device connected to it). Learn more about Kanlux SMART at www.kanluxsmart.com.

			In [A]
S AD GN SCH 10A PM	33701	5905339337016	10
S AD GN 16A PM	33703	5905339337030	16

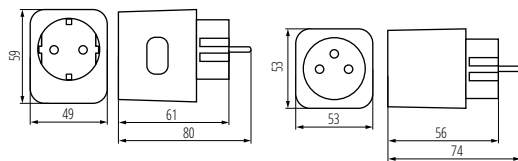

S AD GN SCH 10A PM

S AD GN 16A PM



Kanlux

KANLUX SMART

STEROWNIK BRAMY GARAŻOWEJ ► GARAGE DOOR RELAY



S SWITCH G DOOR



S SWITCH G DOOR | 34950 | 5905339349507 | biały | white



Przełącznik do sterowania bramą z czujnikiem otwarcia i zamknięcia. Może współpracować w środowisku smart z innymi przyciskami dedykowanymi bądź wirtualnymi przez przypisanie funkcji - takie jak zamknij czy otwórz. Dowiedz się więcej o Kanlux SMART na www.kanluxsmart.com.

Relay for controlling gates with an open and close sensor. It can work in a smart environment with other dedicated or virtual buttons by assigned functions - such as close or open. Learn more about Kanlux SMART at www.kanluxsmart.com.

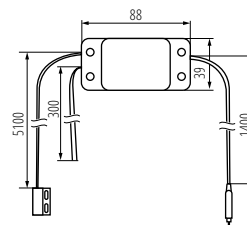

S SWITCH G DOOR

Kanlux

KANLUX SMART

PRZEKĄŹNIK DOPUSZKOWY ► SWITCHBOX RELAY



S SWITCH ON/OFF



S SWITCH ON/OFF | 34948 | 5905339349484 | biały | white



Przełącznik on/off montowany podtynkowo (puszki fi 60). Umożliwia nam sterowanie obwodami gniazd wtykowych lub włączników światła nadając im funkcję SMART bez konieczności prowadzenia dodatkowej instalacji pomiędzy nimi. Dowiedz się więcej o Kanlux SMART na www.kanluxsmart.com.

Flush-mounted on/off relay (fi 60 boxes). It allows you to control the circuits of plug-in sockets or light switches, giving them the SMART function without requiring additional installation between them. Learn more about Kanlux SMART at www.kanluxsmart.com.

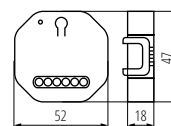

S SWITCH ON/OFF

Kanlux

KANLUX SMART

PRZEKĄŹNIK DOPUSZKOWY ► SWITCHBOX RELAY



S SWITCH SHUTTER



S SWITCH SHUTTER | 34949 | 5905339349491 | biały | white



Przełącznik do sterowania silnikami rolet i żaluzji montowany podtynkowo (puszki fi 60). Umożliwia nam sterowanie roletami z poziomu aplikacji zainstalowanej na urządzeniu mobilnym. Dowiedz się więcej o Kanlux SMART na www.kanluxsmart.com.

Relay for controlling motors of flush-mounted roller blinds and shutters (fi 60 boxes). It allows you to control roller blinds from the level of the application installed on your mobile device. Learn more about Kanlux SMART at www.kanluxsmart.com.

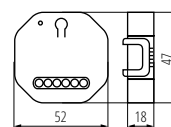

S SWITCH SHUTTER

Kanlux



OSPRZĘT ELEKTROINSTALACYJNY
ELECTRICAL INSTALLATION EQUIPMENT

Zależy Ci na właściwie dobranych parametrach, wydajności i zabezpieczeniu termicznym, zwarciovym i przeciążeniowym. My dajemy Ci produkty przeznaczone do tych zadań. Zapewniamy komfort, niezawodność i bezpieczeństwo.

You want the properly adjusted parameters, efficiency and thermal, short-circuit and overload protection. We give you products designed for these tasks. We ensure comfort, reliability and safety.



*dane fotometryczne znajdziesz na:
photometric data you can find on:*

► kanlux.com

Kanlux

SQMOTION

CZUJNIK RUCHU MW ▶ MW MOTION SENSOR



SQMOTION-W



SQMOTION-B

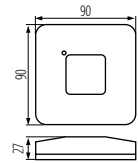
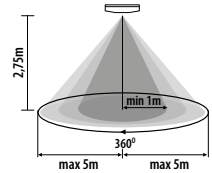

SQMOTION

Czujnik ruchu mikrofalowy, nowoczesny design sprawia, że świetnie prezentuje się w każdej aplikacji. Dostępny w dwóch kolorach, montaż natynkowy.

Materiał: tworzywo sztuczne

Microwave motion sensor, modern design makes it look great in any application. Available in two colors, surface-mounted installation.

Materiał: plastic

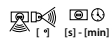

SQMOTION-W	37360	5905339373601	800	do nadbudowania na suficie, do nadbudowania na ścianie ceiling mounted, wall mounted	360	10-12	mikrofalowy microwave
SQMOTION-B	37361	5905339373618	800	do nadbudowania na suficie, do nadbudowania na ścianie ceiling mounted, wall mounted	360	10-12	mikrofalowy microwave

[V]	[Hz]	IP	🏠	📐	📏 [m]	🌞 [lx]	🌡️ [°C]	📦	📏 [mm]	CE	EAC	UK CA	🌱
220-240 AC	50	20			max 8	3-2000	5+25		0,75+1,5				

Kanlux

ALER-N

CZUJNIK RUCHU PIR ▶ PIR MOTION SENSOR



ALER N-W



ALER N-B

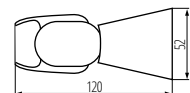
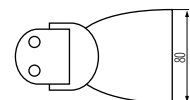
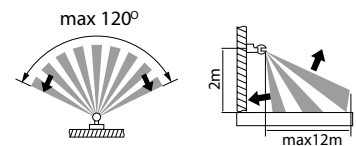

ALER N

Najnowszy model czujnika ruchu na podczerwień w rodzinie ALER. Maksymalny zasięg wykrywania 12m oraz wysoki stopień IP65 czynią go rozwiązaniem uniwersalnym do wielu zastosowań. Dostępny w dwóch kolorach, montaż na ścianie.

Materiał: tworzywo sztuczne

The latest model of an infrared motion sensor in the ALER family. A maximum detection range of 12m and a high IP65 rating make it a versatile solution for many applications. Available in two colors, wall-mounted installation.

Materiał: plastic



ALER N-W	37362	5905339373625	1200	do nadbudowania na ścianie wall mounted	120	PIR	10-15
ALER N-B	37363	5905339373632	1200	do nadbudowania na ścianie wall mounted	120	PIR	10-15

[V]	[Hz]	IP	🏠	📐	📏 [m]	🌞 [lx]	🌡️ [°C]	📦	📏 [mm]	CE	EAC	UK CA	🌱
220-240 AC	50	65			max 12	3-2000	-20+40		0,75+1,5				

Kanlux

ZONA MINI

CZUJNIK RUCHU PIR ► PIR MOTION SENSOR



ZONA MINI

Czujnik ruchu na podczerwień ZONA MINI dzięki swoim kompaktowym wymiarom (średnica zaledwie 76mm) idealnie i subtelnie wkomponuje się w każde pomieszczenie.

Materiał: tworzywo sztuczne

The ZONA MINI infrared motion sensor, thanks to its compact dimensions (only 76mm in diameter), will perfectly and subtly blend into any room.

Materiał: plastic

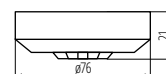
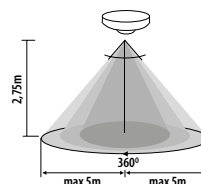

ZONA MINI-W | **37364** | 5905339373649 | 200 | do nadbudowania na suficie | ceiling mounted | H360 | PIR | 10-15

[V] 220-240 AC	[Hz] 50	IP 20			 max 8	 3-2000	 5+25	 0,75+1,5				
--------------------------	-------------------	-----------------	--	--	-----------	------------	----------	--------------	--	--	--	--

ZONA MINI

Kanlux

ZONA MINI WT

CZUJNIK RUCHU PIR ► PIR MOTION SENSOR



ZONA MINI WT

ZONA MINI WT to rozszerzenie rodziny kompaktowych czujników ruchu na podczerwień. Wersję WT (watertight) cechuje wysoki stopień IP65 co dodatkowo rozszerza jego zakres zastosowania.

Materiał: tworzywo sztuczne

ZONA MINI WT is an extension of the family of compact infrared motion sensors. The WT (watertight) version is characterized by a high IP65 rating, further expanding its range of applications.

Materiał: plastic

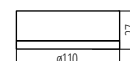
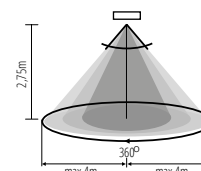

ZONA MINI WT-W | **37365** | 5905339373656 | 2000 | do nadbudowania na suficie | ceiling mounted | H360 | PIR | 10-30

[V] 220-240 AC	[Hz] 50	IP 65/20			 max 8	 3-2000	 -20+40	 0,75+1,5				
--------------------------	-------------------	--------------------	--	--	-----------	------------	------------	--------------	--	--	--	--

ZONA MINI WT

Kanlux

SENTO-O

CZUJNIK RUCHU PIR ► PIR MOTION SENSOR



SENTO-O-WT-W



SENTO-O-WT-B

Kanlux SENTO-O to czujnik elektroniczny służący do wykrywania ruchu. Jego wyjątkowość polega na zabudowaniu aż trzech detektorów podczerwieni w jednej czujce. Gwarantuje to niespotykaną czułość i pozwala wychwycić nawet minimalny ruch. Kanlux SENTO, ze względu na nietypowe cechy, określamy jako czujniki obecności. Dodatkową zaletą jest uniwersalny montaż - podtynkowy i natynkowy.

Materiał: tworzywo sztuczne

Kanlux SENTO is an electronic sensor for movement detection. Its exceptionality lies in the fact that as many as three infrared detectors are installed in one sensor. This guarantees an unprecedented sensitivity and allows you to capture even the slightest movement. Kanlux SENTO, due to its unusual. The additional advantage is universal installation - flush-mounted and surface-mounted.

Materiał: plastic

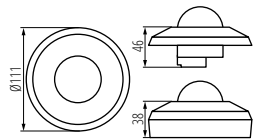
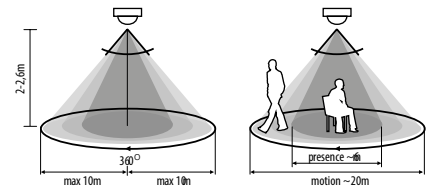

SENTO-O-WT



SENTO-O-WT-W	37366	5905339373663	2000	do nadbudowania na suficie, do wbudowania w sufit ceiling mounted, Recessed mount in the ceiling	H360	10-30	3xPIR
SENTO-O-WT-B	37367	5905339373670	2000	do nadbudowania na suficie, do wbudowania w sufit ceiling mounted, Recessed mount in the ceiling	H360	10-30	3xPIR

[V]	[Hz]	IP							CE	EAC	UK CA	
220-240 AC	50	44/20			max 20	3-2000	-20+40	0,75÷1,5				

Kanlux

SENSQUARE

CZUJNIK RUCHU PIR ► PIR MOTION SENSOR



SENSQUARE-W



SENSQUARE-B

Czujniki SENSQUARE to przystosowane do montażu na ścianie czujniki na podczerwień. Połączenie unikalnego wyglądu, szerokiego pola detekcji oraz stopnia IP54 pozwala dopasować czujnik do wielu aplikacji. Dodatkowym atutem czujnika jest dostępne w zestawie akcesorium pozwalające na montaż czujnika na rogach wewnętrznych i zewnętrznych. Dostępny w kolorze czarnym i białym.

Materiał: tworzywo sztuczne

SENSQUARE sensors are designed for wall mounting and use infrared technology. The combination of a unique design, a wide detection range, and an IP54 rating allows for the adaptation of the sensor to many applications. An additional advantage of the sensor is the included accessory that allows for mounting the sensor on both internal and external corners. Available in black and white..

Materiał: plastic

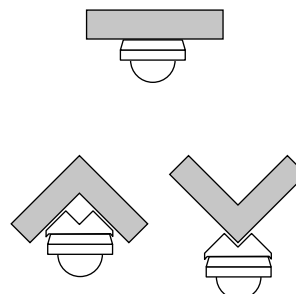
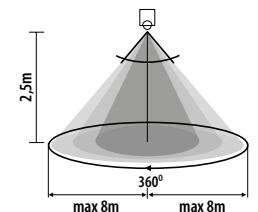

SENSQUARE



SENSQUARE-W	37368	5905339373687	1200	do nadbudowania na ścianie wall mounted	H360	10-15	PIR
SENSQUARE-B	37369	5905339373694	1200	do nadbudowania na ścianie wall mounted	H360	10-15	PIR

[V]	[Hz]	IP							CE	EAC	UK CA	
220-240 AC	50	54			max 8	3-2000	-20+40	0,75÷1,5				

Kanlux MERGE-WT

CZUJNIK RUCHU PIR ► PIR MOTION SENSOR



MERGR-WT-O-W

Kompaktowy czujnik ruchu na podczerwień MERGE-WT. Maksymalny zasięg detekcji to 8 metrów, horyzontalny kąt detekcji wynosi 360 stopni. Możemy ustawić regulacje czasu świecenia jak i poziom natężenia oświetlenia, przy którym czujnik pracuje. Atutem czujnika jest wysoki stopień IP65.

Materiał: tworzywo sztuczne

Compact infrared motion sensor MERGE-WT. The maximum detection range is 8 meters, and the horizontal detection angle is 360 degrees. You can adjust the lighting duration and the light intensity level at which the sensor operates. The sensor's advantage is its high IP65 rating.

Materiał: plastic

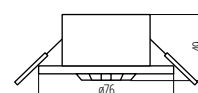
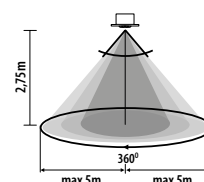

MERGR-WT-O-W

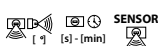

MERGR-WT-O-W | **37370** | 5905339373700 | 1200 | do wbudowania w sufit | Recessed mount in the ceiling | H360 | 10-30 | PIR

[V]	[Hz]	IP	🏠	◻	max 8	3-2000	-20÷40	📦	0,75÷1,5	CE	EAC	UK	CA	⬇️
220-240 AC	50	65\20												

Kanlux SLICK JQ

CZUJNIK RUCHU PIR ► PIR MOTION SENSOR



SLICK JQ-L-W



SLICK JQ-L-B

Kanlux SLICK JQ to czujnik ruchu, którego maksymalny zasięg wykrywania wynosi 12 metrów. Możemy ustawić regulacje czasu świecenia jak i poziom natężenia oświetlenia, przy którym czujnik pracuje.

Materiał: tworzywo sztuczne

Kanlux SLICK JQ is a motion detector whose maximum detection range comes to 12 metres. You can set adjustments of the lighting time and light intensity level at which the detector works.

Materiał: plastic

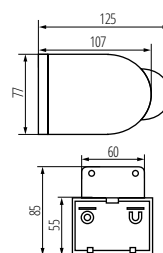
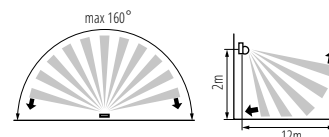

SLICK JQ

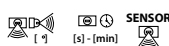

SLICK JQ-L-W | **08390** | 5905339083906 | 1200 | do nadbudowania na ścianie | wall mounted | H160\V20 | 8-10 | PIR
 SLICK JQ-L-B | **08391** | 5905339083913 | 1200 | do nadbudowania na ścianie | wall mounted | H160\V20 | 8-10 | PIR

[V]	[Hz]	IP	🏠	◻	max 12	3-2000	-10÷40	📦	1÷2,5	CE	EAC	UK	CA	⬇️
220-240 AC	50	44												

ALER MINI

CZUJNIK RUCHU PIR ► PIR MOTION SENSOR



ALER MINI-W

Czujnik ALER MINI-W to niewielki czujnik na podczerwień o efektywnym i minimalistycznym wyglądzie. Horyzontalny kąt działania czujnika wynosi 140°, a wertykalny 45°, a dzięki łatwej regulacji mechanicznej (pion 45°, poziom 90°) można dostosować go do swoich potrzeb. Posiada wysoką klasę szczelności (IP44), co sprawia, że czujnik ten można montować w miejscach bezpośrednio narażonych na działanie czynników atmosferycznych.

- Maksymalny zasięg wykrywania ruchu wynoszący 8m
- Maksymalny horyzontalny kąt działania czujnika ruchu wynoszący 140°
- Możliwość regulacji czasu świecenia od 10s do 15min
- Możliwość ustawienia poziomu natężenia oświetlenia otoczenia, przy którym urządzenie pracuje

Materiał: tworzywo sztuczne

ALER MINI-W sensor is a small infrared sensor with attractive and minimalistic design. The horizontal angle of the sensor work comes to 140°, and vertical 45°, and thanks to easy mechanical adjustment (vertical 45°, level 90°) it can be adapted to your needs. Owing to the high class of tightness (IP44), this sensor can be mounted in places directly exposed to weather conditions.

- Maximum movement detection up to 8m
- Maximum horizontal angle of operation of the motion sensor – 140°
- Light on time adjustable from 10s to 15min
- Capability to set the light intensity of the environment in which the device works

Materiał: plastic

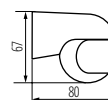
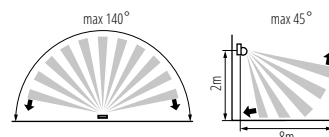

ALER MINI



ALER MINI-W | 23450 | 5905339234506 | 800 | do nadbudowania na ścianie | wall mounted | H140\W45 | 10-15 | PIR

[V] 220-240 AC	[Hz] 50	IP 44			 max 8	 3-2000	 -20+40		 1+2,5	CE	EAC	UK	
-------------------	------------	----------	--	--	-----------	------------	------------	--	-----------	----	-----	----	--

ALER JQ

CZUJNIK RUCHU PIR ► PIR MOTION SENSOR



ALER JQ-30-W



ALER JQ-30-B

Kanlux ALER JQ to czujnik ruchu, którego maksymalny zasięg wykrywania wynosi 12 metrów. Możemy ustawić regulacje czasu świecenia jak i poziom natężenia oświetlenia, przy którym czujnik pracuje.

Materiał: tworzywo sztuczne

Kanlux ALER JQ is a motion detector whose maximum detection range comes to 12 metres. You can set adjustments of the lighting time and light intensity level at which the detector works.

Materiał: plastic

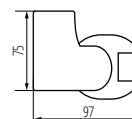
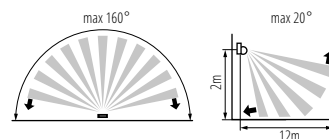

ALER JQ-30



ALER JQ-30-W | 00460 | 5905339004604 | 1200 | do nadbudowania na ścianie | wall mounted | H160\W20 | 8-7 | PIR
 ALER JQ-30-B | 00461 | 5905339004611 | 1200 | do nadbudowania na ścianie | wall mounted | H160\W20 | 8-7 | PIR

[V] 220-240 AC	[Hz] 50	IP 44			 max 12	 3-2000	 -20+40		 1+2,5	CE	EAC	UK	
-------------------	------------	----------	--	--	------------	------------	------------	--	-----------	----	-----	----	--

Kanlux ZONA JQ-37

CZUJNIK RUCHU PIR ► PIR MOTION SENSOR



ZONA JQ-37-B



ZONA JQ-37-W



ZONA JQ-37-B	00463	5905339004635	1200	do nadbudowania na suficie	ceiling mounted	H360°V120	15-7	PIR
ZONA JQ-37-W	00464	5905339004642	1200	do nadbudowania na suficie	ceiling mounted	H360°V120	15-7	PIR

[V] 220-240 AC	[Hz] 50	IP 20			max 10	3-2000	1+2,5				
--------------------------	-------------------	-----------------	--	--	---------------	---------------	--------------	--	--	--	--

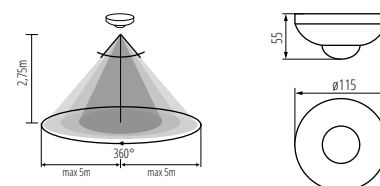

ZONA JQ-37

Kanlux ZONA JQ-37 to czujnik ruchu, którego maksymalny zasięg wykrywania wynosi 10 metrów. Możemy ustawić regulację czasu świecenia jak i poziom natężenia oświetlenia, przy którym czujnik pracuje. Dostępny jest w białej i czarnej wersji kolorystycznej.

Maksymalny zasięg wykrywania ruchu wynoszący 10m

Maksymalny horyzontalny kąt działania czujnika ruchu wynoszący 360°

Maksymalny wertykalny kąt działania czujnika ruchu wynoszący 120°

Możliwość regulacji czasu świecenia od 15s do 7min

Możliwość ustawienia poziomu natężenia oświetlenia otoczenia, przy którym urządzenie pracuje

Materiał: tworzywo sztuczne

Kanlux ZONA JQ-37 is a motion sensor whose maximum detection range is 10 meters. We can adjust the lighting time and the light intensity level at which the sensor works. It is available in white and black colors.

Maximum movement detection up to 10m

Maximum horizontal angle of operation of the motion sensor – 360°

Maximum vertical angle of operation of the motion sensor 120°

Light on time adjustable from 15s to 7min

Capability to set the light intensity of the environment in which the device works

Material: plastic

Kanlux ZONA

CZUJNIK RUCHU PIR ► PIR MOTION SENSOR



ZONA FLAT-W



ZONA FLAT-W	23452	5905339234520	2000	do nadbudowania na suficie	ceiling mounted	H360°V120	10-15	PIR
-------------	--------------	---------------	------	----------------------------	-----------------	-----------	-------	-----

[V] 220-240 AC	[Hz] 50	IP 20			max 8	3-2000	5+25	0,75+1,5				
--------------------------	-------------------	-----------------	--	--	--------------	---------------	-------------	-----------------	--	--	--	--

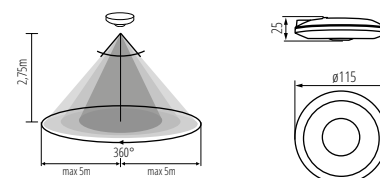

ZONA FLAT

Kanlux ZONA FLAT to czujnik ruchu o maksymalnym zasięgu wykrywania ruchu 8m. Jego z kolei maksymalny horyzontalny kąt działania to 360 stopni. W czujniku ZONA masz możliwość regulowania czasu świecenia od 10s do 15min a także ustawienia poziomu natężenia oświetlenia otoczenia przy którym urządzenie będzie pracowało.

Maksymalny zasięg wykrywania ruchu wynoszący 8m

Maksymalny horyzontalny kąt działania czujnika ruchu wynoszący 360°

Możliwość regulacji czasu świecenia od 10s do 15min

Możliwość ustawienia poziomu natężenia oświetlenia otoczenia, przy którym urządzenie pracuje

Wykrywanie ruchu 0.6-1.5m/s

Maksymalny wertykalny kąt działania czujnika ruchu wynoszący 120°

Materiał: tworzywo sztuczne

Kanlux ZONA FLAT is a motion detector with maximum motion detection range of 8m. In turn, its maximum horizontal angle of work comes to 360 degrees. In the ZONA sensor, you can adjust the time of lighting from 10s to 15min as well as set the surrounding light intensity level at which the device will work.

Maximum movement detection up to 8m

Maximum horizontal angle of operation of the motion sensor – 360°

Light on time adjustable from 10s to 15min

Capability to set the light intensity of the environment in which the device works

Motion detection 0.6...1.5m/s

Maximum vertical angle of operation of the motion sensor 120°

Material: plastic

Kanlux

MERGE JQ

CZUJNIK RUCHU PIR ► PIR MOTION SENSOR



MERGE JQ-L

Kanlux MERGE JQ-L to czujnik ruchu, którego maksymalny zasięg wykrywania wynosi 9 metrów. Horyzontalny kąt działania czujnika wynosi 150 stopni. Możemy ustawić regulację czasu świecenia jak i poziom natężenia oświetlenia, przy którym czujnik pracuje.

- Maksymalny zasięg wykrywania ruchu wynoszący 9m
- Maksymalny horyzontalny kąt działania czujnika wynoszący 150°
- Maksymalny wertykalny kąt działania czujnika wynoszący 60°
- Możliwość regulacji czasu świecenia od 10s do 7min
- Możliwość ustawienia poziomu natężenia oświetlenia otoczenia, przy którym urządzenie pracuje
- Obciążenie rezystancyjne wynoszące max 1200W, obciążenie impedancyjne wynoszące max 400W
- Materiał: tworzywo sztuczne

Kanlux MERGE JQ is a motion detector whose maximum detection range comes to 9 metres. The horizontal angle of the detector work comes to 150 degrees. You can set adjustments of the lighting time and light intensity level at which the detector works.

- Maximum movement detection up to 9m
- Maximum horizontal angle of operation of the motion sensor – 150°
- Maximum vertical angle of operation of the motion sensor – 60°
- Light on time adjustable from 10s to 7min
- Capability to set the light intensity of the environment in which the device works
- Max 1200W resistive load, max. 400W inductive load
- Materiał: plastik

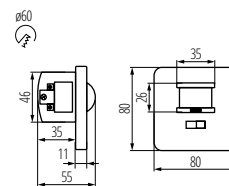
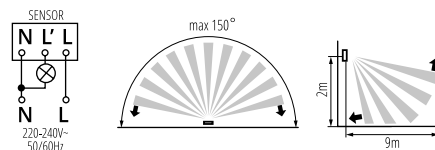

MERGE JQ-L



MERGE JQ-L | 07690 | 5905339076908 | 1200 do wbudowania w ścianę | Recessed mount in the wall | H150/V60 | 10-7 | PIR

[V] 220-240 AC	[Hz] 50	IP 20			 max 9	 3-2000	 5+25	 1+2,5	CE	ERAC	UK CA	
-------------------	------------	----------	--	--	-----------	------------	----------	-----------	----	------	----------	--

Kanlux

MARID JQ

CZUJNIK RUCHU PIR ► PIR MOTION SENSOR



MARID JQ-L

Kanlux MARID JQ to czujnik ruchu, którego maksymalny zasięg wykrywania wynosi 12 metrów. Możemy ustawić regulacje czasu świecenia jak i poziom natężenia oświetlenia, przy którym czujnik pracuje. Czujnik można uruchamiać również sygnałem dźwiękowym.

- Maksymalny zasięg wykrywania ruchu wynoszący 12m
- Maksymalny horyzontalny kąt działania czujnika wynoszący 150°
- Maksymalny wertykalny kąt działania czujnika wynoszący 30°
- Możliwość regulacji czasu świecenia od 10s do 7min
- Możliwość ustawienia poziomu natężenia oświetlenia otoczenia, przy którym urządzenie pracuje
- Wykrywanie ruchu 0.3...3m/s (1...10km/h)
- Regulacja czułości w zakresie 3...1000lx
- Możliwość uruchamiania czujnika sygnałem dźwiękowym w zakresie 30-90dB
- Przeznaczony jest tylko do odbiorników o charakterze rezystancyjnym
- Materiał: tworzywo sztuczne

Kanlux MARID JQ is a motion detector whose maximum detection range comes to 12 metres. You can set adjustments of the lighting time and light intensity level at which the detector works. The detector can be activated by means of sound signal too.

- Maximum movement detection up to 12m
- Maximum horizontal angle of operation of the motion sensor – 150°
- Maximum vertical angle of operation of the motion sensor – 30°
- Light on time adjustable from 10s to 7min
- Capability to set the light intensity of the environment in which the device works
- Motion detection 0.3...3m/s (1...10km/h)
- Sensitivity adjustment in the range of 3...1000lx
- Capability to activate the sensor with a 30-90db sound signal
- Designed only for resistive loads
- Materiał: plastik

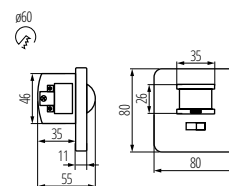
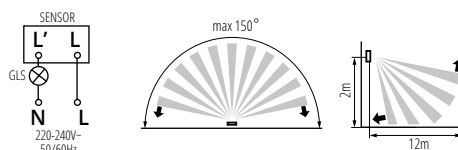

MARID JQ-L

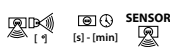

MARID JQ-L | 08910 | 5905339089106 | 40-500 do wbudowania w ścianę | Recessed mount in the wall | H150/V30 | 10-7 | PIR

[V] 220-240 AC	[Hz] 50	IP 20			 max 12	 3-2000	 5+25	 0,75+2,5	CE	ERAC	UK CA	
-------------------	------------	----------	--	--	------------	------------	----------	--------------	----	------	----------	--

Kanlux

ROLF JQ

CZUJNIK RUCHU MW ► MW MOTION SENSOR



ROLF JQ-L

Kanlux ROLF JQ to mikrofalowy czujnik ruchu. Horizontalny kąt działania czujnika wynosi 360 stopni. Możemy ustawić regulacje czasu świecenia, jak i poziom natężenia oświetlenia, przy którym czujnik pracuje.

- maksymalny zasięg wykrywania ruchu wynoszący 8m
- maksymalny horizontalny kąt działania czujnika ruchu wynoszący 360°
- maksymalny wertykalny kąt działania czujnika ruchu wynoszący 160°
- możliwość regulacji czasu świecenia od 5s do 12min
- możliwość ustawienia poziomu natężenia oświetlenia otoczenia, przy którym urządzenie pracuje
- regulacja czułości w zakresie 2...2000lx
- wykrywanie ruchu 0.3...3m/s (1...10km/h)

Materiał: tworzywo sztuczne

Kanlux ROLF JQ is a motion detector. The horizontal angle of the detector work comes to 360 degrees. You can set adjustments of the lighting time and light intensity level at which the detector works.

- Maximum movement detection up to 8m
- Maximum horizontal angle of operation of the motion sensor – 360°
- Maximum vertical angle of operation of the motion sensor – 160°
- Light on time adjustable from 5s to 12min
- Capability to set the light intensity of the environment in which the device works
- Sensitivity adjustment in the range of 2...2000lx
- Motion detection 0.3...3m/s (1...10km/h)

Material: plastic

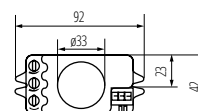
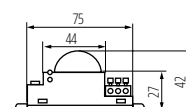
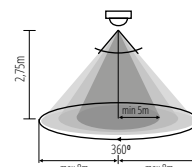

ROLF JQ-L



ROLF JQ-L	08820	5905339088208	1200	do nadbudowania na ścianie, do nadbudowania na suficie, do nadbudowania na podłożu wall mounted, ceiling mounted, surface mounted	H360V160	5-12	mikrofalowy microwave
-----------	-------	---------------	------	---	----------	------	-------------------------

[V]	[Hz]	IP	House	max 8	2-2000	5+25	1+2,5	CE	EAC	UKA	Down Arrow
220-240 AC	50	20									

Kanlux

ROLF JQ

CZUJNIK RUCHU MW ► MW MOTION SENSOR



ROLF MINI JQ-L

Kanlux ROLF JQ to mikrofalowy czujnik ruchu. Horizontalny kąt działania czujnika wynosi 360 stopni. Możemy ustawić regulacje czasu świecenia, jak i poziom natężenia oświetlenia, przy którym czujnik pracuje.

- maksymalny zasięg wykrywania ruchu wynoszący 10m
- maksymalny horizontalny kąt działania czujnika ruchu wynoszący 360°
- maksymalny wertykalny kąt działania czujnika ruchu wynoszący 140°
- możliwość regulacji czasu świecenia od 10s do 30min
- możliwość ustawienia poziomu natężenia oświetlenia otoczenia, przy którym urządzenie pracuje
- regulacja czułości w zakresie 2...2000lx
- wykrywanie ruchu 0.3...3m/s (1...10km/h)

Materiał: tworzywo sztuczne

Kanlux ROLF JQ is a motion detector. The horizontal angle of the detector work comes to 360 degrees. You can set adjustments of the lighting time and light intensity level at which the detector works.

- Maximum movement detection up to 10m
- Maximum horizontal angle of operation of the motion sensor – 360°
- Maximum vertical angle of operation of the motion sensor – 140°
- Light on time adjustable from 10s to 30min
- Capability to set the light intensity of the environment in which the device works
- Sensitivity adjustment in the range of 2...2000lx
- Motion detection 0.3...3m/s (1...10km/h)

Material: plastic

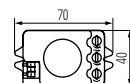
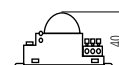
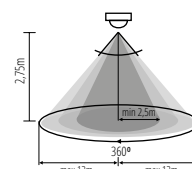

ROLF MINI JQ-L



ROLF MINI JQ-L	08822	5905339088222	1200	do nadbudowania na ścianie, do nadbudowania na suficie, do nadbudowania na podłożu wall mounted, ceiling mounted, surface mounted	H360V140	10-30	mikrofalowy microwave
----------------	-------	---------------	------	---	----------	-------	-------------------------

[V]	[Hz]	IP	House	max 10	2-2000	5+25	1+2,5	CE	EAC	UKA	Down Arrow
220-240 AC	50	20									

Kanlux

MERGE JQ

CZUJNIK RUCHU PIR ► PIR MOTION SENSOR



MERGE JQ-O

Kanlux MERGE JQ-O to czujnik ruchu, którego maksymalny zasięg wykrywania wynosi 5 metrów. Horyzontalny kąt działania czujnika wynosi 360 stopni. Możemy ustawić regulację czasu świecenia jak i poziom natężenia oświetlenia, przy którym czujnik pracuje.

- maksymalny zasięg wykrywania ruchu wynoszący 5m
- maksymalny horyzontalny kąt działania czujnika wynoszący 360°
- maksymalny wertykalny kąt działania czujnika wynoszący 120°
- możliwość regulacji czasu świecenia od 5s do 6min
- możliwość ustawienia poziomu natężenia oświetlenia otoczenia, przy którym urządzenie pracuje
- obciążenie rezystancyjne wynoszące max 2000W, obciążenie indukcyjne wynoszące max 800W
- Materiał: tworzywo sztuczne

Kanlux MERGE JQ is a motion detector whose maximum detection range comes to 5 metres. The horizontal angle of the detector work comes to 360 degrees. You can set adjustments of the lighting time and light intensity level at which the detector works.

- Maximum movement detection up to 5m
- Maximum horizontal angle of operation of the motion sensor – 360°
- Maximum vertical angle of operation of the motion sensor – 120°
- Light on time adjustable from 5s to 6min
- Capability to set the light intensity of the environment in which the device works
- Max 2000W resistive load, max. 800W inductive load
- Materiał: plastik

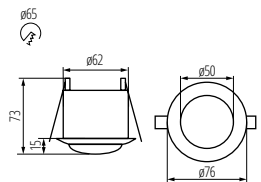
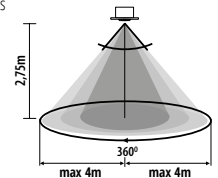

MERGE JQ-O



MERGE JQ-O | 07691 | 5905339076915 | 2000 | do wbudowania w sufit | Recessed mount in the ceiling | H360V120 | 5-6 | PIR

[V]	[Hz]	IP							CE	ERC	UKA	
220-240 AC	50	20			max 5	3-2000	5+25					

Kanlux

ROLF JQ

CZUJNIK RUCHU MW ► MW MOTION SENSOR



ROLF JQ-O

Kanlux ROLF JQ to mikrofalowy czujnik ruchu. Horyzontalny kąt działania czujnika wynosi 360 stopni. Możemy ustawić regulację czasu świecenia, jak i poziom natężenia oświetlenia, przy którym czujnik pracuje.

- maksymalny zasięg wykrywania ruchu wynoszący 9m
- maksymalny horyzontalny kąt działania czujnika wynoszący 360°
- maksymalny wertykalny kąt działania czujnika wynoszący 160°
- możliwość regulacji czasu świecenia od 6s do 12min
- możliwość ustawienia poziomu natężenia oświetlenia otoczenia, przy którym urządzenie pracuje
- regulacja czułości w zakresie 2...2000lx
- wykrywanie ruchu 0.3...3m/s (1...10km/h)
- Materiał: tworzywo sztuczne

Kanlux ROLF JQ is a motion detector. The horizontal angle of the detector work comes to 360 degrees. You can set adjustments of the lighting time and light intensity level at which the detector works.

- Maximum movement detection up to 9m
- Maximum horizontal angle of operation of the motion sensor – 360°
- Maximum vertical angle of operation of the motion sensor – 160°
- Light on time adjustable from 6s to 12min
- Capability to set the light intensity of the environment in which the device works
- Sensitivity adjustment in the range of 2...2000lx
- Motion detection 0.3...3m/s (1...10km/h)
- Materiał: plastik

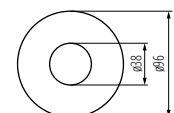
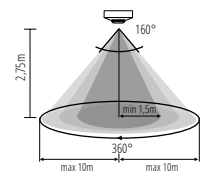

ROLF JQ-O



ROLF JQ-O | 08821 | 5905339088215 | 1200 | do nadbudowania na sufcie | ceiling mounted | H360V160 | 6-12 | mikrofalowy | microwave

[V]	[Hz]	IP								CE	ERC	UKA	
220-240 AC	50	20			max 9	2-2000	5+25		0,75+1,5				

Kanlux MERGE

CZUJNIK RUCHU PIR ► PIR MOTION SENSOR



MERGE ADJ-O



Kanlux MERGE ADJ to czujnik ruchu PIR o maksymalnym zasięgu wykrywania ruchu 5m. Jego maksymalny horyzontalny kąt działania to 360 stopni. W czujniku MERGE ADJ masz możliwość regulacji ustawienia parametrów bez konieczności demontażu czujnika.

- maksymalny zasięg wykrywania ruchu wynoszący 5m
- maksymalny horyzontalny kąt działania czujnika ruchu wynoszący 360°
- możliwość regulacji czasu świecenia od 10s do 15min
- możliwość ustawienia poziomu natężenia oświetlenia otoczenia, przy którym urządzenie pracuje wykrywanie ruchu 0.6-1.5m/s
- maksymalny wertykalny kąt działania czujnika ruchu wynoszący 120°
- Materiał: tworzywo sztuczne

Kanlux MERGE ADJ is a PIR motion detector with maximum motion detection range of 5m. Its maximum horizontal angle of work comes to 360 degrees. In the MERGE ADJ sensor, you can adjust settings of parameters without a necessity to disassemble the detector.

- Maximum movement detection up to 5m
- Maximum horizontal angle of operation of the motion sensor – 360°
- Light on time adjustable from 10s to 15min
- Capability to set the light intensity of the environment in which the device works
- Motion detection 0.6...1.5m/s
- Maximum vertical angle of operation of the motion sensor 120°
- Material: plastic

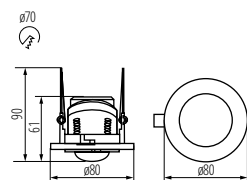
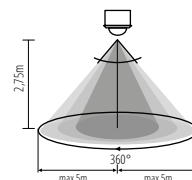

MERGE ADJ-O



MERGE ADJ-O | 23451 | 5905339234513 | 800 do wbudowania w sufit | Recessed mount in the ceiling | H360V120 | 10-15 | PIR

[V]	[Hz]	IP	max 5	3-2000	5+25	0,75+1,5	CE	EAC	UK	CA	↓
220-240 AC	50	20									

Kanlux MERGE

CZUJNIK RUCHU MW ► MW MOTION SENSOR



MERGE MW-L



Czujnik Kanlux MERGE MW to estetyczne i funkcjonalne rozwiązanie. Maksymalny zasięg wykrywania wynosi 9 metrów. Możemy ustawić regulacje czasu świecenia jak i poziom natężenia oświetlenia, przy którym czujnik pracuje.

- maksymalny zasięg wykrywania ruchu wynoszący 9m
- maksymalny horyzontalny kąt działania czujnika ruchu wynoszący 180°
- możliwość regulacji czasu świecenia od 10s do 12min
- możliwość ustawienia poziomu natężenia oświetlenia otoczenia, przy którym urządzenie pracuje wykrywanie ruchu 0.6-1.5m/s
- maksymalny wertykalny kąt działania czujnika ruchu wynoszący 180°
- Materiał: tworzywo sztuczne

Kanlux MERGE MW detector is an aesthetic and functional solution. The maximum detection range comes to 9 metres. You can set adjustments of the lighting time and light intensity level at which the detector works.

- Maximum movement detection up to 9m
- Maximum horizontal angle of operation of the motion sensor – 180°
- Light on time adjustable from 10s to 12min
- Capability to set the light intensity of the environment in which the device works
- Motion detection 0.6...1.5m/s
- Maximum vertical angle of operation of the motion sensor 180°
- Material: plastic

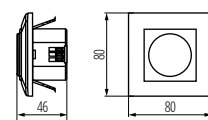
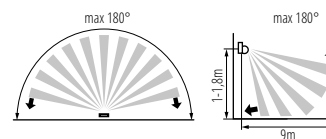

MERGE MW-L



MERGE MW-L | 23453 | 5905339234537 | 1200 do wbudowania w ścianę | Recessed mount in the wall | 180 | 10-12 | mikrofalowy | microwave

[V]	[Hz]	IP	max 9	3-2000	5+25	0,75+1,5	CE	EAC	UK	CA	↓
220-240 AC	50	20									

Kanlux SENTO

CZUJNIK RUCHU PIR ► PIR MOTION SENSOR



SENTO



Kanlux SENTO to czujnik elektroniczny służący do wykrywania ruchu. Jego wyjątkowość polega na zabudowaniu aż trzech detektorów podczerwieni w jednej czujce. Gwarantuje to niespotykaną czułość i pozwala wychwycić nawet minimalny ruch. Kanlux SENTO, ze względu na nietypowe cechy, określamy jako czujniki obecności.

Materiał: tworzywo sztuczne

Kanlux SENTO is an electronic sensor for movement detection. Its exceptionality lies in the fact that as many as three infrared detectors are installed in one sensor. This guarantees an unprecedented sensitivity and allows you to capture even the slightest movement. Kanlux SENTO, due to its unusual features, is referred to as a presence detector.

Material: plastic

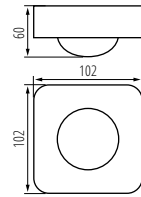
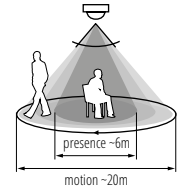
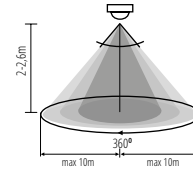

SENTO



SENTO 26820 5905339268204 2000 do nadbudowania na ścianie, do nadbudowania na suficie | wall mounted, ceiling mounted H360/V120 10-30 3xPIR

[V] 220-240 AC	[Hz] 50	IP 20	max 10	3-2000	5+25	0,75+1,5	CE	ERC	UK	↓
-------------------	------------	----------	--------	--------	------	----------	----	-----	----	---

Kanlux SENZO

CZUJNIK RUCHU PIR ► PIR MOTION SENSOR



SENZO



Kanlux SENZO to czujnik ruchu PIR stosowany w systemach automatycznego załączania oświetlenia. Specjalne rozmieszczenie dwóch czujników podczerwieni w Kanlux SENZO pozwala na zastosowanie go w instalacjach wysokich pomieszczeń, takich jak hale magazynowe czy produkcyjne. Jego zasięg wertykalny to aż 10 metrów.

Materiał: tworzywo sztuczne

Kanlux SENZO is a PIR movement sensor used in automatic lighting switching systems. The special arrangement of two infrared sensors in Kanlux SENZO allows it to be used in high room installations, such as warehouses or production halls. Its vertical range is as much as 10 meters.

Material: plastic

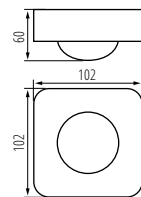
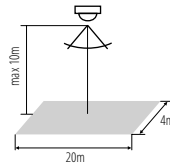

SENZO



SENZO 26821 5905339268211 2000 do nadbudowania na ścianie, do nadbudowania na suficie | wall mounted, ceiling mounted H360/V120 10-30 2xPIR

[V] 220-240 AC	[Hz] 50	IP 20	max 10	3-2000	5+25	0,75+1,5	CE	ERC	UK	↓
-------------------	------------	----------	--------	--------	------	----------	----	-----	----	---



Kanlux AZ-10A

PRZEKAŹNIK ZMIERZCHOWY ► TWILIGHT SWITCH



AZ-10A



AZ-10A | 22371 | 5905339223715 | biały | white | do nadbudowania na ścianie | wall mounted

[V] 220-240 AC	[Hz] 50	In[A] 10	(VA) 2300	⊕ [°C] -20+40	□	⌚	IP 20/65	CE	EAC	UKA	⌚
-------------------	------------	-------------	--------------	------------------	---	---	-------------	----	-----	-----	---

Kanlux AZ-10A to automat zmierzchowy. Służy do włączania i wyłączania obwodów oświetlenia lub innych odbiorników elektrycznych, w zależności od poziomu natężenia oświetlenia naturalnego (dzień/noc).

Histeresa -20Lx

Kanlux AZ-10 is a dusk and dawn light switch system. It is used for turning on and turning off lighting circuits or other electric receivers, depending on the natural light intensity level (day/night).

Hysteresis -20Lx

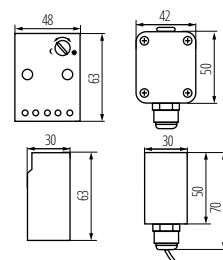

AZ-10A

Kanlux CYBER

ZEGAR/PROGRAMATOR STERUJĄCY ► CONTROL TIMER / PROGRAMMER



CYBER TM-6



CYBER TM-6 | 01016 | 5905339010162 | 3600 | 10

[V]	[Hz]	In[A]	IP	⏚	⊕	CE	ERC	UK	⚡
220-240 AC	50	16(2)	20						

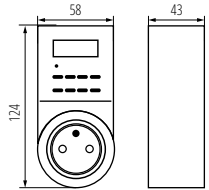

CYBER TM-6

Kanlux CYBER to adapter gniazda wtyczkowego z dobowym programatorem cyfrowym. Umożliwia zaprogramowanie włączania i wyłączenia podłączonych urządzeń w określonym czasie.

wyposażony w układ podtrzymujący pamięć
możliwość zaprogramowania max 10 włączeń/wyłączeń
programator pracuje w trybach dobowym i tygodniowym

Kanlux CYBER is an adapter of an extension socket with a 24-hour digital programmer. It makes it possible to programme turning on and turning off operations for connected devices at pre-set time.

Equipped with a memory keeping system
Up to 10 programmable on/off operations
The timer works in 24h and weekly mode

Kanlux STER TS-MF

ZEGAR/PROGRAMATOR STERUJĄCY ► CONTROL TIMER / PROGRAMMER



STER TS-MF-1



STER TS-MF1 | 01001 | 5905339010018 | 3500 | 1

[V]	[Hz]	In[A]	IP	⏚	⊕	CE	ERC	UK	⚡
220-240 AC	50	16(2)	20						

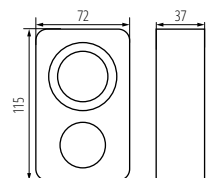

STER TS-MF-1

Kanlux STER TS-MF to adapter gniazda wtyczkowego z dobowym programatorem mechanicznym. Umożliwia zaprogramowanie włączania i wyłączenia podłączonych urządzeń w określonym czasie.

programator pracuje w trybie dobowym
minimalny czas włączenia/wyłączenia wynoszący 15min
programator posiada funkcję stałego załączenia obciążenia

Kanlux STER TS-MF is an adapter of an extension socket with a 24-hour mechanical programmer. It makes it possible to programme turning on and turning off operations for connected devices at pre-set time.

The timer works in 24h mode
Minimum on/off time 15min
Timer has constant load switching capability

Kanlux ADI

ZASILACZ CC ► CC POWER SUPPLY UNIT



ADI 350 1X3W

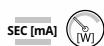

ADI 350 1x3W | 01440 | 5905339014405 | 350 | 1-3

[V] 220-240 AC	[Hz] 50	CC	PRI [V] 220-240	SEC [V] 0,5-10 DC	F	IP 20	House icon	□
Wiring icon	[mm] 0,75	[m] 0,1	Temperature icon 5+25	CE	ERC	UK CA	Recycling icon	

Zasilacz elektroniczny Kanlux ADI - o maksymalnej dopuszczalnej temperaturze obudowy 75°C i stabilizacji prądu 350mA DC - posiada wbudowane zabezpieczenie przeciwzwarciowe i przeciwprzeciążeniowe oraz zabezpieczenie termiczne wyłączające zasilacz po przekroczeniu temperatury 110°C.

ADI 350 1-3W stabilizacja prądu 350mA DC

maksymalna dopuszczalna temperatura obudowy wynosząca 75°C

zabezpieczenie termiczne wyłączające zasilacz po przekroczeniu temperatury 110°C

wbudowane zabezpieczenie przeciwzwarciowe i przeciwprzeciążeniowe

Zasilacz nie jest przystosowany do pracy bez obciążenia.

Materiał: tworzywo sztuczne

Kanlux ADI electronic power supply unit - with maximum permissible temperature of casing 75°C and current stabilization 350mA DC - has an embedded protection against short circuits and against overload as well as a thermal protection turning off the power supply unit when the temperature of 110°C is exceeded.

ADI 350 1-3W current stabilization 350mA DC

Maximum permissible housing temperature 75°C

Thermal protection shutting down the power supply after the temperature exceeds 110°C

Built-in circuit and overload protection

The power supply unit is not designed to work without load.

Material: plastic

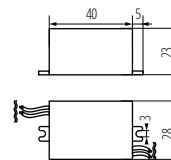

ADI 350 1X3W

Kanlux POWELED

ZASILACZ CV ► CV POWER SUPPLY UNIT



POWELED P 12V 30W

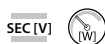

POWELED P 12V 30W	26810	5905339268105	12 DC	1-30
POWELED P 12V 60W	26811	5905339268112	12 DC	1-60
POWELED P 24V 30W	26815	5905339268150	24 DC	1-30
POWELED P 24V 60W	26816	5905339268167	24 DC	1-60
POWELED P 12V 100W	28961	5905339289612	12 DC	1-100
POWELED P 24V 100W	28962	5905339289629	24 DC	1-100
POWELED P 12V 150W	28963	5905339289636	12 DC	75-150
POWELED P 24V 150W	28964	5905339289643	24 DC	75-150
POWELED P 12V 200W	28965	5905339289650	12 DC	120-200
POWELED P 24V 200W	28966	5905339289667	24 DC	120-200

[V] 220-240 AC	[Hz] 50	CV	PRI [V] 220-240	F	IP 20	House icon	□
Wiring icon	[mm] 0,5-1,5	[m] 5+25	Temperature icon 5+25	CE	ERC	UK CA	Recycling icon

Kanlux POWELED to elektroniczny zasilacz stałonapięciowy. Służy do zasilania taśm LED takich jak LEDS P lub LEDS B.

Zasilacz nie jest przystosowany do pracy bez obciążenia.

Materiał: tworzywo sztuczne

Kanlux POWELED is an electronic constant-voltage power supply unit. It is used for powering LED belts such as LEDS P or LEDS B.

The power supply unit is not designed to work without load.

Material: plastic

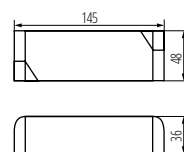

POWELED P 30W

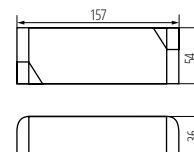

POWELED P 60W

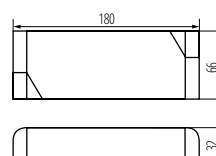

POWELED P 100W

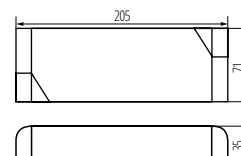

POWELED P 150W / POWELED P 200W

Kanlux CIRCO

ZASILACZ CV ► CV POWER SUPPLY UNIT



CIRCO LED 12VDC



CIRCO LED 12VDC 0-10W	24240	5905339242402	12 DC	0-10
CIRCO LED 12VDC 0-15W	24241	5905339242419	12 DC	0-15

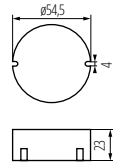

CIRCO LED 12VDC

Kanlux DRIVE LED

ZASILACZ CV ► CV POWER SUPPLY UNIT



DRIVE LED N 15W 12V



DRIVE LED N 15W 12V	23861	5905339238610	220-240 AC	max 15
---------------------	--------------	---------------	------------	--------

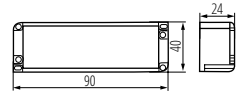

DRIVE LED N 15W 12V

Kanlux SET

TRANSFORMATOR ELEKTRONICZNY SET ► SET ELECTRONIC TRANSFORMER



SET60-K

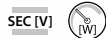

SET60-K	01425	5905339014252	11,5 AC	20-60
SET105-K	01426	5905339014269	11,5 AC	35-105

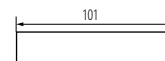

SET60-K

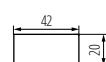
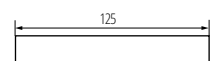

SET105-K

Kanlux CIRCO to zasilacz elektroniczny stałonapięciowy o mocy 10 lub 15 W. Służy do zasilania pasków LED takich jak LEDS P czy LEDS B.

Zasilacz nie jest przystosowany do pracy bez obciążenia.

Zasilacz przeznaczony do wbudowania w oprawy oświetleniowe lub puszkę instalacyjną.

Kanlux CIRCO is an electronic constant-voltage power supply unit with power of 10 or 15 W. It is used for powering LED belts such as LEDS P or LEDS B.

The power supply unit is not designed to work without load.

Zasilacz nie jest przystosowany do pracy bez obciążenia.

Materiał: tworzywo sztuczne

The power supply unit is not designed to work without load.

Materiał: plastic

wyrob przeznaczony do zasilania niskonapięciowych żarówek halogenowych (12V)

współczynnik mocy biernej $\cos\phi$ dla SET60-K i SET105-K wynoszący 0,99, dla SET80LT, SET150-N i SET210-N wynoszący 0,97

maksymalna dopuszczalna temperatura obudowy dla SET60-K wynosząca 80°C, dla pozostałych modeli wynosząca 85°C

zabezpieczenie termiczne wyłączające model SET80LT po przekroczeniu temperatury 100°C, modele SET150-N i SET210-N po przekroczeniu temperatury 110°C, modele SET60-K i SET105-K po przekroczeniu temperatury 120°C

wbudowane zabezpieczenie przeciwzwarciowe i przeciwprzeciążeniowe

Zasilacz nie jest przystosowany do pracy bez obciążenia.

product designed for feeding low voltage halogen light bulbs (12V)

Reactive power factor $\cos\phi$ 0.99 for SET60-K i SET105-K, for SET80LT, SET150-N and SET210-N – 0.97

Maximum permissible housing temperature 80°C for SET60-K, for other models – 85°C

Thermal protection shutting down SET80LT after the temperature exceeds 100°C, for SET150-N and SET210-N – after exceeding 110°C, for SET60-K and SET105-K – after exceeding 120°C

Built-in circuit and overload protection

The power supply unit is not designed to work without load.

Kanlux WIR ZL

WENTYLATOR KANAŁOWY ► DUCTED FAN



WIR ZL100



WIR ZL120



WIR ZL100	70961	8594056490349	biały white
WIR ZL120	70962	8594056490356	biały white

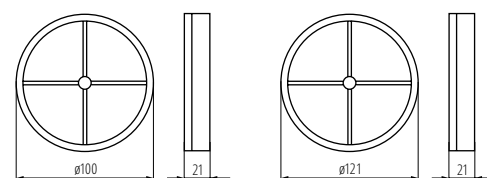

WIR ZL100

WIR ZL120

Kanlux TWISTER

WENTYLATOR KANAŁOWY ► DUCTED FAN



TWISTER AOL100B

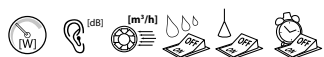

TWISTER AOL100B	70926	8594056490172	19	42	100	
TWISTER AOL100T	70953	8594056490202	19	42	100	tak yes
TWISTER AOL120B	70956	8594056490226	20	42	150	
TWISTER AOL120T	70960	8594056490257	20	42	150	tak yes

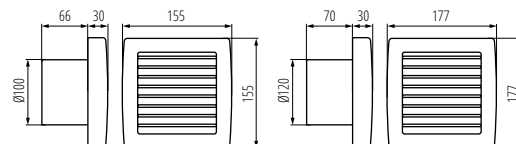

TWISTER AOL100

TWISTER AOL120

[V]	[Hz]	IP	House icon	Square icon	Arrow icon	2550 rpm	1 mm	CE	EMC	UK CA	Recycling icon
220-240 AC	50	X4									

Przepustnice samoczynne z serii Kanlux WIR ZL dostępne są w dwóch rozmiarach 100 oraz 120mm. Wykonane z tworzywa sztucznego, w kolorze białym.

Automatic dampers from Kanlux WIR ZL series are available in two sizes: 100 and 120mm. They are made of plastic, in white colour.

Seria wentylatorów Kanlux TWISTER AOL dostępna jest w dwóch rozmiarach średnicy 100 i 120 mm. Wykonane są z tworzywa sztucznego, w kolorze białym. Ich moc to odpowiednio 19 i 20 W. Ilość obrotów z każdego rozmiaru wynosi 2550/min.

Kanlux TWISTER AOL series of fans is available in two sizes with diameter of 100 and 120 mm. They are made of plastic, in white colour. Their power is 19 and 20 W respectively. The number of rotations from each size comes to 2550/min.



CYKLON EOL100



CYKLON EOL120



CYKLON EOL150

Seria wentylatorów Kanlux CYKLON EOL dostępna jest w trzech rozmiarach średnicy 100, 120 oraz 150mm. Wykonane są z tworzywa sztucznego, w kolorze białym. Ich moc to odpowiednio 19, 20 oraz 22W. Ilość obrotów z każdego rozmiaru wynosi 2550/min.

ilość obrotów wynosząca 2550/min

Kanlux CYKLON EOL series of fans is available in three sizes with diameter of 100, 120 and 150mm. They are made of plastic, in white colour. Their power is 19, 20 and 22W respectively. The number of rotations from each size comes to 2550/min.

Rotation speed: 2550/min

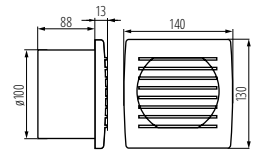

CYKLON EOL100

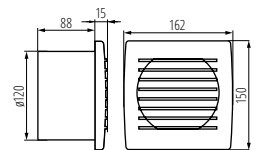

CYKLON EOL120

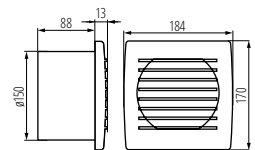

CYKLON EOL150



CYKLON EOL100	70910	8594056490011	19	38	100	tak yes	przewód zakończony wtyczką Cable terminated with a plug	
CYKLON EOL100B	70911	8594056490028	19	38	100		kostka przyłączeniowa Terminal block	
CYKLON EOL120	70915	8594056490066	20	38	150	tak yes	przewód zakończony wtyczką Cable terminated with a plug	
CYKLON EOL120B	70916	8594056490073	20	38	150		kostka przyłączeniowa Terminal block	
CYKLON EOL150	70920	8594056490110	22	38	200	tak yes	przewód zakończony wtyczką Cable terminated with a plug	
CYKLON EOL150B	70921	8594056490127	22	38	200		kostka przyłączeniowa Terminal block	
CYKLON EOL100HT	70936	8594056490035	19	38	100	tak yes	tak yes	kostka przyłączeniowa Terminal block
CYKLON EOL100P	70937	8594056490370	19	38	100	tak yes		kostka przyłączeniowa Terminal block
CYKLON EOL100T	70938	8594056490059	19	38	100		tak yes	kostka przyłączeniowa Terminal block
CYKLON EOL120HT	70941	8594056490080	20	38	150	tak yes	tak yes	kostka przyłączeniowa Terminal block
CYKLON EOL120P	70942	8594056490387	20	38	150	tak yes		kostka przyłączeniowa Terminal block
CYKLON EOL120T	70943	8594056490103	20	38	150		tak yes	kostka przyłączeniowa Terminal block
CYKLON EOL150P	70947	8594056490394	22	38	200	tak yes		kostka przyłączeniowa Terminal block
CYKLON EOL150T	70948	8594056490158	22	38	200		tak yes	kostka przyłączeniowa Terminal block



Kanlux GRIP

ROZGAŁĘŻNIKI, GNIAZDA, WTYCZKI ► SPLITTERS, SOCKETS, PLUGS



GRIP GP/S

GRIP W/US



GRIP GP/S	04862	5905339048622	czarny black
GRIP W/US	04863	5905339048639	czarny black

[V] 250 AC	[Hz] 50		In[A] 16	IP 44			
----------------------	-------------------	--	--------------------	-----------------	--	--	--

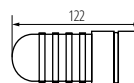

GRIP GP/S

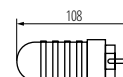

GRIP W/US

gniazdo wtyczkowe do przedłużaczy.
STAN GP posiada I klasę ochronności przed porażeniem elektrycznym
GRIP GP/S wyposażony w uziemienie typu Schuko
Materiał: tworzywo sztuczne
extension socket for cable cords.
STAN GP has I Class protection against electric shock
GRIP GP/S equipped with Schuko earthing
Material: plastic

Kanlux PIN W/US

ROZGAŁĘŻNIKI, GNIAZDA, WTYCZKI ► SPLITTERS, SOCKETS, PLUGS



PIN W/US



PIN W/US	02186	5905339021861	biały white
----------	--------------	---------------	---------------

[V] 250 AC	[Hz] 50			In[A] 16	IP 20			
----------------------	-------------------	--	--	--------------------	-----------------	--	--	--

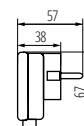

PIN W/US

gniazdo wtyczkowe do przedłużaczy.
wyposażone w styk ochronny
Materiał: tworzywo sztuczne
extension socket for cable cords.
Equipped with protective contact
Material: plastic

Kanlux STAN GP

ROZGAŁĘŻNIKI, GNIAZDA, WTYCZKI STAN GP ► STAN GP SPLITTERS, SOCKETS, PLUGS



STAN GP



STAN GP	04864	5905339048646	czarny black
---------	--------------	---------------	----------------

[V] 250 AC	[Hz] 50		In[A] 16	IP 44			
----------------------	-------------------	--	--------------------	-----------------	--	--	--

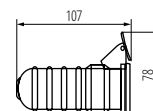

STAN GP

gniazdo wtyczkowe do przedłużaczy.
Materiał: tworzywo sztuczne
extension socket for cable cords.
Material: plastic

Kanlux ZARK

ROZGAŁĘŻNIKI, GNIAZDA, WTYCZKI ► SPLITTERS, SOCKETS, PLUGS



ZARK KRT/2-1



ZARK KRT/2-1	02180	5905339021809	biały white
ZARK KRW-3	02181	5905339021816	biały white

[V] 250 AC	[Hz] 50	[W] 2300			In[A] 16	IP 20			
----------------------	-------------------	--------------------	--	--	--------------------	-----------------	--	--	--

Brakuje Ci miejsca do podłączenia kolejnego urządzenia do kontaktu? Nic, prostszego, rozgałęźniki Kanlux ZARK rozwiążą Twój problem. Zyskasz tym samym trzy nowe wejścia do kontaktu.

wyposażony w styk ochronny
Materiał: tworzywo sztuczne

Don't you have enough room for connecting another device to the socket? Nothing simpler - Kanlux ZARK distributors will solve your problem. Thereby, you will have three new inputs to the socket.

Equipped with protective contact
Material: plastic

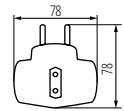

ZARK KRT/2-1

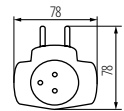

ZARK KRW-3

Kanlux APO

ZEGAR/PROGRAMATOR STERUJĄCY ► CONTROL TIMER / PROGRAMMER



APO TM-3



APO TM-3	07980	5905339079800	1150	5
----------	--------------	---------------	------	---

[V] 220-240 AC	[Hz] 50	In[A] 5	IP 20						
--------------------------	-------------------	-------------------	-----------------	--	--	--	--	--	--

Kanlux APO to komplet 3 adapterów gniazd wtyczkowych z możliwością zdalnego sterowania za pomocą pilota. Każde podłączone urządzenie możemy uruchamiać niezależnie od innych.

W komplecie: 3 gniazda, pilot, bateria

Przy obciążeniu indukcyjnym maksymalne obciążenie wynosi 1150W

Gniazda instalować można obok siebie w odległości nie mniejszej niż 0,5m

Dioda sygnalizuje pracę gniazdka elektrycznego

Zasięg działania pilota wynosi 25m (do 50m w otwartej przestrzeni)

Kanlux APO is a set of 3 adapters of extension sockets with a possibility of remote control by means of a remote control. Each connected device can be activated independently of others.

In the set: 3 sockets, remote control, battery

Maximum load with inductive load 1150W

Sockets can be installed next to one another at a distance of at least 0,5m

LED indicates that the electrical socket is operational

Remote control range 25m (up to 50m in the open space)

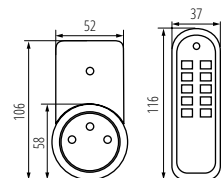

APO TM-3

Kanlux BR-GZ10

OPRAWKA DO ŹRÓDEŁ ŚWIATŁA ► LIGHT SOURCE FITTING



BR-GZ10



BR-GZ10	72369	5905339723697	szary grey
---------	--------------	---------------	--------------

[V] 250 AC	[Hz] 50	In[A] 2	GU10	IP 00				
----------------------	-------------------	-------------------	-------------	-----------------	--	--	--	--

maksymalna dopuszczalna temperatura oprawki dla BR-GZ10, HLDR-GZ10, HLDR-R7S wynosząca 250°C, dla pozostałych modeli wynosząca 180°C

maksymalny dopuszczalny prąd dla BR-GZ10, HLDR-GZ10, HLDR-G9 wynoszący 2A, dla HLDR-R7S wynoszący 6A, dla HLDR-GX5.3 wynoszący 5A

BR-GZ10 wyposażona we wspornik

Maximum permissible holder temperature 250°C for BR-GZ10, HLDR-GZ10, HLDR-R7S, for other models – 180°C

Maximum permissible current for BR-GZ10, HLDR-GZ10, HLDR-G9 – 2A, for HLDR-R7S – 6A, for HLDR-GX5.3 – 5A

BR-GZ10 equipped with a support

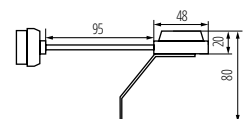

BR-GZ10

Kanlux

HLDR-E14

OPRAWKA DO ŹRÓDEŁ ŚWIATŁA ► LIGHT SOURCE FITTING



HLDR-E14



HLDR-E14 | 02170 | 5905339021700 szary | grey

[V] 250 AC	[Hz] 50	In[A] 2	E14	IP 00				
----------------------	-------------------	-------------------	------------	-----------------	--	--	--	--

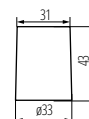

HLDR-E14

maksymalna dopuszczalna temperatura oprawki wynosząca 180°C

Maximum permissible holder temperature 180°C

Kanlux

HLDR-E14

OPRAWKA DO ŹRÓDEŁ ŚWIATŁA ► LIGHT SOURCE FITTING



HLDR-E14-F



HLDR-E14-F | 02173 | 5905339021731 szary | grey

[V] 250 AC	[Hz] 50	In[A] 2	E14	IP 00				
----------------------	-------------------	-------------------	------------	-----------------	--	--	--	--



maksymalna dopuszczalna temperatura oprawki wynosząca 180°C

Maximum permissible holder temperature 180°C

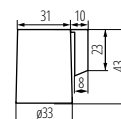

HLDR-E14-F

Kanlux

HLDR-E27

OPRAWKA DO ŹRÓDEŁ ŚWIATŁA ► LIGHT SOURCE FITTING



HLDR-E27



HLDR-E27 | 02160 | 5905339021601 szary | grey

[V] 250 AC	[Hz] 50	In[A] 4	E27	IP 00				
----------------------	-------------------	-------------------	------------	-----------------	--	--	--	--



maksymalna dopuszczalna temperatura oprawki wynosząca 180°C

Maximum permissible holder temperature 180°C

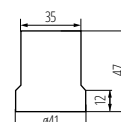

HLDR-E27

Kanlux

HLDR-E27

OPRAWKA DO ŹRÓDEŁ ŚWIATŁA ► LIGHT SOURCE FITTING



HLDR-E27-D



HLDR-E27-D | 02162 | 5905339021625 szary | grey

[V] 250 AC	[Hz] 50	In[A] 4	E27	IP 00				
----------------------	-------------------	-------------------	------------	-----------------	--	--	--	--



maksymalna dopuszczalna temperatura oprawki wynosząca 180°C
Maximum permissible holder temperature 180°C

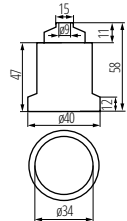

HLDR-E27-D

Kanlux

HLDR-E27

OPRAWKA DO ŹRÓDEŁ ŚWIATŁA ► LIGHT SOURCE FITTING



HLDR-E27-F



HLDR-E27-F | 02161 | 5905339021618 szary | grey

[V] 250 AC	[Hz] 50	In[A] 4	E27	IP 00				
----------------------	-------------------	-------------------	------------	-----------------	--	--	--	--



maksymalna dopuszczalna temperatura oprawki wynosząca 180°C
Maximum permissible holder temperature 180°C

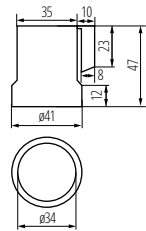

HLDR-E27-F

Kanlux

HLDR-G9

OPRAWKA DO ŹRÓDEŁ ŚWIATŁA ► LIGHT SOURCE FITTING



HLDR-G9



HLDR-G9 | 08220 | 5905339082206 szary | grey

[V] 250 AC	In[A] 2	G9	IP 00				
----------------------	-------------------	-----------	-----------------	--	--	--	--



maksymalna dopuszczalna temperatura oprawki dla BR-GZ10, HLDR-GZ10, HLDR-R7S wynosząca 250°C, dla pozostałych modeli wynosząca 180°C

maksymalny dopuszczalny prąd dla BR-GZ10, HLDR-GZ10, HLDR-G9 wynoszący 2A, dla HLDR-R7S wynoszący 6A, dla HLDR-GX5.3 wynoszący 5A

BR-GZ10 wyposażona we wspornik

Maximum permissible holder temperature 250°C for BR-GZ10, HLDR-GZ10, HLDR-R7S, for other models – 180°C

Maximum permissible current for BR-GZ10, HLDR-GZ10, HLDR-G9 – 2A, for HLDR-R7S – 6A, for HLDR-GX5.3 – 5A

BR-GZ10 equipped with a support

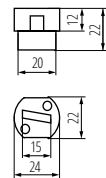

HLDR-G9

Kanlux

HLDR-GX5.3

OPRAWKA DO ŹRÓDEŁ ŚWIATŁA ► LIGHT SOURCE FITTING



HLDR-GX5.3



HLDR-GX5.3 | **72109** | 5905339721099 szary | grey

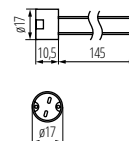

HLDR-GX5.3

maksymalna dopuszczalna temperatura oprawki dla BR-GZ10, HLDR-GZ10, HLDR-R7S wynosząca 250°C, dla pozostałych modeli wynosząca 180°C

maksymalny dopuszczalny prąd dla BR-GZ10, HLDR-GZ10, HLDR-G9 wynoszący 2A, dla HLDR-R7S wynoszący 6A, dla HLDR-GX5.3 wynoszący 5A

BR-GZ10 wyposażona we wspornik

Maximum permissible holder temperature 250°C for BR-GZ10, HLDR-GZ10, HLDR-R7S, for other models – 180°C

Maximum permissible current for BR-GZ10, HLDR-GZ10, HLDR-G9 – 2A, for HLDR-R7S – 6A, for HLDR-GX5.3 – 5A

BR-GZ10 equipped with a support

Kanlux

HLDR-GZ10

OPRAWKA DO ŹRÓDEŁ ŚWIATŁA ► LIGHT SOURCE FITTING



HLDR-GZ10



HLDR-GZ10 | **00402** | 5905339004024 szary | grey

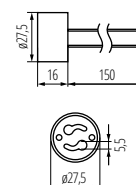

HLDR-GZ10

maksymalna dopuszczalna temperatura oprawki dla BR-GZ10, HLDR-GZ10, HLDR-R7S wynosząca 250°C, dla pozostałych modeli wynosząca 180°C

maksymalny dopuszczalny prąd dla BR-GZ10, HLDR-GZ10, HLDR-G9 wynoszący 2A, dla HLDR-R7S wynoszący 6A, dla HLDR-GX5.3 wynoszący 5A

BR-GZ10 wyposażona we wspornik

Maximum permissible holder temperature 250°C for BR-GZ10, HLDR-GZ10, HLDR-R7S, for other models – 180°C

Maximum permissible current for BR-GZ10, HLDR-GZ10, HLDR-G9 – 2A, for HLDR-R7S – 6A, for HLDR-GX5.3 – 5A

BR-GZ10 equipped with a support

Kanlux

HLDR-R7S

OPRAWKA DO ŹRÓDEŁ ŚWIATŁA ► LIGHT SOURCE FITTING



HLDR-R7S



HLDR-R7S | **00405** | 5905339004055 szary | grey

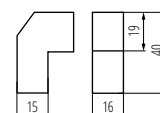

HLDR-R7S

maksymalna dopuszczalna temperatura oprawki dla BR-GZ10, HLDR-GZ10, HLDR-R7S wynosząca 250°C, dla pozostałych modeli wynosząca 180°C

maksymalny dopuszczalny prąd dla BR-GZ10, HLDR-GZ10, HLDR-G9 wynoszący 2A, dla HLDR-R7S wynoszący 6A, dla HLDR-GX5.3 wynoszący 5A

BR-GZ10 wyposażona we wspornik

Maximum permissible holder temperature 250°C for BR-GZ10, HLDR-GZ10, HLDR-R7S, for other models – 180°C

Maximum permissible current for BR-GZ10, HLDR-GZ10, HLDR-G9 – 2A, for HLDR-R7S – 6A, for HLDR-GX5.3 – 5A









BR-GZ10 equipped with a support



ONTEC S 20M1XATW



					MODE	USE		ST	AT
ONTEC S M1180MSTW	27527	5902052525256	3,3	awaryjno-sieciowy emergency and network	oświetlenie antypaniczne anti-panic lighting	3	✓		
ONTEC S 20M1XSTW	27528	5902052527533	3,6	awaryjno-sieciowy emergency, emergency and network	oświetlenie antypaniczne anti-panic lighting	1\3	✓		
ONTEC S 20M1XATW	27529	5902052527489	3,8	awaryjno-sieciowy emergency, emergency and network	oświetlenie antypaniczne anti-panic lighting	1\3		✓	
ONTEC S C1302MATW	27652	5902052502523	6,5	awaryjno-sieciowy emergency and network	oświetlenie drogi ewakuacyjnej lighting of escape routes	3		✓	
ONTEC S M1180MATW	28973	5902052521012	3,3	awaryjno-sieciowy emergency and network	oświetlenie antypaniczne anti-panic lighting	3		✓	
ONTEC S C1302MATWCLD	28977	5902052529322	6,5	awaryjno-sieciowy emergency and network	oświetlenie drogi ewakuacyjnej lighting of escape routes	3		✓	
ONTEC S C160NMATW	28978	5902052538744	1,2	awaryjno-sieciowy emergency	oświetlenie drogi ewakuacyjnej lighting of escape routes	1		✓	
ONTEC S W1302MATWCLD	33810	5902052529384	6,5	awaryjno-sieciowy emergency and network	oświetlenie drogi ewakuacyjnej lighting of escape routes	3		✓	
ONTEC S M2302MATWCLD	33818	5902052528745	6,5	awaryjno-sieciowy emergency and network	oświetlenie antypaniczne anti-panic lighting	3		✓	
ONTEC S M2102MATWCLD	33819	5902052529261	6,5	awaryjno-sieciowy emergency and network	oświetlenie antypaniczne anti-panic lighting	1		✓	
ONTEC S M5105MATW	33840	5902052529575	6,8	awaryjno-sieciowy emergency and network	oświetlenie antypaniczne anti-panic lighting	1		✓	
ONTEC S M5305MATW	33841	5902052529582	6,8	awaryjno-sieciowy emergency and network	oświetlenie antypaniczne anti-panic lighting	3		✓	
ONTEC S C2105MATW	33842	5902052531950	6,5	awaryjno-sieciowy emergency and network	oświetlenie drogi ewakuacyjnej lighting of escape routes	3		✓	
ONTEC S F2105MATW	33843	5902052529698	6,8	awaryjno-sieciowy emergency and network	oświetlenie drogi ewakuacyjnej lighting of escape routes	1		✓	
ONTEC S F2105MATW	33844	5902052529810	6,8	awaryjno-sieciowy emergency and network	oświetlenie drogi ewakuacyjnej lighting of escape routes	1		✓	
ONTEC S W1302MATW	33845	5902052541454	6,5	awaryjno-sieciowy emergency and network	oświetlenie wyjść ewakuacyjnych, urządzeń ppoż. lighting of fire exits and firefighting equipment	3		✓	
ONTEC S W2105MATWCLD	33846	5902052529445	6,8	awaryjno-sieciowy emergency and network	oświetlenie wyjść ewakuacyjnych, urządzeń ppoż. lighting of fire exits and firefighting equipment	1		✓	
ONTEC S M5105MSTW	33855	5902052529551	6,8	awaryjno-sieciowy emergency and network	oświetlenie antypaniczne anti-panic lighting	1	✓		
ONTEC S M2302MSTWCLD	33856	5902052528738	6,5	awaryjno-sieciowy emergency and network	oświetlenie antypaniczne anti-panic lighting	3	✓		
ONTEC S C1302MSTW	33862	5902052531943	6,5	awaryjno-sieciowy emergency and network	oświetlenie drogi ewakuacyjnej lighting of escape routes	3	✓		
ONTEC S F2105MSTW	33864	5902052529797	6,8	awaryjno-sieciowy emergency and network	oświetlenie drogi ewakuacyjnej lighting of escape routes	1	✓		
ONTEC S W1302MSTW	33865	5902052541447	6,5	awaryjno-sieciowy emergency and network	oświetlenie wyjść ewakuacyjnych, urządzeń ppoż. lighting of fire exits and firefighting equipment	3	✓		
ONTEC S W1302MSTWCLD	33866	5902052529377	6,5	awaryjno-sieciowy emergency and network	oświetlenie wyjść ewakuacyjnych, urządzeń ppoż. lighting of fire exits and firefighting equipment	3	✓		
ONTEC S M2302MSTW	36381	5902052528301	6,5	awaryjno-sieciowy emergency and network	oświetlenie antypaniczne anti-panic lighting	3	✓		
ONTEC S M2302MATW	36382	5902052528318	6,5	awaryjno-sieciowy emergency and network	oświetlenie antypaniczne anti-panic lighting	3		✓	

 **VI** 220-240 AC
  **Hz** 50
  **IP** 65
  **Tc** 5000
  **SMD**
 
  **CE**
  **EAC**
  **CNBOP**
  **UK**

ONTEC S

OPRAWA AWARYJNA LED ► EMERGENCY LIGHTING LED



Oświetlenie awaryjne lub antypaniczne stosuje się w pomieszczeniach typu Open Space, aby przeciwdziałać panice. Pozwala na dotarcie do miejsca, w którym widać oznaczoną drogę ewakuacji jak i oznaczenie samej drogi ewakuacyjnej zależnie od pryzmy zastosowanej w oprawie.

Materiał obudowy: tworzywo sztuczne

Materiał klosza: tworzywo sztuczne

Emergency or anti-panic lighting is used in open space rooms to prevent panic. It allows you to reach a place where you can see the marked escape route as well as for the illumination of the escape route itself, depending on the prism used in the fixture.

Enclosure material: plastic

Lampshade material: plastic



ONTEC S M1180MSTW



ONTEC S 20M1XSTW



ONTEC S 20M1XATW



ONTECSC1302MATW



ONTEC S M1180MATW



ONTEC S C1302MATWCLD



ONTEC S C160NMATW



ONTEC S W1302MATWCLD



ONTEC S M2302MATWCLD

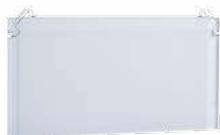

OPRAWA DWUSTRONNA OSO

AKCESORIA ► ACCESSORIES

OPRAWA DWUSTRONNA OSO	33829	5902052523870
UCHW PODT OS S2 S3 IT	33830	5902052594153
ZEST POD OR00 B	28985	5902052532032
ZEST MONT S20 FLAGA	33876	5902052531899
ZEST MONT OS05	33871	5902052523856
ZEST MONT OS205	33877	5902052552917
ZEST MON OS010 W	28974	5902052546534

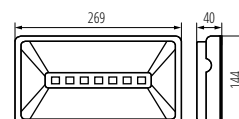

ONTEC S



ITECH



UCHW PODT OS S2 S3 IT

Oświetlenie awaryjne lub antypaniczne stosuje się w pomieszczeniach typu Open Space, aby przeciwdziałać panice. Pozwala na dotarcie do miejsca, w którym widać oznaczoną drogę ewakuacji, jak i oznaczenie samej drogi ewakuacyjnej zależnie od pryzmy zastosowanej w oprawie.

Materiał obudowy: tworzywo sztuczne

Emergency or anti-panic lighting is used in open space rooms to prevent panic. It allows you to reach a place where you can see the marked escape route as well as for the illumination of the escape route itself, depending on the prism used in the fixture.

Enclosure material: plastic



MODE

USE



ST AT

	[V]	[Hz]	IP	TECH	SMD	CE	EAC	CNBOP	UK CA		ST	AT
ITECH M1 60 NM ST W	27769	5902052537068	1,2	awaryjny emergency	oświetlenie antypaniczne anti-panic lighting	1	✓					
ITECH M2 302MATW	33812	5902052530793	6,4	awaryjno-sieciowy emergency and network	oświetlenie antypaniczne anti-panic lighting	3					✓	
ITECH M5 305MATW	33814	5902052531172	6	awaryjno-sieciowy emergency and network	oświetlenie antypaniczne anti-panic lighting	3					✓	
ITECH C1 302MATW	33815	5902052530854	6,4	awaryjno-sieciowy emergency and network	oświetlenie drogi ewakuacyjnej lighting of escape routes	3						✓
ITECH M2 302MSTW	33821	5902052530786	6,4	awaryjno-sieciowy emergency and network	oświetlenie antypaniczne anti-panic lighting	3	✓					
ITECH M5 105MSTW	33822	5902052531141	6	awaryjno-sieciowy emergency and network	oświetlenie antypaniczne anti-panic lighting	1	✓					
ITECH C1 302STW	33823	5902052530847	6,4	awaryjno-sieciowy emergency and network	oświetlenie drogi ewakuacyjnej lighting of escape routes	3	✓					
ITECH F2 105MSTW	33824	5902052531028	6	awaryjno-sieciowy emergency and network	oświetlenie drogi ewakuacyjnej lighting of escape routes	1	✓					
ITECH M5 105MATW	33832	5902052531165	6	awaryjno-sieciowy emergency and network	oświetlenie antypaniczne anti-panic lighting	1					✓	
ITECH S1 302MATW	33833	5902052541010	6,4	awaryjno-sieciowy emergency and network	oświetlenie antypaniczne anti-panic lighting	3					✓	
ITECH C2 105MATW	33834	5902052530922	6	awaryjno-sieciowy emergency and network	oświetlenie drogi ewakuacyjnej lighting of escape routes	1					✓	
ITECH F1 302MATW	33835	5902052540969	6,4	awaryjno-sieciowy emergency and network	oświetlenie drogi ewakuacyjnej lighting of escape routes	3					✓	
ITECH F2 105MATW	33836	5902052531042	6	awaryjno-sieciowy emergency and network	oświetlenie drogi ewakuacyjnej lighting of escape routes	1					✓	
ITECH W2 105MATW	33837	5902052531288	6	awaryjno-sieciowy emergency and network	oświetlenie wyjść ewakuacyjnych, urządzeń ppoż. lighting of fire exits and firefighting equipment	1					✓	
ITECH M1 60 NM AT W	33872	5902052537051	1,2	awaryjny emergency	oświetlenie antypaniczne anti-panic lighting	1						✓

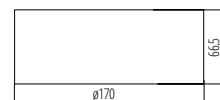

AKCESORIA ► ACCESSORIES

UCHW PODT OS S2 S3 IT | 33830 | 5902052594153

Kanlux ONTEC G

OPRAWA AWARYJNA LED ► EMERGENCY LIGHTING LED



ONTEC G

Oświetlenie awaryjne lub antypaniczne stosuje się w pomieszczeniach typu Open Space, aby przeciwdziałać panice. Pozwala na dotarcie do miejsca, w którym widać oznaczoną drogę ewakuacji jak i oznaczenie samej drogi ewakuacyjnej zależnie od przyzmy zastosowanej w oprawie.

Materiał obudowy: tworzywo sztuczne

Materiał klosza: tworzywo sztuczne

Emergency or anti-panic lighting is used in open space rooms to prevent panic. It allows you to reach a place where you can see the marked escape route as well as for the illumination of the escape route itself, depending on the prism used in the fixture.

Enclosure material: plastic

Lampshade material: plastic

					MODE	USE		ST	AT
ONTEC G E1E301 M STW	28976	5902052538638	4,8	awaryjno-sieciowy emergency and network	wyznaczanie kierunku ewakuacji marking of escape routes	3	✓		
ONTEC G E1E180MATW	28979	5902052563340	3	awaryjno-sieciowy emergency and network	wyznaczanie kierunku ewakuacji marking of escape routes	3		✓	

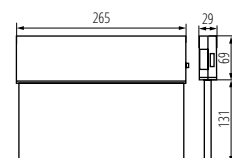

ONTEC G

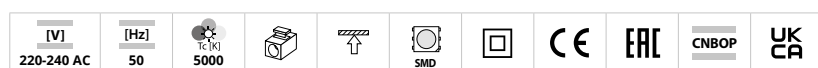

Kanlux ONTEC C

OPRAWA AWARYJNA LED ► EMERGENCY LIGHTING LED



ONTEC C M160NMATW

Oświetlenie awaryjne lub antypaniczne stosuje się w pomieszczeniach typu Open Space, aby przeciwdziałać panice. Pozwala na dotarcie do miejsca, w którym widać oznaczoną drogę ewakuacji jak i oznaczenie samej drogi ewakuacyjnej zależnie od przyzmy zastosowanej w oprawie.

Materiał obudowy: tworzywo sztuczne

Materiał klosza: tworzywo sztuczne

Emergency or anti-panic lighting is used in open space rooms to prevent panic. It allows you to reach a place where you can see the marked escape route as well as for the illumination of the escape route itself, depending on the prism used in the fixture.

Enclosure material: plastic

Lampshade material: plastic

					MODE	USE		ST	AT
ONTEC C M160NMATW	33847	5902052536269	1,2	awaryjny emergency	oświetlenie antypaniczne anti-panic lighting	1	✓		
ONTEC C M2302MATW	33848	5902052528806	7	awaryjno-sieciowy emergency and network	oświetlenie drogi ewakuacyjnej lighting of escape routes	3	✓		
ONTEC C C160NMATW	33849	5902052536504	1,2	awaryjny emergency	oświetlenie drogi ewakuacyjnej lighting of escape routes	1	✓		
ONTEC C M160NMSTW	33858	5902052536207	1,2	awaryjny emergency	oświetlenie antypaniczne anti-panic lighting	1	✓		
ONTEC C C160NMSTW	33868	5902052536443	1,2	awaryjny emergency	oświetlenie drogi ewakuacyjnej lighting of escape routes	1	✓		

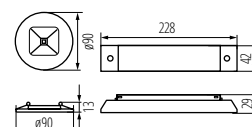

ONTEC C



ONTEC R

OPRAWA AWARYJNA LED ► EMERGENCY LIGHTING LED



ONTEC R C



ONTEC R M



ZESTAW MONT. P/T ONTEC R

Oświetlenie awaryjne lub antypaniczne stosuje się w pomieszczeniach typu Open Space, aby przeciwdziałać panice. Pozwala na dotarcie do miejsca, w którym widać oznaczoną drogę ewakuacji jak i samej ewakuacyjnej zależnie od pryzmy zastosowanej w oprawie.

Materiał obudowy: tworzywo sztuczne

Materiał klosza: tworzywo sztuczne

Emergency or anti-panic lighting is used in open space rooms to prevent panic. It allows you to reach a place where you can see the marked escape route as well as for the illumination of the escape route itself, depending on the prism used in the fixture.

Enclosure material: plastic

Lampshade material: plastic



MODE

USE



ST

AT

ONTEC R M1 60N M STW	29098	5902052535736	1,2	awaryjny emergency	oświetlenie antypaniczne anti-panic lighting	1	✓			
ONTEC R C1 60N M STW	33826	5902052535965	1,2	awaryjny emergency	oświetlenie drogi ewakuacyjnej lighting of escape routes	1	✓			
ONTEC R C1 302 M STW	33827	5902052529179	7,2	awaryjno-sieciowy emergency and network	oświetlenie drogi ewakuacyjnej lighting of escape routes	3	✓			
ONTEC R M1 60N M ATW	33850	5902052535781	1,2	awaryjny emergency	oświetlenie antypaniczne anti-panic lighting	1		✓		
ONTEC R M2 302 M ATW	33851	5902052529124	7,2	awaryjno-sieciowy emergency and network	oświetlenie antypaniczne anti-panic lighting	3		✓		
ONTEC R C1 60N M ATW	33852	5902052536023	1,2	awaryjny emergency	oświetlenie drogi ewakuacyjnej lighting of escape routes	1		✓		
ONTEC R M5 105 M STW	33860	5902052520732	6,7	awaryjno-sieciowy emergency and network	oświetlenie antypaniczne anti-panic lighting	1	✓			
ONTEC R M5 105 M ATW	33870	5902052520787	6,7	awaryjno-sieciowy emergency and network	oświetlenie antypaniczne anti-panic lighting	1		✓		

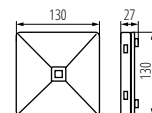
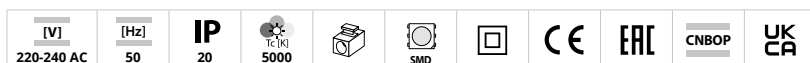

AKCESORIA ► ACCESSORIES

ZEST PODT OR00 W | **33831** | 5902052532025

ONTEC R

Kanlux

PICTO G

ZNAK EWAKUACYJNY ► EXIT SIGN



PICTO ONTEC G D5

PICTO ONTEC G D5	27482	5905339274823
PICTO ONTEC G D2	27483	5905339274830
PICTO ONTEC G D3	27484	5905339274847
PICTO ONTEC G D8	27485	5905339274854
PICTO ONTEC G D7	27488	5905339274885
PICTO ONTEC G W1	27490	5905339274908
PICTO ONTEC G F1	27497	5905339274977
PICTO ONTEC G F2	27498	5905339274984
PICTO ONTEC G DB	27499	5905339274991
PICTO ONTEC G DC	27500	5905339275004



PICTO ONTEC G D5



PICTO ONTEC G W1



PICTO ONTEC G D2



PICTO ONTEC G F1



PICTO ONTEC G D3



PICTO ONTEC G F2



PICTO ONTEC G D8



PICTO ONTEC G DB



PICTO ONTEC G D7



PICTO ONTEC G DC

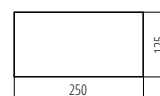

PICTO ONTEC G



PICTO ONTEC S D5

PICTO ONTEC S D5	27505	5905339275059
PICTO ONTEC S D2	27506	5905339275066
PICTO ONTEC S D3	27507	5905339275073
PICTO ONTEC S D8	27508	5905339275080
PICTO ONTEC S D1	27509	5905339275097
PICTO ONTEC S D6	27510	5905339275103
PICTO ONTEC S D7	27511	5905339275110
PICTO ONTEC S D4	27512	5905339275127
PICTO ONTEC S W1	27513	5905339275134
PICTO ONTEC S W2	27514	5905339275141
PICTO ONTEC S F1	27520	5905339275202
PICTO ONTEC S DB	27522	5905339275226
PICTO ONTEC S DC	27523	5905339275233



PICTO ONTEC S D5



PICTO ONTEC S D6



PICTO ONTEC S F1



PICTO ONTEC S D2



PICTO ONTEC S D7



PICTO ONTEC S DB



PICTO ONTEC S D3



PICTO ONTEC S D4



PICTO ONTEC S DC



PICTO ONTEC S D8



PICTO ONTEC S W1



PICTO ONTEC S D1



PICTO ONTEC S W2

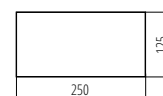

PICTO ONTEC S

Kanlux

IT

SAMOPRZYLEPNA TAŚMA IZOLACYJNA ► SELF-ADHESIVE INSULATION TAPE

IT-1: oferowane wyłącznie w opakowaniach podzbiorczych (10 szt.)

IT-1/20- MIX: unit package containing 10 pcs.

IT-1: offered only in sub-packaging (10 pcs.)



IT-1/10-B

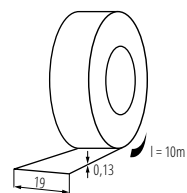

IT-1/10

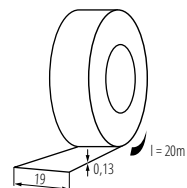

IT-1/20

IT-1/10-B	01257	5905339012579	czarny black
IT-1/20-B	01271	5905339012715	czarny black
IT-1/20-Y	01272	5905339012722	żółty yellow
IT-1/20-RE	01273	5905339012739	czzerwony red
IT-1/20-GN	01274	5905339012746	zielony green
IT-1/20-BL	01275	5905339012753	niebieski blue
IT-1/20-W	01276	5905339012760	biały white
IT-1/20-Y/GN	01277	5905339012777	żółty / zielony yellow / green
IT-1/20-MIX	01283	5905339012838	wielokolorowy multicoloured



STOSOWANE IKONKI USED SYMBOLS



IP Objaśnienia stopnia odporności na wnikanie ciał stałych, pyłu i wilgoci Explanation of degree of resistance to penetration of foreign solids, dust and humidity

Stopień zabezpieczenia przed nieumyślnym kontaktem z częściami pod napięciem
Degree of protection against inadvertent contact with the live parts

IP	Rysunek / Picture	Opis / Description	Wyjaśnienie / Explanation
0		Brak ochrony No protection	Brak specjalnych środków ochrony No special protection means
1		Ochrona przed ciałami stałymi o wielkości ponad 50mm Protection against solids bigger than 50mm	Duża powierzchnia ciała ludzkiego, równa np. powierzchni dłoni (brak zabezpieczenia przed dotykiem). Ciała stałe o średnicy ponad 50mm Large parts of a human body, equal to e.g. the area of a palm (no protection against touching). Solids with the diameter above 50mm
2		Ochrona przed ciałami stałymi przekraczającymi 12mm Protection against solids bigger than 12mm	Palec lub podobne przedmioty o długości nie przekraczającej 80mm. Ciała stałe o średnicy nie przekraczającej 12mm A finger or similar objects not longer than 80mm. Solids with the diameter above 12mm
3		Ochrona przed ciałami stałymi przekraczającymi 2,5mm Protection against solids bigger than 2,5mm	Narzędzia, drut, itp. o średnicy lub grubości przekraczającej 2,5mm. Ciała stałe o średnicy powyżej 2,5mm Tools, a wire etc. with the diameter or the wire gauge exceeding 2,5mm. Solids with the diameter above 2,5mm
4		Ochrona przed ciałami stałymi przekraczającymi 1mm Protection against solids bigger than 1mm	Drut lub taśma o grubości 1mm. Ciała stałe o średnicy przekraczającej 1mm A wire or a strip 1mm thick. Solids with the diameter above 1mm
5		Pyłoodporność Dust resistance	Niewielka ilość pyłu przedostaje się do wnętrza osłony, lecz jest tak mała, że nie wywiera ujemnego wpływu na pracę wyposażenia Small amount of dust penetrates the shield interior but it is so small that it does not exert a negative influence on the equipment operation
6		Pyłoszczelność Dust-proofing	Pył nie przedostaje się do wnętrza osłony Dust does not penetrate the shield interior

Stopień zabezpieczenia przed wilgocią
Degree of protection against moisture

IP	Rysunek / Picture	Opis / Description	Wyjaśnienie / Explanation
0		Brak ochrony No protection	Brak specjalnych środków ochrony No special protection measures
1		Ochrona przed pionowo wpadającymi kroplami wody Protection against vertically falling water drops	Padające pionowo krople wody nie mogą wywołać szkodliwych skutków w urządzeniu Vertically falling water drops cannot cause detrimental effects within the equipment
2		Ochrona przed kroplami wody przy przechyleniu do 15° Protection against water drops at up to 15-degree angle of deflection	Padające pionowo krople wody nie mogą wywołać szkodliwych skutków przy przechyleniu osłony do 15° względem położenia normalnego Vertically falling water drops cannot cause detrimental effects within the equipment when the shield is tilted up to 15 degrees from its normal position
3		Ochrona przed rozpyloną wodą Protection against sprayed water	Rozpylona woda padająca pod kątem 60° od pionu nie powinna wywołać szkodliwych efektów Sprayed water falling at a 60-degree angle of deflection from the vertical should not cause detrimental effects
4		Ochrona przed bryzgami wody Protection against water splashes	Woda rozbrzygiwana na osłonę z dowolnego kierunku nie powinna wywołać szkodliwych skutków Water splashed onto the shield from any direction should not cause detrimental effects
5		Ochrona przed strugami wody Protection against water streams	Woda z dyszy skierowana na obudowę z dowolnego kierunku nie powinna wywołać szkodliwych skutków Water from a nozzle directed onto the casing from any direction should not cause detrimental effects
6		Ochrona przed falami Protection against waves	Woda po zalaniu falą lub od silnej strugi nie może dostać się do wnętrza osłony w takiej ilości, aby wywołać szkodliwe skutki A flooding water wave or a strong stream cannot penetrate the shield in the amount causing detrimental effects
7		Ochrona przed zanurzeniem Protection against immersion	Przy zanurzeniu urządzenia do wody na określony czas i przy określonym ciśnieniu, woda nie może dostać się do wnętrza osłony w takiej ilości, aby wywołać szkodliwe skutki When the equipment is immersed in water for the predetermined time and at the predetermined pressure, water cannot penetrate the shield in the amount causing detrimental effects
8		Ochrona przed głębokim zanurzeniem Protection against deep immersion	Urządzenie dostosowane do długotrwałego zanurzenia w wodzie w warunkach określonych przez wytwórcę The equipment adapted to long-lasting immersion in water in the conditions specified by the manufacturer

STOSOWANE IKONKI USED SYMBOLS



Klasa bezpieczeństwa Safety class	Symbol Symbol	Wyjaśnienie Explanation
0	Brak None	Ochronę przed porażeniem elektrycznym stanowi izolacja podstawowa. W przypadku uszkodzenia izolacji ochronę przeciwporażeniową powinny zapewnić odpowiednio korzystne warunki środowiskowe oraz położenie urządzenia poza dotykiem bezpośrednim Protection against electrical shock is guaranteed by the basic isolation. In case that the isolation is damaged, the anti-shock protection should be guaranteed by the appropriately favourable environmental conditions and the equipment location beyond the direct touch
I		W urządzeniach z I klasą ochronności bezpieczeństwo zapewnione jest poprzez połączenie wszystkich czynnych przewodzących elementów z przewodem ochronnym lub bezpośrednio z uziemieniem In the equipment of the I class protection the safety is guaranteed through connection of all active conducting elements with a protective conductor or directly with the grounding
II		W urządzeniach z II klasą ochronności bezpieczeństwo zapewnione jest przez zastosowanie izolacji podwójnej lub wzmocnionej, której w danych warunkach środowiskowych i przy napięciu znamionowym uważa się za nie do przebicia In the equipment of the II class protection the safety is guaranteed through the application of double or reinforced isolation, which in the given environmental conditions and at the rated voltage is considered unbreakable
III		Ochrona przeciwporażeniowa w urządzeniach III klasy ochronności jest zapewniona przez obniżenie napięcia zasilania do wartości bezpiecznej w danych warunkach środowiskowych The anti-shock protection in the III class equipment is guaranteed through decreasing of the supply voltage to the value which is safe in the given environmental conditions

Temperatura barwowa T_c [K] to temperatura ciała doskonale czarnego, w której wysyła ono promieniowanie świetlne o tej samej barwie co źródło rozpatrywane. Jest to więc to obiektyw-
na miara wrażenia barwy danego źródła światła

Colour temperature T_c [K] is the temperature of a perfect radiator at which it sends visible radiation of the same colour as the colour of the examined source. This is hence an objective
measure of the colour impression of the given source of light

<2700K	Barwa żółto-biała	Yellow-white colour
2700-3300K	Barwa ciepłobiała	Warm white colour
3300-5300K	Barwa neutralna (biała)	Neutral colour (white)
>5300K	Barwa dzienna (chłodnobiała)	Daylight colour (cool white)

STOSOWANE IKONKI USED SYMBOLS



27395	kod Kanlux / Kanlux code
5902052559695	kod EAN / EAN code
	kolor / colour
	napięcie znamionowe / rated voltage
	zasilanie świetlówek T8 LED jednostronne/ the range of humidity to which the product is adapted
	moc / power
	częstotliwość znamionowa / rated frequency
	napięcie wejściowe / input voltage
	napięcie wyjściowe / output voltage
	prąd wyjściowy / output current
	prąd znamionowy / rated current
	roczne zużycie energii / annual energy consumption
	ilość cykli włącz/wyłącz / number on/of switch cycles
	deklaracja równoważności dotycząca mocy / declaration of equivalence regarding power
	niewymienne źródło światła / non-replaceable light source
	wymienne źródło światła / replaceable light source
	temperatura barwowa (Tc) / colour temperature (Tc)
	barwa światła / colour temperature
	skuteczność świetlna / luminous efficiency
	jednolitość barw [SDCM] / color uniformity [SDCM]
	strumień świetlny / luminous flux

	użyteczny strumień świetlny / useful luminous flux
	współczynnik oddawania barw Ra / color rendering index Ra
	zakres temperatury otoczenia do jakiej przystosowany jest produkt / ambient temperature range to which the product is adapted
	zakres wilgotności powietrza do jakiej przystosowany jest produkt / the range of humidity to which the product is adapted
	kąt rozsyłu światła / light beam angle
	trwałość / durability
	klasa efektywności energetycznej (Ei) / energy efficiency class (Ei)
	nie stosować w obwodach z urządzeniami elektronicznymi (np.: ze ściemniaczem) / do not use in circuits with electronic de- vices (e.g. dimmer)
	możliwość współpracy ze ściemniaczem / the possibility of cooperation with a dimmer
	możliwość współpracy ze ściemniaczem 1-10V / possibility of cooperation with 1-10V dimmer*
	możliwość współpracy ze ściemniaczem DALI / possibility of cooperation with DALI dimmer
	wyposażone we włącznik / equipped with a switch
	wyposażony w higrometr / equipped with a hygrometer
	wyposażony we włącznik czasowy / equipped with a timer
	wyposażony we włącznik pociągany / equipped with a pull switch
	brak rtęci / no mercury
	zawartość rtęci / mercury content
	minimalna odległość od oświetlanego obiektu / the minimum distance from the illuminated object
	współczynnik mocy / power factor
	długość / length
	UGR / UGR
	oprawa ruchoma w zakresie horyzontalnym / horizontally movable fitting
	oprawa ruchoma w zakresie wertykalnym / vertically movable fitting

	oprawa stała / stationary fitting
	regulacja kątowa oprawy oświetleniowej [°] / angle adjustment of the lighting fixture [°]
	regulacja kątowa oprawy oświetleniowej w dwóch osiach / angle adjustment of the lighting fixture in two axes
	regulacja kątowa oprawy oświetleniowej w jednej osi / angle adjustment of the lighting fixture in one axis
	otwór montażowy / mounting hole
	rodzaj statecznika: elektroniczny / ballast type: electronic
	rodzaj statecznika: indukcyjny / ballast type: inductive
	rodzaj zasilania - stałonapięciowy / type of power supply - constant voltage
	rodzaj zasilania - stałoprądowy / type of power supply - constant current
	stopień odporności na wnikanie ciał stałych i wilgoci (IP) / solids and humidity penetration protection degree (IP)
	stopień określający ochronę przed uderze- niami mechanicznymi / degree of protection against mechanical impacts
	do zastosowania wewnątrz / for indoor use
	do zastosowania na zewnątrz / for outdoor use
	do zastosowania wewnątrz lub na zewnątrz / for indoor or outdoor use
	zgodność z normami europejskimi (CE) / compliance with European standards (CE)
	certifikat Zgodności potwierdzający jakość produkcji z zatwierdzonymi standardami na terytorium Unii Celnej / certificate of Conformity confirming the quality of production in accordance with approved standards on the territory of the Customs Union
	wyrób spełnia wymagania przepisów stosowanych w Wielkiej Brytanii (UK) / the product is compliant with all relevant United Kingdom regulations
	wyrób spełnia wymagania przepisów stosowanych w Ukrainie / the product is compliant with all relevant Ukraine regulations
	klasa ochronności przed porażeniem elektrycznym I / class of protection against electric shock I
	klasa ochronności przed porażeniem elektrycznym II / class of protection against electric shock II

STOSOWANE IKONKI USED SYMBOLS



	klasa ochronności przed porażeniem elektrycznym III / class of protection against electric shock III
	lampa nie jest przeznaczona do oświetlenia akcentowego / the lamp is not designed for accent lighting
	lampa jest przeznaczona do oświetlenia akcentowego / the lamp is designed for accent lighting
	możliwość montażu na powierzchniach normalnie palnych / can be mounted on normally flammable surfaces
	źródło światła w komplecie / light source included
	baterie nadajnika / Transmitter batteries
	sterowanie: RF 2,4 GHz / control: RF 2,4 GHz
	przewód zakończony wtyczką - DC / cable terminated with a plug - DC

typ źródła światła / light source type

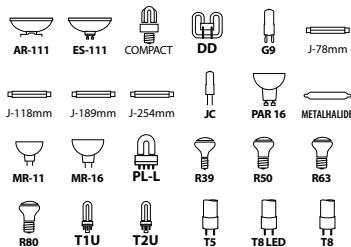

trzonek / cap

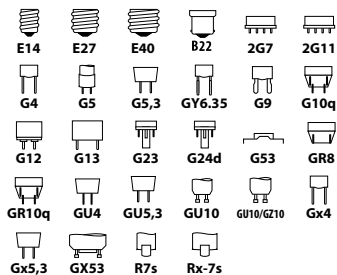

rodzaj diody / LED type

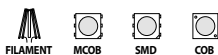

kierunek świecenia / lighting direction



rodzaj przyłącza / type of connection

	kostka śrubowa / screw cube
	kostka przyłączeniowa / connection block
	kostka samozaciskowa / self-locking cube
	przewód zakończony wtyczką / cable with a plug
	wolne końce przewodów / free cable ends
	średnica przewodu / wire diameter
	długość przewodu / cable length
	zakres przekrojów stosowanych przewodów / range of cross-sections of cables used
	długość przewodu zasilacza zakończony wtyczką / length of the power cord terminated with a plug

montaż / assembly

	do nabudowania na ścianie / wall-mounted
	do wbudowania w ścianę / wall recessed
	do nabudowania na suficie / ceiling-mounted
	do wbudowania w sufit / ceiling recessed
	do wbudowania w sufit lub ścianę / ceiling or wall recessed
	do nabudowania na podłożu / foundation-mounted
	do wbudowania w podłoże / foundation recessed
	do nabudowania na suficie, ścianie lub podłożu / ceiling-, wall- or foundation- mounted
	na szynie TH35 / rail TH35
	na szynie TEAR / rail TEAR
	do zawieszenia na suficie / for hanging on the ceiling

rodzaj czujnika / type of sensor

	PIR
	micro wave
	2 x PIR
	3 x PIR
	charakterystyka wyzwalania / trigger characteristics
	czas działania czujnika / sensor operation time

	kąt działania czujnika / sensor operating angle
	zasięg czujnika / sensor range
	nastawa poziomu natężenia oświetlenia, przy którym czujnik wykrywa ruch / setting the brightness level at which the sensor detects movement
	głośność / loudness
	objętościowy przepływ powietrza [m3/h] / the volumetric air flow [m3/h]
	obroty silnika / engine speed
	ilość biegunów / number of poles
	liczba modułów / number of modules
	zastosowanie / application
	tryb pracy / operating mode
	test standardowy / standard test
	test automatyczny / automatic test
	czas pracy awaryjnej / emergency operation time

INDEKS ALFABETYCZNY

ALPHABETICAL INDEX

ABETE LED 60 GR	36570	285	ALIN LED LINE	xxx	18
ABETE LED 80 GR	36571	285	ALOR DSL-B	26727	169
ABETE LED EL 20 GR	36572	285	ALOR DSL-W	26726	169
ABETE LED EL 20 SE-GR	36573	285	ALOR DSO-B	26791	169
ADI 350 1x3W	1440	335	ALOR DSO-W	26790	169
ADTR	xxx	30	ALOR DTL-B	26732	169
ADTR 12030 B	27614	213	ALOR DTL-W	26731	169
ADTR 12030 B	27614	209	ALOR DTO-B	26796	169
ADTR 12030 SR	27612	213	ALOR DTO-W	26795	169
ADTR 12030 SR	27612	209	ALREN DTL-B	26754	176
ADTR 12030 W	27611	213	ALREN DTL-C/M	26756	176
ADTR 12030 W	27611	209	ALREN DTL-W	26753	176
ADTR 3060 B	29842	213	ALREN R DTL-B	26757	176
ADTR 3060 SR	29841	213	ALREN R DTL-W	26758	176
ADTR 3060 W	29840	213	AMAZI LED 17,5W NW B	37325	116
ADTR 6060 B	27615	213	ANTEM LED 100W-NW B	33204	266
ADTR 6060 B	27615	209	ANTEM LED 10W-NW B	33200	266
ADTR 6060 SR	27610	213	ANTEM LED 10W-NW-SE B	33205	266
ADTR 6060 SR	27610	209	ANTEM LED 20W-NW B	33201	266
ADTR 6060 W	27613	213	ANTEM LED 20W-NW-SE B	33206	266
ADTR 6060 W	27613	209	ANTEM LED 30W-NW B	33202	266
ADTR-H 12030 B	33391	209	ANTEM LED 30W-NW-SE B	33207	266
ADTR-H 12030 SR	33392	209	ANTEM LED 50W-NW B	33203	266
ADTR-H 12030 W	33390	209	ANTEM LED 50W-NW-SE B	33208	266
ADTR-H 12030 W	33390	211	APO TM -3	7980	340
ADTR-H 3060 W	33393	211	APRILA DTO-W	26738	165
ADTR-H 6060 B	29845	209	APUS LED AC B-NW	26536	196
ADTR-H 6060 SR	29844	209	APUS LED AC B-WW	26537	196
ADTR-H 6060 W	29843	209	APUS LED AC-CW	23801	196
ADTR-H 6060 W	29843	211	APUS LED AC-WW	23800	196
ADTR-H 6262 W	33435	209	APUS LED B-NW	26538	196
ADTR-H 76MM 6060 W	33398	209	APUS LED B-WW	26539	196
ADTR-S 6060 W	27616	209	APUS LED CW	23107	196
ADTR-S-H 6060 W	27617	209	APUS LED NW	32488	196
AGEO DSO-B	33165	165	APUS LED PIR B-NW	29856	196
AGEO DSO-W	33166	165	APUS LED PIR B-WW	29857	196
AGZAR C 3xE14 B	36252	104	APUS LED PIR NW	27379	196
AGZAR C 3xE14 W	36253	104	APUS LED PIR WW	27370	196
AGZAR E14 B	36250	144	APUS LED W-CW	26841	196
AGZAR E14 W	36251	144	APUS LED W-NW	27378	196
AGZAR EL-10 B	36254	144	APUS LED W-W	23106	196
AGZAR EL-10 W	36255	144	APUS LED W-WW	26840	196
AKVEN LED	25720	300	AQILO E14 IP65 DSO-B	36642	108
AKVO IP44 15W-NW-B	36660	193	AQILO E14 IP65 DSO-GR	36640	108
AKVO IP44 15W-NW-B S	36651	192	AQILO E14 IP65 DSO-W	36641	108
AKVO IP44 15W-NW-C	36661	193	AQILO E27 IP65 DSO-B	36645	108
AKVO IP44 15W-NW-C S	36652	192	AQILO E27 IP65 DSO-GR	36643	108
AKVO IP44 15W-NW-W	36659	193	AQILO E27 IP65 DSO-W	36644	108
AKVO IP44 15W-NW-W S	36650	192	AQILO IP65 DSO-B	33361	108
AKVO IP44 20W-NW-B	36663	193	AQILO IP65 DSO-GR	33362	108
AKVO IP44 20W-NW-B S	36654	192	AQILO IP65 DSO-W	33360	108
AKVO IP44 20W-NW-C	36664	193	AREL FRAME DO 14W W	33651	252
AKVO IP44 20W-NW-C S	36655	192	AREL LED DL 10W-NW	29586	252
AKVO IP44 20W-NW-W	36662	193	AREL LED DL 14W-NW	29590	252
AKVO IP44 20W-NW-W S	36653	192	AREL LED DL 6W-NW	29582	252
AKVO IP44 23W-NW-B	36666	193	AREL LED DO 10W-NW	29584	252
AKVO IP44 23W-NW-B S	36657	192	AREL LED DO 10W-WW	29585	252
AKVO IP44 23W-NW-C	36667	193	AREL LED DO 14W-NW	29588	252
AKVO IP44 23W-NW-C S	36658	192	AREL LED DO 14W-WW	29589	252
AKVO IP44 23W-NW-W	36665	193	AREL LED DO 6W-NW	29580	252
AKVO IP44 23W-NW-W S	36656	192	AREL LED DO 6W-WW	29581	252
ALDO 4LED 1X120	26361	228	ARET 1XMR16-W	26720	175
ALDO 4LED 1X150	26362	228	ARET 2XMR16-W	26723	175
ALDO 4LED 1X60	26360	228	ARGUS II CT-2114-AN	37150	182
ALDO 4LED 2X120	26364	228	ARGUS II CT-2114-BR/M	37151	182
ALDO 4LED 2X150	26365	228	ARGUS II CT-2114-C	37152	182
ALER JQ-30-B	461	326	ARGUS II CT-2114-C/M	37153	182
ALER JQ-30-W	460	326	ARGUS II CT-2114-G	37154	182
ALER MINI-W	23450	326	ARGUS II CT-2114-GM	37155	182
ALER N-B	37363	322	ARGUS II CT-2114-W	37156	182
ALER N-W	37362	322	ARGUS II CT-2115-AN	37157	182
ALIN 4LED	xxx	20	ARGUS II CT-2115-BR/M	37158	182
ALIN 4LED LINE	xxx	22	ARGUS II CT-2115-C	37159	182
ALIN LED	xxx	16	ARGUS II CT-2115-C/M	37160	182

ARGUS II CT-2115-G	37161	182	BLINGO 34W 4080 60CW	37172	208
ARGUS II CT-2115-GM	37162	182	BLINGO 34W 4080 60NW	37171	208
ARGUS II CT-2115-W	37163	182	BLINGO 38W 4560 120NW	37177	208
ARVOS LED 37W CCT B	37330	120	BLINGO 38W 4560 60NW	37176	208
ARVOS LED 37W CCT W	37331	120	BLINGO DALI SET 38W	28515	211
ASTEN IP44 12W-NW-B	26684	190	BLINGO DALI SET 38W	28515	211
ASTEN IP44 12W-NW-W	26687	190	BLINGO DRV 24W ON-OFF	37272	211
ASTEN IP44 15W-NW-B	26685	190	BLINGO DRV 24W ON-OFF	37272	211
ASTEN IP44 15W-NW-W	26688	190	BLINGO DRV 32W ON-OFF	37269	211
ASTEN IP44 8W-NW-B	26683	190	BLINGO DRV 32W ON-OFF	37269	211
ASTEN IP44 8W-NW-W	26686	190	BLINGO DRV 40W ON-OFF	37270	211
ASTEN LED IP44 12W-NW	26681	190	BLINGO DRV 40W ON-OFF	37270	211
ASTEN LED IP44 15W-NW	26682	190	BLINGO DRV40W1-10V BK	37268	211
ASTEN LED IP44 8W-NW	26680	190	BLINGO DRV40W1-10V BK	37268	211
ASTIM IP44 12W-NW-B	34933	189	BLINGO DRV42W DALI BK	37267	211
ASTIM IP44 12W-NW-C	34935	189	BLINGO DRV42W DALI BK	37267	211
ASTIM IP44 12W-NW-W	34934	189	BLINGO PU 36W 6262 NW	33188	208
ASTIM IP44 8W-NW-B	34930	189	BLINGO TN24-28W6060NW	33178	208
ASTIM IP44 8W-NW-C	34932	189	BLINGO TN38W 6060 NW	33177	208
ASTIM IP44 8W-NW-W	34931	189	BLINGO TUN48W 6060 NW	33179	208
ATL1 18W-930-S6-B	33131	304	BLINGO U EI25LM 120NW	37266	210
ATL1 18W-930-S6-W	33130	304	BLINGO U EI25LM 30NW	37271	210
ATL1 18W-940-S6-B	33133	304	BLINGO U EI25LM 60NW	37265	210
ATL1 18W-940-S6-W	33132	304	BLINGO U24W 4000 60NW	37179	208
ATL1 30W-930-S6-B	33135	304	BLINGO U34W 4080 120N	37175	208
ATL1 30W-930-S6-W	33134	304	BLINGO U34W 4080 60NW	37173	208
ATL1 30W-940-S6-B	33137	304	BLURRO 2xGU10 CO-B	32952	113
ATL1 30W-940-S6-W	33136	304	BLURRO 2xGU10 CO-W	32953	113
ATL2 GU10-B	33139	306	BOLA LED 2xUSB WW W	37397	140
ATL2 GU10-W	33138	306	BONSA LED 17,5W NW	37322	115
ATL3 GU10-B	33144	306	BORD DLP-50-B	22552	111
ATL3 GU10-W	33145	306	BORD DLP-50-W	22551	111
ATL4 GU10-B	33146	307	BORD XS DLP-50-B	25478	112
ATL4 GU10-W	33147	307	BORD XS DLP-50-W	25479	112
ATL5 GU10-B	33148	307	BRAVO DALI SET 36W	28508	212
ATL5 GU10-W	33149	307	BRAVO DRIVER 28W	28029	212
AVAR 6060 40W-CW	26771	214	BRAVO DRIVER 36W	28025	212
AVAR 6060 40W-NW	26770	214	BRAVO DRIVER 40W	28026	212
AVAR 6262 40W-NW	26773	214	BRAVO PU28W3060NW W	28551	212
AVAR 6262 40W-WW	26774	214	BRAVO PU36W6060NW W	28002	212
AVAR DALI SET 40W	28512	214	BRAVO S 40W12030NW W	28022	212
AZ-10A	22371	333	BRAVO S 40W6060NW W	28010	212
BART EL-235	7080	277	BRAVO S/P GRIP 12030	28501	213
BENO 18W NW-L-SE W	32946	233	BRAVO S/P GRIP 60-62	28500	213
BENO 18W NW-L-W	32942	233	BR-GZ10	72369	340
BENO 18W NW-O-SE W	32944	233	BTL 18W-930-B	35651	308
BENO 18W NW-O-W	32940	233	BTL 18W-930-W	35650	308
BENO 24W NW-L-GR	33343	233	BTL 18W-940-B	35653	308
BENO 24W NW-L-SE GR	33347	233	BTL 18W-940-W	35652	308
BENO 24W NW-L-SE W	33346	233	BTL 28W-930-B	35655	308
BENO 24W NW-L-W	33342	233	BTL 28W-930-W	35654	308
BENO 24W NW-O-GR	33341	233	BTL 28W-940-B	35657	308
BENO 24W NW-O-SE GR	33345	233	BTL 28W-940-W	35656	308
BENO 24W NW-O-SE W	33344	233	BTL 38W-930-B	35659	308
BENO 24W NW-O-W	33340	233	BTL 38W-930-W	35658	308
BENO N 18W NW-L-SE GR	32949	233	BTL 38W-940-B	35661	308
BENO N 18W NW-O-SE GR	32948	233	BTL 38W-940-W	35660	308
BERG AD-7L	276	282	BTLW 18W-930-B	35663	309
BERG AD-7O	36430	282	BTLW 18W-930-W	35662	309
BERG DL-10L	7173	282	BTLW 18W-940-B	35665	309
BERG DL-10O	7172	282	BTLW 18W-940-W	35664	309
BILO 4,9W E14-NW	23428	64	CALIZA LED CCT W	37390	142
BILO 4,9W E14-WW	23429	64	CARSA V2LED 12W-NW-W	28948	260
BILO 4,9W E27-NW	23418	64	CARSA V2LED 18W-NW-W	28949	260
BILO 4,9W E27-WW	23419	64	CARSA V2LED 24W-NW-W	33541	260
BILO 6,5W E14-NW	26766	64	CARVO LED 17,5W NW	37321	114
BILO 6,5W E14-WW	26767	64	CHIRO GU10 DTL-B	29313	162
BILO 6,5W E27-NW	26768	64	CHIRO GU10 DTO-B	29311	162
BILO 6,5W E27-WW	26769	64	CHIRO GU10 DTO-W	29310	162
BISO LED EL 8W-GR	29260	275	CIRCO LED 12VDC 0-10W	24240	336
BISO LED EL 8W-W	29261	275	CIRCO LED 12VDC 0-15W	24241	336
BLINGO 24W 4320 60NW	37178	208	CLIPS BRAVO S/P 12030	28503	213
BLINGO 34W 3740 60WW	37170	208	CLIPS BRAVO S/P 60-62	28502	213
BLINGO 34W 4080 120NW	37174	208	CLIPS PANEL 120	37338	209

INDEKS ALFABETYCZNY

ALPHABETICAL INDEX

CLIPS PANEL 120	37338	211	ELICEO DSO W	35288	172
CLIPS PANEL 60-62	37337	209	ELICEO DSO W/G	35283	172
CLIPS PANEL 60-62	37337	211	ELICEO DSO W/W	35281	172
CL-MAH PLUS	18593	225	ELICEO DSO YG	35295	172
CL-MAH PLUS-INOX	18594	225	ELICEO-ST DSO B/B	35284	172
CLP-REGIS/PT	72333	216	ELICEO-ST DSO W/G	35287	172
CLP-REGIS/PT	72333	217	ELICEO-ST DSO W/W	35285	172
COB SET 3m DIM-NW	26327	86	ELNIS L A	27809	170
COB SET 3m DIM-WW	26326	86	ELNIS L A/C	27808	170
COLIE DTO-B	26743	177	ELNIS L B/G	27810	170
COLIE DTO-G	26741	177	ELNIS L W	27804	170
COLIE DTO-GR	26744	177	ELNIS L W/A	27805	170
COLIE DTO-W	26740	177	ELNIS L W/C	27806	170
CONNECT C/D/E/I	26563	89	ELNIS S W	27800	170
CONNECT C/D/E/I	26563	90	ENALI EL-10 B	28761	136
CONNECT-L B	26604	88	ENALI EL-10 W	28760	136
CONNECT-L C	26562	89	ENALI EL-2I B	28763	136
CONNECTOR 8	19030	79	ENALI EL-2I W	28762	136
CONNECTOR 8-CP	19032	79	ENALI EL-3I B	28767	136
CONNECTOR 8-CPC	19033	79	ENALI EL-3I W	28766	136
CONNECTOR RGB 10	19038	85	ENALI EL-3O B	28765	136
CONNECTOR RGB 10-CP	19036	85	ENALI EL-3O W	28764	136
CONNECTOR RGB 10-CPC	19037	85	ENALI EL-4I B	28769	136
CONTROLLER LED RGB-RF	22140	85	ENALI EL-4I W	28768	136
CTR L 12/24V MONO/CTT	22147	87	ERINUS LED L B-NW	33333	194
CTR L 12/24V RG BW CTT	22148	87	ERINUS LED L B-WW	33332	194
CYBER TM -6	1016	334	ERINUS LED L GR-NW	33327	194
CYKLON EOL 100	70910	338	ERINUS LED L W-NW	33321	194
CYKLON EOL 100B	70911	338	ERINUS LED L W-WW	33320	194
CYKLON EOL 100HT	70936	338	ERINUS LED LL B-NW	33337	194
CYKLON EOL 100P	70937	338	ERINUS LED LL B-WW	33336	194
CYKLON EOL 100T	70938	338	ERINUS LED LL GR-NW	33331	194
CYKLON EOL 120	70915	338	ERINUS LED LL GR-WW	33330	194
CYKLON EOL 120B	70916	338	ERINUS LED LL W-NW	33325	194
CYKLON EOL 120HT	70941	338	ERINUS LED LL W-WW	33324	194
CYKLON EOL 120P	70942	338	ERINUS LED O B-NW	33335	194
CYKLON EOL 120T	70943	338	ERINUS LED O B-WW	33334	194
CYKLON EOL 150	70920	338	ERINUS LED O GR-NW	33329	194
CYKLON EOL 150B	70921	338	ERINUS LED O W-NW	33323	194
CYKLON EOL 150P	70947	338	ERINUS LED O W-WW	33322	194
CYKLON EOL 150T	70948	338	ERTON 140 OP-W	35770	244
DABA N LED SMD DL-16W	19062	238	ERTON 240 OP-W	35771	244
DABA PRO 25W NW-B	19065	238	ESG LED 9W GX53-CW	22424	77
DABA PRO 26W NW-SE-W	19066	238	ESG LED 9W GX53-NW	22423	77
DALLA CT-DTL50-B	22433	171	ESG LED 9W GX53-WW	22422	77
DALLA CT-DTL50-W	22431	171	ETISSA D20 GR	27000	106
DALLA CT-DTO50-B	22432	171	EVALO EL-1I B-SR	35691	126
DALLA CT-DTO50-W	22430	171	EVALO EL-1I W-SR	35690	126
DASTO 2SOC FR B	36585	302	EVALO EL-2I B-SR	35693	126
DERATO EL-10 B-SR	35640	124	EVALO EL-2I W-SR	35692	126
DERATO EL-10 W-SR	35641	124	EVALO EL-3I B-SR	35695	126
DERATO EL-2I B-SR	35642	124	EVALO EL-3I W-SR	35694	126
DERATO EL-2I W-SR	35643	124	EVALO EL-4I B-SR	35699	126
DERATO EL-3O B-SR	35644	124	EVALO EL-4I W-SR	35698	126
DERATO EL-3O W-SR	35645	124	EVALO EL-4O B-SR	35697	126
DERATO EL-4I B-SR	35646	124	EVALO EL-4O W-SR	35696	126
DERATO EL-4I W-SR	35647	124	EVALO EL-5I B-SR	35689	126
DRIVE LED 0-15W 12VDC	23860	336	EVALO EL-5I W-SR	35688	126
DROXY IP65 DSO-B	33126	186	EVALO FL 3xGU10 B-SR	35788	149
DROXY IP65 DSO-W	33125	186	EVALO FL 3xGU10 W-SR	35787	149
DULI LED 4W-NW-L-GR	33750	278	EVALO TL GU10 B-SR	35786	148
DULI LED 4W-NW-O-GR	33751	278	EVALO TL GU10 W-SR	35785	148
DULI LED 6,5W-NW-L-GR	33752	278	EVIT CT-DTL50-AL	18560	178
DULI LED 6,5W-NW-O-GR	33753	278	EVIT CT-DTO50-AL	18561	178
DUN 4,9W E14-NW	23435	59	EXATE LED 17,5W NW	37323	115
DUN 4,9W E14-WW	23434	59	FELINE DSL B/B	37256	159
DUN 6,5W E14-NW	23436	59	FELINE DSL B/W	37260	159
DUN 6,5W E14-WW	23437	59	FELINE DSL G/B	37257	159
ELICEO DSO B	35289	172	FELINE DSL G/W	37261	159
ELICEO DSO B/B	35280	172	FELINE DSL W/B	37258	159
ELICEO DSO BL	35298	172	FELINE DSL W/W	37259	159
ELICEO DSO GR	35296	172	FELINE DSO B/B	37250	158
ELICEO DSO PK	35297	172	FELINE DSO B/W	37255	158

FELINE DSO G/B	37251	158	GLOZO DSO SR/B	36225	156
FELINE DSO G/W	37254	158	GLOZO DSO SR/W	36221	156
FELINE DSO W/B	37252	158	GLOZO DSO W/B	36222	156
FELINE DSO W/W	37253	158	GLOZO DSO W/W	36218	156
FL AGOR HI 240W NW	33476	263	GORD XS DLP 50-B	25476	112
FL AGOR HI 300W NW	33478	263	GORD XS DLP 50-W	25477	112
FL AGOR HI GRID 240W	33482	263	GORDO N 1W CW-L-SR	18192	281
FL AGOR HI GRID 300W	33483	263	GORDO N 1W CW-O-SR	18193	281
FL AGOR LED 100W NW	33470	262	GORI 50	29002	292
FL AGOR LED 150W NW	33471	262	GORI 80	29003	292
FL AGOR LED 200W NW	33472	262	GORI EL 135 D	29000	292
FL AGOR/A HI 240W NW	33477	263	GORI EL 235 D	29001	292
FL AGOR/A HI 300W NW	33479	263	GOVIK DSO-B A	29236	160
FL AGOR/A LED 100W	33473	262	GOVIK DSO-B/G	29232	160
FL AGOR/A LED 150W	33474	262	GOVIK DSO-W A	29235	160
FL AGOR/A LED 200W	33475	262	GOVIK DSO-W/G	29231	160
FL SOLNAR SLR 8W NW-B	36605	269	GOVIK-ST DSO-B	29237	160
FL SONE SLR L NW-GR	36607	268	GOVIK-ST DSO-B/G	29234	160
FL SONE SLR M NW-GR	36606	268	GOVIK-ST DSO-W	29238	160
FLINI IP44 DSL-B	33120	186	GOVIK-ST DSO-W/G	29233	160
FLINI IP44 DSL-W	33121	186	GRIBLO 7 GR	36432	300
FLINI IP44 DSO-B	33122	186	GRIP GP\S	4862	339
FLINI IP44 DSO-W	33123	186	GRIP W\US	4863	339
FLUXY LED IP44 B	37311	146	GRL 11M10E27-B	35754	301
FLUXY LED IP44 BL	37312	146	GRL 15M15E27-B	35758	301
FLUXY LED IP44 GN	37313	146	GRL 6M5E27-B	35750	301
FLUXY LED IP44 W	37310	146	GWEN CT-DTL50-B	18530	178
FLUXY LED IP44 Y	37314	146	GWEN CT-DTO50-B	18531	178
FOGLER DL-2400	18120	242	HANDLE B/F	26596	88
FOGLER LED 14W-NW	18121	242	HANDLE B/F	26596	91
FRANCO 15LED SMD KT-B	22341	155	HANDLE C/D/E/I	26597	89
FRANCO 15LED SMD KT-W	22340	155	HANDLE C/D/E/I	26597	90
FUTURIO LED	xxx	28	HANDLE G	26598	92
G9-20W STAR	18420	99	HANDLE H	26599	93
G9-33W STAR	18421	99	HANDLE J/K	26595	94
G9-48W STAR	18422	99	HANDLE J/K	26595	95
G9-60W STAR	18423	99	HANDLE SIDE H	26600	93
GALOBA EL-10 B	33671	130	HAXA-DSO POWER LED-B	8103	204
GALOBA EL-10 W	33670	130	HB PRO LED HI 100W-NW	27155	272
GALOBA EL-2I B	33675	130	HB PRO LED HI 150W-NW	27156	272
GALOBA EL-2I W	33674	130	HB PRO LED HI 200W-NW	27157	272
GALOBA EL-3I B	33677	130	HBPH GRID 100W	33196	273
GALOBA EL-3I W	33676	130	HBPH GRID 150W	33197	273
GALOBA EL-4I B	33681	130	HBPH GRID 200W	33198	273
GALOBA EL-4I W	33680	130	HBPH LENS 120D 100W	33193	273
GALOBA EL-4O B	33679	130	HBPH LENS 120D 150W	33194	273
GALOBA EL-4O W	33678	130	HBPH LENS 120D 200W	33195	273
GALOBA W 1xGU10 B	33673	143	HBPH LENS 50D 100W	33190	273
GALOBA W 1xGU10 W	33672	143	HBPH LENS 50D 150W	33191	273
GARTO LED EL 8W-GR	29270	275	HBPH LENS 50D 200W	33192	273
GARTO LED EL 8W-W	29271	275	HERMI 7063NB	70524	245
GAVI CT-2116B-C	811	205	HERON II LED B	27602	152
GAVI CT-2116B-C/M	815	205	HERON II LED W	27603	152
GAVI CT-2116B-W	810	205	HIERRO LED	xxx	26
GAVI LED18 SMD-WW-C/M	19761	205	HIMA LED 23W-NW-B	22842	248
GLASI LED 3W P NW-B	33694	279	HIMA LED 23W-NW-W	22841	248
GLASI LED 3W P NW-GR	33695	279	HIMA LED 33W-NW-B	22844	248
GLASI LED 3W P NW-W	33693	279	HIMA LED 33W-NW-W	22843	248
GLASI LED 3W P WW-B	33691	279	HILDR-E14	2170	341
GLASI LED 3W P WW-GR	33692	279	HILDR-E14-F	2173	341
GLASI LED 3W P WW-W	33690	279	HILDR-E27	2160	341
GLOZO DSL B/B	36215	157	HILDR-E27-D	2162	342
GLOZO DSL B/W	36211	157	HILDR-E27-F	2161	342
GLOZO DSL G/B	36216	157	HILDR-G9	8220	342
GLOZO DSL G/W	36212	157	HILDR-GX5,3	72109	343
GLOZO DSL SR/B	36217	157	HILDR-GZ10	402	343
GLOZO DSL SR/W	36213	157	HILDR-R7S	405	343
GLOZO DSL W/B	36214	157	HOFI LED WW W	37393	141
GLOZO DSL W/W	36210	157	HORN CTC-3114-GM/N	2824	181
GLOZO DSO B/B	36223	156	IDO 6,5W E14-NW	23438	59
GLOZO DSO B/W	36219	156	IDO 6,5W E14-WW	23439	59
GLOZO DSO G/B	36224	156	IMBER LED CW	23521	188
GLOZO DSO G/W	36220	156	IMBER LED NW	23520	188
			IMBER LED WW	23522	188

INDEKS ALFABETYCZNY

ALPHABETICAL INDEX

IMINES DSO-W	29031	165	IQ-LED G45E27 3,4W-CW	36693	60
INES 7061N	70525	246	IQ-LED G45E27 3,4W-NW	36692	60
INITA LED IP54 B	36321	147	IQ-LED G45E27 3,4W-WW	36691	60
INITA LED IP54 GN	36320	147	IQ-LED G45E27 5,9W-CW	36699	60
INITA LED IP54 R	36322	147	IQ-LED G45E27 5,9W-NW	36698	60
INITA LED IP54 W	36324	147	IQ-LED G45E27 5,9W-WW	36697	60
INITA LED IP54 Y	36323	147	IQ-LED GU 10 4,9W-CW	35258	65
INVO OP 107-L-GR	29173	294	IQ-LED GU 10 4,9W-NW	35257	65
INVO OP 47-L-GR	29171	294	IQ-LED GU 10 4,9W-WW	35256	65
INVO OP 77-L-GR	29172	294	IQ-LED GU10 6,5W-CW	35242	66
INVO OP EL-53-L-GR	29170	294	IQ-LED GU10 6,5W-NW	35241	66
INVO TR 107-O-GR	29177	295	IQ-LED GU10 6,5WS3-CW	35245	66
INVO TR 47-O-GR	29175	295	IQ-LED GU10 6,5WS3-NW	35244	66
INVO TR 77-O-GR	29176	295	IQ-LED GU10 6,5WS3-WW	35243	66
INVO TR EL-53-O-GR	29174	295	IQ-LED GU10 6,5W-WW	35240	66
IPER LED 10W-NW-L	37294	230	IQ-LED Life A60 7,2W-NW	33763	38
IPER LED 10W-NW-L-SE	37302	230	IQ-LED Life A60 7,2W-WW	33762	38
IPER LED 10W-NW-O	37290	230	IQ-LED Life G45 4,2W-NW	33761	38
IPER LED 10W-NW-O-SE	37298	230	IQ-LED Life G45 4,2W-WW	33760	38
IPER LED 19W-NW-L	37295	230	IQ-LED Life GU10 4,8W-NW	33765	38
IPER LED 19W-NW-L-SE	37303	230	IQ-LED Life GU10 4,8W-WW	33764	38
IPER LED 19W-NW-O	37291	230	IQ-LEDDIM A60 7,3W-NW	33723	42
IPER LED 19W-NW-O-SE	37299	230	IQ-LEDDIM A60 7,3W-WW	33722	42
IPER LED 26W-NW-L	37296	230	IQ-LEDDIM A6010,5W-NW	33725	42
IPER LED 26W-NW-L-SE	37304	230	IQ-LEDDIM A6010,5W-WW	33724	42
IPER LED 26W-NW-O	37292	230	IQ-LEDDIM A6013,6W-NW	33727	42
IPER LED 26W-NW-O-SE	37300	230	IQ-LEDDIM A6013,6W-WW	33726	42
IPER LED 35W-NW-L	37297	230	IQ-LEDDIM GU10 7W-CW	35248	67
IPER LED 35W-NW-L-SE	37305	230	IQ-LEDDIM GU10 7W-NW	35247	67
IPER LED 35W-NW-O	37293	230	IQ-LEDDIM GU10 7W-WW	35246	67
IPER LED 35W-NW-O-SE	37301	230	IQ-LEDEX GU 10 2,5W-NW	33769	65
IQ-LED A60 11W-CW	36681	40	IRS3xAAA LED PIR W-NW	37392	200
IQ-LED A60 11W-NW	36680	40	IT-1\20-RE	1273	351
IQ-LED A60 11W-WW	36679	40	IT-1\20-Y	1272	351
IQ-LED A60 3,4W-CW	36672	40	IT-1\20-Y\GN	1277	351
IQ-LED A60 3,4W-NW	36671	40	ITECH C1 302 STW	33823	346
IQ-LED A60 3,4W-WW	36670	40	ITECH C1 302MATW	33815	346
IQ-LED A60 5,9W-CW	36675	40	ITECH C2 105MATW	33834	346
IQ-LED A60 5,9W-NW	36674	40	ITECH F1 302MATW	33835	346
IQ-LED A60 5,9W-WW	36673	40	ITECH F2 105MATW	33836	346
IQ-LED A60 7,8W-CW	36678	40	ITECH F2 105MSTW	33824	346
IQ-LED A60 7,8W-NW	36677	40	ITECH M1 60 NM ST W	27769	346
IQ-LED A60 7,8W-WW	36676	40	ITECH M2 302MATW	33812	346
IQ-LED A67 N 19W-CW	33748	41	ITECH M2 302MSTW	33821	346
IQ-LED A67 N 19W-NW	33747	41	ITECH M5 105MATW	33832	346
IQ-LED A67 N 19W-WW	33746	41	ITECH M5 105MSTW	33822	346
IQ-LED AR-111 13W-NW	35253	72	ITECH M5 305MATW	33814	346
IQ-LED AR-111 13W-WW	35252	72	ITECH S1 302MATW	33833	346
IQ-LED C35E14 3,4W-NW	36683	56	ITECH W2 105MATW	33837	346
IQ-LED C35E14 3,4W-VW	36684	56	IVIAN LED 4,5W SN-NW	25783	253
IQ-LED C35E14 3,4W-WW	36682	56	IVIAN LED 4,5W SN-WW	25781	253
IQ-LED C35E14 5,9W-CW	36687	56	IVIAN LED 4,5W W-NW	25782	253
IQ-LED C35E14 5,9W-NW	36686	56	IVIAN LED 4,5W W-WW	25780	253
IQ-LED C35E14 5,9W-WW	36685	56	IVRI DTO-W	26736	175
IQ-LED ES-111 12W-NW	27319	72	J-1000W 189MM	10418	99
IQ-LED ES-111 12W-WW	27318	72	J-120W 118MM STAR	8500	100
IQ-LED EX T8 12W-CW	35255	73	J-120W 78MM STAR	8491	100
IQ-LED EX T8 12W-NW	35254	73	J-80W 78MM STAR	8490	100
IQ-LED FL QC I 3x1MM2	33889	264	JASMIN 270-B	29207	122
IQ-LED FL-10W-NW	33880	264	JASMIN 270-G/O	36440	122
IQ-LED FL-10W-NW-SE	33885	264	JASMIN 270-W	23123	122
IQ-LED FL-20W-NW	33881	264	JASMIN 270-W/M	23126	122
IQ-LED FL-20W-NW-SE	33886	264	JASMIN 270-WE	23120	122
IQ-LED FL-30W-NW	33882	264	JASMIN 370-B	29208	122
IQ-LED FL-30W-NW-SE	33887	264	JASMIN 370-G/O	36441	122
IQ-LED FL-50W-NW	33883	264	JASMIN 370-W	23124	122
IQ-LED FL-50W-NW-SE	33888	264	JASMIN 370-W/M	23127	122
IQ-LED FL-90W-NW	33884	264	JASMIN 370-WE	23121	122
IQ-LED G45E14 3,4W-CW	36690	60	JASMIN 470-B	29205	122
IQ-LED G45E14 3,4W-NW	36689	60	JASMIN 470-G/O	36442	122
IQ-LED G45E14 3,4W-WW	36688	60	JASMIN 470-W	23125	122
IQ-LED G45E14 5,9W-CW	36696	60	JASMIN 470-W/M	23128	122
IQ-LED G45E14 5,9W-NW	36695	60	JASMIN 470-WE	23122	122
IQ-LED G45E14 5,9W-WW	36694	60	JASMIN B-W	29209	121

JASMIN C 270-B	36505	105	LCOB 10W/M 12 IP00-NW	37231	83
JASMIN C 270-G/O	36499	105	LCOB 10W/M 12 IP00-WW	37230	83
JASMIN C 270-W/M	36502	105	LCOB 10W/M 12 IP65-NW	37233	83
JASMIN C 370-B	36506	105	LCOB 10W/M 12 IP65-WW	37232	83
JASMIN C 370-G/O	36500	105	LCOB 10W/M 24 IP00-NW	33368	84
JASMIN C 370-W/M	36503	105	LCOB 10W/M 24 IP65-NW	33369	84
JASMIN C 470-B	36507	105	LCOB 8W/M 12 IP00-NW	33366	83
JASMIN C 470-G/O	36501	105	LCOB 8W/M 12 IP00-WW	33364	83
JASMIN C 470-W/M	36504	105	LCOB 8W/M 12 IP65-NW	33367	83
JASMIN G/O-W	36443	121	LCOB 8W/M 12 IP65-WW	33365	83
JASMIN W/M-W	23758	121	LED12 G4-NW	18503	71
JASMIN WE-W	23756	121	LED12 G4-WW	18502	71
JASMIN W-W	23757	121	LEDS-B 4 8W/M IP00-CW	24518	79
JURBA DL-218L	8981	240	LEDS-B 4 8W/M IP00-NW	24517	79
JURBA DL-218O	8980	240	LEDS-B 4 8W/M IP00-WW	24516	79
JUSI E27 B	36271	151	LEDS-B 4 8W/M IP65-CW	24515	79
JUSI E27 W	36270	151	LEDS-B 4 8W/M IP65-NW	24514	79
K LED GU10 6W-CW	36332	67	LEDS-B 4 8W/M IP65-WW	24513	79
K LED GU10 6W-NW	36331	67	LEDS-B 7 2W/M IP00RGB	24530	85
K LED N GU10 6W-WW	36333	67	LEDS-B 7 2W/M IP54RGB	24532	85
KANTI V2LED 12W-NW-SN	27212	261	LEDS-B 7 2W/M IP65RGB	24531	85
KANTI V2LED 12W-NW-W	28950	261	LIEGO 37 B	36534	290
KANTI V2LED 18W-NW-SN	27213	261	LIEGO 89 PEND B	36531	290
KANTI V2LED 18W-NW-W	28951	261	LIEGO 97 B	36530	290
KATRO V2LED 12W-NW-SR	28939	258	LIEGO EL 28 UP B	36532	290
KATRO V2LED 12W-NW-W	28940	258	LIEGO EL 28 UP SE B	36533	290
KATRO V2LED 12W-WW-W	28941	258	LINUS LED 4W-NW	27590	204
KATRO V2LED 18W-NW-SR	28942	258	LINUS LED 7W-NW	27591	204
KATRO V2LED 18W-NW-W	28943	258	LINUS LINK	14977	204
KATRO V2LED 24W-NW-SN	27216	258	LUMKO LED 17,5W NW	37320	114
KATRO V2LED 24W-NW-W	28945	258	LUTO CTX-DS02B-AB	2584	179
KATRO V2LED 6W-NW-W	28946	258	LUTO CTX-DS02B-C/M	2583	179
LI20 16W/M 12 IP00CCT	33317	82	LUTO CTX-DS02B-W	2580	179
LI20 16W/M 24 IP00-NW	33312	81	LUTO CTX-DT02B-C	2591	179
LI20 16W/M 24 IP00-WW	33311	81	LUTO CTX-DT02B-W	2590	179
LI20 16W/M 24 IP65-NW	33315	81	MAH LED HI 19W-NW RYF	22606	222
LI20 16W/M 24 IP65-WW	33314	81	MAH LED HI 26W-NW RYF	22609	222
LI20B 16W/M 24IP00-NW	33356	81	MAH LED HI 38W-NW RYF	22607	222
LI20B 16W/M 24IP00-WW	33355	81	MAH LED HI 48W-NW RYF	22608	222
L48 9W/M 24 IP00-RGBW	33318	86	MAH PLUS-136/4LED/PC	22802	224
L48 9W/M 24 IP65-RGBW	33319	86	MAH PLUS-158/4LED/PC	22803	224
L60 11W/M 12 IP00-CW	33304	80	MAH PLUS-236/4LED/PC	22800	224
L60 11W/M 12 IP00-NW	33303	80	MAH PLUS-236-ABS/PC	18521	225
L60 11W/M 12 IP00-WW	33302	80	MAH PLUS-258/4LED/PC	22801	224
L60 11W/M 12 IP65-CW	33310	80	MAH-LED N 20W-NW/PC	22603	223
L60 11W/M 12 IP65-NW	33309	80	MAH-LED N 40W-NW/PC	22604	223
L60 11W/M 12 IP65-WW	33308	80	MAH-LED N 50W-NW/PC	22605	223
L60B 11W/M 12 IP00-CW	33307	80	MARC DL-60	7015	243
L60B 11W/M 12 IP00-NW	33306	80	MARID JQ-L	8910	328
L60B 11W/M 12 IP00-WW	33305	80	MARIN CT-S80-AB	4710	187
LARATA E27 B	36261	145	MARIN CT-S80-B	32501	187
LARATA E27 W	36260	145	MARIN CT-S80-C	4703	187
LARATA EL-10 B	36263	145	MARIN CT-S80-SN	4704	187
LARATA EL-10 W	36262	145	MARIN CT-S80-W	32500	187
LART EL-160-GR	29832	277	MATEO ES DLP-150-B	32930	253
LART EL-260-GR	29833	277	MATEO ES DLP-150-W	32931	253
LAURIN EL-10 B	29121	132	MATEO ES DLP-250-B	32932	253
LAURIN EL-10 W	29120	132	MATEO ES DLP-250-W	32933	253
LAURIN EL-21 B	29123	132	MEBA 4LED 120 IP54 PC	33895	226
LAURIN EL-21 W	29122	132	MEBA 4LED 150 IP54 PC	33896	226
LAURIN EL-31 B	29125	132	MEBA 4LED 2X120 OP PS	26964	227
LAURIN EL-31 W	29124	132	MEBA 4LED 2X120 PS	26961	227
LAURIN EL-30 B	29127	132	MEBA 4LED 2X150 OP PS	26965	227
LAURIN EL-30 W	29126	132	MEBA 4LED 60 IP54 PC	33894	226
LAURIN EL-40 B	29129	132	MEBA LED 12-20W NW/WW	33890	227
LAURIN EL-40 W	29128	132	MEBA LED 20W IP54 NW	33892	226
LAVEN 50 GR	36546	287	MEBA LED 22-40W NW/WW	33891	227
LAVEN 80 GR	36545	287	MEBA LED 40W IP54 NW	33893	226
LAVEN EL 25 GR	36548	287	MEFIS LED B-NW	32497	200
LAVEN EL 28 SE-GR	36547	287	MEFIS LED W-NW	32495	200
LCO B 10W/M 24 IP00-CW	33353	84	MERA LED 10W NW	29211	203
LCO B 10W/M 24 IP00-WW	33351	84	MERA LED 15W NW	29212	203
LCO B 10W/M 24 IP65-CW	33354	84	MERA LED 20W NW	29213	203
LCO B 10W/M 24 IP65-WW	33352	84	MERA LED 5W NW	29210	203

INDEKS ALFABETYCZNY
ALPHABETICAL INDEX

MERA LED PP	29214	203
MERGE ADJ-O	23451	331
MERGE JQ-L	7690	328
MERGE JQ-O	7691	330
MERGE MW-L	23453	331
MERGE-WT-O-W	37370	325
MILENO EL-10 ASR-AN	29111	138
MILENO EL-10 B-AG	29110	138
MILENO EL-2I ASR-AN	29115	138
MILENO EL-2I B-AG	29114	138
MILENO EL-3I ASR-AN	29117	138
MILENO EL-3I B-AG	29116	138
MILENO EL-3O ASR-AN	29113	138
MILENO EL-3O B-AG	29112	138
MILENO EL-4I ASR-AN	29119	138
MILENO EL-4I B-AG	29118	138
MILO 7040T	70522	245
MILO 7040T/P	70523	245
MILO 7040T/P-B	8092	245
MINI BORD DLP-50-B	28783	164
MINI BORD DLP-50-W	28782	164
MINI GORD DLP-50-B	28781	163
MINI GORD DLP-50-W	28780	163
MINI RITI GU10 B/B	27578	163
MINI RITI GU10 B/G	27575	163
MINI RITI GU10 B/W	27577	163
MINI RITI GU10 W/G	27576	163
MINI RITI GU10 W/W	27579	163
MODv2 LED 12W-NW	29301	78
MODv2 LED 12W-WW	29300	78
MODv2 LED 19W-NW	29303	78
MODv2 LED 19W-WW	29302	78
MORO N IG-20	18194	283
MORTA B CT-DSL50-B	22110	174
MORTA B CT-DSL50-SR	22112	174
MORTA B CT-DSO50-B	22116	174
MORTA B CT-DSO50-SR	22117	174
MORTA CT-DSL50-B	18510	173
MORTA CT-DSL50-SR	18512	173
MORTA CT-DSO50-B	19440	173
MORTA CT-DSO50-SR	19442	173
MORTA CT-DTL50-B	26719	173
MORTA CT-DTL50-SR	26718	173
MORTA CT-DTO50-B	26717	173
MORTA CT-DTO50-SR	26716	173
MORTA OCT-B	26715	174
MORTA OCT-SR	26714	174
NASTO 2SOC FR B	36586	302
NAVI CTX-DS10-B	25990	179
NAVI CTX-DT10-B	25991	179
NAVI CTX-DT10-C/M	2553	179
NAVI CTX-DT10-W	2550	179
NEDIA E14 B	34475	151
NEDIA E14 W	34476	151
NEON END CAP	37239	96
NEON END CAP HOLE	37238	96
NEON LED12W/M IP65-BL	37237	96
NEON LED12W/M IP65-CW	37236	96
NEON LED12W/M IP65-NW	37235	96
NEON LED12W/M IP65-WW	37234	96
NEON MOUNTING CLIP	37229	96
NESTA DSL-C	26747	177
NESTA DSL-C/M	26748	177
NESTA DTL-C	26751	177
NESTA DTL-C/M	26752	177
NOTUS 3 EVG 218 NT	19733	218
NOTUS 3 EVG 236 NT	19732	218
NOTUS 3 EVG 418 NT	19731	218
NOTUS 3WS EVG 236 NT	25712	218
NOTUS 3WS EVG 418 NT	25711	218
NOTUS 4LED 218 NT	22674	219
NOTUS 4LED 236 NT	22672	219
NOTUS 4LED 418 NT	22671	219

OFIS S LED	xxx	24
OGIVA D35 GR	27001	106
ONTEC C C160NMATW	33849	347
ONTEC C C160NMSTW	33868	347
ONTEC C M160NMATW	33847	347
ONTEC C M160NMSTW	33858	347
ONTEC G E1E 301 M STW	28976	347
ONTEC G E1E180MATW	28979	347
ONTEC R C1 60N M STW	33826	348
ONTEC R M1 60N M ATW	33850	348
ONTEC R M1 60N M STW	29098	348
ONTEC R M2 302 M ATW	33851	348
ONTEC R M2 302 M STW	33852	348
ONTEC S 20M1X AT W	27529	344
ONTEC S 20M1X ST W	27528	344
ONTEC S C1302MATW	33842	344
ONTEC S C1302MATWCLD	28977	344
ONTEC S C1302MSTW	33862	344
ONTEC S C160NMATW	28978	344
ONTEC S C2105MATW	33843	344
ONTEC S F2105MATW	33844	344
ONTEC S F2105MSTW	33864	344
ONTEC S M1180MATW	28973	344
ONTEC S M1180MSTW	27527	344
ONTEC S M2102MATWCLD	33819	344
ONTEC S M2302MATW	36382	344
ONTEC S M2302MATWCLD	33818	344
ONTEC S M2302MSTW	36381	344
ONTEC S M2302MSTWCLD	33856	344
ONTEC S M5105MATW	33840	344
ONTEC S M5105MSTW	33855	344
ONTEC S M5305MATW	33841	344
ONTEC S W1302MATW	33845	344
ONTEC S W1302MATWCLD	33810	344
ONTEC S W1302MSTW	33865	344
ONTEC S W1302MSTWCLD	33866	344
ONTEC S W2105MATWCLD	33846	344
ONTECSC1302MATW	27652	344
OPRAWA DWUSTRONNA OSO	33829	345
ORISA LED WW B	37395	141
ORISA LED WW W	37394	141
ORTE LED 18W-NW-O	29160	237
ORTE LED 18W-NW-O-SE	29162	237
ORTE LED 24W-NW-O	29161	237
ORTE LED 24W-NW-O-SE	29163	237
OYO 5LED-CW	8121	188
PEVO 50 GR	36551	286
PEVO 80 GR	36550	286
PEVO EL 25 GR	36552	286
PICTO ONTEC G D2	27483	349
PICTO ONTEC G D3	27484	349
PICTO ONTEC G D5	27482	349
PICTO ONTEC G D7	27488	349
PICTO ONTEC G D8	27485	349
PICTO ONTEC G DB	27499	349
PICTO ONTEC G DC	27500	349
PICTO ONTEC G F1	27497	349
PICTO ONTEC G F2	27498	349
PICTO ONTEC G W1	27490	349
PICTO ONTEC S D1	27509	350
PICTO ONTEC S D2	27506	350
PICTO ONTEC S D3	27507	350
PICTO ONTEC S D4	27512	350
PICTO ONTEC S D5	27505	350
PICTO ONTEC S D6	27510	350
PICTO ONTEC S D7	27511	350
PICTO ONTEC S D8	27508	350
PICTO ONTEC S DB	27522	350
PICTO ONTEC S DC	27523	350
PICTO ONTEC S F1	27520	350
PICTO ONTEC S W1	27513	350
PICTO ONTEC S W2	27514	350
PIN W\US	2186	339

PIRES DL-600	8810	241	REGIS 4LED OPAL 418PT	19736	217
PIRES DL-600 NS	8811	241	REKA LED EL 7W-L-GR	28990	274
PIRES ECO DL-250	19000	241	REKA LED EL 7W-L-W	28992	274
PIRES ECO DL-250 NS	19001	241	REKA LED EL 7W-O-GR	28991	274
PIXA KT-40-B	19301	152	REKA LED EL 7W-O-W	28993	274
PIXA KT-40-W	19300	152	REMI LED GU 10-CW	33082	69
PLAFMIN O	25690	244	REMI LED GU 10-NW	33080	69
POWELED P 12V 100W	28961	335	REMI LED GU 10-WW	33081	69
POWELED P 12V 150W	28963	335	REMOTE CCT	22145	87
POWELED P 12V 200W	28965	335	REMOTE MONO	22144	87
POWELED P 12V 30W	26810	335	REMOTE RGBW	22146	87
POWELED P 12V 60W	26811	335	REXAR LED B	33071	155
POWELED P 24V 100W	28962	335	REXAR LED W	33070	155
POWELED P 24V 150W	28964	335	RIFA LED 17,5W NW B/G	36464	118
POWELED P 24V 200W	28966	335	RIFA LED 17,5W NW B/W	36462	118
POWELED P 24V 30W	26815	335	RIFA LED 17,5W NW N1	36468	118
POWELED P 24V 60W	26816	335	RIFA LED 17,5W NW N2	35508	118
PREDA LED B	35780	154	RIFA LED 17,5W NW W/W	36460	118
PREDA LED W	35781	154	RIFA LED 17,5W WW B/G	36465	118
PRESO 30 GR	36542	288	RIFA LED 17,5W WW B/W	36463	118
PRESO 50 GR	36541	288	RIFA LED 17,5W WW N1	36469	118
PRESO 80 GR	36540	288	RIFA LED 17,5W WW N2	35509	118
PRESO EL 18 GR	36543	288	RIFA LED 17,5W WW W/W	36461	118
PROFILO B	19161	88	RIFA LED 17,5W WW W/W	36466	118
PROFILO B 2m	26540	88	RIFA LED 17,5W WW GR/G	36467	118
PROFILO C	19162	89	RIFA LED 17,5W WW GR/G	36467	118
PROFILO C 2m	26541	89	RITI GU10 B/B	27567	111
PROFILO D	19163	90	RITI GU10 B/G	27571	111
PROFILO D 2m	26542	90	RITI GU10 W/G	27570	111
PROFILO F	26552	91	RITI GU10 W/W	27569	111
PROFILO F 2m	26553	91	ROGER DL-2LED6	7281	281
PROFILO G	26558	92	ROGER DL-LED12	7280	281
PROFILO G 2m	26559	92	ROLF JQ-L	8820	329
PROFILO H	26560	93	ROLF JQ-O	8821	330
PROFILO H 2m	26561	93	ROLF MINI JQ-L	8822	329
PROFILO J	26544	94	ROLSO LED IP44 15W-NW	26700	189
PROFILO J 2M	26545	94	ROPE-NT 150	7870	218 / 219
PROFILO J-W	26546	94	ROPE-NT 150 SINGLE	7871	218 / 219
PROFILO J-W 2M	26547	94	ROUNDA V2LED12W-NW-SR	28930	256
PROFILO K	26548	95	ROUNDA V2LED12W-NW-W	28931	256
PROFILO K 2m	26549	95	ROUNDA V2LED12W-WW-W	28932	256
PROFILO K-W	26550	95	ROUNDA V2LED18W-NW-SR	28933	256
PROFILO K-W 2m	26551	95	ROUNDA V2LED18W-NW-W	28934	256
PSR 100	25591	213	ROUNDA V2LED18W-WW-W	28935	256
QULES AC O-B	26306	187	ROUNDA V2LED24W-NW-SN	27220	256
QULES AC O-C/M	26304	187	ROUNDA V2LED24W-NW-W	28936	256
QULES AC O-W	26303	187	ROUNDA V2LED24W-WW-W	33524	256
RADAN CT-DSO50	7362	181	ROUNDA V2LED6W-NW-SN	27221	256
RADAN CT-DTO50	7360	181	ROUNDA V2LED6W-NW-W	28937	256
RAIBO E27 B	36280	150	ROUNDA V2LED6W-WW-B	33562	256
RAIBO E27 BL	36282	150	ROUNDA V2LED6W-WW-W	28938	256
RAIBO E27 GN	36284	150	S A60 11,5WE27 RGB CCT	33642	36
RAIBO E27 PK	36285	150	S A60 7W E27 CCT	33640	36
RAIBO E27 W	36281	150	S A60 9W E27 RGB CCT	33641	36
RAIBO E27 Y	36283	150	S AD GN 10A PM	33701	318
RANGO MINI R7S SMD-WW	15099	77	S AD GN SCH 10A PM	33703	318
RANGO R7S SMD-WW	15098	77	S C37 4,9W E14 RGB CCT	33644	36
RAPID HI v2 E27-NW	22954	49	S GU10 4,7W RGB CCT	33643	36
RAPID HI v2 E27-WW	22955	49	S SENSOR ON\OFF INT	34942	316
RAPID MAXX v2 E27-NW	22948	49	S SENSOR PIR INT 10M	34940	316
RAPID MAXX v2 E27-WW	22949	49	S SENSOR W INT	34941	317
RAPID PRO v2 E27-NW	22946	49	S SWITCH G DOOR	34950	319
RAPID PRO v2 E27-WW	22947	49	S SWITCH ON\OFF	34948	319
RAPID v2 E27-NW	22944	49	S SWITCH SHUTTER	34949	319
RAPID v2 E27-WW	22945	49	SABIK LED AC-WW	23802	198
REF ATL1-18W-S15	33140	305	SABIK LED B-NW	29852	198
REF ATL1-18W-S36	33141	305	SABIK LED B-WW	29853	198
REF ATL1-30W-S15	33142	305	SABIK LED CW	23110	198
REF ATL1-30W-S36	33143	305	SABIK LED PIR B-NW	29858	198
REGIS 3 EVG 418 PT	19730	216	SABIK LED WW	23108	198
REGIS 3 OPAL 418 PT	19734	216	SABIK MINI LED B-NW	29854	198
REGIS 3WS EVG 418 PT	25710	216	SABIK MINI LED B-WW	29855	198
REGIS 3WS OPAL 418 PT	25713	216	SABIK MINI LED CW	23111	198
REGIS 4LED 418 PT	22673	217	SABIK MINI LED NW	32490	198
			SABIK MINI LED WW	23109	198

INDEKS ALFABETYCZNY

ALPHABETICAL INDEX

SANGA DL-100	8050	246	SHADE-U H-W 2m	26585	93
SANI IP44 DSO-B	29240	107	SIGO R39 LED E14-NW	22734	76
SANI IP44 DSO-SN	29242	107	SIGO R39 LED E14-WW	22733	76
SANI IP44 DSO-W	29241	107	SIGO R50 LED E14-NW	22736	76
SANSO LED 15W-NW-SE	26520	243	SIGO R50 LED E14-WW	22735	76
SEALINGS G	26602	92	SIGO R63 LED E27-NW	22738	76
SEIDY CT-DTL250-B/M	19459	166	SIGO R63 LED E27-WW	22737	76
SEIDY CT-DTL250-W/M	19455	166	SIMEN DSL B/G/B	29134	168
SEIDY CT-DTL50-AL	18281	166	SIMEN DSL B/W/B	29131	168
SEIDY CT-DTL50-B	18289	166	SIMEN DSL SR/B/B	29132	168
SEIDY CT-DTL50-B/M	19458	166	SIMEN DSL W/G/W	29135	168
SEIDY CT-DTL50-W/M	19454	166	SIMEN DSO B/G	29137	168
SEIDY CT-DTO50-AL	18280	166	SIMEN DSO B/W	29138	168
SEIDY CT-DTO50-B	18288	166	SIMEN DSO G/W	29142	168
SEIDY CT-DTO50-B/M	19457	166	SIMEN DSO W/B	29139	168
SEIDY CT-DTO50-W/M	19456	166	SIMEN DSO W/G	29140	168
SELTO 50 B	36556	289	SLICK JQ-L-B	8391	325
SELTO 80 B	36555	289	SLICK JQ-L-W	8390	325
SELTO EL 23 B	36557	289	SOLA LED AC-WW	23804	199
SEMPRA EL-II B-SR	33091	134	SOLA LED B-NW	27558	199
SEMPRA EL-II W-SR	33090	134	SOLA LED B-WW	27559	199
SEMPRA EL-2I B-SR	33093	134	SOLA LED NW	32491	199
SEMPRA EL-2I W-SR	33092	134	SOLA LED WW	23100	199
SEMPRA EL-3I B-SR	33095	134	SOLN LED 17,5W NW B/G	37324	116
SEMPRA EL-3I W-SR	33094	134	SONDA II EL-10 B	34920	128
SEMPRA EL-4I B-SR	33097	134	SONDA II EL-10 W	34921	128
SEMPRA EL-4I W-SR	33096	134	SONDA II EL-2I B	34922	128
SENSQUARE-B	37369	324	SONDA II EL-2I W	34923	128
SENSQUARE-W	37368	324	SONDA II EL-3I B	34924	128
SENTO	26820	332	SONDA II EL-3I W	34925	128
SENTO-O-WT-B	37367	324	SONDA II EL-30 B	34926	128
SENTO-O-WT-W	37366	324	SONDA II EL-30 W	34927	128
SENZO	26821	332	SONDA II EL-40 B	34928	128
SET105-K	1426	336	SONDA II EL-40 W	34929	128
SET60-K	1425	336	SONOR GU10 CO-B WW	24362	107
SHADE B/F-FR	26568	88	SOREN L-BL /LED	24414	171
SHADE B/F-FR	26568	91	SOREN L-SR CW /LED	24417	171
SHADE B/F-FR 2M	26570	88	SOREN L-SR WW /LED	24413	171
SHADE B/F-FR 2M	26570	91	SOREN O-BL /LED	24411	171
SHADE B/F-W	26569	88	SOREN O-SR CW /LED	24416	171
SHADE B/F-W	26569	91	SOREN O-SR WW /LED	24410	171
SHADE B/F-W 2M	26571	88	SPAG C B/G AWY	27324	162
SHADE B/F-W 2M	26571	91	SPAG D B/G AWY	27326	162
SHADE C/D/E/I-FR	26572	89	SPAG D W/G AWY	27327	162
SHADE C/D/E/I-FR	26572	90	SPAG S B/G AWY	27322	162
SHADE C/D/E/I-FR 2M	26573	89	SPN BRAVO S/P 12030	28505	213
SHADE C/D/E/I-FR 2M	26573	90	SPN BRAVO S/P 60-62	28504	213
SHADE C/D/E/I-W	26574	89	SPN PANEL 120	37336	209
SHADE C/D/E/I-W	26574	90	SPN PANEL 120	37336	211
SHADE C/D/E/I-W 2M	26575	89	SPN PANEL 60-62	37335	209
SHADE C/D/E/I-W 2M	26575	90	SPN PANEL 60-62	37335	211
SHADE CK C/D/E/I-FR	26576	89	SQMOTION-B	37361	322
SHADE CK C/D/E/I-FR	26576	90	SQMOTION-W	37360	322
SHADE CK C/D/E/I-FR2M	26577	89	ST 45 LED 0,5W E27-BL	26039	50
SHADE CK C/D/E/I-FR2M	26577	90	ST 45 LED 0,5W E27-GR	26048	50
SHADE CK C/D/E/I-W	26578	89	ST 45 LED 0,5W E27-NW	26046	50
SHADE CK C/D/E/I-W	26578	90	ST 45 LED 0,5W E27-RE	26049	50
SHADE CK C/D/E/I-W 2M	26579	89	ST 45 LED 0,5W E27-WW	26045	50
SHADE CK C/D/E/I-W 2M	26579	90	ST64 A 4W-SW	26047	51
SHADE CK G	26580	92	STAN GP	4864	339
SHADE CK G 2M	26581	92	STATO N LED 30W-B	29222	267
SHADE J/K-FR	26564	94	STATO N LED 50W-B	29223	267
SHADE J/K-FR	26564	95	STER TS-MF1	1001	334
SHADE J/K-FR 2m	26566	94	STIVI LED 24W-NW-O	35000	236
SHADE J/K-FR 2m	26566	95	STIVI LED 24W-NW-O-SE	35001	236
SHADE J/K-W	26565	94	STIVI LED 36W-NW-O	35002	236
SHADE J/K-W	26565	95	STIVI LED 36W-NW-O-SE	35003	236
SHADE J/K-W 2m	26567	94	STOBI DLP 250-B	26832	110
SHADE J/K-W 2m	26567	95	STOBI DLP 250-W	26833	110
SHADE-O H-W	26586	93	STOBI DLP 50-B	26830	110
SHADE-O H-W 2m	26587	93	STOBI DLP 50-W	26831	110
SHADE-U H-FR	26582	93	STONO 20 N	24654	296
SHADE-U H-FR 2m	26583	93	STONO 30	24651	296
SHADE-U H-W	26584	93	STONO 390 N	36591	296

STONO 490 N	36592	296	TEAR N CON-I FLEX W	33252	310
STONO 585 N	36593	296	TEAR N CON-I W	33240	310
STONO 780 N	36594	296	TEAR N CON-L LR-B	33245	310
STOPPER B	19181	88	TEAR N CON-L LR-W	33244	310
STOPPER C	19182	89	TEAR N CON-L RL-B	33243	310
STOPPER D	19183	90	TEAR N CON-L RL-W	33242	310
STOPPER F	26590	91	TEAR N CON-T LLR-B	33265	310
STOPPER G	26592	92	TEAR N CON-T LLR-W	33264	310
STOPPER J	26588	94	TEAR N CON-T LRR-B	33263	310
STOPPER J-W	26605	94	TEAR N CON-T LRR-W	33262	310
STOPPER K	26589	95	TEAR N CON-T RLL-B	33251	310
STOPPER K-W	26606	95	TEAR N CON-T RLL-W	33250	310
STOPPER-O H	26594	93	TEAR N CON-T RRL-B	33249	310
STOPPER-U H	26593	93	TEAR N CON-T RRL-W	33248	310
STRETON LED 100W NW	36231	270	TEAR N CON-X B	33247	310
STRETON LED 150W NW	36232	270	TEAR N CON-X W	33246	311
STRETON LED 200W NW	36233	270	TEAR N EPLUG B	33237	311
STRETON LED 20W NW	36228	270	TEAR N EPLUG W	33236	311
STRETON LED 40W NW	36229	270	TEAR N ICON-I B	33239	311
STRETON LED 60W NW	36230	270	TEAR N ICON-I W	33238	311
SUZI HR-60-B	7151	153	TEAR N PADAPTOR-B	33267	313
SUZI HR-60-BL	7152	153	TEAR N PADAPTOR-W	33266	313
SUZI HR-60-PK	7153	153	TEAR N PCON L-B	33261	311
SUZI HR-60-SR	7150	153	TEAR N PCON L-W	33260	311
SUZI HR-60-W	7154	153	TEAR N PCON R-B	33235	311
T-1\10-B	1257	351	TEAR N PCON R-W	33234	311
T-1\20-B	1271	351	TEAR N RC-CON-I B	35795	311
T-1\20-BL	1275	351	TEAR N RC-CON-I W	35794	311
T-1\20-GN	1274	351	TEAR N RC-CON-L B	35793	312
T-1\20-MIX	1283	351	TEAR N RC-CON-L W	35792	311
T-1\20-W	1276	351	TEAR N RC-CON-T B	35797	312
T5-13W 4000K/65	12716	100	TEAR N RC-CON-T W	35796	312
T5-14W 4000K/82	12717	100	TEAR N RC-CON-X B	35799	312
T5-8W 4000K/65	12715	100	TEAR N RC-CON-X W	35798	312
T8 18W/840 NW	19921	101	TEAR N RCLIP-B	35803	312
T8 18W/865 CW	19922	101	TEAR N RCLIP-W	35802	312
T8 36W/840 NW	19924	101	TEAR N RC-PCON B	35791	311
T8 36W/865 CW	19925	101	TEAR N RC-PCON W	35790	311
T8 LED GLASSv3 18W-CW	26065	74	TEAR N R-TR 2M-B	35801	311
T8 LED GLASSv3 18W-NW	26064	74	TEAR N R-TR 2M-W	35800	311
T8 LED GLASSv3 22W-CW	26059	74	TEAR N SCLAMP B	33255	311
T8 LED GLASSv3 22W-NW	26058	74	TEAR N SCLAMP W	33254	311
T8 LED GLASSv3 9W-CW	26063	74	TEAR N SKIT B	33257	311
T8 LED GLASSv3 9W-NW	26062	74	TEAR N SKIT W	33256	311
T8 LED GLASSv4 18W-CW	33213	75	TEAR N TR 1M-B	33231	311
T8 LED GLASSv4 18W-NW	33212	75	TEAR N TR 1M-W	33230	311
T8 LED GLASSv4 24W-CW	33215	75	TEAR N TR 2M-B	33233	311
T8 LED GLASSv4 24W-NW	33214	75	TEAR N TR 2M-W	33232	311
T8 LED GLASSv4 9W-CW	33211	75	TEDI MAXX LED GU 10-CW	23413	69
T8 LED GLASSv4 9W-NW	33210	75	TEDI MAXX LED GU 10-NW	23414	69
T8 LED GLASSv5 12W-CW	33217	75	TEDI MAXX LED GU 10-WW	23412	69
T8 LED GLASSv5 12W-NW	33216	75	TERRA LED AC-WW	23806	197
T8 LED STARTER	26069	74	TERRA LED B-NW	26848	197
T8LED GLASSv3T 18W NW	26068	74	TERRA LED B-WW	26849	197
TANO G4 SMD-NW	14937	71	TERRA LED CW	23104	197
TANO G4 SMD-WW	14936	71	TERRA LED PIR B-NW	29860	197
TAVO FRAME DL 12W	36522	254	TERRA LED PIR B-WW	29861	197
TAVO FRAME DL 18W	36523	254	TERRA LED W-CW	26843	197
TAVO FRAME DO 12W	36520	254	TERRA LED WW	23102	197
TAVO FRAME DO 18W	36521	254	TERRA LED W-WW	26842	197
TAVO LED DL 12W-NW	36517	254	TESON AL-DSL50	7373	181
TAVO LED DL 18W-NW	36518	254	TESON AL-DSO50	7372	181
TAVO LED DL 24W-NW	36519	254	TESON AL-DTL50	7371	181
TAVO LED DL 5W-NW	36515	254	TIBERI PRO 20W-940-B	35671	250
TAVO LED DL 9W-NW	36516	254	TIBERI PRO 20W-940-W	35670	250
TAVO LED DO 12W-NW	36512	254	TIBERI PRO 30W-940-B	35673	250
TAVO LED DO 18W-NW	36513	254	TIBERI PRO 30W-940-W	35672	250
TAVO LED DO 24W-NW	36514	254	TIBERI PRO 40W-940-B	35675	250
TAVO LED DO 5W-NW	36510	254	TIBERI PRO 40W-940-W	35674	250
TAVO LED DO 9W-NW	36511	254	TIBERI PRO NT20W-940B	35677	251
TAXI SMD L C/M-NW	26461	279	TIBERI PRO NT20W-940W	35676	251
TAXI SMD P C/M-NW	26463	279	TIBERI PRO NT30W-940B	35679	251
TEAR N CON-I B	33241	310	TIBERI PRO NT30W-940W	35678	251
TEAR N CON-I FLEX B	33253	310	TINY BORD DTO-B	37165	164

INDEKS ALFABETYCZNY

ALPHABETICAL INDEX

TINY BORD DTO-B/G	37166	164	VARSO LED 24W-NW-L-SE	26983	234
TINY BORD DTO-W	37167	164	VARSO LED 24W-NW-O	26445	234
TINY BORD DTO-W/G	37168	164	VARSO LED 24W-NW-O-SE	26984	234
TOMI LED5W MR16-CW	22705	76	VARSO LED 24W-WW-O	26444	234
TOMI LED5W MR16-WW	22704	76	VIDI CTC-5514-B	25995	180
TOMI LED7W MR16-CW	22707	76	VIDI CTC-5514-C	2791	180
TOMI LED7W MR16-WW	22706	76	VIDI CTC-5514-C/M	2793	180
TOMIv2 1,2W GU10-CW	34960	68	VIDI CTC-5514-W	2790	180
TOMIv2 1,2W GU10-NW	34961	68	VIDI CTC-5515-B	25996	180
TOMIv2 1,2W GU10-WW	34962	68	VIDI CTC-5515-C	2781	180
TOMIv2 2,9W GU10-CW	34963	68	VIDI CTC-5515-C/M	2783	180
TOMIv2 2,9W GU10-NW	34964	68	VIDI CTC-5515-W	2780	180
TOMIv2 2,9W GU10-WW	34965	68	VIMO 50 B	34984	291
TOMIv2 4,9W GU10-CW	34966	68	VIMO 50 BR	34985	291
TOMIv2 4,9W GU10-NW	34967	68	VIMO 50 SE-B	34986	291
TOMIv2 4,9W GU10-WW	34968	68	VIMO 50 SE-BR	34987	291
TOMIv2 6,5W GU10-CW	34969	68	VIMO 80 B	34988	291
TOMIv2 6,5W GU10-NW	34970	68	VIMO 80 BR	34989	291
TOMIv2 6,5W GU10-WW	34971	68	VIMO EL 27 B	34980	291
TONIL LED B	32520	143	VIMO EL 27 BR	34981	291
TONIL LED W	32521	143	VIMO EL 27 SE-B	34982	291
TP SLIM LED 40W-NW	27115	221	VIMO EL 27 SE-BR	34983	291
TP SLIM LED 50W-NW	27116	221	VORA EL 20 GR	36566	299
TP SLIM TW LED 40W-NW	27117	221	VORA SP 20 GR	36565	299
TP SLIM TW LED 50W-NW	27118	221	WIR ZL100	70961	337
TP STRONG LED 48W-NW	33170	220	WIR ZL120	70962	337
TP STRONG LED 75W-NW	33171	220	XARD DL-40	7195	283
TP STRONG LED 90W-NW ()	33172	220	XLED A60 10W-NW	29606	44
TRIBIS II L AB	23843	184	XLED A60 10W-NW-M	29616	46
TRIBIS II L B	23853	184	XLED A60 10W-WW	29605	44
TRIBIS II L C	23844	184	XLED A60 10W-WW-M	29615	46
TRIBIS II L C/M	23845	184	XLED A60 4,5W-NW-M	29608	46
TRIBIS II L W	23849	184	XLED A60 4,5W-WW	29600	44
TRIBIS II O AB	23846	184	XLED A60 4,5W-WW-M	29607	46
TRIBIS II O B	23855	184	XLED A60 4W-SW	33516	54
TRIBIS II O C	23847	184	XLED A60 7W-CW	29603	44
TRIBIS II O C/M	23848	184	XLED A60 7W-NW	29602	44
TRIBIS II O W	23854	184	XLED A60 7W-NW-M	29610	46
TUNA MINI N	8091	247	XLED A60 7W-WW	29601	44
TUNA S1101-W	4260	247	XLED A60 7W-WW-M	29609	46
TURK DL-60	7025	247	XLED A60 8W-NW-M	29613	46
TURRO LED 3X15W-NW	18983	280	XLED A60 8W-WW	29604	44
TWISTER AOL100B	70926	337	XLED A60 8W-WW-M	29612	46
TWISTER AOL100T	70953	337	XLED A60 B22 10W-CW-M	33109	48
TWISTER AOL120B	70956	337	XLED A60 B22 10W-WW-M	33108	48
TWISTER AOL120T	70960	337	XLED A60 B22 7W-CW-M	33103	48
TYBIA LED 38W-NW	24640	239	XLED A60 B22 7W-WW	33100	48
TYBIA LED 38W-NW B	24642	239	XLED A60 B22 7W-WW-M	33102	48
TYBIA LED 38W-NW-SE	24641	239	XLED A60 M 7W-NW	33515	52
TYBIA LED 38W-NW-SE B	24643	239	XLED A60 M 7W-WW	33514	52
TYBIA M 25W-NW B	24645	239	XLED A70 18W-NW	29649	45
TYBIA M 25W-NW GY	24644	239	XLED A70 18W-WW	29648	45
TYBIA M 25W-NW-SE B	24647	239	XLED C35 E14 6W-NW	35273	58
TYBIA M 25W-NW-SE GY	24646	239	XLED C35 E14 6W-WW	35272	58
UCHW PODT OS S2 S3 IT	33830	345	XLED C35E14 2,5W-WW	29617	58
ULOV LED DIM WW W	37396	140	XLED C35E14 4,5W-NW	29619	58
USTI SP 1X7 GR	36561	298	XLED C35E14 4,5W-NW-M	29621	58
USTI SP 2X7 GR	36560	298	XLED C35E14 4,5W-WW	29618	58
VADRA 16L-UP	29010	293	XLED C35E14 4,5W-WW-M	29620	58
VADRA 21L-UP SE	29011	293	XLED C35E14 6W-NW-M	29623	58
VADRA 50	29012	293	XLED C35E14 6W-WW-M	29622	58
VADRA 80	29013	293	XLED C35E27 6W-NW-M	29647	58
VAND LED 17,5W NW B	37327	117	XLED C35E27 6W-WW-M	29646	58
VAND LED 17,5W NW W	37326	117	XLED C35T 2,5W-SW	29641	54
VARSO HI 36W-NW-L	26449	234	XLED EX A60 4W-NW	36244	43
VARSO HI 36W-NW-O	26448	234	XLED EX A60 4W-WW	36243	43
VARSO HI 36W-NW-O-SE	26985	234	XLED EX A60 5W-NW	36246	43
VARSO LED 18W-NW-L	26443	234	XLED EX A60 5W-WW	36245	43
VARSO LED 18W-NW-L-SE	26980	234	XLED EX A60 7,2W-NW	36248	43
VARSO LED 18W-NW-O	26441	234	XLED EX A60 7,2W-WW	36247	43
VARSO LED 18W-NW-O-SE	26981	234	XLED G125 11W-NW	33512	53
VARSO LED 18W-WW-O	26440	234	XLED G125 11W-WW	33511	53
VARSO LED 24W-NW-L	26447	234	XLED G125 4W-SW	33519	54

XLED G125 7W-WW	29638	53
XLED G45 E14 4,5W-WW	29624	62
XLED G45 E14 6W-NW	35277	62
XLED G45 E14 6W-NW-M	29629	63
XLED G45 E14 6W-WW	35276	62
XLED G45 E14 6W-WW-M	29628	63
XLED G45 E27 4,5W-WW	29625	62
XLED G45 E27 6W-NW	35275	62
XLED G45 E27 6W-NW-M	29633	63
XLED G45 E27 6W-WW	35274	62
XLED G45 E27 6W-WW-M	29632	63
XLED G45E14 4,5W-NW-M	29627	63
XLED G45E14 4,5W-WW-M	29626	63
XLED G45E27 4,5W-NW-M	29631	63
XLED G45E27 4,5W-WW-M	29630	63
XLED G95 4W-SW	33518	54
XLED G95 7W-WW	36241	52
XLED G95S 5,8W-NW	36242	52
XLED HP D46E40 38W-NW	37347	98
XLED HP D90E27 26W-NW	37346	98
XLED ST64 4W-SW	33517	54
XLED ST64 7W-WW	29637	51
XLED ST64C 7W-NW	33513	51
XLED W A60 8,5W-WW	37380	55
XLED W C35E14 4,5W-WW	37382	55
XLED W G45E14 4,5W-WW	37383	55
XLED W ST 64 7W-WW	37381	55
XLEDA60 7W-NW-STEPPDIM	29635	47
XLEDA60 7W-WW-STEPPDIM	29634	47
XLEDEX C35E14 3,8W-NW	37341	57
XLEDEX C35E14 3,8W-WW	37340	57
XLEDEX G45E14 3,8W-NW	37343	61
XLEDEX G45E14 3,8W-WW	37342	61
XLEDEX G45E27 3,8W-NW	37345	61
XLEDEX G45E27 3,8W-WW	37344	61
XLEDI M A60 B22 12W-CW	37244	48
XLEDI M A60 B22 12W-WW	37243	48
XLEDI M A60 E27 11W-CW	37242	47
XLEDI M A60 E27 11W-NW	37241	47
XLEDI M A60 E27 11W-WW	37240	47
XLEDIM C35E14 5,9W-WW	35278	57
ZARA HR-40-B	7561	153
ZARA HR-40-SR	7560	153
ZARA HR-40-W	7564	153
ZARK KRT \2-1	2180	340
ZARK KRW -3	2181	340
ZEPO LFD-T02/S-B	36632	202
ZEPO LFD-T02/S-C/M	4386	202
ZEPO LFD-T02/S-W	36633	202
ZEPO LFD-T02-B	36630	202
ZEPO LFD-T02-C/M	4381	202
ZEPO LFD-T02-W	36631	202
ZEST MON OS010 W	28974	345
ZEST MONT OS05	33871	345
ZEST MONT OS205	33877	345
ZEST MONT S20 FLAGA	33876	345
ZEST POD OR00 B	28985	345
ZEW EL-235J-B	22440	276
ZEW EL-235J-GR	22442	276
ZEW EL-235U-B	22441	276
ZEW EL-235U-GR	22443	276
ZONA FLAT-W	23452	327
ZONA JQ-37-B	463	327
ZONA JQ-37-W	464	327
ZONA MINI WT-W	37365	323
ZONA MINI-W	37364	323
ZUBI LED 4W E14-NW	24529	70
ZUBI LED 4W E14-WW	24528	70
ZUBI LED 4W G9-CW	24519	70
ZUBI LED 4W G9-NW	24527	70
ZUBI LED 4W G9-WW	24526	70

INDEKS WEDŁUG KODÓW

INDEX BY CODES

276	BERGAD-7L	282	7691	MERGEJQ-O	330
402	HLDR-G210	343	7870	ROPE-NT 150	218
405	HLDR-R7S	343	7870	ROPE-NT 150	219
460	ALERJQ-30-W	326	7871	ROPE-NT 150 SINGLE	218
461	ALERJQ-30-B	326	7871	ROPE-NT 150 SINGLE	219
463	ZONAJQ-37-B	327	7980	APO TM -3	340
464	ZONAJQ-37-W	327	8050	SANGA DL-100	246
810	GAVI CT-2116B-W	205	8091	TUNA MINI N	247
811	GAVI CT-2116B-C	205	8092	MILO 7040T/P-B	245
815	GAVI CT-2116B-C/M	205	8103	HAXA-DSO POWER LED-B	204
1001	STER TS-MF1	334	8121	OYO 5LED-CW	188
1016	CYBER TM -6	334	8220	HLDR-G9	342
1257	T-1\10-B	351	8390	SLICK JQ-L-W	325
1271	T-1\20-B	351	8391	SLICK JQ-L-B	325
1272	IT-1\20-Y	351	8490	J-80W 78MM STAR	100
1273	IT-1\20-RE	351	8491	J-120W 78MM STAR	100
1274	T-1\20-GN	351	8500	J-120W 118MM STAR	100
1275	T-1\20-BL	351	8810	PIRES DL-600	241
1276	T-1\20-W	351	8811	PIRES DL-600 NS	241
1277	IT-1\20-Y\GN	351	8820	ROLF JQ-L	329
1283	T-1\20-MIX	351	8821	ROLF JQ-O	330
1425	SET60-K	336	8822	ROLF MINI JQ-L	329
1426	SET105-K	336	8910	MARID JQ-L	328
1440	ADI 350 1x3W	335	8980	JURBA DL-2180	240
2160	HLDR-E27	341	8981	JURBA DL-218L	240
2161	HLDR-E27-F	342	10418	J-1000W 189MM	99
2162	HLDR-E27-D	342	12715	TS-8W 4000K/65	100
2170	HLDR-E14	341	12716	TS-13W 4000K/65	100
2173	HLDR-E14-F	341	12717	TS-14W 4000K/82	100
2180	ZARK KRT \2-1	340	14936	TANO G4 SMD-WW	71
2181	ZARK KRW -3	340	14937	TANO G4 SMD-NW	71
2186	PIN W\US	339	14977	LINUS LINK	204
2550	NAVI CTX-DT10-W	179	15098	RANGO R7S SMD-WW	77
2553	NAVI CTX-DT10-C/M	179	15099	RANGO MINI R7S SMD-WW	77
2580	LUTO CTX-DS02B-W	179	18120	FOGLER DL-2400	242
2583	LUTO CTX-DS02B-C/M	179	18121	FOGLER LED 14W-NW	242
2584	LUTO CTX-DS02B-AB	179	18192	GORDO N 1W CW-L-SR	281
2590	LUTO CTX-DT02B-W	179	18193	GORDO N 1W CW-O-SR	281
2591	LUTO CTX-DT02B-C	179	18194	MORO N IG-20	283
2780	VIDI CTC-5515-W	180	18280	SEIDY CT-DT050-AL	166
2781	VIDI CTC-5515-C	180	18281	SEIDY CT-DTL50-AL	166
2783	VIDI CTC-5515-C/M	180	18288	SEIDY CT-DT050-B	166
2790	VIDI CTC-5514-W	180	18289	SEIDY CT-DTL50-B	166
2791	VIDI CTC-5514-C	180	18420	G9-20W STAR	99
2793	VIDI CTC-5514-C/M	180	18421	G9-33W STAR	99
2824	HORN CTC-3114-GM/N	181	18422	G9-48W STAR	99
4260	TUNA S1101-W	247	18423	G9-60W STAR	99
4381	ZEPO LFD-T02-C/M	202	18502	LED12 G4-WW	71
4386	ZEPO LFD-T02/S-C/M	202	18503	LED12 G4-NW	71
4703	MARIN CT-S80-C	187	18510	MORTA CT-DSL50-B	173
4704	MARIN CT-S80-SN	187	18512	MORTA CT-DSL50-SR	173
4710	MARIN CT-S80-AB	187	18521	MAH PLUS-236-ABS/PC	225
4862	GRIP GP\S	339	18530	GWEN CT-DTL50-B	178
4863	GRIP W\US	339	18531	GWEN CT-DT050-B	178
4864	STAN GP	339	18560	EVIT CT-DTL50-AL	178
7015	MARC DL-60	243	18561	EVIT CT-DT050-AL	178
7025	TURK DL-60	247	18593	CL-MAH PLUS	225
7080	BART EL-235	277	18594	CL-MAH PLUS-INOX	225
7150	SUZI HR-60-SR	153	18983	TURRO LED 3X15W-NW	280
7151	SUZI HR-60-B	153	19000	PIRES ECO DL-250	241
7152	SUZI HR-60-BL	153	19001	PIRES ECO DL-250 NS	241
7153	SUZI HR-60-PK	153	19030	CONNECTOR 8	79
7154	SUZI HR-60-W	153	19032	CONNECTOR 8-CP	79
7172	BERG DL-100	282	19033	CONNECTOR 8-CPC	79
7173	BERG DL-10L	282	19036	CONNECTOR RGB 10-CP	85
7195	XARD DL-40	283	19037	CONNECTOR RGB 10-CPC	85
7280	ROGER DL-LED12	281	19038	CONNECTOR RGB 10	85
7281	ROGER DL-2LED6	281	19062	DABA N LED SMD DL-16W	238
7360	RADAN CT-DT050	181	19065	DABA PRO 25W NW-B	238
7362	RADAN CT-DS050	181	19066	DABA PRO 26W NW-SE-W	238
7371	TESON AL-DTL50	181	19161	PROFILO B	88
7372	TESON AL-DS050	181	19162	PROFILO C	89
7373	TESON AL-DSL50	181	19163	PROFILO D	90
7560	ZARA HR-40-SR	153	19181	STOPPER B	88
7561	ZARA HR-40-B	153	19182	STOPPER C	89
7564	ZARA HR-40-W	153	19183	STOPPER D	90
7690	MERGEJQ-L	328	19300	PIXA KT-40-W	152

19301	PIXA KT-40-B	152	22946	RAPID PRO v2 E27-NW	49
19440	MORTA CT-DSO50-B	173	22947	RAPID PRO v2 E27-WW	49
19442	MORTA CT-DSO50-SR	173	22948	RAPID MAXX v2 E27-NW	49
19454	SEIDY CT-DTL50-W/M	166	22949	RAPID MAXX v2 E27-WW	49
19455	SEIDY CT-DTL250-W/M	166	22954	RAPID HI v2 E27-NW	49
19456	SEIDY CT-DTO50-W/M	166	22955	RAPID HI v2 E27-WW	49
19457	SEIDY CT-DTO50-B/M	166	23100	SOLA LED WW	199
19458	SEIDY CT-DTL50-B/M	166	23102	TERRA LED WW	197
19459	SEIDY CT-DTL250-B/M	166	23104	TERRA LED CW	197
19730	REGIS 3 EVG 418 PT	216	23106	APUS LED WW	196
19731	NOTUS 3 EVG 418 NT	218	23107	APUS LED CW	196
19732	NOTUS 3 EVG 236 NT	218	23108	SABIK LED WW	198
19733	NOTUS 3 EVG 218 NT	218	23109	SABIK MINI LED WW	198
19734	REGIS 3 OPAL 418 PT	216	23110	SABIK LED CW	198
19736	REGIS 4LED OPAL 418PT	217	23111	SABIK MINI LED CW	198
19761	GAVI LED18 SMD-WW-C/M	205	23120	JASMIN 270-WE	122
19921	T8 18W/840 NW	101	23121	JASMIN 370-WE	122
19922	T8 18W/865 CW	101	23122	JASMIN 470-WE	122
19924	T8 36W/840 NW	101	23123	JASMIN 270-W	122
19925	T8 36W/865 CW	101	23124	JASMIN 370-W	122
22110	MORTA B CT-DSL50-B	174	23125	JASMIN 470-W	122
22112	MORTA B CT-DSL50-SR	174	23126	JASMIN 270-W/M	122
22116	MORTA B CT-DSO50-B	174	23127	JASMIN 370-W/M	122
22117	MORTA B CT-DSO50-SR	174	23128	JASMIN 470-W/M	122
22140	CONTROLLER LED RGB-RF	85	23412	TEDI MAXX LED GU 10-WW	69
22144	REMOTE MONO	87	23413	TEDI MAXX LED GU 10-CW	69
22145	REMOTE CCT	87	23414	TEDI MAXX LED GU 10-NW	69
22146	REMOTE RGBW	87	23418	BILO 4,9W E27-NW	64
22147	CTR L 12/24V MONO/CTT	87	23419	BILO 4,9W E27-WW	64
22148	CTR L 12/24V RG BW CTT	87	23428	BILO 4,9W E14-NW	64
22340	FRANCO 15LED SMD KT-W	155	23429	BILO 4,9W E14-WW	64
22341	FRANCO 15LED SMD KT-B	155	23434	DUN 4,9W E14-WW	59
22371	AZ-10A	333	23435	DUN 4,9W E14-NW	59
22422	ESG LED 9W GX53-WW	77	23436	DUN 6,5W E14-NW	59
22423	ESG LED 9W GX53-NW	77	23437	DUN 6,5W E14-WW	59
22424	ESG LED 9W GX53-CW	77	23438	IDO 6,5W E14-NW	59
22430	DALLA CT-DTO50-W	171	23439	IDO 6,5W E14-WW	59
22431	DALLA CT-DTL50-W	171	23450	ALER MINI-W	326
22432	DALLA CT-DTO50-B	171	23451	MERGE ADJ-O	331
22433	DALLA CT-DTL50-B	171	23452	ZONA FLAT-W	327
22440	ZEW EL-235J-B	276	23453	MERGE MW-L	331
22441	ZEW EL-235U-B	276	23520	IMBER LED NW	188
22442	ZEW EL-235J-GR	276	23521	IMBER LED CW	188
22443	ZEW EL-235U-GR	276	23522	IMBER LED WW	188
22551	BORD DLP-50-W	111	23756	JASMIN WE-W	121
22552	BORD DLP-50-B	111	23757	JASMIN W-W	121
22603	MAH-LED N 20W-NW/PC	223	23758	JASMIN W/M-W	121
22604	MAH-LED N 40W-NW/PC	223	23800	APUS LED AC-WW	196
22605	MAH-LED N 50W-NW/PC	223	23801	APUS LED AC-CW	196
22606	MAH LED HI 19W-NW RYF	222	23802	SABIK LED AC-WW	198
22607	MAH LED HI 38W-NW RYF	222	23804	SOLA LED AC-WW	199
22608	MAH LED HI 48W-NW RYF	222	23806	TERRA LED AC-WW	197
22609	MAH LED HI 26W-NW RYF	222	23843	TRIBIS II LAB	184
22671	NOTUS 4LED 418 NT	219	23844	TRIBIS II L C	184
22672	NOTUS 4LED 236 NT	219	23845	TRIBIS II L C/M	184
22673	REGIS 4LED 418 PT	217	23846	TRIBIS II O AB	184
22674	NOTUS 4LED 218 NT	219	23847	TRIBIS II O C	184
22704	TOMI LED5W MR16-WW	76	23848	TRIBIS II O C/M	184
22705	TOMI LED5W MR16-CW	76	23849	TRIBIS II L W	184
22706	TOMI LED7W MR16-WW	76	23853	TRIBIS II L B	184
22707	TOMI LED7W MR16-CW	76	23854	TRIBIS II O W	184
22733	SIGO R39 LED E14-WW	76	23855	TRIBIS II O B	184
22734	SIGO R39 LED E14-NW	76	23860	DRIVE LED 0-15W 12VDC	336
22735	SIGO R50 LED E14-WW	76	24240	CIRCO LED 12VDC 0-10W	336
22736	SIGO R50 LED E14-NW	76	24241	CIRCO LED 12VDC 0-15W	336
22737	SIGO R63 LED E27-WW	76	24362	SONOR GU10 CO-B WW	107
22738	SIGO R63 LED E27-NW	76	24410	SOREN O-SR WW /LED	171
22800	MAH PLUS-236/4LED/PC	224	24411	SOREN O-BL /LED	171
22801	MAH PLUS-258/4LED/PC	224	24413	SOREN L-SR WW /LED	171
22802	MAH PLUS-136/4LED/PC	224	24414	SOREN L-BL /LED	171
22803	MAH PLUS-158/4LED/PC	224	24416	SOREN O-SR CW /LED	171
22841	HIMA LED 23W-NW-W	248	24417	SOREN L-SR CW /LED	171
22842	HIMA LED 23W-NW-B	248	24513	LEDS-B 4 8W/M IP65-WW	79
22843	HIMA LED 33W-NW-W	248	24514	LEDS-B 4 8W/M IP65-NW	79
22844	HIMA LED 33W-NW-B	248	24515	LEDS-B 4 8W/M IP65-CW	79
22944	RAPID v2 E27-NW	49	24516	LEDS-B 4 8W/M IP00-WW	79
22945	RAPID v2 E27-WW	49	24517	LEDS-B 4 8W/M IP00-NW	79

INDEKS WEDŁUG KODÓW

INDEX BY CODES

24518	LEDS-B 4 8W/M IP00-CW	79	26540	PROFILO B 2m	88
24519	ZUBI LED 4W G9-CW	70	26541	PROFILO C 2m	89
24526	ZUBI LED 4W G9-WW	70	26542	PROFILO D 2m	90
24527	ZUBI LED 4W G9-NW	70	26544	PROFILO J	94
24528	ZUBI LED 4W E14-WW	70	26545	PROFILO J 2M	94
24529	ZUBI LED 4W E14-NW	70	26546	PROFILO J-W	94
24530	LEDS-B 7 2W/M IP00RGB	85	26547	PROFILO J-W 2M	94
24531	LEDS-B 7 2W/M IP65RGB	85	26548	PROFILO K	95
24532	LEDS-B 7 2W/M IP54RGB	85	26549	PROFILO K 2m	95
24640	TYBIA LED 38W-NW	239	26550	PROFILO K-W	95
24641	TYBIA LED 38W-NW-SE	239	26551	PROFILO K-W 2m	95
24642	TYBIA LED 38W-NW B	239	26552	PROFILO F	91
24643	TYBIA LED 38W-NW-SE B	239	26553	PROFILO F 2m	91
24644	TYBIA M 25W-NW GY	239	26558	PROFILO G	92
24645	TYBIA M 25W-NW B	239	26559	PROFILO G 2m	92
24646	TYBIA M 25W-NW-SE GY	239	26560	PROFILO H	93
24647	TYBIA M 25W-NW-SE B	239	26561	PROFILO H 2m	93
24651	STONO 30	296	26562	CONNECT-L C	89
24654	STONO 20 N	296	26563	CONNECT C/D/E/I	89
25476	GORD XS DLP 50-B	112	26563	CONNECT C/D/E/I	90
25477	GORD XS DLP 50-W	112	26564	SHADE J/K-FR	94
25478	BORD XS DLP-50-B	112	26564	SHADE J/K-FR	95
25479	BORD XS DLP-50-W	112	26565	SHADE J/K-W	94
25591	PSR 100	213	26565	SHADE J/K-W	95
25690	PLAFMIN O	244	26566	SHADE J/K-FR 2m	94
25710	REGIS 3WS EVG 418 PT	216	26566	SHADE J/K-FR 2m	95
25711	NOTUS 3WS EVG 418 NT	218	26567	SHADE J/K-W 2m	94
25712	NOTUS 3WS EVG 236 NT	218	26567	SHADE J/K-W 2m	95
25713	REGIS 3WS OPAL 418 PT	216	26568	SHADE B/F-FR	88
25720	AKVEN LED	300	26568	SHADE B/F-FR	91
25780	IVIAN LED 4,5W W-WW	253	26569	SHADE B/F-W	88
25781	IVIAN LED 4,5W SN-WW	253	26569	SHADE B/F-W	91
25782	IVIAN LED 4,5W W-NW	253	26570	SHADE B/F-FR 2M	88
25783	IVIAN LED 4,5W SN-NW	253	26570	SHADE B/F-FR 2M	91
25990	NAVI CTX-DS10-B	179	26571	SHADE B/F-W 2M	88
25991	NAVI CTX-DT10-B	179	26571	SHADE B/F-W 2M	91
25995	VIDI CTC-5514-B	180	26572	SHADE C/D/E/I-FR	89
25996	VIDI CTC-5515-B	180	26572	SHADE C/D/E/I-FR	90
26039	ST 45 LED 0,5W E27-BL	50	26573	SHADE C/D/E/I-FR 2M	89
26045	ST 45 LED 0,5W E27-WW	50	26573	SHADE C/D/E/I-FR 2M	90
26046	ST 45 LED 0,5W E27-NW	50	26574	SHADE C/D/E/I-W	89
26047	ST64 A 4W-SW	51	26574	SHADE C/D/E/I-W	90
26048	ST 45 LED 0,5W E27-GR	50	26575	SHADE C/D/E/I-W 2M	89
26049	ST 45 LED 0,5W E27-RE	50	26575	SHADE C/D/E/I-W 2M	90
26058	T8 LED GLASSv3 22W-NW	74	26576	SHADE CK C/D/E/I-FR	89
26059	T8 LED GLASSv3 22W-CW	74	26576	SHADE CK C/D/E/I-FR	90
26062	T8 LED GLASSv3 9W-NW	74	26577	SHADE CK C/D/E/I-FR2M	89
26063	T8 LED GLASSv3 9W-CW	74	26577	SHADE CK C/D/E/I-FR2M	90
26064	T8 LED GLASSv3 18W-NW	74	26578	SHADE CK C/D/E/I-W	89
26065	T8 LED GLASSv3 18W-CW	74	26578	SHADE CK C/D/E/I-W	90
26068	T8LED GLASSv3T 18W NW	74	26579	SHADE CK C/D/E/I-W 2M	89
26069	T8 LED STARTER	74	26579	SHADE CK C/D/E/I-W 2M	90
26303	QULES AC O-W	187	26580	SHADE CK G	92
26304	QULES AC O-C/M	187	26581	SHADE CK G 2M	92
26306	QULES AC O-B	187	26582	SHADE-U H-FR	93
26326	COB SET 3m DIM-WW	86	26583	SHADE-U H-FR 2m	93
26327	COB SET 3m DIM-NW	86	26584	SHADE-U H-W	93
26360	ALDO 4LED 1X60	228	26585	SHADE-U H-W 2m	93
26361	ALDO 4LED 1X120	228	26586	SHADE-O H-W	93
26362	ALDO 4LED 1X150	228	26587	SHADE-O H-W 2m	93
26364	ALDO 4LED 2X120	228	26588	STOPPER J	94
26365	ALDO 4LED 2X150	228	26589	STOPPER K	95
26440	VARSO LED 18W-WW-O	234	26590	STOPPER F	91
26441	VARSO LED 18W-NW-O	234	26592	STOPPER G	92
26443	VARSO LED 18W-NW-L	234	26593	STOPPER-U H	93
26444	VARSO LED 24W-WW-O	234	26594	STOPPER-O H	93
26445	VARSO LED 24W-NW-O	234	26595	HANDLE J/K	94
26447	VARSO LED 24W-NW-L	234	26595	HANDLE J/K	95
26448	VARSO HI 36W-NW-O	234	26596	HANDLE B/F	88
26449	VARSO HI 36W-NW-L	234	26596	HANDLE B/F	91
26461	TAXI SMD L C/M-NW	279	26597	HANDLE C/D/E/I	89
26463	TAXI SMD P C/M-NW	279	26597	HANDLE C/D/E/I	90
26520	SANSO LED 15W-NW-SE	243	26598	HANDLE G	92
26536	APUS LED AC B-NW	196	26599	HANDLE H	93
26537	APUS LED AC B-WW	196	26600	HANDLE SIDE H	93
26538	APUS LED B-NW	196	26602	SEALINGS G	92
26539	APUS LED B-WW	196	26604	CONNECT-L B	88

26605	STOPPER J-W	94	27115	TP SLIM LED 40W-NW	221
26606	STOPPER K-W	95	27116	TP SLIM LED 50W-NW	221
26680	ASTEN LED IP44 8W-NW	190	27117	TP SLIM TW LED 40W-NW	221
26681	ASTEN LED IP44 12W-NW	190	27118	TP SLIM TW LED 50W-NW	221
26682	ASTEN LED IP44 15W-NW	190	27155	HB PRO LED HI 100W-NW	272
26683	ASTEN IP44 8W-NW-B	190	27156	HB PRO LED HI 150W-NW	272
26684	ASTEN IP44 12W-NW-B	190	27157	HB PRO LED HI 200W-NW	272
26685	ASTEN IP44 15W-NW-B	190	27212	KANTI V2LED 12W-NW-SN	261
26686	ASTEN IP44 8W-NW-W	190	27213	KANTI V2LED 18W-NW-SN	261
26687	ASTEN IP44 12W-NW-W	190	27216	KATRO V2LED 24W-NW-SN	258
26688	ASTEN IP44 15W-NW-W	190	27220	ROUNDA V2LED24W-NW-SN	256
26700	ROLSO LED IP44 15W-NW	189	27221	ROUNDA V2LED6W-NW-SN	256
26714	MORTA OCT-SR	174	27318	IQ-LED ES-111 12W-WW	72
26715	MORTA OCT-B	174	27319	IQ-LED ES-111 12W-NW	72
26716	MORTA CT-DT050-SR	173	27322	SPAG S B/G AWY	162
26717	MORTA CT-DT050-B	173	27324	SPAG C B/G AWY	162
26718	MORTA CT-DTL50-SR	173	27326	SPAG D B/G AWY	162
26719	MORTA CT-DTL50-B	173	27327	SPAG D W/G AWY	162
26720	ARET 1XMR16-W	175	27370	APUS LED PIR WW	196
26723	ARET 2XMR16-W	175	27378	APUS LED W-NW	196
26726	ALOR DSL-W	169	27379	APUS LED PIR NW	196
26727	ALOR DSL-B	169	27482	PICTO ONTEC G D5	349
26731	ALOR DTL-W	169	27483	PICTO ONTEC G D2	349
26732	ALOR DTL-B	169	27484	PICTO ONTEC G D3	349
26736	IVRI DTO-W	175	27485	PICTO ONTEC G D8	349
26738	APRILA DTO-W	165	27488	PICTO ONTEC G D7	349
26740	COLIE DTO-W	177	27490	PICTO ONTEC G W1	349
26741	COLIE DTO-G	177	27497	PICTO ONTEC G F1	349
26743	COLIE DTO-B	177	27498	PICTO ONTEC G F2	349
26744	COLIE DTO-GR	177	27499	PICTO ONTEC G DB	349
26747	NESTA DSL-C	177	27500	PICTO ONTEC G DC	349
26748	NESTA DSL-C/M	177	27505	PICTO ONTEC S D5	350
26751	NESTA DTL-C	177	27506	PICTO ONTEC S D2	350
26752	NESTA DTL-C/M	177	27507	PICTO ONTEC S D3	350
26753	ALREN DTL-W	176	27508	PICTO ONTEC S D8	350
26754	ALREN DTL-B	176	27509	PICTO ONTEC S D1	350
26756	ALREN DTL-C/M	176	27510	PICTO ONTEC S D6	350
26757	ALREN R DTL-B	176	27511	PICTO ONTEC S D7	350
26758	ALREN R DTL-W	176	27512	PICTO ONTEC S D4	350
26766	BILO 6,5W E14-NW	64	27513	PICTO ONTEC S W1	350
26767	BILO 6,5W E14-WW	64	27514	PICTO ONTEC S W2	350
26768	BILO 6,5W E27-NW	64	27520	PICTO ONTEC S F1	350
26769	BILO 6,5W E27-WW	64	27522	PICTO ONTEC S DB	350
26770	AVAR 6060 40W-NW	214	27523	PICTO ONTEC S DC	350
26771	AVAR 6060 40W-CW	214	27527	ONTEC S M1180MSTW	344
26773	AVAR 6262 40W-NW	214	27528	ONTEC S 20M1X ST W	344
26774	AVAR 6262 40W-WW	214	27529	ONTEC S 20M1X AT W	344
26790	ALOR DSO-W	169	27558	SOLA LED B-NW	199
26791	ALOR DSO-B	169	27559	SOLA LED B-WW	199
26795	ALOR DTO-W	169	27567	RITI GU10 B/B	111
26796	ALOR DTO-B	169	27569	RITI GU10 W/W	111
26810	POWELED P 12V 30W	335	27570	RITI GU10 W/G	111
26811	POWELED P 12V 60W	335	27571	RITI GU10 B/G	111
26815	POWELED P 24V 30W	335	27575	MINI RITI GU10 B/G	163
26816	POWELED P 24V 60W	335	27576	MINI RITI GU10 W/G	163
26820	SENTO	332	27577	MINI RITI GU10 B/W	163
26821	SENZO	332	27578	MINI RITI GU10 B/B	163
26830	STOBI DLP 50-B	110	27579	MINI RITI GU10 W/W	163
26831	STOBI DLP 50-W	110	27590	LINUS LED 4W-NW	204
26832	STOBI DLP 250-B	110	27591	LINUS LED 7W-NW	204
26833	STOBI DLP 250-W	110	27602	HERON II LED B	152
26840	APUS LED W-WW	196	27603	HERON II LED W	152
26841	APUS LED W-CW	196	27610	ADTR 6060 SR	209
26842	TERRA LED W-WW	197	27610	ADTR 6060 SR	213
26843	TERRA LED W-CW	197	27611	ADTR 12030 W	209
26848	TERRA LED B-NW	197	27611	ADTR 12030 W	213
26849	TERRA LED B-WW	197	27612	ADTR 12030 SR	209
26961	MEBA 4LED 2X120 PS	227	27612	ADTR 12030 SR	213
26964	MEBA 4LED 2X120 OP PS	227	27613	ADTR 6060 W	209
26965	MEBA 4LED 2X150 OP PS	227	27613	ADTR 6060 W	213
26980	VARSO LED 18W-NW-L-SE	234	27614	ADTR 12030 B	209
26981	VARSO LED 18W-NW-O-SE	234	27614	ADTR 12030 B	213
26983	VARSO LED 24W-NW-L-SE	234	27615	ADTR 6060 B	209
26984	VARSO LED 24W-NW-O-SE	234	27615	ADTR 6060 B	213
26985	VARSO HI 36W-NW-O-SE	234	27616	ADTR-S 6060 W	209
27000	ETISSA D20 GR	106	27617	ADTR-S-H 6060 W	209
27001	OGIVA D35 GR	106	27652	ONTECS C1302MATW	344

INDEKS WEDŁUG KODÓW

INDEX BY CODES

27769	ITECH M1 60 NM ST W	346	29001	GORI EL 235 D	292
27800	ELNIS S W	170	29002	GORI 50	292
27804	ELNIS L W	170	29003	GORI 80	292
27805	ELNIS L W/A	170	29010	VADRA 16L-UP	293
27806	ELNIS L W/C	170	29011	VADRA 21L-UP SE	293
27808	ELNIS L A/C	170	29012	VADRA 50	293
27809	ELNIS L A	170	29013	VADRA 80	293
27810	ELNIS L B/G	170	29031	IMINES DSO-W	165
28002	BRAVO PU36W6060NW W	212	29098	ONTEC R M1 60N M STW	348
28010	BRAVO S 40W6060NW W	212	29110	MILENO EL-10 B-AG	138
28022	BRAVO S 40W12030NW W	212	29111	MILENO EL-10 ASR-AN	138
28025	BRAVO DRIVER 36W	212	29112	MILENO EL-30 B-AG	138
28026	BRAVO DRIVER 40W	212	29113	MILENO EL-30 ASR-AN	138
28029	BRAVO DRIVER 28W	212	29114	MILENO EL-21 B-AG	138
28500	BRAVO S/P GRIP 60-62	213	29115	MILENO EL-21 ASR-AN	138
28501	BRAVO S/P GRIP 12030	213	29116	MILENO EL-31 B-AG	138
28502	CLIPS BRAVO S/P 60-62	213	29117	MILENO EL-31 ASR-AN	138
28503	CLIPS BRAVO S/P 12030	213	29118	MILENO EL-41 B-AG	138
28504	SPN BRAVO S/P 60-62	213	29119	MILENO EL-41 ASR-AN	138
28505	SPN BRAVO S/P 12030	213	29120	LAURIN EL-10 W	132
28508	BRAVO DALI SET 36W	212	29121	LAURIN EL-10 B	132
28512	AVAR DALI SET 40W	214	29122	LAURIN EL-21 W	132
28515	BLINGO DALI SET 38W	211	29123	LAURIN EL-21 B	132
28515	BLINGO DALI SET 38W	211	29124	LAURIN EL-31 W	132
28551	BRAVO PU28W3060NW W	212	29125	LAURIN EL-31 B	132
28760	ENALI EL-10 W	136	29126	LAURIN EL-30 W	132
28761	ENALI EL-10 B	136	29127	LAURIN EL-30 B	132
28762	ENALI EL-21 W	136	29128	LAURIN EL-40 W	132
28763	ENALI EL-21 B	136	29129	LAURIN EL-40 B	132
28764	ENALI EL-30 W	136	29131	SIMEN DSL B/W/B	168
28765	ENALI EL-30 B	136	29132	SIMEN DSL SR/B/B	168
28766	ENALI EL-31 W	136	29134	SIMEN DSL B/G/B	168
28767	ENALI EL-31 B	136	29135	SIMEN DSL W/G/W	168
28768	ENALI EL-41 W	136	29137	SIMEN DSO B/G	168
28769	ENALI EL-41 B	136	29138	SIMEN DSO B/W	168
28780	MINI GORD DLP-50-W	163	29139	SIMEN DSO W/B	168
28781	MINI GORD DLP-50-B	163	29140	SIMEN DSO W/G	168
28782	MINI BORD DLP-50-W	164	29142	SIMEN DSO G/W	168
28783	MINI BORD DLP-50-B	164	29160	ORTE LED 18W-NW-O	237
28930	ROUND A V2LED12W-NW-SR	256	29161	ORTE LED 24W-NW-O	237
28931	ROUND A V2LED12W-NW-W	256	29162	ORTE LED 18W-NW-O-SE	237
28932	ROUND A V2LED12W-WW-W	256	29163	ORTE LED 24W-NW-O-SE	237
28933	ROUND A V2LED18W-NW-SR	256	29170	INVO OP EL-53-L-GR	294
28934	ROUND A V2LED18W-NW-W	256	29171	INVO OP 47-L-GR	294
28935	ROUND A V2LED18W-WW-W	256	29172	INVO OP 77-L-GR	294
28936	ROUND A V2LED24W-NW-W	256	29173	INVO OP 107-L-GR	294
28937	ROUND A V2LED6W-NW-W	256	29174	INVO TR EL-53-O-GR	295
28938	ROUND A V2LED6W-WW-W	256	29175	INVO TR 47-O-GR	295
28939	KATRO V2LED 12W-NW-SR	258	29176	INVO TR 77-O-GR	295
28940	KATRO V2LED 12W-NW-W	258	29177	INVO TR 107-O-GR	295
28941	KATRO V2LED 12W-WW-W	258	29205	JASMIN 470-B	122
28942	KATRO V2LED 18W-NW-SR	258	29207	JASMIN 270-B	122
28943	KATRO V2LED 18W-NW-W	258	29208	JASMIN 370-B	122
28945	KATRO V2LED 24W-NW-W	258	29209	JASMIN B-W	121
28946	KATRO V2LED 6W-NW-W	258	29210	MERA LED 5W NW	203
28948	CARSA V2LED 12W-NW-W	260	29211	MERA LED 10W NW	203
28949	CARSA V2LED 18W-NW-W	260	29212	MERA LED 15W NW	203
28950	KANTI V2LED 12W-NW-W	261	29213	MERA LED 20W NW	203
28951	KANTI V2LED 18W-NW-W	261	29214	MERA LED PP	203
28961	POWELED P 12V 100W	335	29222	STATO N LED 30W-B	267
28962	POWELED P 24V 100W	335	29223	STATO N LED 50W-B	267
28963	POWELED P 12V 150W	335	29231	GOVIK DSO-W/G	160
28964	POWELED P 24V 150W	335	29232	GOVIK DSO-B/G	160
28965	POWELED P 12V 200W	335	29233	GOVIK-ST DSO-W/G	160
28966	POWELED P 24V 200W	335	29234	GOVIK-ST DSO-B/G	160
28973	ONTEC S M1180MATW	344	29235	GOVIK DSO-W A	160
28974	ZEST MON OS010 W	345	29236	GOVIK DSO-B A	160
28976	ONTEC G E1E 301 M STW	347	29237	GOVIK-ST DSO-B	160
28977	ONTEC S C1302MATWCLD	344	29238	GOVIK-ST DSO-W	160
28978	ONTEC S C160NMATW	344	29240	SANI IP44 DSO-B	107
28979	ONTEC G E1E180MATW	347	29241	SANI IP44 DSO-W	107
28985	ZEST POD OR00 B	345	29242	SANI IP44 DSO-SN	107
28990	REKA LED EL 7W-L-GR	274	29260	BISO LED EL 8W-GR	275
28991	REKA LED EL 7W-O-GR	274	29261	BISO LED EL 8W-W	275
28992	REKA LED EL 7W-L-W	274	29270	GARTO LED EL 8W-GR	275
28993	REKA LED EL 7W-O-W	274	29271	GARTO LED EL 8W-W	275
29000	GORI EL 135 D	292	29300	MODv2 LED 12W-WW	78

29301	MODv2 LED 12W-NW	78	32495	MEFIS LED W-NW	200
29302	MODv2 LED 19W-WW	78	32497	MEFIS LED B-NW	200
29303	MODv2 LED 19W-NW	78	32500	MARIN CT-S80-W	187
29310	CHIRO GU10 DTO-W	162	32501	MARIN CT-S80-B	187
29311	CHIRO GU10 DTO-B	162	32520	TONIL LED B	143
29313	CHIRO GU10 DTL-B	162	32521	TONIL LED W	143
29580	AREL LED DO 6W-NW	252	32930	MATEO ES DLP-150-B	253
29581	AREL LED DO 6W-WW	252	32931	MATEO ES DLP-150-W	253
29582	AREL LED DL 6W-NW	252	32932	MATEO ES DLP-250-B	253
29584	AREL LED DO 10W-NW	252	32933	MATEO ES DLP-250-W	253
29585	AREL LED DO 10W-WW	252	32940	BENO 18W NW-O-W	233
29586	AREL LED DL 10W-NW	252	32942	BENO 18W NW-L-W	233
29588	AREL LED DO 14W-NW	252	32944	BENO 18W NW-O-SE W	233
29589	AREL LED DO 14W-WW	252	32946	BENO 18W NW-L-SE W	233
29590	AREL LED DL 14W-NW	252	32948	BENO N 18W NW-O-SE GR	233
29600	XLED A60 4,5W-WW	44	32949	BENO N 18W NW-L-SE GR	233
29601	XLED A60 7W-WW	44	32952	BLURRO 2xGU10 CO-B	113
29602	XLED A60 7W-NW	44	32953	BLURRO 2xGU10 CO-W	113
29603	XLED A60 7W-CW	44	33070	REXAR LED W	155
29604	XLED A60 8W-WW	44	33071	REXAR LED B	155
29605	XLED A60 10W-WW	44	33080	REMI LED GU 10-NW	69
29606	XLED A60 10W-NW	44	33081	REMI LED GU 10-WW	69
29607	XLED A60 4,5W-WW-M	46	33082	REMI LED GU 10-CW	69
29608	XLED A60 4,5W-NW-M	46	33090	SEMPRA EL-11 W-SR	134
29609	XLED A60 7W-WW-M	46	33091	SEMPRA EL-11 B-SR	134
29610	XLED A60 7W-NW-M	46	33092	SEMPRA EL-21 W-SR	134
29612	XLED A60 8W-WW-M	46	33093	SEMPRA EL-21 B-SR	134
29613	XLED A60 8W-NW-M	46	33094	SEMPRA EL-31 W-SR	134
29615	XLED A60 10W-WW-M	46	33095	SEMPRA EL-31 B-SR	134
29616	XLED A60 10W-NW-M	46	33096	SEMPRA EL-41 W-SR	134
29617	XLED C35E14 2,5W-WW	58	33097	SEMPRA EL-41 B-SR	134
29618	XLED C35E14 4,5W-WW	58	33100	XLED A60 B22 7W-WW	48
29619	XLED C35E14 4,5W-NW	58	33102	XLED A60 B22 7W-WW-M	48
29620	XLED C35E14 4,5W-WW-M	58	33103	XLED A60 B22 7W-CW-M	48
29621	XLED C35E14 4,5W-NW-M	58	33108	XLED A60 B22 10W-WW-M	48
29622	XLED C35E14 6W-WW-M	58	33109	XLED A60 B22 10W-CW-M	48
29623	XLED C35E14 6W-NW-M	58	33120	FLINI IP44 DSL-B	186
29624	XLED G45 E14 4,5W-WW	62	33121	FLINI IP44 DSL-W	186
29625	XLED G45 E27 4,5W-WW	62	33122	FLINI IP44 DSO-B	186
29626	XLED G45E14 4,5W-WW-M	63	33123	FLINI IP44 DSO-W	186
29627	XLED G45E14 4,5W-NW-M	63	33125	DROXY IP65 DSO-W	186
29628	XLED G45 E14 6W-WW-M	63	33126	DROXY IP65 DSO-B	186
29629	XLED G45 E14 6W-NW-M	63	33130	ATL1 18W-930-S6-W	304
29630	XLED G45E27 4,5W-WW-M	63	33131	ATL1 18W-930-S6-B	304
29631	XLED G45E27 4,5W-NW-M	63	33132	ATL1 18W-940-S6-W	304
29632	XLED G45 E27 6W-WW-M	63	33133	ATL1 18W-940-S6-B	304
29633	XLED G45 E27 6W-NW-M	63	33134	ATL1 30W-930-S6-W	304
29634	XLEDA60 7W-WW-STEPDIM	47	33135	ATL1 30W-930-S6-B	304
29635	XLEDA60 7W-NW-STEPDIM	47	33136	ATL1 30W-940-S6-W	304
29637	XLED ST64 7W-WW	51	33137	ATL1 30W-940-S6-B	304
29638	XLED G125 7W-WW	53	33138	ATL2 GU10-W	306
29641	XLED C35T 2,5W-SW	54	33139	ATL2 GU10-B	306
29646	XLED C35E27 6W-WW-M	58	33140	REF ATL1-18W-S15	305
29647	XLED C35E27 6W-NW-M	58	33141	REF ATL1-18W-S36	305
29648	XLED A70 18W-WW	45	33142	REF ATL1-30W-S15	305
29649	XLED A70 18W-NW	45	33143	REF ATL1-30W-S36	305
29832	LART EL-160-GR	277	33144	ATL3 GU10-B	306
29833	LART EL-260-GR	277	33145	ATL3 GU10-W	306
29840	ADTR 3060 W	213	33146	ATL4 GU10-B	307
29841	ADTR 3060 SR	213	33147	ATL4 GU10-W	307
29842	ADTR 3060 B	213	33148	ATL5 GU10-B	307
29843	ADTR-H 6060 W	209	33149	ATL5 GU10-W	307
29843	ADTR-H 6060 W	211	33165	AGEO DSO-B	165
29844	ADTR-H 6060 SR	209	33166	AGEO DSO-W	165
29845	ADTR-H 6060 B	209	33170	TP STRONG LED 48W-NW	220
29852	SABIK LED B-NW	198	33171	TP STRONG LED 75W-NW	220
29853	SABIK LED B-WW	198	33172	TP STRONG LED 90W-NW ()	220
29854	SABIK MINI LED B-NW	198	33177	BLINGO TN38W 6060 NW	208
29855	SABIK MINI LED B-WW	198	33178	BLINGO TN24-28W6060NW	208
29856	APUS LED PIR B-NW	196	33179	BLINGO TUN48W 6060 NW	208
29857	APUS LED PIR B-WW	196	33188	BLINGO PU 36W 6262 NW	208
29858	SABIK LED PIR B-NW	198	33190	HBPH LENS 50D 100W	273
29860	TERRA LED PIR B-NW	197	33191	HBPH LENS 50D 150W	273
29861	TERRA LED PIR B-WW	197	33192	HBPH LENS 50D 200W	273
32488	APUS LED NW	196	33193	HBPH LENS 120D 100W	273
32490	SABIK MINI LED NW	198	33194	HBPH LENS 120D 150W	273
32491	SOLA LED NW	199	33195	HBPH LENS 120D 200W	273

INDEKS WEDŁUG KODÓW

INDEX BY CODES

33196	HBPH GRID 100W	273	33325	ERINUS LED LL W-NW	194
33197	HBPH GRID 150W	273	33327	ERINUS LED L GR-NW	194
33198	HBPH GRID 200W	273	33329	ERINUS LED O GR-NW	194
33200	ANTEM LED 10W-NW B	266	33330	ERINUS LED LL GR-WW	194
33201	ANTEM LED 20W-NW B	266	33331	ERINUS LED LL GR-NW	194
33202	ANTEM LED 30W-NW B	266	33332	ERINUS LED L B-WW	194
33203	ANTEM LED 50W-NW B	266	33333	ERINUS LED L B-NW	194
33204	ANTEM LED 100W-NW B	266	33334	ERINUS LED O B-WW	194
33205	ANTEM LED 10W-NW-SE B	266	33335	ERINUS LED O B-NW	194
33206	ANTEM LED 20W-NW-SE B	266	33336	ERINUS LED LL B-WW	194
33207	ANTEM LED 30W-NW-SE B	266	33337	ERINUS LED LL B-NW	194
33208	ANTEM LED 50W-NW-SE B	266	33340	BENO 24W NW-O-W	233
33210	T8 LED GLASSv4 9W-NW	75	33341	BENO 24W NW-O-GR	233
33211	T8 LED GLASSv4 9W-CW	75	33342	BENO 24W NW-L-W	233
33212	T8 LED GLASSv4 18W-NW	75	33343	BENO 24W NW-L-GR	233
33213	T8 LED GLASSv4 18W-CW	75	33344	BENO 24W NW-O-SE W	233
33214	T8 LED GLASSv4 24W-NW	75	33345	BENO 24W NW-O-SE GR	233
33215	T8 LED GLASSv4 24W-CW	75	33346	BENO 24W NW-L-SE W	233
33216	T8 LED GLASSv5 12W-NW	75	33347	BENO 24W NW-L-SE GR	233
33217	T8 LED GLASSv5 12W-CW	75	33351	LCO B 10W/M 24 IP00-WW	84
33230	TEAR N TR 1M-W	311	33352	LCO B 10W/M 24 IP65-WW	84
33231	TEAR N TR 1M-B	311	33353	LCO B 10W/M 24 IP00-CW	84
33232	TEAR N TR 2M-W	311	33354	LCO B 10W/M 24 IP65-CW	84
33233	TEAR N TR 2M-B	311	33355	L120B 16W/M 24IP00-WW	81
33234	TEAR N PCON R-W	311	33356	L120B 16W/M 24IP00-NW	81
33235	TEAR N PCON R-B	311	33360	AQILO IP65 DSO-W	108
33236	TEAR N EPLUG W	311	33361	AQILO IP65 DSO-B	108
33237	TEAR N EPLUG B	311	33362	AQILO IP65 DSO-GR	108
33238	TEAR N ICON-I W	311	33364	LCOB 8W/M 12 IP00-WW	83
33239	TEAR N ICON-I B	311	33365	LCOB 8W/M 12 IP65-WW	83
33240	TEAR N CON-I W	310	33366	LCOB 8W/M 12 IP00-NW	83
33241	TEAR N CON-I B	310	33367	LCOB 8W/M 12 IP65-NW	83
33242	TEAR N CON-L RL-W	310	33368	"	84
33243	TEAR N CON-L RL-B	310	33369	LCOB 10W/M 24 IP65-WW	84
33244	TEAR N CON-L LR-W	310	33390	ADTR-H 12030 W	209
33245	TEAR N CON-L LR-B	310	33390	ADTR-H 12030 W	211
33246	TEAR N CON-X W	311	33391	ADTR-H 12030 B	209
33247	TEAR N CON-X B	310	33392	ADTR-H 12030 SR	209
33248	TEAR N CON-T RRL-W	310	33393	ADTR-H 3060 W	211
33249	TEAR N CON-T RRL-B	310	33398	ADTR-H 76MM 6060 W	209
33250	TEAR N CON-T RLL-W	310	33435	ADTR-H 6262 W	209
33251	TEAR N CON-T RLL-B	310	33470	FL AGOR LED 100W NW	262
33252	TEAR N CON-I FLEX W	310	33471	FL AGOR LED 150W NW	262
33253	TEAR N CON-I FLEX B	310	33472	FL AGOR LED 200W NW	262
33254	TEAR N SCLAMP W	311	33473	FL AGOR/A LED 100W	262
33255	TEAR N SCLAMP B	311	33474	FL AGOR/A LED 150W	262
33256	TEAR N SKIT W	311	33475	FL AGOR/A LED 200W	262
33257	TEAR N SKIT B	311	33476	FL AGOR HI 240W NW	263
33260	TEAR N PCON L-W	311	33477	FL AGOR/A HI 240W NW	263
33261	TEAR N PCON L-B	311	33478	FL AGOR HI 300W NW	263
33262	TEAR N CON-T LRR-W	310	33479	FL AGOR/A HI 300W NW	263
33263	TEAR N CON-T LRR-B	310	33482	FL AGOR HI GRID 240W	263
33264	TEAR N CON-T LLR-W	310	33483	FL AGOR HI GRID 300W	263
33265	TEAR N CON-T LLR-B	310	33511	XLED G125 11W-WW	53
33266	TEAR N PADAPTOR-W	313	33512	XLED G125 11W-NW	53
33267	TEAR N PADAPTOR-B	313	33513	XLED ST64C 7W-NW	51
33302	L60 11W/M 12 IP00-WW	80	33514	XLED A60 M 7W-WW	52
33303	L60 11W/M 12 IP00-NW	80	33515	XLED A60 M 7W-NW	52
33304	L60 11W/M 12 IP00-CW	80	33516	XLED A60 4W-SW	54
33305	L60B 11W/M 12 IP00-WW	80	33517	XLED ST64 4W-SW	54
33306	L60B 11W/M 12 IP00-NW	80	33518	XLED G95 4W-SW	54
33307	L60B 11W/M 12 IP00-CW	80	33519	XLED G125 4W-SW	54
33308	L60 11W/M 12 IP65-WW	80	33524	ROUND A V2LED24W-WW-W	256
33309	L60 11W/M 12 IP65-NW	80	33541	CARSA V2LED 24W-NW-W	260
33310	L60 11W/M 12 IP65-CW	80	33562	ROUND A V2LED6W-WW-B	256
33311	L120 16W/M 24 IP00-WW	81	33640	S A60 7W E27 CCT	36
33312	L120 16W/M 24 IP00-NW	81	33641	S A60 9W E27 RGB CCT	36
33314	L120 16W/M 24 IP65-WW	81	33642	S A60 11,5WE27 RGB CCT	36
33315	L120 16W/M 24 IP65-NW	81	33643	S GU10 4,7W RGB CCT	36
33317	L120 16W/M 12 IP00 CCT	82	33644	S C37 4,9W E14 RGB CCT	36
33318	L48 9W/M 24 IP00-RGBW	86	33651	AREL FRAME DO 14W W	252
33319	L48 9W/M 24 IP65-RGBW	86	33670	GALOBA EL-10 W	130
33320	ERINUS LED L W-WW	194	33671	GALOBA EL-10 B	130
33321	ERINUS LED L W-NW	194	33672	GALOBA W 1xGU10 W	143
33322	ERINUS LED O W-WW	194	33673	GALOBA W 1xGU10 B	143
33323	ERINUS LED O W-NW	194	33674	GALOBA EL-21 W	130
33324	ERINUS LED LL W-WW	194	33675	GALOBA EL-21 B	130

33676	GALOBA EL-3I W	130	33881	IQ-LED FL-20W-NW	264
33677	GALOBA EL-3I B	130	33882	IQ-LED FL-30W-NW	264
33678	GALOBA EL-40 W	130	33883	IQ-LED FL-50W-NW	264
33679	GALOBA EL-40 B	130	33884	IQ-LED FL-90W-NW	264
33680	GALOBA EL-4I W	130	33885	IQ-LED FL-10W-NW-SE	264
33681	GALOBA EL-4I B	130	33886	IQ-LED FL-20W-NW-SE	264
33690	GLASI LED 3W P WW-W	279	33887	IQ-LED FL-30W-NW-SE	264
33691	GLASI LED 3W P WW-B	279	33888	IQ-LED FL-50W-NW-SE	264
33692	GLASI LED 3W P WW-GR	279	33889	IQ-LED FL QC I 3x1MM2	264
33693	GLASI LED 3W P NW-W	279	33890	MEBA LED 12-20W NW/WW	227
33694	GLASI LED 3W P NW-B	279	33891	MEBA LED 22-40W NW/WW	227
33695	GLASI LED 3W P NW-GR	279	33892	MEBA LED 20W IP54 NW	226
33701	S AD GN 10A PM	318	33893	MEBA LED 40W IP54 NW	226
33703	S AD GN SCH 10A PM	318	33894	MEBA 4LED 60 IP54 PC	226
33722	IQ-LEDDIM A60 7,3W-WW	42	33895	MEBA 4LED 120 IP54 PC	226
33723	IQ-LEDDIM A60 7,3W-NW	42	33896	MEBA 4LED 150 IP54 PC	226
33724	IQ-LEDDIM A6010,5W-WW	42	34475	NEDIA E14 B	151
33725	IQ-LEDDIM A6010,5W-NW	42	34476	NEDIA E14 W	151
33726	IQ-LEDDIM A6013,6W-WW	42	34920	SONDA II EL-10 B	128
33727	IQ-LEDDIM A6013,6W-NW	42	34921	SONDA II EL-10 W	128
33746	IQ-LED A67 N 19W-WW	41	34922	SONDA II EL-2I B	128
33747	IQ-LED A67 N 19W-NW	41	34923	SONDA II EL-2I W	128
33748	IQ-LED A67 N 19W-CW	41	34924	SONDA II EL-3I B	128
33750	DULI LED 4W-NW-L-GR	278	34925	SONDA II EL-3I W	128
33751	DULI LED 4W-NW-O-GR	278	34926	SONDA II EL-30 B	128
33752	DULI LED 6,5W-NW-L-GR	278	34927	SONDA II EL-30 W	128
33753	DULI LED 6,5W-NW-O-GR	278	34928	SONDA II EL-40 B	128
33760	IQ-LED Life G45 4,2W-WW	38	34929	SONDA II EL-40 W	128
33761	IQ-LED Life G45 4,2W-NW	38	34930	ASTIM IP44 8W-NW-B	189
33762	IQ-LED Life A60 7,2W-WW	38	34931	ASTIM IP44 8W-NW-W	189
33763	IQ-LED Life A60 7,2W-NW	38	34932	ASTIM IP44 8W-NW-C	189
33764	IQ-LED Life GU10 4,8W-WW	38	34933	ASTIM IP44 12W-NW-B	189
33765	IQ-LED Life GU10 4,8W-NW	38	34934	ASTIM IP44 12W-NW-W	189
33769	IQ-LEDEX GU 10 2,5W-NW	65	34935	ASTIM IP44 12W-NW-C	189
33810	ONTEC S W1302MATWCLD	344	34940	S SENSOR PIR INT 10M	316
33812	ITECH M2 302MATW	346	34941	S SENSOR W INT	317
33814	ITECH M5 305MATW	346	34942	S SENSOR ON/OFF INT	316
33815	ITECH C1 302MATW	346	34948	S SWITCH ON/OFF	319
33818	ONTEC S M2302MATWCLD	344	34949	S SWITCH SHUTTER	319
33819	ONTEC S M2102MATWCLD	344	34950	S SWITCH G DOOR	319
33821	ITECH M2 302MSTW	346	34960	TOMiv2 1,2W GU10-CW	68
33822	ITECH M5 105MSTW	346	34961	TOMiv2 1,2W GU10-NW	68
33823	ITECH C1 302 STW	346	34962	TOMiv2 1,2W GU10-WW	68
33824	ITECH F2 105MSTW	346	34963	TOMiv2 2,9W GU10-CW	68
33826	ONTEC R C1 60N M STW	348	34964	TOMiv2 2,9W GU10-NW	68
33829	OPRAWA DWUSTRONNA OSO	345	34965	TOMiv2 2,9W GU10-WW	68
33830	UCHW PODT OS S2 S3 IT	345	34966	TOMiv2 4,9W GU10-CW	68
33832	ITECH M5 105MATW	346	34967	TOMiv2 4,9W GU10-NW	68
33833	ITECH S1 302MATW	346	34968	TOMiv2 4,9W GU10-WW	68
33834	ITECH C2 105MATW	346	34969	TOMiv2 6,5W GU10-CW	68
33835	ITECH F1 302MATW	346	34970	TOMiv2 6,5W GU10-NW	68
33836	ITECH F2 105MATW	346	34971	TOMiv2 6,5W GU10-WW	68
33837	ITECH W2 105MATW	346	34980	VIMO EL 27 B	291
33840	ONTEC S M5105MATW	344	34981	VIMO EL 27 BR	291
33841	ONTEC S M5305MATW	344	34982	VIMO EL 27 SE-B	291
33842	ONTEC S C1302MATW	344	34983	VIMO EL 27 SE-BR	291
33843	ONTEC S C2105MATW	344	34984	VIMO 50 B	291
33844	ONTEC S F2105MATW	344	34985	VIMO 50 BR	291
33845	ONTEC S W1302MATW	344	34986	VIMO 50 SE-B	291
33846	ONTEC S W2105MATWCLD	344	34987	VIMO 50 SE-BR	291
33847	ONTEC C M160NMATW	347	34988	VIMO 80 B	291
33849	ONTEC C C160NMATW	347	34989	VIMO 80 BR	291
33850	ONTEC R M1 60N M ATW	348	35000	STIVI LED 24W-NW-O	236
33851	ONTEC R M2 302 M ATW	348	35001	STIVI LED 24W-NW-O-SE	236
33852	ONTEC R M2 302 M ATW	348	35002	STIVI LED 36W-NW-O	236
33855	ONTEC S M5105MSTW	344	35003	STIVI LED 36W-NW-O-SE	236
33856	ONTEC S M2302MSTWCLD	344	35240	IQ-LED GU10 6,5W-WW	66
33858	ONTEC C M160NMSTW	347	35241	IQ-LED GU10 6,5W-NW	66
33862	ONTEC S C1302MSTW	344	35242	IQ-LED GU10 6,5W-CW	66
33864	ONTEC S F2105MSTW	344	35243	IQ-LED GU10 6,5WS3-WW	66
33865	ONTEC S W1302MSTW	344	35244	IQ-LED GU10 6,5WS3-NW	66
33866	ONTEC S W1302MSTWCLD	344	35245	IQ-LED GU10 6,5WS3-CW	66
33868	ONTEC C C160NMSTW	347	35246	IQ-LEDDIM GU10 7W-WW	67
33871	ZEST MONT OS05	345	35247	IQ-LEDDIM GU10 7W-NW	67
33876	ZEST MONT S20 FLAGA	345	35248	IQ-LEDDIM GU10 7W-CW	67
33877	ZEST MONT OS205	345	35252	IQ-LED AR-111 13W-WW	72
33880	IQ-LED FL-10W-NW	264	35253	IQ-LED AR-111 13W-NW	72

INDEKS WEDŁUG KODÓW

INDEX BY CODES

35254	IQ-LED EX T8 12W-NW	73	35780	PREDA LED B	154
35255	IQ-LED EX T8 12W-CW	73	35781	PREDA LED W	154
35256	IQ-LED GU 10 4,9W-WW	65	35785	EVALO TL GU10 W-SR	148
35257	IQ-LED GU 10 4,9W-NW	65	35786	EVALO TL GU10 B-SR	148
35258	IQ-LED GU 10 4,9W-CW	65	35787	EVALO FL 3xGU10 W-SR	149
35272	XLED C35 E14 6W-WW	58	35788	EVALO FL 3xGU10 B-SR	149
35273	XLED C35 E14 6W-NW	58	35790	TEAR N RC-PCON W	311
35274	XLED G45 E27 6W-WW	62	35791	TEAR N RC-PCON B	311
35275	XLED G45 E27 6W-NW	62	35792	TEAR N RC-CON-L W	311
35276	XLED G45 E14 6W-WW	62	35793	TEAR N RC-CON-L B	312
35277	XLED G45 E14 6W-NW	62	35794	TEAR N RC-CON-I W	311
35278	XLEDIM C35E14 5,9W-WW	57	35795	TEAR N RC-CON-I B	311
35280	ELICEO DSO B/B	172	35796	TEAR N RC-CON-T W	312
35281	ELICEO DSO W/W	172	35797	TEAR N RC-CON-T B	312
35283	ELICEO DSO W/G	172	35798	TEAR N RC-CON-X W	312
35284	ELICEO-ST DSO B/B	172	35799	TEAR N RC-CON-X B	312
35285	ELICEO-ST DSO W/W	172	35800	TEAR N R-TR 2M-W	311
35287	ELICEO-ST DSO W/G	172	35801	TEAR N R-TR 2M-B	311
35288	ELICEO DSO W	172	35802	TEAR N RCLIP-W	312
35289	ELICEO DSO B	172	35803	TEAR N RCLIP-B	312
35295	ELICEO DSO YG	172	36210	GLOZO DSL W/W	157
35296	ELICEO DSO GR	172	36211	GLOZO DSL B/W	157
35297	ELICEO DSO PK	172	36212	GLOZO DSL G/W	157
35298	ELICEO DSO BL	172	36213	GLOZO DSL SR/W	157
35508	RIFA LED 17,5W NW N2	118	36214	GLOZO DSL W/B	157
35509	RIFA LED 17,5W WW N2	118	36215	GLOZO DSL B/B	157
35640	DERATO EL-10 B-SR	124	36216	GLOZO DSL G/B	157
35641	DERATO EL-10 W-SR	124	36217	GLOZO DSL SR/B	157
35642	DERATO EL-21 B-SR	124	36218	GLOZO DSO W/W	156
35643	DERATO EL-21 W-SR	124	36219	GLOZO DSO B/W	156
35644	DERATO EL-30 B-SR	124	36220	GLOZO DSO G/W	156
35645	DERATO EL-30 W-SR	124	36221	GLOZO DSO SR/W	156
35646	DERATO EL-41 B-SR	124	36222	GLOZO DSO W/B	156
35647	DERATO EL-41 W-SR	124	36223	GLOZO DSO B/B	156
35650	BTL 18W-930-W	308	36224	GLOZO DSO G/B	156
35651	BTL 18W-930-B	308	36225	GLOZO DSO SR/B	156
35652	BTL 18W-940-W	308	36228	STRETON LED 20W NW	270
35653	BTL 18W-940-B	308	36229	STRETON LED 40W NW	270
35654	BTL 28W-930-W	308	36230	STRETON LED 60W NW	270
35655	BTL 28W-930-B	308	36231	STRETON LED 100W NW	270
35656	BTL 28W-940-W	308	36232	STRETON LED 150W NW	270
35657	BTL 28W-940-B	308	36233	STRETON LED 200W NW	270
35658	BTL 38W-930-W	308	36241	XLED G95 7W-WW	52
35659	BTL 38W-930-B	308	36242	XLED G95S 5,8W-NW	52
35660	BTL 38W-940-W	308	36243	XLED EX A60 4W-WW	43
35661	BTL 38W-940-B	308	36244	XLED EX A60 4W-NW	43
35662	BT LW 18W-930-W	309	36245	XLED EX A60 5W-WW	43
35663	BT LW 18W-930-B	309	36246	XLED EX A60 5W-NW	43
35664	BT LW 18W-940-W	309	36247	XLED EX A60 7,2W-WW	43
35665	BT LW 18W-940-B	309	36248	XLED EX A60 7,2W-NW	43
35670	TIBERI PRO 20W-940-W	250	36250	AGZAR E14 B	144
35671	TIBERI PRO 20W-940-B	250	36251	AGZAR E14 W	144
35672	TIBERI PRO 30W-940-W	250	36252	AGZAR C 3xE14 B	104
35673	TIBERI PRO 30W-940-B	250	36253	AGZAR C 3xE14 W	104
35674	TIBERI PRO 40W-940-W	250	36254	AGZAR EL-10 B	144
35675	TIBERI PRO 40W-940-B	250	36255	AGZAR EL-10 W	144
35676	TIBERI PRO NT20W-940W	251	36260	LARATA E27 W	145
35677	TIBERI PRO NT20W-940B	251	36261	LARATA E27 B	145
35678	TIBERI PRO NT30W-940W	251	36262	LARATA EL-10 W	145
35679	TIBERI PRO NT30W-940B	251	36263	LARATA EL-10 B	145
35688	EVALO EL-51 W-SR	126	36270	JUSI E27 W	151
35689	EVALO EL-51 B-SR	126	36271	JUSI E27 B	151
35690	EVALO EL-11 W-SR	126	36280	RAIBO E27 B	150
35691	EVALO EL-11 B-SR	126	36281	RAIBO E27 W	150
35692	EVALO EL-21 W-SR	126	36282	RAIBO E27 BL	150
35693	EVALO EL-21 B-SR	126	36283	RAIBO E27 Y	150
35694	EVALO EL-31 W-SR	126	36284	RAIBO E27 GN	150
35695	EVALO EL-31 B-SR	126	36285	RAIBO E27 PK	150
35696	EVALO EL-40 W-SR	126	36320	INITA LED IP54 GN	147
35697	EVALO EL-40 B-SR	126	36321	INITA LED IP54 B	147
35698	EVALO EL-41 W-SR	126	36322	INITA LED IP54 R	147
35699	EVALO EL-41 B-SR	126	36323	INITA LED IP54 Y	147
35750	GRL 6M5E27-B	301	36324	INITA LED IP54 W	147
35754	GRL 11M10E27-B	301	36331	K LED GU10 6W-NW	67
35758	GRL 15M15E27-B	301	36332	K LED GU10 6W-CW	67
35770	ERTON 140 OP-W	244	36333	K LED N GU10 6W-WW	67
35771	ERTON 240 OP-W	244	36381	ONTEC S M2302MSTW	344

36382	ONTEC S M2302MATW	344	36631	ZEPO LFD-T02-W	202
36430	BERG AD-70	282	36632	ZEPO LFD-T02/S-B	202
36432	GRIBLO 7 GR	300	36633	ZEPO LFD-T02/S-W	202
36440	JASMIN 270-G/O	122	36640	AQILO E14 IP65 D50-GR	108
36441	JASMIN 370-G/O	122	36641	AQILO E14 IP65 D50-W	108
36442	JASMIN 470-G/O	122	36642	AQILO E14 IP65 D50-B	108
36443	JASMIN G/O-W	121	36643	AQILO E27 IP65 D50-GR	108
36460	RIFA LED 17,5W NW W/W	118	36644	AQILO E27 IP65 D50-W	108
36461	RIFA LED 17,5W WW W/W	118	36645	AQILO E27 IP65 D50-B	108
36462	RIFA LED 17,5W NW B/W	118	36650	AKVO IP44 15W-NW-W S	192
36463	RIFA LED 17,5W WW B/W	118	36651	AKVO IP44 15W-NW-B S	192
36464	RIFA LED 17,5W NW B/G	118	36652	AKVO IP44 15W-NW-C S	192
36465	RIFA LED 17,5W WW B/G	118	36653	AKVO IP44 20W-NW-W S	192
36466	RIFA LED 17,5W NW GR/G	118	36654	AKVO IP44 20W-NW-B S	192
36467	RIFA LED 17,5W WW GR/G	118	36655	AKVO IP44 20W-NW-C S	192
36468	RIFA LED 17,5W NW N1	118	36656	AKVO IP44 23W-NW-W S	192
36469	RIFA LED 17,5W WW N1	118	36657	AKVO IP44 23W-NW-B S	192
36499	JASMIN C 270-G/O	105	36658	AKVO IP44 23W-NW-C S	192
36500	JASMIN C 370-G/O	105	36659	AKVO IP44 15W-NW-W	193
36501	JASMIN C 470-G/O	105	36660	AKVO IP44 15W-NW-B	193
36502	JASMIN C 270-W/M	105	36661	AKVO IP44 15W-NW-C	193
36503	JASMIN C 370-W/M	105	36662	AKVO IP44 20W-NW-W	193
36504	JASMIN C 470-W/M	105	36663	AKVO IP44 20W-NW-B	193
36505	JASMIN C 270-B	105	36664	AKVO IP44 20W-NW-C	193
36506	JASMIN C 370-B	105	36665	AKVO IP44 23W-NW-W	193
36507	JASMIN C 470-B	105	36666	AKVO IP44 23W-NW-B	193
36510	TAVO LED DO 5W-NW	254	36666	AKVO IP44 23W-NW-C	193
36511	TAVO LED DO 9W-NW	254	36667	IQ-LED A60 3,4W-WW	40
36512	TAVO LED DO 12W-NW	254	36671	IQ-LED A60 3,4W-NW	40
36513	TAVO LED DO 18W-NW	254	36672	IQ-LED A60 3,4W-CW	40
36514	TAVO LED DO 24W-NW	254	36673	IQ-LED A60 5,9W-WW	40
36515	TAVO LED DL 5W-NW	254	36674	IQ-LED A60 5,9W-NW	40
36516	TAVO LED DL 9W-NW	254	36675	IQ-LED A60 5,9W-CW	40
36517	TAVO LED DL 12W-NW	254	36676	IQ-LED A60 7,8W-WW	40
36518	TAVO LED DL 18W-NW	254	36677	IQ-LED A60 7,8W-NW	40
36519	TAVO LED DL 24W-NW	254	36678	IQ-LED A60 7,8W-CW	40
36520	TAVO FRAME DO 12W	254	36679	IQ-LED A60 11W-WW	40
36521	TAVO FRAME DO 18W	254	36680	IQ-LED A60 11W-NW	40
36522	TAVO FRAME DL 12W	254	36681	IQ-LED A60 11W-CW	40
36523	TAVO FRAME DL 18W	254	36682	IQ-LED C35E14 3,4W-WW	56
36530	LIEGO 97 B	290	36683	IQ-LED C35E14 3,4W-NW	56
36531	LIEGO 89 PEND B	290	36684	IQ-LED C35E14 3,4W-VW	56
36532	LIEGO EL 28 UP B	290	36685	IQ-LED C35E14 5,9W-WW	56
36533	LIEGO EL 28 UP SE B	290	36686	IQ-LED C35E14 5,9W-NW	56
36534	LIEGO 37 B	290	36687	IQ-LED C35E14 5,9W-CW	56
36540	PRESO 80 GR	288	36688	IQ-LED G45E14 3,4W-WW	60
36541	PRESO 50 GR	288	36689	IQ-LED G45E14 3,4W-NW	60
36542	PRESO 30 GR	288	36690	IQ-LED G45E14 3,4W-CW	60
36543	PRESO EL 18 GR	288	36691	IQ-LED G45E27 3,4W-WW	60
36545	LAVEN 80 GR	287	36692	IQ-LED G45E27 3,4W-NW	60
36546	LAVEN 50 GR	287	36693	IQ-LED G45E27 3,4W-CW	60
36547	LAVEN EL 28 SE-GR	287	36694	IQ-LED G45E14 5,9W-WW	60
36548	LAVEN EL 25 GR	287	36695	IQ-LED G45E14 5,9W-NW	60
36550	PEVO 80 GR	286	36696	IQ-LED G45E14 5,9W-CW	60
36551	PEVO 50 GR	286	36697	IQ-LED G45E27 5,9W-WW	60
36552	PEVO EL 25 GR	286	36698	IQ-LED G45E27 5,9W-NW	60
36555	SELTO 80 B	289	36699	IQ-LED G45E27 5,9W-CW	60
36556	SELTO 50 B	289	37150	ARGUS II CT-2114-AN	182
36557	SELTO EL 23 B	289	37151	ARGUS II CT-2114-BR/M	182
36560	USTI SP 2X7 GR	298	37152	ARGUS II CT-2114-C	182
36561	USTI SP 1X7 GR	298	37153	ARGUS II CT-2114-C/M	182
36565	VORA SP 20 GR	299	37154	ARGUS II CT-2114-G	182
36566	VORA EL 20 GR	299	37155	ARGUS II CT-2114-GM	182
36570	ABETE LED 60 GR	285	37156	ARGUS II CT-2114-W	182
36571	ABETE LED 80 GR	285	37157	ARGUS II CT-2115-AN	182
36572	ABETE LED EL 20 GR	285	37158	ARGUS II CT-2115-BR/M	182
36573	ABETE LED EL 20 SE-GR	285	37159	ARGUS II CT-2115-C	182
36585	DASTO 2S0C FR B	302	37160	ARGUS II CT-2115-C/M	182
36586	NASTO 2S0C FR B	302	37161	ARGUS II CT-2115-G	182
36591	STONO 390 N	296	37162	ARGUS II CT-2115-GM	182
36592	STONO 490 N	296	37163	ARGUS II CT-2115-W	182
36593	STONO 585 N	296	37165	TINY BORD DTO-B	164
36594	STONO 780 N	296	37166	TINY BORD DTO-B/G	164
36605	FL SOLNAR SLR 8W NW-B	269	37167	TINY BORD DTO-W	164
36606	FL SONE SLR M NW-GR	268	37168	TINY BORD DTO-W/G	164
36607	FL SONE SLR L NW-GR	268	37170	BLINGO 34W 3740 60WW	208
36630	ZEPO LFD-T02-B	202	37171	BLINGO 34W 4080 60NW	208

INDEKS WEDŁUG KODÓW

INDEX BY CODES

37172	BLINGO 34W 4080 60CW	208	37327	VAND LED 17,5W NW B	117
37173	BLINGO U34W 4080 60NW	208	37330	ARVOS LED 37W CCT B	120
37174	BLINGO 34W 4080 120NW	208	37331	ARVOS LED 37W CCT W	120
37175	BLINGO U34W 4080 120N	208	37335	SPN PANEL 60-62	209
37176	BLINGO 38W 4560 60NW	208	37335	SPN PANEL 60-62	211
37177	BLINGO 38W 4560 120NW	208	37336	SPN PANEL 120	209
37178	BLINGO 24W 4320 60NW	208	37336	SPN PANEL 120	211
37179	BLINGO U24W 4000 60NW	208	37337	CLIPS PANEL 60-62	209
37229	NEON MOUNTING CLIP	96	37337	CLIPS PANEL 60-62	211
37230	LCOB 10W/M 12 IP00-WW	83	37338	CLIPS PANEL 120	209
37231	LCOB 10W/M 12 IP00-NW	83	37338	CLIPS PANEL 120	211
37232	LCOB 10W/M 12 IP65-WW	83	37340	XLEDEX C35E14 3,8W-WW	57
37233	LCOB 10W/M 12 IP65-NW	83	37341	XLEDEX C35E14 3,8W-NW	57
37234	NEON LED12W/M IP65-WW	96	37342	XLEDEX G45E14 3,8W-WW	61
37235	NEON LED12W/M IP65-NW	96	37343	XLEDEX G45E14 3,8W-NW	61
37236	NEON LED12W/M IP65-CW	96	37344	XLEDEX G45E27 3,8W-WW	61
37237	NEON LED12W/M IP65-BL	96	37345	XLEDEX G45E27 3,8W-NW	61
37238	NEON END CAP HOLE	96	37346	XLED HP D90E27 26W-NW	98
37239	NEON END CAP	96	37347	XLED HP D46E40 38W-NW	98
37240	XLEDI M A60 E27 11W-WW	47	37360	SQMOTION-W	322
37241	XLEDI M A60 E27 11W-NW	47	37361	SQMOTION-B	322
37242	XLEDI M A60 E27 11W-CW	47	37362	ALER N-W	322
37243	XLEDI M A60 B22 12W-WW	48	37363	ALER N-B	322
37244	XLEDI M A60 B22 12W-CW	48	37364	ZONA MINI-W	323
37250	FELINE DSO B/B	158	37365	ZONA MINI WT-W	323
37251	FELINE DSO G/B	158	37366	SENTO-O-WT-W	324
37252	FELINE DSO W/B	158	37367	SENTO-O-WT-B	324
37253	FELINE DSO W/W	158	37368	SENSQUARE-W	324
37254	FELINE DSO G/W	158	37369	SENSQUARE-B	324
37255	FELINE DSO B/W	158	37370	MERGE-WT-O-W	325
37256	FELINE DSL B/B	159	37380	XLED W A60 8,5W-WW	55
37257	FELINE DSL G/B	159	37381	XLED W ST 64 7W-WW	55
37258	FELINE DSL W/B	159	37382	XLED W C35E14 4,5W-WW	55
37259	FELINE DSL W/W	159	37383	XLED W G45E14 4,5W-WW	55
37260	FELINE DSL B/W	159	37390	CALIZA LED CCT W	142
37261	FELINE DSL G/W	159	37392	IRS3xAAA LED PIR W-NW	200
37265	BLINGO U E125LM 60NW	210	37393	HOFI LED WW W	141
37266	BLINGO U E125LM 120NW	210	37394	ORISA LED WW W	141
37267	BLINGO DRV42W DALI BK	211	37395	ORISA LED WW B	141
37267	BLINGO DRV42W DALI BK	211	37396	ULOV LED DIM WW W	140
37268	BLINGO DRV40W1-10V BK	211	37397	BOLA LED 2xUSB WW W	140
37268	BLINGO DRV40W1-10V BK	211	70522	MILO 7040T	245
37269	BLINGO DRV 32W ON-OFF	211	70523	MILO 7040T/P	245
37269	BLINGO DRV 32W ON-OFF	211	70524	HERMI 7063NB	245
37270	BLINGO DRV 40W ON-OFF	211	70525	INES 7061N	246
37270	BLINGO DRV 40W ON-OFF	211	70910	CYKLON EOL 100	338
37271	BLINGO U E125LM 30NW	210	70911	CYKLON EOL 100B	338
37272	BLINGO DRV 24W ON-OFF	211	70915	CYKLON EOL 120	338
37272	BLINGO DRV 24W ON-OFF	211	70916	CYKLON EOL 120B	338
37290	IPER LED 10W-NW-O	230	70920	CYKLON EOL 150	338
37291	IPER LED 19W-NW-O	230	70921	CYKLON EOL 150B	338
37292	IPER LED 26W-NW-O	230	70926	TWISTER AOL100B	337
37293	IPER LED 35W-NW-O	230	70936	CYKLON EOL 100HT	338
37294	IPER LED 10W-NW-L	230	70937	CYKLON EOL 100P	338
37295	IPER LED 19W-NW-L	230	70938	CYKLON EOL 100T	338
37296	IPER LED 26W-NW-L	230	70941	CYKLON EOL 120HT	338
37297	IPER LED 35W-NW-L	230	70942	CYKLON EOL 120P	338
37298	IPER LED 10W-NW-O-SE	230	70943	CYKLON EOL 120T	338
37299	IPER LED 19W-NW-O-SE	230	70947	CYKLON EOL 150P	338
37300	IPER LED 26W-NW-O-SE	230	70948	CYKLON EOL 150T	338
37301	IPER LED 35W-NW-O-SE	230	70953	TWISTER AOL100T	337
37302	IPER LED 10W-NW-L-SE	230	70956	TWISTER AOL120B	337
37303	IPER LED 19W-NW-L-SE	230	70960	TWISTER AOL120T	337
37304	IPER LED 26W-NW-L-SE	230	70961	WIR ZL100	337
37305	IPER LED 35W-NW-L-SE	230	70962	WIR ZL120	337
37310	FLUXY LED IP44 W	146	72109	HLD-R-GX5,3	343
37311	FLUXY LED IP44 B	146	72333	CLP-REGIS/PT	216
37312	FLUXY LED IP44 BL	146	72333	CLP-REGIS/PT	217
37313	FLUXY LED IP44 GN	146	72369	BR-GZ10	340
37314	FLUXY LED IP44 Y	146	xxx	ALIN LED	16
37320	LUMKO LED 17,5W NW	114	xxx	ALIN LED LINE	18
37321	CARVO LED 17,5W NW	114	xxx	ALIN 4LED	20
37322	BONSA LED 17,5W NW	115	xxx	ALIN 4LED LINE	22
37323	EXATE LED 17,5W NW	115	xxx	OFIS S LED	24
37324	SOLN LED 17,5W NW B/G	116	xxx	HIERRO LED	26
37325	AMAZI LED 17,5W NW B	116	xxx	FUTURIO LED	28
37326	VAND LED 17,5W NW W	117	xxx	ADTR	30

KANLUX SA

ul. Objazdowa 1 - 3, 41 - 922 Radzionków
POLSKA
tel. +48 32/388 74 00
fax +48 32/388 74 99
e-mail: kanlux@kanlux.pl

KANLUX LTD

2703 Sugar Mill Business Park,
Oakhurst Road, LS11 7HL Leeds
UNITED KINGDOM
salesuk@kanlux.com
tel.: +44 (0) 7725249456

KANLUX S.R.O.

Sadová 618, 738 01 Frýdek-Místek
ČESKÁ REPUBLIKA
tel. +420 558 402 511, 603 504 218
fax +420 558 694 250
e-mail: kanlux.cz@kanlux.cz

KANLUX S.R.O.

Zlatovská 2179/28, 911 05 Trenčín
SLOVENSKÁ REPUBLIKA
tel. +421 327 446 385-6
fax +421 327 446 387
e-mail: kanlux.sk@kanlux.sk

KANLUX KFT.

9026 Győr, Bácsai út 153/b
HUNGARY
tel. +36 96 525-467
fax +36 96 319-420
e-mail: info@kanlux.hu

ТОВ КАНЛЮКС

08130, Київська область,
Києво-Святошинський район,
с.Петропавлівська Борщагівка, вул. Соборна,
будинок 1-Б, офіс 617 УКРАЇНА
тел. +38 (044) 585 33 19
факс +38 (44) 585 33 18
e-mail: kanlux_ua@kanlux.com

KANLUX LITHUANIA and LATVIA DISTRIBUTION

tel. +37 065 693 649
e-mail: donatas.pliura@kanlux.com

KANLUX EOOD

Warehouse area Gopet Logistics, 1532 Kazichene, Sofia
BULGARIA
tel. +359 2 421 96 24
fax +359 2 421 96 23
e-mail: kanlux.bg@kanlux.com

KANLUX GMBH

Flugplatz 21, 44319 Dortmund
DEUTSCHLAND
Tel. +49 231 56557255
Fax +49 231 56557256
e-mail: kanlux.gmbh@kanlux.com

KANLUX LIGHTING SRL

Kanlux Lighting S.R.L.Oltenitei 249
Popesti Leordeni, 077160, Ilfov,
ROMANIA
tel. +40 371 474 133
e-mail: comenzi@kanlux.com

KANLUX FRANCE SAS

224 bis, rue Marcadet,
75018 Paris
France
tel. +33 (0) 9 86 23 98 61
e-mail: kanlux.fr@kanlux.com

KANLUX ITALY DISTRIBUTION

mob. +39 (0) 339 833 78 00
e-mail: kanlux.it@kanlux.com

więcej niż
more than light. **światło.**

NOTA PRAWNA

Niniejsza publikacja została przygotowana przez Kanlux SA. Poprzez ciągłe udoskonalanie swojej oferty i dostosowanie jej do wymogów rynkowych i prawnych Kanlux SA zastrzega sobie prawo do wprowadzenia zmian w asortymencie.

Prezentowana publikacja nie jest ofertą w rozumieniu Kodeksu Cywilnego. Rzeczywiste produkty mogą odbiegać od poglądowych zdjęć i rysunków zamieszczonych w publikacji. Wszystkie dane zawarte w publikacji obowiązują w dniu oddania jej do druku tj. 2 listopada 2023.

Kanlux SA nie ponosi odpowiedzialności za brak dostępności produktów zamieszczonych w niniejszej publikacji. Kanlux SA nie ponosi także odpowiedzialności za jakiegokolwiek bezpośrednie, pośrednie, przypadkowe lub jakiegokolwiek inne szkody (w tym również, ale nie wyłącznie, utracone zyski, utracone przychody lub podobne straty ekonomiczne) powstałe w wyniku korzystania z informacji zawartych w niniejszej publikacji.

Kanlux SA zastrzega sobie prawo do błędów i zmian w druku.

LAW NOTICE

This publication has been prepared by Kanlux SA. Through the continuous improvement of its offer and adaptation of it to market and legal requirements, Kanlux SA reserves the right to make changes in its product mix.

This publication is not an offer within the meaning of the Civil Code. Actual products may differ from illustrative photos and drawings included in the publication. All of the data contained in the publication is in force on the date of printing i.e. 2nd of November 2023.

Kanlux SA shall not be liable for the non-availability of products listed in this publication. Kanlux SA also shall not be liable for any direct, indirect, accidental or any other damages (including, but not limited to, lost profits, lost revenues or similar economic losses) arising out of the use of information contained in this publication.

Kanlux SA reserves the right for errors and changes in print.



kanlux.com

