

BAHCO

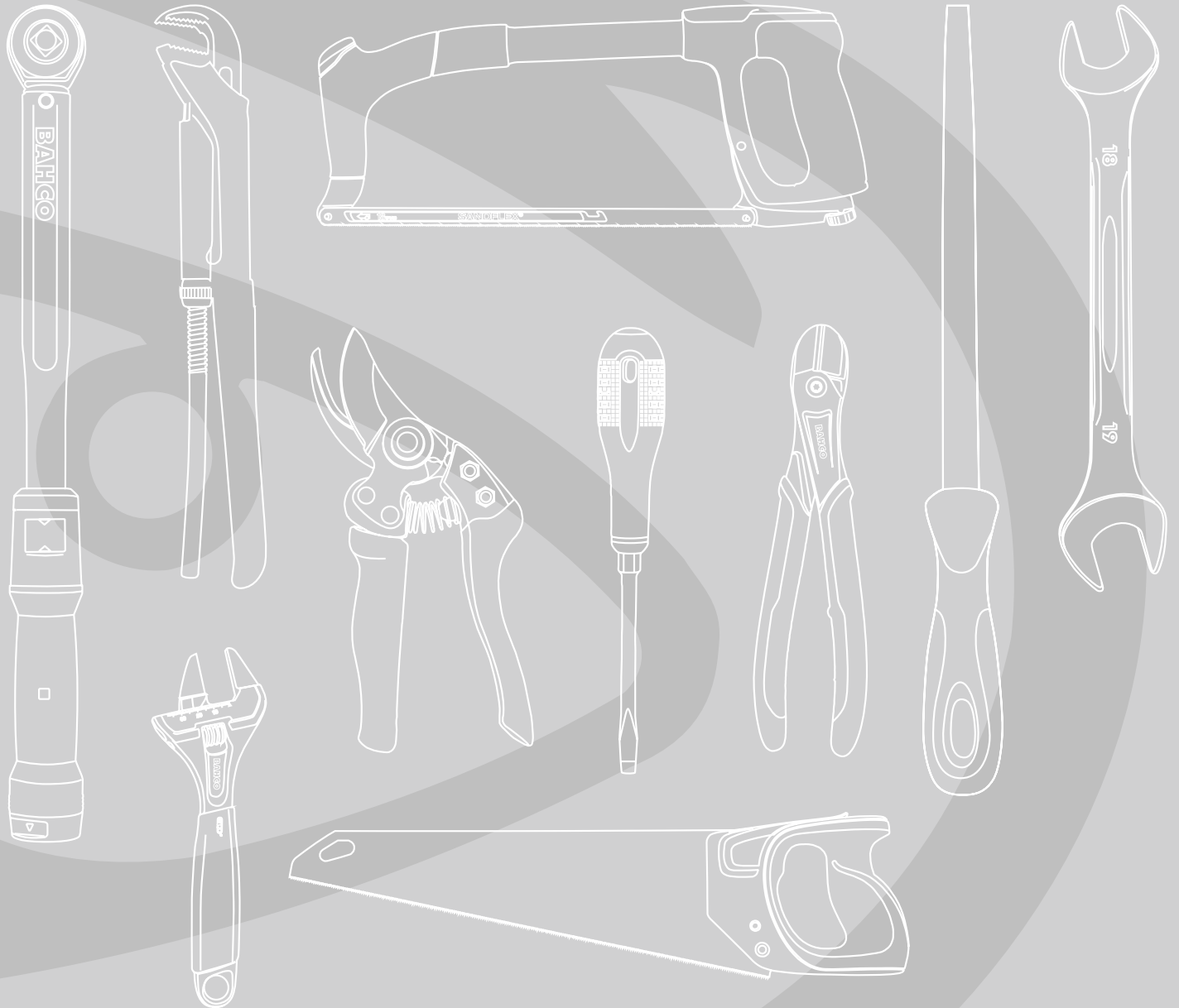

Catalogue
2025

Catalogue 2025

Catalogue

Contents	2-9
Alphanumerical index	649-729
Warranty	735

11-22 BANDSAWS & POWER SAWS

23-38 FILES



39-62 WRENCHES



63-108 SOCKETS & RATCHETS



109-128 TORQUE TOOLS



129-192 POWER TOOL ACCESSORIES



193-226 SCREWDRIVERS



227-234 L-KEYS



235-268 PLIERS



269-276 PIPE WRENCHES & TUBING TOOLS



277-290 AIR TOOLS



291-350 AUTOMOTIVE TOOLS



351-352 LIGHTING EQUIPMENT



353-356 INSPECTION TOOLS



357-366 EXTRACTORS & PULLERS



367-456 TOOL STORAGE & TOOLKITS



457-478 TOOLS @ HEIGHT



479-492 INSULATED TOOLS



493-512 NON SPARKING TOOLS



513-518 STAINLESS STEEL TOOLS



519-524 TWEEZERS & ELECTRONICS SPECIALTY TOOLS



525-534 MEASURING & LAYOUT



535-542 WALL TOOLS



543-546 HAND HACKSAWS



547-556 HANDSAWS



557-562 WOOD CHISELS



563-572 SCISSORS & KNIVES



573-576 CLAMPS & VICES

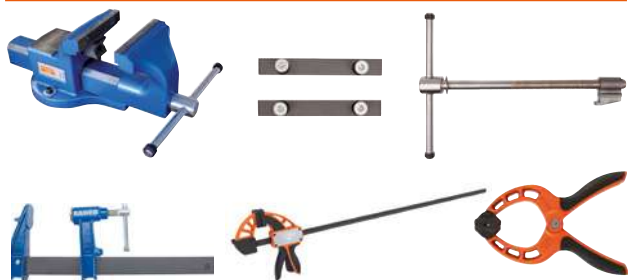

577-584 HAMMERS



585-588 TREE FELLING & FORESTRY TOOLS



589-596 COLD CHISELS & PUNCHES



597-600 PRY BARS



601-604 PLANTING & CULTIVATING TOOLS



605-622 PRUNING TOOLS



623-626 AIR TOOLS OUTDOOR



627-648 LINDSTRÖM



Contents

Bandsaws & Power Saws	11-22	Screwdrivers	193-226
METAL CUTTING BI-METAL BANDSAWS	12	ERGO™ SCREWDRIVERS WITH RIDGED RUBBER GRIP & COLOUR ID	194
METAL CUTTING TRI-METAL BANDSAWS	15	ERGO™ SCREWDRIVERS WITH IMPACT GRIP	204
METAL CUTTING CARBIDE BANDSAWS	15	BAHCOFIT SCREWDRIVERS WITH GROOVED RUBBER GRIP	206
WOOD CUTTING BANDSAW	17	SCREWDRIVERS WITH RUBBERED GRIP	214
INSULATION CUTTING BANDSAWS	18	SCREWDRIVERS WITH RATCHETING GRIP	217
HSS CIRCULAR SAWBLADES	18	SCREWDRIVERS WITH PRECISION GRIP	219
POWER HACKSAW BLADES	19	SCREWDRIVERS WITH T-HANDLE GRIP	222
BANDSAW ACCESSORIES	21	SCREWDRIVERS WITH 1/4" BIT HOLDERS	223
		SCREWDRIVERS WITH WOODEN OR PLASTIC GRIP	223
		ELECTRICAL TESTERS	225
		ACCESSORIES	226
Files	23-38	L-Keys	227-234
ENGINEERING FILES	24	HEXAGONAL TIPPED	228
SHARPENING FILES	28	TORX® TIPPED	232
RASPS	32	DOUBLE OFFSET	234
MILLED TOOTH FILES	33	MULTITOOLS	234
NEEDLE FILES	33		
DIAMOND FILES	36		
ACCESSORIES	37		
Wrenches	39-62	Pliers	235-268
ADJUSTABLE WRENCHES	40	CUTTING PLIERS	236
COMBINATION WRENCHES	42	COMBINATION PLIERS	243
RATCHETING WRENCHES	47	GRIPPING PLIERS	244
OPEN END WRENCHES	50	WATERPUMP PLIERS	250
RING END WRENCHES	54	CIRCLIP PLIERS	252
FLARE NUT WRENCHES	56	WIRE STRIPPERS & DISMANTLING TOOLS	255
SLOGGING WRENCHES	57	CRIMPING PLIERS	258
SOCKET WRENCHES	58	PLIERS SETS	261
MULTIFITTING KEYS	61	LOCKING PLIERS	262
HOOK WRENCHES	62	RIVETING TOOLS	266
		SPECIAL PLIERS	267
Sockets & Ratchets	63-108	Pipe Wrenches & Tubing Tools	269-276
SOCKET SETS	64	PIPE WRENCHES	270
1/4"	81	TUBE CUTTING TOOLS	271
3/8"	88	BENDING & FORMING TOOLS	274
1/2"	95	DEBURRING TOOLS	274
3/4"	103		
1"	106		
EMPTY SOCKET SET CASES	107		
SCAFFOLDING WRENCHES	107		
Torque Tools	109-128	Air Tools	277-290
DIGITAL TORQUE WRENCHES	110	IMPACT WRENCHES	278
MECHANICAL TORQUE WRENCHES	112	RATCHETS	280
TORQUE SCREWDRIVERS	117	GRINDERS, SANDERS & POLISHERS	281
MULTIPLIERS	119	DRILLS & SCREWDRIVERS	285
TORQUE TESTERS	120	CUTTING TOOLS	286
TORQUE ANGLE ADAPTORS	121	HAMMERS, RIVETERS & MARKERS	287
INSERT TOOLS	121	PAINT GUNS	288
EMPTY SET CASES FOR TORQUE TOOLS	127	BLOWING & CLEANING TOOLS	288
		AIR TOOLS ACCESSORIES & EQUIPMENT	289
Power Tool Accessories	129-192	Automotive Tools	291-350
HOLESAWS	130	ENGINE TOOLS	292
SABRE SAWBLADES	140	EXHAUST TOOLS	314
JIGSAW BLADES	144	OIL SERVICE TOOLS & EQUIPMENT	315
MULTI TOOL ACCESSORIES	144	BRAKE SYSTEM TOOLS & EQUIPMENT	319
CIRCULAR SAW BLADES	147	TRANSMISSION & WHEEL TOOLS	323
ABRASIVE CUTTING DISCS	148	SUSPENSION TOOLS & EQUIPMENT	331
BANDSAW BLADES	149	BATTERY MANAGEMENT & ELECTRICAL TOOLS	331
CARBIDE ROTARY BURRS	149	PRESSES & ACCESSORIES	336
DRILL BITS	154	GENERAL AUTOMOTIVE TOOLS AND EQUIPMENT	337
SCREWDRIVER BITS	162	BODY SHOP TOOLS	339
IMPACT SOCKETS	179	LIFTING EQUIPMENT	344



Lighting Equipment **351-352**

HAND LIGHTS	352
HEAD LIGHTS	352
CABLE REELS	352

Inspection Tools **353-356**

ENDOSCOPES	354
STETHOSCOPES	354
MIRRORS	354
MAGNIFIERS	355

Extractors & Pullers **357-366**

MECHANICAL	358
PRY BARS	364
PICKING TOOLS	365
THREAD TOOLS	365

Tool Storage & Toolkits **367-456**

TOOL TROLLEYS	368
RIGID CASES	425
CABINETS, PANELS & WORKBENCHES	435
METALLIC TOOL BOXES	441
PLASTIC BOXES & CASES	449
TEXTILE & LEATHER EQUIPMENT	450

Tools @ Height **457-478**

TOOL STORAGE & LANYARDS	458
WRENCHES	460
PIPE WRENCHES	462
SOCKETS & RATCHETS	463
SCREWDRIVERS	467
PLIERS	469
CUTTING TOOLS	471
HAMMERS, PRY BARS & CHISELS	473
MEASURING & LAYOUT	475
TORQUE TOOLS	476
CLAMPING TOOLS	477
OTHER TOOLS	477
GLOVES	478

Insulated Tools **479-492**

SCREWDRIVERS	480
PLIERS	486
WRENCHES	489
INSULATED SOCKETS & RATCHETS	490
SCISSORS & KNIVES	490
TWEEZERS	491
PROTECTIVE EQUIPMENT	491
TOOLSETS	491

Non Sparking Tools **593-512**

WRENCHES	494
PIPE WRENCHES & VALVE TOOLS	499
SOCKETS & RATCHETS	500
SCREWDRIVERS	503
PLIERS	504
HAMMERS, PRY BARS & CHISELS	506
SCRAPERS	509
DIGGING TOOLS	511
EXTRACTORS & PULLERS	511
TORQUE TOOLS	512

Stainless Steel Tools **513-518**

TROLLEYS	514
WRENCHES	514
SOCKETS & RATCHETS	515
SCREWDRIVERS	516
L-KEYS	517
SCREWDRIVER BITS	517
PLIERS	518
HAMMERS	518
PUNCHES & COLD CHISELS	518

Tweezers & Electronics Specialty Tools **519-524**

TWEEZERS	520
SOLDERING TOOLS	522
FINE MECHANICAL	523

Measuring & Layout **525-534**

MEASURING TAPES	526
MEASURING WHEELS	527
SPIRIT LEVELS	527
MARKING	530
RULES	531
SQUARES	532
PRECISION MEASURING	533

Wall Tools **535-542**

SCRAPERS	536
MASONRY TOOLS	538
DRYWALL TOOLS	540

Hand Hacksaws **543-546**

HAND HACKSAW FRAMES	544
HAND HACKSAW BLADES	545

Handsaws **547-556**

HANDSAWS FOR CONSTRUCTION MATERIAL	548
HANDSAWS FOR WOOD	549
PRECISION HANDSAWS	553
HANDLES & SHARPENERS	554
FRET SAWS & SAWBLADES	554
COPING SAWS & SAWBLADES	555
MUSICAL SAW	555

Wood Chisels **557-562**

WOODWORKING CHISELS	558
GOUGE CHISELS	560
DEMOLITION CHISELS	560
WOOD CHISEL ACCESSORIES	561

Scissors & Knives **563-572**

METAL SHEARS	564
SCISSORS	565
KNIVES	566

Clamps & Vices **573-576**

CLAMPS	574
BENCH VICES	575
BENCH VICE ACCESSORIES	576

Hammers	577-584
CLAW HAMMERS	578
NAIL PULLERS	579
ENGINEERING HAMMERS	579
CONSTRUCTION HAMMERS	580
SPECIALTY HAMMERS	582
SLEDGE HAMMERS	582
SOFT FACE HAMMERS & MALLETS	583
Tree Felling & Forestry Tools	585-588
AXES, HATCHETS & MAULS	586
WEDGES	587
Cold Chisels & Punches	589-596
COLD CHISELS	590
COLD CHISELS WITH GUARD	591
COLD CHISELS, REGRINDABLE	591
COLD CHISELS ACCESSORIES	592
PUNCHES	592
PUNCHES WITH 2-COMPONENT HANDLE	596
COLD CHISELS WITH 2-COMPONENT HANDLE	596
Pry Bars	597-600
WRECKING BARS	598
Planting & Cultivating Tools	601-604
SMALL GARDEN TOOLS	602
Pruning Tools	605-622
SECATEURS	606
FRUIT PICKING TOOLS	610
LOPPERS	611
POLE SAWS & TOP PRUNERS	613
HEDGE SHEARS	616
GRASS SHEARS	617
SCISSORS	618
BOW SAWS	618
PRUNING SAWS	620
SPARE PARTS & ACCESSORIES	621
ACCESSORIES & MAINTENANCE	622
Air Tools Outdoor	623-626
SECATEURS	624
Lindström	627-648
Kits & Sets	
JEWELLERY KITS	628
Shear Cutters	
TAPERED HEAD	628
POINTY HEAD	628
OBLIQUE HEAD	628
SHEAR CUTTERS SETS	628
Precision Screwdrivers	
ESD SAFE	629
Heavy Duty Cutters	
DIAGONAL CUTTER	629

Precision Cutters	
DIAGONAL CUTTERS	630
DIAGONAL CUTTERS, UNIQUE HEAD	631
OBLIQUE - END CUTTERS	631
ANGLE	631
PLASTIC CUTTERS	632
TIP CUTTER	632
OBLIQUE CUTTERS, UNIQUE HEAD	632
MICRO TIP CUTTERS	633
MULTIPURPOSE SHEARS	633
ACCESSORIES & SPARE PARTS	633
Precision Cutters for Hard materials	
CARBIDE CUTTERS	634
EXTRA HARDENED DIAGONAL CUTTERS	634
PERFORMANCE SPECIFIC DIAGONAL CUTTERS	634
PERFORMANCE SPECIFIC DIAGONAL CUTTERS, UNIQUE HEAD	634
Precision Holding Pliers	
FLAT NOSE	635
ROUND NOSE	635
CHAIN NOSE	635
CHAINMAILLE PLIER	635
BENT NOSE	636
SNIPE NOSE	636
SNIPE NOSE, UNIQUE HEAD	636
NEEDLE NOSE	636
Wire Strippers	
DIAGONAL CUTTERS	636
Torque Tools	
TORQUE SCREWDRIVERS	637
Tweezers	
TWEEZER SETS	637
CUTTING TWEEZERS	638
HIGH PRECISION TWEEZERS	638
PLASTIC REPLACEABLE TIP TWEEZERS	640
ESD SAFE ERGONOMIC TOUCH TWEEZERS	642
ECONOMY TWEEZERS	643
SMD TWEEZERS	644
COMPONENTS POSITIONING TWEEZERS	646
GENERAL PURPOSE TWEEZERS	646
SPARE PARTS & ACCESSORIES	646



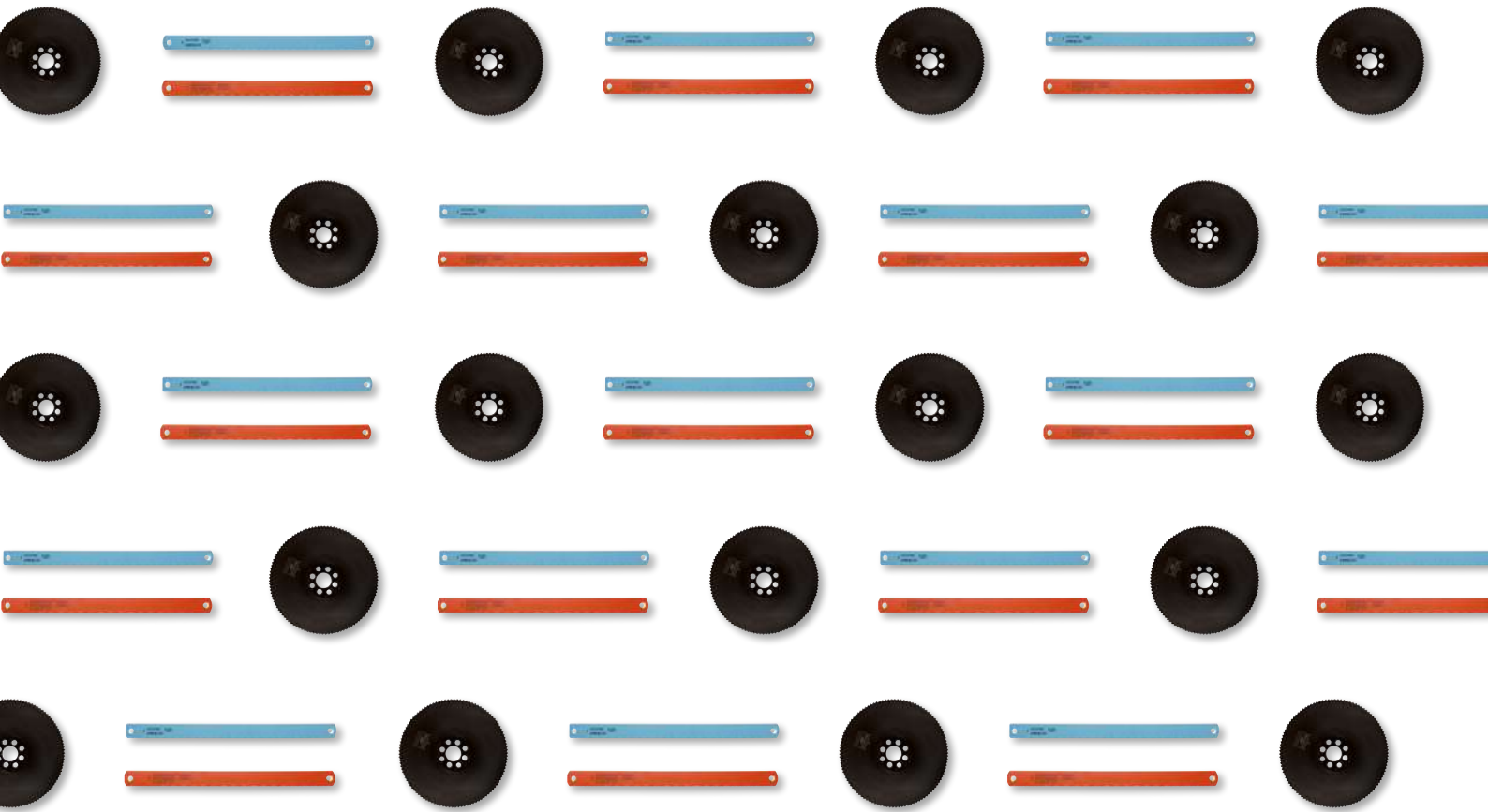

Bandsaws & Power Saws



METAL CUTTING BI-METAL BANDSAWS

Universal Bandsaw Blade for Small Workshops



3857 Easy-Cut

13 mm	EZ	1	3857-13-0.6-EZ-S
13 mm	EZ	1	3857-13-0.6-EZ-M
13 mm	EZ	1	3857-13-0.6-EZ-L
20 mm	EZ	1	3857-20-0.9-EZ-S
20 mm	EZ	1	3857-20-0.9-EZ-M
20 mm	EZ	1	3857-20-0.9-EZ-L
27 mm	EZ	1	3857-27-0.9-EZ-S
27 mm	EZ	1	3857-27-0.9-EZ-M
27 mm	EZ	1	3857-27-0.9-EZ-L
34 mm	EZ	1	3857-34-1.1-EZ-S
34 mm	EZ	1	3857-34-1.1-EZ-M
34 mm	EZ	1	3857-34-1.1-EZ-L

General Purpose Metal Cutting Bi-Metal Bandsaw Blade for Contour and Small Machines



3851 Contour and small machine

6 mm	PRX	1	3851-6-0.6-10/14
6 mm	Hook	1	3851-6-0.6-H-6
6 mm	PRX	1	3851-6-0.9-10/14
6 mm	Hook	1	3851-6-0.9-H-6
10 mm	PRX	1	3851-10-0.6-10/14
10 mm	Hook	1	3851-10-0.6-H-4
10 mm	Hook	1	3851-10-0.6-H-6
10 mm	PRX	1	3851-10-0.9-10/14
10 mm	Hook	1	3851-10-0.9-H-4
10 mm	Hook	1	3851-10-0.9-H-6
10 mm	Regular	1	3851-10-0.9-R-14
13 mm	PRX	1	3851-13-0.5-10/14

13 mm	PRX	1	3851-13-0.5-14/18
13 mm	Regular	1	3851-13-0.5-R-10
13 mm	Regular	1	3851-13-0.5-R-14
13 mm	Regular	1	3851-13-0.5-R-18
13 mm	Regular	1	3851-13-0.5-R-24
13 mm	Hook	1	3851-13-0.5-H-4
13 mm	PRX	1	3851-13-0.6-10/14
13 mm	PRX	1	3851-13-0.6-5/8
13 mm	PRX	1	3851-13-0.6-6/10
13 mm	PRX	1	3851-13-0.6-8/12
13 mm	Hook	1	3851-13-0.6-H-3
13 mm	Hook	1	3851-13-0.6-H-4
13 mm	Hook	1	3851-13-0.6-H-6
13 mm	Regular	1	3851-13-0.6-R-10
13 mm	Regular	1	3851-13-0.6-R-14
13 mm	Regular	1	3851-13-0.6-R-18
13 mm	PRX	1	3851-13-0.9-10/14
13 mm	PRX	1	3851-13-0.9-6/10
13 mm	Hook	1	3851-13-0.9-H-3
13 mm	Hook	1	3851-13-0.9-H-4
13 mm	Hook	1	3851-13-0.9-H-6
13 mm	Regular	1	3851-13-0.9-R-14
13 mm	Regular	1	3851-13-0.9-R-6
20 mm	PRX	1	3851-20-0.9-10/14
20 mm	Hook	1	3851-20-0.9-H-3
20 mm	Hook	1	3851-20-0.9-H-4
20 mm	Regular	1	3851-20-0.9-R-18
20 mm	PRX	1	3851-20-0.9-4/6
20 mm	PRX	1	3851-20-0.9-5/8
20 mm	PRX	1	3851-20-0.9-6/10
20 mm	PRX	1	3851-20-0.9-8/12
27 mm	PS	1	3851-27-0.9-P-3
27 mm	PS	1	3851-27-0.9-P-4
27 mm	Regular	1	3851-27-0.9-R-6
34 mm	PS	1	3851-34-1.1-P-2
34 mm	PS	1	3851-34-1.1-P-3

Foundry Bandsaw Blade



3851 Sandflex® Cobra™ Foundry

10 mm	HA	1	3851-10-0.6-HA-4
13 mm	HA	1	3851-13-0.6-HA-4
13 mm	HA	1	3851-13-0.6-HA-6
13 mm	HA	1	3851-13-0.9-HA-4
20 mm	HA	1	3851-20-0.9-HA-3
20 mm	HA	1	3851-20-0.9-HA-4
27 mm	HA	1	3851-27-0.9-HA-4
27 mm	HA	1	3851-27-0.9-HA-3

Production Metal Cutting Bi-Metal Bandsaw Blade for High Performance



3851 Sandflex® Cobra™

27 mm	PRX	1	3851-27-0.9-2/3
27 mm	PRX	1	3851-27-0.9-3/4
27 mm	PRX	1	3851-27-0.9-4/6
27 mm	PRX	1	3851-27-0.9-5/8
27 mm	PRX	1	3851-27-0.9-6/10
27 mm	PRX	1	3851-27-0.9-8/12
27 mm	PRX	1	3851-27-0.9-10/14
34 mm	PRX	1	3851-34-1.1-2/3
34 mm	PRX	1	3851-34-1.1-3/4
34 mm	PRX	1	3851-34-1.1-4/6
34 mm	PRX	1	3851-34-1.1-5/8
34 mm	PRX	1	3851-34-1.1-6/10
41 mm	PRX	1	3851-41-1.3-1.4/2
41 mm	PRX	1	3851-41-1.3-2/3
41 mm	PRX	1	3851-41-1.3-3/4
41 mm	PRX	1	3851-41-1.3-4/6
41 mm	PRX	1	3851-41-1.3-5/8
54 mm	PRX	1	3851-54-1.3-1.4/2
54 mm	PRX	1	3851-54-1.3-2/3
54 mm	PRX	1	3851-54-1.3-3/4
54 mm	PRX	1	3851-54-1.3-4/6
54 mm	PR	1	3851-54-1.6-P-1.25
54 mm	PRX	1	3851-54-1.6-1/1.4
54 mm	PRX	1	3851-54-1.6-1.4/2
54 mm	PRX	1	3851-54-1.6-2/3
54 mm	PRX	1	3851-54-1.6-3/4
54 mm	PRX	1	3851-54-1.6-4/6
67 mm	PRX	1	3851-67-1.6-7/1
67 mm	PRX	1	3851-67-1.6-1/1.4
67 mm	PRX	1	3851-67-1.6-1.4/2
67 mm	PRX	1	3851-67-1.6-2/3
67 mm	PRX	1	3851-67-1.6-3/4
67 mm	PRX	1	3851-67-1.6-4/6
80 mm	PRX	1	3851-80-1.6-7/1
80 mm	PRX	1	3851-80-1.6-1/1.4
80 mm	PRX	1	3851-80-1.6-1.4/2

Unique Design Bandsaw Blade for Tool Steels and Hard Materials



3854-Sandflex® King Cobra™ PHX

27 mm	PHX	1	3854-27-0.9-PHX-2/3
27 mm	PHX	1	3854-27-0.9-PHX-3/4
27 mm	PHX	1	3854-27-0.9-PHX-4/6

34 mm	PHX	1	3854-34-1.1-PHX-1.4/2
34 mm	PHX	1	3854-34-1.1-PHX-2/3
34 mm	PHX	1	3854-34-1.1-PHX-3/4
34 mm	PHX	1	3854-34-1.1-PHX-4/6
41 mm	PHX	1	3854-41-1.3-PHX-1.4/2
41 mm	PHX	1	3854-41-1.3-PHX-2/3
41 mm	PHX	1	3854-41-1.3-PHX-3/4
41 mm	PHX	1	3854-41-1.3-PHX-4/6
54 mm	PHX	1	3854-54-1.3-PHX-1.4/2
54 mm	PHX	1	3854-54-1.3-PHX-2/3
54 mm	PHX	1	3854-54-1.3-PHX-3/4
54 mm	PHX	1	3854-54-1.6-PHX-7/1
54 mm	PHX	1	3854-54-1.6-PHX-1/1.4
54 mm	PHX	1	3854-54-1.6-PHX-1.4/2
54 mm	PHX	1	3854-54-1.6-PHX-2/3
54 mm	PHX	1	3854-54-1.6-PHX-3/4
67 mm	PHX	1	3854-67-1.6-PHX-7/1
67 mm	PHX	1	3854-67-1.6-PHX-1/1.4
67 mm	PHX	1	3854-67-1.6-PHX-1.4/2
67 mm	PHX	1	3854-67-1.6-PHX-2/3
80 mm	PHX	1	3854-80-1.6-PHX-7/1
80 mm	PHX	1	3854-80-1.6-PHX-1/1.4
80 mm	PHX	1	3854-80-1.6-PHX-1.4/2

Production Metal Cutting Bi-Metal Bandsaw Blade for Special and Difficult Alloys



3854-Sandflex® King Cobra™ PQ

27 mm	PQ	1	3854-27-0.9-PQ-3/4
27 mm	PQ	1	3854-27-0.9-PQ-4/6
34 mm	PQ	1	3854-34-1.1-PQ-2/3
34 mm	PQ	1	3854-34-1.1-PQ-3/4
34 mm	PQ	1	3854-34-1.1-PQ-4/6
41 mm	PQ	1	3854-41-1.3-PQ-1.4/2
41 mm	PQ	1	3854-41-1.3-PQ-2/3
41 mm	PQ	1	3854-41-1.3-PQ-3/4
41 mm	PQ	1	3854-41-1.3-PQ-4/6
54 mm	PQ	1	3854-54-1.6-PQ-9/1.2
54 mm	PQ	1	3854-54-1.6-PQ-1.4/2
54 mm	PQ	1	3854-54-1.6-PQ-2/3
54 mm	PQ	1	3854-54-1.6-PQ-3/4
54 mm	PQ	1	3854-54-1.6-PQ-4/6
67 mm	PQ	1	3854-67-1.6-PQ-9/1.2
67 mm	PQ	1	3854-67-1.6-PQ-1.4/2
67 mm	PQ	1	3854-67-1.6-PQ-2/3
80 mm	PQ	1	3854-80-1.6-PQ-9/1.2
80 mm	PQ	1	3854-80-1.6-PQ-1.4/2



Production Metal Cutting Bi-Metal Bandsaw Blade for Special and Difficult Alloys



3858 PQ P9000

41 mm	PQ	1	3858-41-1.3-PQ-1.4/2
41 mm	PQ	1	3858-41-1.3-PQ-2/3
41 mm	PQ	1	3858-41-1.3-PQ-3/4
54 mm	PQ	1	3858-54-1.6-PQ-9/1.2
54 mm	PQ	1	3858-54-1.6-PQ-1.4/2
54 mm	PQ	1	3858-54-1.6-PQ-2/3
67 mm	PQ	1	3858-67-1.6-PQ-9/1.2
67 mm	PQ	1	3858-67-1.6-PQ-1.4/2
80 mm	PQ	1	3858-80-1.6-PQ-9/1.2

Unique Design Bandsaw Blade for Tool Steels and Hard Materials for Better Blade Life



3858 PHX P9000

34 mm	PHX	1	3858-34-1.1-PHX-1.4/2
34 mm	PHX	1	3858-34-1.1-PHX-2/3
34 mm	PHX	1	3858-34-1.1-PHX-3/4
41 mm	PHX	1	3858-41-1.3-PHX-1.4/2
41 mm	PHX	1	3858-41-1.3-PHX-2/3
41 mm	PHX	1	3858-41-1.3-PHX-3/4
54 mm	PHX	1	3858-54-1.3-PHX-1.4/2
54 mm	PHX	1	3858-54-1.3-PHX-2/3
54 mm	PHX	1	3858-54-1.3-PHX-3/4
54 mm	PHX	1	3858-54-1.6-PHX-7/1
54 mm	PHX	1	3858-54-1.6-PHX-1/1.4
54 mm	PHX	1	3858-54-1.6-PHX-1.4/2
54 mm	PHX	1	3858-54-1.6-PHX-2/3
54 mm	PHX	1	3858-54-1.6-PHX-3/4
67 mm	PHX	1	3858-67-1.6-PHX-7/1
67 mm	PHX	1	3858-67-1.6-PHX-1/1.4
67 mm	PHX	1	3858-67-1.6-PHX-1.4/2
67 mm	PHX	1	3858-67-1.6-PHX-2/3
80 mm	PHX	1	3858-80-1.6-PHX-7/1
80 mm	PHX	1	3858-80-1.6-PHX-1/1.4
80 mm	PHX	1	3858-80-1.6-PHX-1.4/2

Sandflex® Top Fabricator Bandsaw Blades



3853 Sandflex® Top Fabricator

20 mm	PF	1	3853-20-0.9-5/7-VS
20 mm	PF	1	3853-20-0.9-8/11-VS
27 mm	PF	1	3853-27-0.9-3/4
27 mm	PF	1	3853-27-0.9-4/6
27 mm	PF	1	3853-27-0.9-5/8
27 mm	PF	1	3853-27-0.9-5/7-VS
27 mm	PF	1	3853-27-0.9-8/11-VS
34 mm	PF	1	3853-34-1.1-2/3
34 mm	PF	1	3853-34-1.1-3/4
34 mm	PF	1	3853-34-1.1-4/6
34 mm	PF	1	3853-34-1.1-5/8
34 mm	PF	1	3853-34-1.1-5/7-VS
34 mm	PF	1	3853-34-1.1-8/11-VS
41 mm	PF	1	3853-41-1.3-2/3
41 mm	PF-W	1	3853-41-1.3-2/3-W
41 mm	PF	1	3853-41-1.3-3/4
41 mm	PF-W	1	3853-41-1.3-3/4-W
41 mm	PF	1	3853-41-1.3-4/6
41 mm	PF	1	3853-41-1.3-5/8
41 mm	PF	1	3853-41-1.3-5/7-VS
54 mm	PF	1	3853-54-1.3-3/4
54 mm	PF	1	3853-54-1.3-3/4-W
54 mm	PF	1	3853-54-1.3-5/8
54 mm	PF	1	3853-54-1.6-2/3
54 mm	PF-W	1	3853-54-1.6-2/3-W
54 mm	PF	1	3853-54-1.6-3/4
54 mm	PF-W	1	3853-54-1.6-3/4-W
54 mm	PF	1	3853-54-1.6-4/6
67 mm	PF	1	3853-67-1.6-2/3
67 mm	PF-W	1	3853-67-1.6-2/3-W
67 mm	PF	1	3853-67-1.6-3/4
67 mm	PF-W	1	3853-67-1.6-3/4-W
67 mm	PF-W	1	3853-67-1.6-5/8-W

Sandflex® Top Fabricator Coated Bandsaw Blades



3853 Sandflex® Top Fabricator Coated

41 mm	PF	1	3853-41-1.3-2/3-WS
41 mm	PF	1	3853-41-1.3-3/4-WS
54 mm	PF	1	3853-54-1.6-2/3-WS
54 mm	PF	1	3853-54-1.6-3/4-WS
67 mm	PF	1	3853-67-1.6-2/3-WS
67 mm	PF	1	3853-67-1.6-3/4-WS

METAL CUTTING TRI-METAL BANDSAWS

Extreme Easy-Cut Carbide Bandsaw Blades

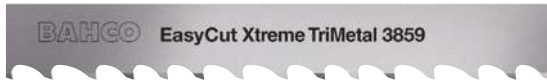

3859 Carbide Easy-Cut EZX

Width	Grade	Quantity	Part Number
27 mm	EZX	1	3859-27-0.9-EZX-3/4
27 mm	EZX	1	3859-27-0.9-EZX-4/6
34 mm	EZX	1	3859-34-1.1-EZX-2/3
34 mm	EZX	1	3859-34-1.1-EZX-3/4
34 mm	EZX	1	3859-34-1.1-EZX-4/6
41 mm	EZX	1	3859-41-1.3-EZX-1.4/2
41 mm	EZX	1	3859-41-1.3-EZX-2/3
41 mm	EZX	1	3859-41-1.3-EZX-3/4
41 mm	EZX	1	3859-41-1.3-EZX-4/6
54 mm	EZX	1	3859-54-1.6-EZX-1.4/2
54 mm	EZX	1	3859-54-1.6-EZX-1/1.25
54 mm	EZX	1	3859-54-1.6-EZX-2/3
54 mm	EZX	1	3859-54-1.6-EZX-3/4
54 mm	EZX	1	3859-54-1.6-EZX-4/6
67 mm	EZX	1	3859-67-1.6-EZX-7/11
67 mm	EZX	1	3859-67-1.6-EZX-1.4/2
67 mm	EZX	1	3859-67-1.6-EZX-1/1.25
67 mm	EZX	1	3859-67-1.6-EZX-2/3
80 mm	EZX	1	3859-80-1.6-EZX-7/11
80 mm	EZX	1	3859-80-1.6-EZX-1.4/2
80 mm	EZX	1	3859-80-1.6-EZX-1/1.25

Versatile Carbide Bandsaw Blade



3868 Carbide Triple Set® TSX

Width	Grade	Quantity	Part Number
27 mm	TSX	1	3868-27-0.9-TSX-3/4
34 mm	TSX	1	3868-34-1.1-TSX-2
34 mm	TSX	1	3868-34-1.1-TSX-2/3
34 mm	TSX	1	3868-34-1.1-TSX-3/4
41 mm	TSX	1	3868-41-1.3-TSX-1.4/2
41 mm	TSX	1	3868-41-1.3-TSX-1.6
41 mm	TSX	1	3868-41-1.3-TSX-2
41 mm	TSX	1	3868-41-1.3-TSX-2/3
41 mm	TSX	1	3868-41-1.3-TSX-3/4
54 mm	TSX	1	3868-54-1.3-TSX-1.4/2
54 mm	TSX	1	3868-54-1.3-TSX-2/3
54 mm	TSX	1	3868-54-1.6-TSX-1/1.25
54 mm	TSX	1	3868-54-1.6-TSX-1.4/2
54 mm	TSX	1	3868-54-1.6-TSX-1.6
54 mm	TSX	1	3868-54-1.6-TSX-2/3
54 mm	TSX	1	3868-54-1.6-TSX-3/4
67 mm	TSX	1	3868-67-1.6-TSX-7/11
67 mm	TSX	1	3868-67-1.6-TSX-1/1.25
67 mm	TSX	1	3868-67-1.6-TSX-1.4/2
67 mm	TSX	1	3868-67-1.6-TSX-2/3
80 mm	TSX	1	3868-80-1.1-TSX-3/4
80 mm	TSX	1	3868-80-1.6-TSX-7/11
80 mm	TSX	1	3868-80-1.6-TSX-1/1.25
80 mm	TSX	1	3868-80-1.6-TSX-1.4/2
80 mm	TSX	1	3868-80-1.6-TSX-2/3

METAL CUTTING CARBIDE BANDSAWS

Foundry Bandsaw Blade



3869 Carbide Triple Set®

Width	Grade	Quantity	Part Number
13 mm	TS	1	3869-13-0.9-TS-3
20 mm	TS	1	3869-20-0.9-TS-3
20 mm	TS	1	3869-20-0.9-TS-4
27 mm	TS	1	3869-27-0.9-TS-3
27 mm	TS	1	3869-27-0.9-TS-4
34 mm	TS	1	3869-34-1.1-TS-2
34 mm	TS	1	3869-34-1.1-TS-3

Versatile Honed Carbide Bandsaw Blade



3868 Carbide Triple Set® TSS

Width	Grade	Quantity	Part Number
27 mm	TSS	1	3868-27-0.9-TSS-3/4
34 mm	TSS	1	3868-34-1.1-TSS-2/3
34 mm	TSS	1	3868-34-1.1-TSS-3/4
41 mm	TSS	1	3868-41-1.3-TSS-1.4/2
41 mm	TSS	1	3868-41-1.3-TSS-2/3
54 mm	TSS	1	3868-54-1.6-TSS-1/1.25
54 mm	TSS	1	3868-54-1.6-TSS-1.4/2
54 mm	TSS	1	3868-54-1.6-TSS-2/3
67 mm	TSS	1	3868-67-1.6-TSS-7/11
67 mm	TSS	1	3868-67-1.6-TSS-1/1.25
67 mm	TSS	1	3868-67-1.6-TSS-1.4/2
67 mm	TSS	1	3868-67-1.6-TSS-2/3
80 mm	TSS	1	3868-80-1.6-TSS-7/11
80 mm	TSS	1	3868-80-1.6-TSS-1.4/2
80 mm	TSS	1	3868-80-1.6-TSS-2/3



Advanced Carbide Bandsaw Blade



3881 Carbide Multi Set THQ

34 mm	THQ	1	3881-34-1.1-THQ-2/3
41 mm	THQ	1	3881-41-1.3-THQ-1.4/2
41 mm	THQ	1	3881-41-1.3-THQ-2/3
54 mm	THQ	1	3881-54-1.6-THQ-1.4/2
54 mm	THQ	1	3881-54-1.6-THQ-1/1.25
54 mm	THQ	1	3881-54-1.6-THQ-2/3
67 mm	THQ	1	3881-67-1.6-THQ-1/1.25
67 mm	THQ	1	3881-67-1.6-THQ-1.4/2
67 mm	THQ	1	3881-67-1.6-THQ-2/3
80 mm	THQ	1	3881-80-1.6-THQ-7/1
80 mm	THQ	1	3881-80-1.6-THQ-1/1.25
80 mm	THQ	1	3881-80-1.6-THQ-1.4/2
80 mm	THQ	1	3881-80-1.6-THQ-2/3

Advanced Honed Carbide Bandsaw Blade



3881 Carbide Multi Set THS

41 mm	THS	1	3881-41-1.3-THS-1.4/2
54 mm	THS	1	3881-54-1.6-THS-1/1.25
54 mm	THS	1	3881-54-1.6-THS-1.4/2
67 mm	THS	1	3881-67-1.6-THS-1/1.25
67 mm	THS	1	3881-67-1.6-THS-1.4/2
67 mm	THS	1	3881-67-1.6-THS-2/3
80 mm	THS	1	3881-80-1.6-THS-7/1
80 mm	THS	1	3881-80-1.6-THS-1.4/2
80 mm	THS	1	3881-80-1.6-THS-2/3
100 mm	THS	1	3881-100-1.6-THS-7/1

Most Advanced Carbide Bandsaw Blade



3860 Unset Carbide TMC

41 mm	TMC	1	3860-41-1.3-TMC-1.4/2
41 mm	TMC	1	3860-41-1.3-TMC-2/3
54 mm	TMC	1	3860-54-1.3-TMC-1.4/2
54 mm	TMC	1	3860-54-1.3-TMC-2/3
54 mm	TMC	1	3860-54-1.6-TMC-7/1
54 mm	TMC	1	3860-54-1.6-TMC-1/1.25
54 mm	TMC	1	3860-54-1.6-TMC-1.4/2
54 mm	TMC	1	3860-54-1.6-TMC-2/3
67 mm	TMC	1	3860-67-1.6-TMC-1/1.25
67 mm	TMC	1	3860-67-1.6-TMC-1.4/2
67 mm	TMC	1	3860-67-1.6-TMC-2/3
80 mm	TMC	1	3860-80-1.1-TMC-1.4/2
80 mm	TMC	1	3860-80-1.6-TMC-7/1
80 mm	TMC	1	3860-80-1.6-TMC-1/1.25
80 mm	TMC	1	3860-80-1.6-TMC-1.4/2
80 mm	TMC	1	3860-80-1.6-TMC-2/3
100 mm	TMC	1	3860-100-1.1-TMC-1.4/2

Versatile Carbide Bandsaw Blade



3860 Unset Carbide TCD

27 mm	TCD	1	3860-27-0.9-TCD-3
27 mm	TCD	1	3860-27-0.9-TCD-3/4
34 mm	TCD	1	3860-34-1.1-TCD-2/3
34 mm	TCD	1	3860-34-1.1-TCD-3/4
34 mm	TCD	1	3860-34-1.1-TCD-3/4-W
41 mm	TCD	1	3860-41-1.3-TCD-1.4/2
41 mm	TCD	1	3860-41-1.3-TCD-1.9/2.1
41 mm	TCD	1	3860-41-1.3-TCD-2/3
41 mm	TCD	1	3860-41-1.3-TCD-3/4
54 mm	TCD	1	3860-54-1.6-TCD-1.4/2
54 mm	TCD	1	3860-54-1.6-TCD-1.9/2.1
54 mm	TCD	1	3860-54-1.6-TCD-2/3
54 mm	TCD	1	3860-54-1.6-TCD-3/4
67 mm	TCD	1	3860-67-1.6-TCD-1.4/2
67 mm	TCD	1	3860-67-1.6-TCD-1/1.25
80 mm	TCD	1	3860-80-1.6-TCD-5/0.8

Bandsaw Blade for Induction Hardened Bars



3860 Unset Carbide TCZ



27 mm	TCZ	1	3860-27-0.9-TCZ-3/4
34 mm	TCZ	1	3860-34-1.1-TCZ-2/3
34 mm	TCZ	1	3860-34-1.1-TCZ-3/4
41 mm	TCZ	1	3860-41-1.3-TCZ-2/3
41 mm	TCZ	1	3860-41-1.3-TCZ-3/4

3860 TCA - Unset Carbide Bandsaw



3860 Unset Carbide TCA



27 mm	TCA	1	3860-27-0.9-TCA-3
34 mm	TCA	1	3860-34-1.1-TCA-2/3
34 mm	TCA	1	3860-34-1.1-TCA-3
41 mm	TCA	1	3860-41-1.3-TCA-1.4/2
41 mm	TCA	1	3860-41-1.3-TCA-2/3
54 mm	TCA	1	3860-54-1.6-TCA-.8/1
54 mm	TCA	1	3860-54-1.6-TCA-1/1.25
54 mm	TCA	1	3860-54-1.6-TCA-1.4/2
80 mm	TCA	1	3860-80-1.6-TCA-.8/1

Coated TMC Multi Chip Unset Carbide Bandsaw Blades



3860 Unset Carbide TMC Coated



54 mm	TMC	1	3860-54-1.6-TMC-1/1.25S
54 mm	TMC	1	3860-54-1.6-TMC-1.4/2S
54 mm	TMC	1	3860-54-1.6-TMC-2/3S
67 mm	TMC	1	3860-67-1.6-TMC-1/1.25S
67 mm	TMC	1	3860-67-1.6-TMC-1.4/2S

WOOD CUTTING BANDSAW

Bi-metal Bandsaw Blade for Longer Life



3861 Sandcut Bi-metal

4	Hook	1	3861-20-0.6-H-4
1.33	Hook	1	3861-27-0.9-H-1.33
1.15	Hook	1	3861-34-0.9-H-1.15
1.15	Hook	1	3861-34-1.1-H-1.15
1.15	Hook	1	3861-41-1.1-H-1.15
1.15	Hook	1	3861-54-1.1-H-1.15



Standard Bandsaw Blade



3862 Sandcut Solid

1.15	Hook	1	3862-33-0.9-H-1.15
1.15	Hook	1	3862-33-1.1-H-1.15
1.15	Hook	1	3862-40-1.1-H-1.15

INSULATION CUTTING BANDSAWS

Sandflex® Twin Tip Insulation Bandsaw Blades



3852 Sandflex® Twin Tip Insulation

27 mm	INS	1	3852-27-0.9-INS-3
34 mm	INS	1	3852-34-1.1-INS-3

HSS CIRCULAR SAWBLADES

HSS Circular Saw Blades with 32-1 Bore



3815-32-1

200 mm	BW3	1	3815-200-2.0-32-1-03BW
200 mm	BW4	1	3815-200-2.0-32-1-04BW
225 mm	BW3	1	3815-225-2.0-32-1-03BW
225 mm	BW4	1	3815-225-2.0-32-1-04BW

225 mm	BW5	1	3815-225-2.0-32-1-05BW
225 mm	C6	1	3815-225-2.0-32-1-06C
250 mm	BW3	1	3815-250-2.0-32-1-03BW
250 mm	BW4	1	3815-250-2.0-32-1-04BW
250 mm	BW5	1	3815-250-2.0-32-1-05BW
250 mm	C6	1	3815-250-2.0-32-1-06C
275 mm	BW4	1	3815-275-2.5-32-1-04BW
275 mm	BW5	1	3815-275-2.5-32-1-05BW
275 mm	C6	1	3815-275-2.5-32-1-06C
275 mm	C8	1	3815-275-2.5-32-1-08C
300 mm	BW4	1	3815-300-2.5-32-1-04BW
300 mm	BW5	1	3815-300-2.5-32-1-05BW
300 mm	C5	1	3815-300-2.5-32-1-05C
300 mm	C6	1	3815-300-2.5-32-1-06C
300 mm	C8	1	3815-300-2.5-32-1-08C
315 mm	BW4	1	3815-315-2.5-32-1-04BW
315 mm	BW5	1	3815-315-2.5-32-1-05BW
315 mm	C6	1	3815-315-2.5-32-1-06C
315 mm	C8	1	3815-315-2.5-32-1-08C
350 mm	BW4	1	3815-350-2.5-32-1-04BW
350 mm	C6	1	3815-350-2.5-32-1-06C

HSS Circular Saw Blades with 40-2 Bore



3815-40-2

250 mm	BW3	1	3815-250-2.0-40-2-03BW
250 mm	BW4	1	3815-250-2.0-40-2-04BW
250 mm	BW5	1	3815-250-2.0-40-2-05BW
275 mm	BW3	1	3815-275-2.5-40-2-03BW
275 mm	BW4	1	3815-275-2.5-40-2-04BW
275 mm	BW5	1	3815-275-2.5-40-2-05BW
275 mm	C6	1	3815-275-2.5-40-2-06C
275 mm	C8	1	3815-275-2.5-40-2-08C
315 mm	BW4	1	3815-315-2.5-40-2-04BW
315 mm	BW5	1	3815-315-2.5-40-2-05BW
315 mm	C6	1	3815-315-3.0-40-2-06C

HSS Circular Saw Blades with 50-4 Bore



3815-50-4

370 mm	C8	1	3815-370-3.0-50-4-08C
370 mm	C10	1	3815-370-3.0-50-4-10C
400 mm	C10	1	3815-400-3.5-50-4-10C

8	350 mm	10	3809-350-32-1.60-8
10	350 mm	10	3809-350-32-1.60-10
14	350 mm	10	3809-350-32-1.60-14
4	350 mm	10	3809-350-32-2.00-4
6	350 mm	10	3809-350-32-2.00-6
10	350 mm	10	3809-350-32-2.00-10
6	350 mm	10	3809-350-38-2.00-6
10	350 mm	10	3809-350-38-2.00-10
10	400 mm	10	3809-400-25-1.25-10
4	400 mm	10	3809-400-32-1.60-4
6	400 mm	10	3809-400-32-1.60-6
8	400 mm	10	3809-400-32-1.60-8
10	400 mm	10	3809-400-32-1.60-10
14	400 mm	10	3809-400-32-1.60-14
4	400 mm	10	3809-400-32-2.00-4
6	400 mm	10	3809-400-32-2.00-6
8	400 mm	10	3809-400-32-2.00-8
10	400 mm	10	3809-400-32-2.00-10
4	400 mm	10	3809-400-38-2.00-4
6	400 mm	10	3809-400-38-2.00-6
10	400 mm	10	3809-400-38-2.00-10
6	425 mm	10	3809-425-32-1.60-6
10	425 mm	10	3809-425-32-1.60-10
4	450 mm	10	3809-450-32-1.60-4
6	450 mm	10	3809-450-32-1.60-6
10	450 mm	10	3809-450-32-1.60-10
14	450 mm	10	3809-450-32-1.60-14
4	450 mm	10	3809-450-32-2.00-4
6	450 mm	10	3809-450-32-2.00-6
10	450 mm	10	3809-450-32-2.00-10
4	450 mm	10	3809-450-38-2.00-4
6	450 mm	10	3809-450-38-2.00-6
8	450 mm	10	3809-450-38-2.00-8
10	450 mm	10	3809-450-38-2.00-10
4	450 mm	10	3809-450-45-2.25-4
6	450 mm	10	3809-450-45-2.25-6
6	475 mm	10	3809-475-45-2.25-6
4	500 mm	10	3809-500-38-2.00-4
6	500 mm	10	3809-500-38-2.00-6
10	500 mm	10	3809-500-38-2.00-10
4	500 mm	10	3809-500-45-2.25-4
6	500 mm	10	3809-500-45-2.25-6
4	500 mm	10	3809-500-50-2.50-4
6	500 mm	10	3809-500-50-2.50-6
8	500 mm	10	3809-500-50-2.50-8
6	525 mm	10	3809-525-38-2.00-6
10	525 mm	10	3809-525-38-2.00-10
4	525 mm	10	3809-525-45-2.25-4
6	525 mm	10	3809-525-45-2.25-6
4	550 mm	10	3809-550-45-2.25-4
6	550 mm	10	3809-550-45-2.25-6
4	550 mm	10	3809-550-50-2.50-4
6	550 mm	10	3809-550-50-2.50-6
4	575 mm	10	3809-575-45-2.25-4
3	575 mm	10	3809-575-50-2.50-3
4	575 mm	10	3809-575-50-2.50-4
6	575 mm	10	3809-575-50-2.50-6
6	600 mm	10	3809-600-38-2.00-6
4	600 mm	10	3809-600-45-2.25-4
6	600 mm	10	3809-600-45-2.25-6
3	600 mm	10	3809-600-50-2.50-3
4	600 mm	10	3809-600-50-2.50-4
6	600 mm	10	3809-600-50-2.50-6
4	650 mm	5	3809-650-50-2.50-4
6	650 mm	5	3809-650-50-2.50-6
4	700 mm	5	3809-700-50-2.50-4
6	700 mm	5	3809-700-50-2.50-6
4	750 mm	5	3809-750-50-2.50-4
6	750 mm	5	3809-750-50-2.50-6

POWER HACKSAW BLADES

Sandflex® Bi-Metal Power Hacksaw Blades

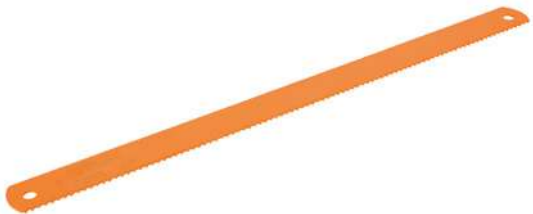

3809





10	300 mm	10	3809-300-25-1.25-10
14	300 mm	10	3809-300-25-1.25-14
6	300 mm	10	3809-300-32-1.60-6
10	300 mm	10	3809-300-32-1.60-10
6	350 mm	10	3809-350-25-1.25-6
10	350 mm	10	3809-350-25-1.25-10
14	350 mm	10	3809-350-25-1.25-14
4	350 mm	10	3809-350-32-1.60-4
6	350 mm	10	3809-350-32-1.60-6







Sandflex® Bi-metal Power Hacksaw Blades for KASTO machines



3809 KA



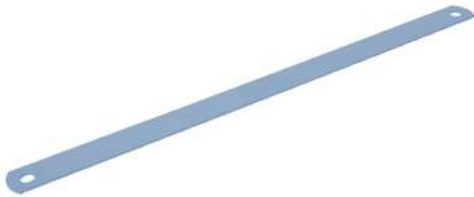

			
6	400 mm	10	3809-400-32-2.00-6-KA
4	450 mm	10	3809-450-38-2.00-4-KA
6	450 mm	10	3809-450-38-2.00-6-KA
10	450 mm	10	3809-450-38-2.00-10-KA
6	500 mm	10	3809-500-45-2.25-6-KA
4	500 mm	10	3809-500-50-2.50-4-KA
6	500 mm	10	3809-500-50-2.50-6-KA
4	550 mm	10	3809-550-50-2.50-4-KA
6	550 mm	10	3809-550-50-2.50-6-KA
3	575 mm	10	3809-575-50-2.50-3-KA
4	575 mm	10	3809-575-50-2.50-4-KA
6	575 mm	10	3809-575-50-2.50-6-KA
10	575 mm	10	3809-575-50-2.50-10-KA
4	600 mm	10	3809-600-50-2.50-4-KA
6	600 mm	10	3809-600-50-2.50-6-KA
3	650 mm	5	3809-650-50-2.50-3-KA
4	650 mm	5	3809-650-50-2.50-4-KA
6	650 mm	5	3809-650-50-2.50-6-KA
3	700 mm	5	3809-700-50-2.50-3-KA
4	700 mm	5	3809-700-50-2.50-4-KA
6	700 mm	5	3809-700-50-2.50-6-KA

			
8	400 mm	10	3802-400-32-1.60-8
10	400 mm	10	3802-400-32-1.60-10
14	400 mm	10	3802-400-32-1.60-14
4	400 mm	10	3802-400-38-2.00-4
6	400 mm	10	3802-400-38-2.00-6
10	400 mm	10	3802-400-38-2.00-10
6	425 mm	10	3802-425-32-1.60-6
10	425 mm	10	3802-425-32-1.60-10
4	450 mm	10	3802-450-32-1.60-4
6	450 mm	10	3802-450-32-1.60-6
10	450 mm	10	3802-450-32-1.60-10
14	450 mm	10	3802-450-32-1.60-14
4	450 mm	10	3802-450-38-2.00-4
6	450 mm	10	3802-450-38-2.00-6
8	450 mm	10	3802-450-38-2.00-8
10	450 mm	10	3802-450-38-2.00-10
8	475 mm	10	3802-475-38-2.00-8
4	500 mm	10	3802-500-38-2.00-4
6	500 mm	10	3802-500-38-2.00-6
8	500 mm	10	3802-500-38-2.00-8
10	500 mm	10	3802-500-38-2.00-10
10	500 mm	10	3802-500-45-2.25-10
4	500 mm	10	3802-500-50-2.50-4
6	500 mm	10	3802-500-50-2.50-6
6	525 mm	10	3802-525-38-2.00-6
8	525 mm	10	3802-525-38-2.00-8
10	525 mm	10	3802-525-38-2.00-10
6	550 mm	10	3802-550-38-2.00-6
4	550 mm	10	3802-550-50-2.50-4
6	550 mm	10	3802-550-50-2.50-6
8	550 mm	5	3802-550-50-2.50-8
10	550 mm	10	3802-550-50-2.50-10
4	575 mm	10	3802-575-50-2.50-4
6	575 mm	10	3802-575-50-2.50-6
4	600 mm	10	3802-600-50-2.50-4
6	600 mm	10	3802-600-50-2.50-6
8	600 mm	10	3802-600-50-2.50-8
4	650 mm	5	3802-650-50-2.50-4
6	650 mm	5	3802-650-50-2.50-6
3	700 mm	5	3802-700-50-2.50-3
4	700 mm	5	3802-700-50-2.50-4
6	700 mm	5	3802-700-50-2.50-6
4	750 mm	5	3802-750-50-2.50-4
6	750 mm	5	3802-750-50-2.50-6

HSS Power Hacksaw Blades







3802

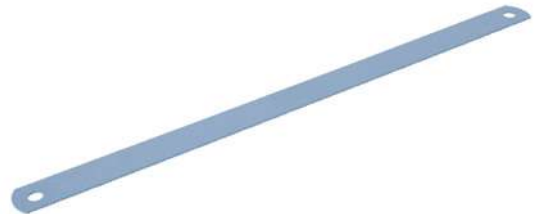



			
6	300 mm	10	3802-300-25-1.25-6
10	300 mm	10	3802-300-25-1.25-10
14	300 mm	10	3802-300-25-1.25-14
6	300 mm	10	3802-300-32-1.60-6
10	300 mm	10	3802-300-32-1.60-10
6	350 mm	10	3802-350-25-1.25-6
10	350 mm	10	3802-350-25-1.25-10
14	350 mm	10	3802-350-25-1.25-14
4	350 mm	10	3802-350-32-1.60-4
6	350 mm	10	3802-350-32-1.60-6
8	350 mm	10	3802-350-32-1.60-8
10	350 mm	10	3802-350-32-1.60-10
14	350 mm	10	3802-350-32-1.60-14
6	400 mm	10	3802-400-25-1.25-6
10	400 mm	10	3802-400-25-1.25-10
14	400 mm	10	3802-400-25-1.25-14
4	400 mm	10	3802-400-32-1.60-4
6	400 mm	10	3802-400-32-1.60-6

HSS Power Hacksaw Blades for KASTO machines



3802 KA

			
4	450 mm	10	3802-450-38-2.00-4-KA
6	450 mm	10	3802-450-38-2.00-6-KA
8	450 mm	10	3802-450-38-2.00-8-KA
10	450 mm	10	3802-450-38-2.00-10-KA
4	500 mm	10	3802-500-50-2.50-4-KA
6	500 mm	10	3802-500-50-2.50-6-KA
4	550 mm	10	3802-550-50-2.50-4-KA
8	550 mm	10	3802-550-50-2.50-8-KA
3	575 mm	10	3802-575-50-2.50-3-KA
4	575 mm	10	3802-575-50-2.50-4-KA



			
6	575 mm	10	3802-575-50-2.50-6-KA
4	650 mm	5	3802-650-50-2.50-4-KA
6	650 mm	5	3802-650-50-2.50-6-KA
2	700 mm	5	3802-700-50-2.50-2-KA
4	700 mm	5	3802-700-50-2.50-4-KA
6	700 mm	5	3802-700-50-2.50-6-KA

BANDSAW ACCESSORIES

Chip Brushes for Cleaning Bandsaw Blade



3870-BRUSH

		
60 mm	4	3870-BRUSH-60-6
80 mm	4	3870-BRUSH-80-6
80 mm	4	3870-BRUSH-80-8
80 mm	4	3870-BRUSH-80-10
100 mm	4	3870-BRUSH-100-10
100 mm	4	3870-BRUSH-100-12
100 mm	4	3870-BRUSH-100-10-HEX
100 mm	1	3870-BRUSH-100-13

Tension Meters for Bandsaw



3870-TENSION

		
680 g	1	3870-TENSION METER

Refractometers for Bandsaw



3870-REFR

		
260 g	1	3870-REFRACTOMETER

Steel Wedges 75 mm



3870-WEDGE

		
60 g	1	3870-WEDGE-3

Bandsaw Tension Adjusting Wheel



3870-Wheel

		
0.7790 kg	1	3870-WHEEL





BAHCO®



Files



ENGINEERING FILES

Engineering Flat Hand Files Bastard/
Second/Smooth Cut Unhandled



1-100...-0

Length	Type of cut	Quantity	Part Number
100 mm	1	10	1-100-04-1-0
100 mm	2	10	1-100-04-2-0
100 mm	3	10	1-100-04-3-0
150 mm	1	10	1-100-06-1-0
150 mm	2	10	1-100-06-2-0
150 mm	3	10	1-100-06-3-0
200 mm	1	10	1-100-08-1-0
200 mm	2	10	1-100-08-2-0
200 mm	3	10	1-100-08-3-0
250 mm	1	10	1-100-10-1-0
250 mm	2	10	1-100-10-2-0
250 mm	3	10	1-100-10-3-0
300 mm	1	5	1-100-12-1-0
300 mm	2	5	1-100-12-2-0
300 mm	3	5	1-100-12-3-0
350 mm	1	5	1-100-14-1-0
350 mm	2	5	1-100-14-2-0

Type of cut: 1 = Bastard, 2 = Second, 3 = Smooth

ERGO™ Engineering Flat Hand Files
Bastard/Second/Smooth Cut



ergo



1-100...-2

Length	Type of cut	Quantity	Part Number
100 mm	1	5	1-100-04-1-2
100 mm	2	5	1-100-04-2-2
150 mm	1	5	1-100-06-1-2
150 mm	2	5	1-100-06-2-2
150 mm	3	5	1-100-06-3-2
200 mm	1	5	1-100-08-1-2
200 mm	2	5	1-100-08-2-2
200 mm	3	5	1-100-08-3-2
250 mm	1	5	1-100-10-1-2
250 mm	2	5	1-100-10-2-2
250 mm	3	5	1-100-10-3-2
300 mm	1	5	1-100-12-1-2
300 mm	2	5	1-100-12-2-2
300 mm	3	5	1-100-12-3-2

Type of cut: 1 = Bastard, 2 = Second, 3 = Smooth

Engineering Pillar Files Bastard/Second/
Smooth Cut Unhandled



1-102

Length	Type of cut	Quantity	Part Number
150 mm	2	10	1-102-06-2-0
150 mm	3	10	1-102-06-3-0
200 mm	1	10	1-102-08-1-0
200 mm	2	10	1-102-08-2-0
200 mm	3	10	1-102-08-3-0

Type of cut: 1 = Bastard, 2 = Second, 3 = Smooth

Engineering Lathe Files Second/Smooth
Cut Unhandled



1-104

Length	Type of cut	Quantity	Part Number
250 mm	2	10	1-104-10-2-0
250 mm	3	10	1-104-10-3-0
300 mm	2	5	1-104-12-2-0
300 mm	3	5	1-104-12-3-0
350 mm	3	5	1-104-14-3-0

Type of cut: 1 = Bastard, 2 = Second, 3 = Smooth

Engineering Oberg Cut Flat Hand Files
Bastard Cut Unhandled



1-106...-0

Length	Type of cut	Quantity	Part Number
200 mm	1	10	1-106-08-1-0
250 mm	1	10	1-106-10-1-0
300 mm	1	5	1-106-12-1-0

Type of cut: 1 = Bastard, 2 = Second, 3 = Smooth

ERGO™ Engineering Oberg Cut Flat Hand
Files Bastard Cut



ergo



1-106...-2

Length	Type of cut	Quantity	Part Number
200 mm	1	5	1-106-08-1-2
250 mm	1	5	1-106-10-1-2
300 mm	1	5	1-106-12-1-2

Type of cut: 1 = Bastard, 2 = Second, 3 = Smooth

Engineering Flat Files with Tapered Edge
Bastard/Second/Smooth Cut Unhandled



1-110...-0

Length	Type of cut	Quantity	Part Number
100 mm	1	10	1-110-04-1-0
100 mm	2	10	1-110-04-2-0
100 mm	3	10	1-110-04-3-0
150 mm	1	10	1-110-06-1-0
150 mm	2	10	1-110-06-2-0
150 mm	3	10	1-110-06-3-0
200 mm	1	10	1-110-08-1-0
200 mm	2	10	1-110-08-2-0
200 mm	3	10	1-110-08-3-0
250 mm	1	10	1-110-10-1-0
250 mm	2	10	1-110-10-2-0
250 mm	3	10	1-110-10-3-0
300 mm	1	5	1-110-12-1-0
300 mm	2	5	1-110-12-2-0
300 mm	3	5	1-110-12-3-0
350 mm	1	5	1-110-14-1-0

Type of cut: 1 = Bastard, 2 = Second, 3 = Smooth

ERGO™ Engineering Tapered Edge Flat File Bastard/Second/Smooth Cut



1-110...-2



150 mm	1	5	1-110-06-1-2
150 mm	2	5	1-110-06-2-2
150 mm	3	5	1-110-06-3-2
200 mm	1	5	1-110-08-1-2
200 mm	2	5	1-110-08-2-2
200 mm	3	5	1-110-08-3-2
250 mm	1	5	1-110-10-1-2
250 mm	2	5	1-110-10-2-2
250 mm	3	5	1-110-10-3-2
300 mm	1	5	1-110-12-1-2
300 mm	2	5	1-110-12-2-2
300 mm	3	5	1-110-12-3-2

Type of cut: 1 = Bastard, 2 = Second, 3 = Smooth

Engineering Warding Flat Hand Files Bastard/Second/Smooth Cut Unhandled



1-111...-0



100 mm	1	10	1-111-04-1-0
100 mm	2	10	1-111-04-2-0
100 mm	3	10	1-111-04-3-0
150 mm	1	10	1-111-06-1-0
150 mm	2	10	1-111-06-2-0
150 mm	3	10	1-111-06-3-0
200 mm	1	10	1-111-08-1-0
200 mm	2	10	1-111-08-2-0

Type of cut: 1 = Bastard, 2 = Second, 3 = Smooth

ERGO™ Engineering Warding Flat Files Second Cut



1-111...-2



150 mm	2	5	1-111-06-2-2
--------	---	---	--------------

Type of cut: 1 = Bastard, 2 = Second, 3 = Smooth

Engineering Flat Contact Files Smooth Cut Unhandled



1-115



110 mm	3	10	1-115-11-3-1
--------	---	----	--------------

Engineering Mill Files with 2 Flat Edges Bastard/Second Cut Unhandled



1-143...-0



100 mm	1	10	1-143-04-1-0
150 mm	1	10	1-143-06-1-0
200 mm	1	10	1-143-08-1-0
250 mm	1	10	1-143-10-1-0
300 mm	1	5	1-143-12-1-0

Type of cut: 1 = Bastard, 2 = Second, 3 = Smooth

ERGO™ Engineering Mill Files with 2 Flat Edges Bastard/Second Cut



1-143...-2



150 mm	1	5	1-143-06-1-2
200 mm	1	5	1-143-08-1-2
250 mm	1	5	1-143-10-1-2
300 mm	1	5	1-143-12-1-2

Type of cut: 1 = Bastard, 2 = Second, 3 = Smooth

ERGO™ Engineering Diagonal Files Second Cut



1-320...-2



200 mm	2	5	1-320-08-2-2
250 mm	2	5	1-320-10-2-2

Type of cut: 1 = Bastard, 2 = Second, 3 = Smooth

Engineering Diagonal Files Second Cut Unhandled



1-320...-0



200 mm	2	10	1-320-08-2-0
250 mm	2	10	1-320-10-2-0
300 mm	2	5	1-320-12-2-0

Type of cut: 1 = Bastard, 2 = Second, 3 = Smooth

Engineering Half-Round Files Bastard/Second/Smooth Cut Unhandled



1-210...-0



100 mm	1	10	1-210-04-1-0
100 mm	2	10	1-210-04-2-0
100 mm	3	10	1-210-04-3-0
150 mm	1	10	1-210-06-1-0
150 mm	2	10	1-210-06-2-0
150 mm	3	10	1-210-06-3-0
200 mm	1	10	1-210-08-1-0
200 mm	2	10	1-210-08-2-0
200 mm	3	10	1-210-08-3-0
250 mm	1	10	1-210-10-1-0
250 mm	2	10	1-210-10-2-0
250 mm	3	10	1-210-10-3-0
300 mm	1	5	1-210-12-1-0
300 mm	2	5	1-210-12-2-0
300 mm	3	5	1-210-12-3-0
350 mm	1	5	1-210-14-1-0

Type of cut: 1 = Bastard, 2 = Second, 3 = Smooth



ERGO™ Engineering Half-Round Files
Bastard/Second/Smooth Cut



1-210...-2

Length	Type	Quantity	Part No.
100 mm	1	5	1-210-04-1-2
100 mm	2	5	1-210-04-2-2
150 mm	1	5	1-210-06-1-2
150 mm	2	5	1-210-06-2-2
150 mm	3	5	1-210-06-3-2
200 mm	1	5	1-210-08-1-2
200 mm	2	5	1-210-08-2-2
200 mm	3	5	1-210-08-3-2
250 mm	1	5	1-210-10-1-2
250 mm	2	5	1-210-10-2-2
250 mm	3	5	1-210-10-3-2
300 mm	1	5	1-210-12-1-2
300 mm	2	5	1-210-12-2-2
300 mm	3	5	1-210-12-3-2

Type of cut: 1 = Bastard, 2 = Second, 3 = Smooth

Engineering Round Files Bastard/Second/
Smooth Cut Unhandled



1-230...-0

Length	Type	Quantity	Part No.
100 mm	1	10	1-230-04-1-0
100 mm	2	10	1-230-04-2-0
100 mm	3	10	1-230-04-3-0
150 mm	1	10	1-230-06-1-0
150 mm	2	10	1-230-06-2-0
150 mm	3	10	1-230-06-3-0
200 mm	1	10	1-230-08-1-0
200 mm	2	10	1-230-08-2-0
200 mm	3	10	1-230-08-3-0
250 mm	1	10	1-230-10-1-0
250 mm	2	10	1-230-10-2-0
250 mm	3	10	1-230-10-3-0
300 mm	1	5	1-230-12-1-0
300 mm	2	5	1-230-12-2-0
300 mm	3	5	1-230-12-3-0

Type of cut: 1 = Bastard, 2 = Second, 3 = Smooth

ERGO™ Engineering Round Files
Bastard/Second/Smooth Cut



1-230...-2

Length	Type	Quantity	Part No.
100 mm	1	5	1-230-04-1-2
100 mm	2	5	1-230-04-2-2
150 mm	1	5	1-230-06-1-2
150 mm	2	5	1-230-06-2-2
150 mm	3	5	1-230-06-3-2
200 mm	1	5	1-230-08-1-2
200 mm	2	5	1-230-08-2-2
200 mm	3	5	1-230-08-3-2
250 mm	1	5	1-230-10-1-2
250 mm	2	5	1-230-10-2-2
250 mm	3	5	1-230-10-3-2
300 mm	1	5	1-230-12-1-2
300 mm	2	5	1-230-12-2-2
300 mm	3	5	1-230-12-3-2

Type of cut: 1 = Bastard, 2 = Second, 3 = Smooth

Engineering Three Square Files Bastard/
Second/Smooth Cut Unhandled



1-170...-0

Length	Type	Quantity	Part No.
100 mm	1	10	1-170-04-1-0
100 mm	2	10	1-170-04-2-0
100 mm	3	10	1-170-04-3-0
150 mm	1	10	1-170-06-1-0
150 mm	2	10	1-170-06-2-0
150 mm	3	10	1-170-06-3-0
200 mm	1	10	1-170-08-1-0
200 mm	2	10	1-170-08-2-0
200 mm	3	10	1-170-08-3-0
250 mm	1	10	1-170-10-1-0
250 mm	2	10	1-170-10-2-0
250 mm	3	10	1-170-10-3-0
300 mm	1	5	1-170-12-1-0
300 mm	2	5	1-170-12-2-0

Type of cut: 1 = Bastard, 2 = Second, 3 = Smooth

ERGO™ Engineering Three Square Files
Bastard/Second/Smooth Cut



1-170...-2

Length	Type	Quantity	Part No.
100 mm	2	5	1-170-04-2-2
150 mm	1	5	1-170-06-1-2
150 mm	2	5	1-170-06-2-2
150 mm	3	5	1-170-06-3-2
200 mm	1	5	1-170-08-1-2
200 mm	2	5	1-170-08-2-2
200 mm	3	5	1-170-08-3-2
250 mm	1	5	1-170-10-1-2
250 mm	2	5	1-170-10-2-2
250 mm	3	5	1-170-10-3-2

Type of cut: 1 = Bastard, 2 = Second, 3 = Smooth

Engineering Square Files Bastard/Second/
Smooth Cut Unhandled



1-160...-0

Length	Type	Quantity	Part No.
100 mm	1	10	1-160-04-1-0
100 mm	2	10	1-160-04-2-0
100 mm	3	10	1-160-04-3-0
150 mm	1	10	1-160-06-1-0
150 mm	2	10	1-160-06-2-0
150 mm	3	10	1-160-06-3-0
200 mm	1	10	1-160-08-1-0
200 mm	2	10	1-160-08-2-0
200 mm	3	10	1-160-08-3-0
250 mm	1	10	1-160-10-1-0
250 mm	2	10	1-160-10-2-0
250 mm	3	10	1-160-10-3-0
300 mm	1	5	1-160-12-1-0
300 mm	2	5	1-160-12-2-0
300 mm	3	5	1-160-12-3-0

Type of cut: 1 = Bastard, 2 = Second, 3 = Smooth

ERGO™ Engineering Square Files
Bastard/Second/Smooth Cut



1-160...-2

Length	Type	Quantity	Part No.
100 mm	1	5	1-160-04-1-2
100 mm	2	5	1-160-04-2-2
150 mm	1	5	1-160-06-1-2

150 mm	2	5	1-160-06-2-2
150 mm	3	5	1-160-06-3-2
200 mm	1	5	1-160-08-1-2
200 mm	2	5	1-160-08-2-2
200 mm	3	5	1-160-08-3-2
250 mm	1	5	1-160-10-1-2
250 mm	2	5	1-160-10-2-2
250 mm	3	5	1-160-10-3-2
300 mm	1	5	1-160-12-1-2
300 mm	2	5	1-160-12-2-2
300 mm	3	5	1-160-12-3-2

Type of cut: 1 = Bastard, 2 = Second, 3 = Smooth

ERGO™ Engineering File Set Smooth Cut - 6 Pcs



1-476

100 mm	3	1	1-476-04-3-2

1-160-04-3-2, 1-111-04-3-2, 1-230-04-3-2, 1-170-04-3-2, 1-210-04-3-2, 1-100-04-3-2

ERGO™ Engineering File Set Second Cut 150 mm - 3 Pcs



1-473

150 mm	2	5	1-473-06-2-2

1-230-06-2-2	
1-210-06-2-2	
1-100-06-2-2	

ERGO™ Engineering File Set Second Cut 200 mm - 3 Pcs



1-473-08-2-2

200 mm	2	5	1-473-08-2-2

1-230-08-2-2	
1-210-08-2-2	
1-100-08-2-2	

ERGO™ Engineering File Set Second Cut 250 mm - 3 Pcs



1-473-10-2-2 1

250 mm	2	5	1-473-10-2-2

1-230-10-2-2	
1-210-10-2-2	
1-100-10-2-2	

ERGO™ Engineering File Set with Half-Round Rasp Second Cut 200 mm - 5 Pcs



1-477

200 mm	2	5	1-477-08-2-2

1-100-08-2-2	
1-210-08-2-2	
6-343-08-2-2	
1-230-08-2-2	
1-170-08-2-2	

ERGO™ Engineering File Set with Half-Round Rasp Second Cut 250 mm - 5 Pcs



1-477-10-2-2

250 mm	2	5	1-477-10-2-2

1-100-10-2-2	
1-210-10-2-2	
6-343-10-2-2	
1-230-10-2-2	
1-170-10-2-2	



ERGO™ Engineering File Set 4 Bastard/1 Second Cut 200 mm - 5 Pcs



1-478

200 mm	1&2	5	1-478-08-1-2

1-210-08-1-2				
1-230-08-1-2				
1-100-08-1-2, 1-100-08-2-2				
1-160-08-1-2				

ERGO™ Engineering File Set 4 Bastard/1 Second Cut 250 mm - 5 Pcs



1-478-10-1-2 1

250 mm	1&2	5	1-478-10-1-2

1-210-10-1-2				
1-230-10-1-2				
1-100-10-1-2, 1-100-10-2-2				
1-160-10-1-2				

ERGO™ Engineering File Set with Cabinet Rasp Bastard Cut 200 mm - 5 Pcs



1-479

200 mm	1	5	1-479-08-1-2

4-138-08-1-2				
1-210-08-1-2				
6-343-08-2-2				
1-230-08-1-2				
1-100-08-1-2				

ERGO™ Engineering File Set with Cabinet Rasp Second Cut 200 mm - 5 Pcs



1-479-08-2-2

200 mm	2	5	1-479-08-2-2

4-138-08-1-2				
1-210-08-2-2				
6-343-08-2-2				
1-230-08-2-2				
1-100-08-2-2				

SHARPENING FILES

ERGO™ Flat Chainsaw Files



166-2

150 mm	3	5	166-6-16-2.5-2

Flat Chainsaw Files Unhandled



166/167-12

150 mm	3	12	166-6-16-2.5-12
200 mm	1	12	167-8-21-3.2-12

Round Chainsaw Files - 12 x 1 Pck



168-1P

150 mm	3.2 mm	12	168-6-3.2-1P
150 mm	3.5 mm	12	168-6-3.5-1P
200 mm	4.0 mm	12	168-8-4.0-1P
200 mm	4.5 mm	12	168-8-4.5-1P
200 mm	4.8 mm	12	168-8-4.8-1P
200 mm	5.2 mm	12	168-8-5.2-1P
200 mm	5.5 mm	12	168-8-5.5-1P
200 mm	6.3 mm	12	168-8-6.3-1P

Round Chainsaw Files - 12 x 3 Pck



168-3P

150 mm	3.2 mm	12	168-6-3.2-3P
150 mm	3.5 mm	12	168-6-3.5-3P
200 mm	4.0 mm	12	168-8-4.0-3P
200 mm	4.5 mm	12	168-8-4.5-3P
200 mm	4.8 mm	12	168-8-4.8-3P
200 mm	5.2 mm	12	168-8-5.2-3P
200 mm	5.5 mm	12	168-8-5.5-3P
200 mm	6.3 mm	12	168-8-6.3-3P

Round Chainsaw Files - 6 Pck



168-8



200 mm	4.0 mm	6	168-8-4.0-6
200 mm	4.5 mm	6	168-8-4.5-6
200 mm	4.8 mm	6	168-8-4.8-6
200 mm	5.2 mm	6	168-8-5.2-6
200 mm	5.5 mm	6	168-8-5.5-6

Mill Saw Files with 1 Round Edge Bastard Cut Unhandled



4-138...-0



150 mm	1	10	4-138-06-1-0
200 mm	1	10	4-138-08-1-0
250 mm	1	10	4-138-10-1-0
300 mm	1	5	4-138-12-1-0

ERGO™ Mill Saw Files with Dual-Component Handle and 2 Round Edges Bastard Cut



4-140...-2



200 mm	1	5	4-140-08-1-2
250 mm	1	5	4-140-10-1-2

ERGO™ Chainsaw File Set with Two-Component Handle and Filing Guide



168-C-G

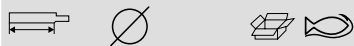

200 mm	4.0 mm	10	168-COMBI-4.0-6922
200 mm	4.8 mm	10	168-COMBI-4.8-6920
200 mm	5.5 mm	10	168-COMBI-5.5-6924

ERGO™ Mill Saw Files with Dual-Component Handle and 1 Round Edge Bastard Cut



4-138...-2



150 mm	1	5	4-138-06-1-2
200 mm	1	5	4-138-08-1-2
250 mm	1	5	4-138-10-1-2
300 mm	1	5	4-138-12-1-2

Mill Saw Files with 2 Flat Edges Bastard Cut Unhandled



4-142



150 mm	1	10	4-142-06-1-0
200 mm	1	10	4-142-08-1-0
250 mm	1	10	4-142-10-1-0

ERGO™ Chainsaw File Set with Two-Component Handle



168-C



200 mm	4.0 mm	10	168-COMBI-4.0
200 mm	4.5 mm	10	168-COMBI-4.5
200 mm	4.8 mm	10	168-COMBI-4.8
200 mm	5.5 mm	10	168-COMBI-5.5

Mill Saw Files with 2 Round Edges Bastard Cut Unhandled



4-140...-0



150 mm	1	10	4-140-06-1-0
200 mm	1	10	4-140-08-1-0
250 mm	1	10	4-140-10-1-0

Mill Saw Files with 1 Round Edge Extra thin Second Cut Unhandled



4-144...-0



200 mm	2	10	4-144-08-2-0
--------	---	----	--------------



ERGO™ Mill Saw Files with Dual-Component Handle and 1 Round Edge Second Cut



ergo



4-144...-2

200 mm	2	5	4-144-08-2-2

4-in-2 ERGO™ Homeowner's File Set with Two-Component Handle for Wood and Metal



ergo



4-154

200 mm	1 & 2	10	4-154-08-2-2

ERGO™ Taper Saw Files with Dual-Component Handle Second Cut



ergo



4-183...-2

100 mm	2	5	4-183-04-2-2
125 mm	2	5	4-183-05-2-2
150 mm	2	5	4-183-06-2-2
175 mm	2	5	4-183-07-2-2
200 mm	2	5	4-183-08-2-2

2-in-1 ERGO™ Homeowner's Files with Two-Component Handle for Wood & Metal



ergo



4-152

200 mm	2 & 2	5	4-152-08-2-2

2-in-1 Farmer's own double Duty Files Bastard Cut



4-155

200 mm	1	10	4-155-08-2-0
250 mm	1	5	4-155-10-2-0

Slim Taper Saw Files Second Cut Unhandled



4-186...-0

100 mm	2	10	4-186-04-2-0
112 mm	2	10	4-186-45-2-0*
125 mm	2	10	4-186-05-2-0
150 mm	2	10	4-186-06-2-0
175 mm	2	10	4-186-07-2-0
200 mm	2	10	4-186-08-2-0

2-in-1 ERGO™ Homeowner's Files with Two-Component Handle for Metal



ergo



4-153

200 mm	1 & 1	5	4-153-08-1-2

Taper Saw Files Second Cut Unhandled



4-183...-0

100 mm	2	10	4-183-04-2-0
125 mm	2	10	4-183-05-2-0
150 mm	2	10	4-183-06-2-0
175 mm	2	10	4-183-07-2-0
200 mm	2	10	4-183-08-2-0
250 mm	2	10	4-183-10-2-0

ERGO™ Slim Taper Files with Dual-Component Handle Second Cut



ergo



4-186...-2

100 mm	2	5	4-186-04-2-2
125 mm	2	5	4-186-05-2-2
150 mm	2	5	4-186-06-2-2

Extra Slim Taper Saw Files Second Cut Unhandled



4-187...-0

Length	Quantity	Material	Product Code
100 mm	2	10	4-187-04-2-0
112 mm	2	10	4-187-45-2-0*
125 mm	2	10	4-187-05-2-0
150 mm	2	10	4-187-06-2-0
175 mm	2	10	4-187-07-2-0

ERGO™ Double Extra Slim Taper Files with Dual-Component Handle Second Cut



4-188...-2

Length	Quantity	Material	Product Code
125 mm	2	5	4-188-05-2-2

Tapered Bandsaw Files Second Cut Unhandled



4-192...-0

Length	Quantity	Material	Product Code
150 mm	2	10	4-192-06-2-0
175 mm	2	10	4-192-07-2-0
200 mm	2	10	4-192-08-2-0

ERGO™ Extra Slim Taper Files with Dual-Component Handle Second Cut



4-187...-2

Length	Quantity	Material	Product Code
125 mm	2	5	4-187-05-2-2
150 mm	2	5	4-187-06-2-2

Double-Ended Saw Files with Wooden Handle Second Cut



4-190...-0

Length	Quantity	Material	Product Code
175 mm	2	10	4-190-07-2-0
200 mm	2	10	4-190-08-2-0

ERGO™ Tapered Bandsaw Files with Dual-Component Handle Second Cut



4-192...-2

Length	Quantity	Material	Product Code
150 mm	2	5	4-192-06-2-2
200 mm	2	5	4-192-08-2-2

Double Extra Slim Taper Saw Files Second Cut Unhandled



4-188...-0

Length	Quantity	Material	Product Code
125 mm	2	10	4-188-05-2-0
150 mm	2	10	4-188-06-2-0

ERGO™ Double-Ended Saw Files with Dual-Component Handle Second Cut



4-190...-2

Length	Quantity	Material	Product Code
150 mm	2	5	4-190-06-2-2
175 mm	2	5	4-190-07-2-2
200 mm	2	5	4-190-08-2-2

Machine Bandsaw Files Second Cut



4-202 - 4-204

Length	Quantity	Material	Product Code
216 mm	2	10	4-202-85-2-0
216 mm	2	10	4-204-85-2-0

* Until stocks last



Wasa™ Double Edge Saw Files Smooth Cut Unhandled



4-272...-0

150 mm	3	10	4-272-06-3-0

ERGO™ Wasa™ Double Edge Saw Files with Dual-Component Handle Smooth Cut



4-272...-2

125 mm	3	5	4-272-05-3-2
150 mm	3	5	4-272-06-3-2

ERGO™ Flat Hand Rasps Medium Cut



6-344...-2

200 mm	2	5	6-344-08-2-2
250 mm	2	5	6-344-10-2-2

Half-Round Rasps Coarse/Medium Cut Unhandled



6-342...-0

150 mm	2	10	6-342-06-2-0
200 mm	1	10	6-342-08-1-0
200 mm	2	10	6-342-08-2-0
250 mm	1	10	6-342-10-1-0
250 mm	2	10	6-342-10-2-0

Half-Round Cabinet Rasps Medium/Fine Cut Unhandled



6-343...-0

200 mm	2	10	6-343-08-2-0
200 mm	3	10	6-343-08-3-0
250 mm	2	10	6-343-10-2-0
250 mm	3	10	6-343-10-3-0

ERGO™ Half-Round Cabinet Rasps Medium Cut



6-343...-2

200 mm	2	5	6-343-08-2-2
250 mm	2	5	6-343-10-2-2

RASPS

Flat Hand Rasps Medium Cut Unhandled



6-344...-0

200 mm	2	10	6-344-08-2-0
250 mm	2	10	6-344-10-2-0

ERGO™ Half-Round Rasps Coarse/Medium Cut



6-342...-2

150 mm	2	5	6-342-06-2-2
200 mm	1	5	6-342-08-1-2
200 mm	2	5	6-342-08-2-2
250 mm	1	5	6-342-10-1-2
250 mm	2	5	6-342-10-2-2

Round Rasps Medium Cut Unhandled



6-345...-0

200 mm	2	10	6-345-08-2-0
250 mm	2	10	6-345-10-2-0

ERGO™ Round Rasps Coarse/Medium Cut



6-345...-2



200 mm	1	5	6-345-08-1-2
200 mm	2	5	6-345-08-2-2
250 mm	1	5	6-345-10-1-2

ERGO™ Rasp File Set Second Cut - 3 Pcs



6-470



200 mm	2	5	6-470-08-2-2
--------	---	---	--------------

6-345-08-2-2



6-342-08-2-2



4-152-08-2-2



MILLED TOOTH FILES

Pansar® Milled Tooth Flat Blades Bastard/Second Cut Unhandled



3-330



300 mm	1	5	3-330-12-1-0
300 mm	2	5	3-330-12-2-0
350 mm	1	5	3-330-14-1-0
350 mm	2	5	3-330-14-2-0

Pansar® Milled Tooth Half-Round Blades Bastard Cut Unhandled



3-331



350 mm	1	5	3-331-14-1-0
--------	---	---	--------------

ERGO™ Milled Tooth Filemasters with Two-component handle



FM10

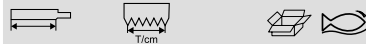

300 mm	4 & 5	5	FM12
250 mm	4 & 5	5	FM10

ERGO™ Milled Tooth Half-Round Filemasters with Two-component handle



HRFM10

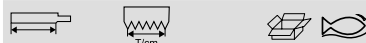

250 mm	5	5	HRFM10
--------	---	---	--------

NEEDLE FILES

Needle Flat Files Bastard/Second/Smooth/Dead Smooth Cut Unhandled



2-300



140 mm	0	10	2-300-14-0-0
140 mm	2	10	2-300-14-2-0
140 mm	4	10	2-300-14-4-0
160 mm	0	10	2-300-16-0-0
160 mm	1	10	2-300-16-1-0
160 mm	2	10	2-300-16-2-0
160 mm	4	10	2-300-16-4-0
180 mm	0	10	2-300-18-0-0
180 mm	2	10	2-300-18-2-0

Needle Flat Files with Tapered Edge Bastard/Second/Smooth Cut Unhandled



2-301



140 mm	0	10	2-301-14-0-0
140 mm	2	10	2-301-14-2-0
160 mm	0	10	2-301-16-0-0
160 mm	1	10	2-301-16-1-0
160 mm	2	10	2-301-16-2-0

Needle Half-Round Files Bastard/Second/Smooth/Dead Smooth Cut Unhandled



2-304



140 mm	0	10	2-304-14-0-0
140 mm	2	10	2-304-14-2-0
140 mm	4	10	2-304-14-4-0
160 mm	0	10	2-304-16-0-0
160 mm	1	10	2-304-16-1-0
160 mm	2	10	2-304-16-2-0
160 mm	4	10	2-304-16-4-0
180 mm	0	10	2-304-18-0-0
180 mm	2	10	2-304-18-2-0



Needle Half-Round Files Bastard Cut Unhandled



2-313

160 mm	0	10	2-313-16-0-0

Needle Crossing Files Second/Smooth Cut Unhandled



2-306

160 mm	1	10	2-306-16-1-0
160 mm	2	10	2-306-16-2-0

Needle Knife Files Bastard/Second/Smooth Cut Unhandled



2-308

140 mm	2	10	2-308-14-2-0
160 mm	0	10	2-308-16-0-0
160 mm	1	10	2-308-16-1-0
160 mm	2	10	2-308-16-2-0

Needle Round Files Bastard/Second/Smooth/Dead Smooth Cut Unhandled



2-307

140 mm	0	10	2-307-14-0-0
140 mm	2	10	2-307-14-2-0
140 mm	4	10	2-307-14-4-0
160 mm	0	10	2-307-16-0-0
160 mm	1	10	2-307-16-1-0
160 mm	2	10	2-307-16-2-0
160 mm	4	10	2-307-16-4-0
180 mm	0	10	2-307-18-0-0
180 mm	2	10	2-307-18-2-0

Needle Three Square Files Bastard/Second/Smooth/Dead Smooth Cut Unhandled



2-302

140 mm	0	10	2-302-14-0-0
140 mm	2	10	2-302-14-2-0
140 mm	4	10	2-302-14-4-0
160 mm	0	10	2-302-16-0-0
160 mm	1	10	2-302-16-1-0
160 mm	2	10	2-302-16-2-0
160 mm	4	10	2-302-16-4-0
180 mm	0	10	2-302-18-0-0
180 mm	2	10	2-302-18-2-0

Needle Square Files Bastard/Second/Smooth/Dead Smooth Cut Unhandled



2-303

140 mm	2	10	2-303-14-2-0
160 mm	0	10	2-303-16-0-0
160 mm	1	10	2-303-16-1-0
160 mm	2	10	2-303-16-2-0
160 mm	4	10	2-303-16-4-0
180 mm	0	10	2-303-18-0-0
180 mm	2	10	2-303-18-2-0

Needle Oval Files Second/Smooth Cut Unhandled



2-305

160 mm	1	10	2-305-16-1-0
160 mm	2	10	2-305-16-2-0

Needle Barrette Files Smooth/Dead Smooth Cut Unhandled



2-309

160 mm	2	10	2-309-16-2-0
160 mm	4	10	2-309-16-4-0

Needle File Set Bastard Cut Unhandled
140 mm - 6 Pcs



2-470

140 mm	0	10	2-470-14-0-0

9-488-02-10	
2-304-14-0-0	
2-300-14-0-0	
2-303-14-0-0	
2-302-14-0-0	
2-301-14-0-0	
2-307-14-0-0	

Needle File Set Smooth Cut Unhandled
140 mm - 6 Pcs



2-470-14-2-0



9-488-02-10	
2-304-14-2-0	
2-300-14-2-0	
2-303-14-2-0	
2-302-14-2-0	
2-301-14-2-0	
2-307-14-2-0	

Needle File Set Dead Smooth Cut
Unhandled 140 mm - 6 Pcs



2-470-14-4-0

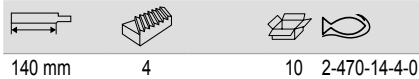

9-488-02-10	
2-304-14-4-0	
2-300-14-4-0	
2-303-14-4-0, 2-301-14-4-0	
2-302-14-4-0	
2-307-14-4-0	

Needle File Set Second Cut Unhandled
160 mm - 6 Pcs



2-470-16-1-0



9-488-02-10	
2-304-16-1-0	
2-300-16-1-0	
2-303-16-1-0	
2-302-16-1-0	
2-301-16-1-0	
2-307-16-1-0	

Needle File Set Smooth Cut Unhandled
160 mm - 6 Pcs



2-470-16-2-0

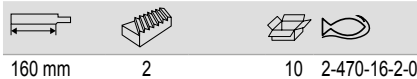

9-488-02-10	
2-304-16-2-0	
2-300-16-2-0	
2-303-16-2-0	
2-302-16-2-0	
2-301-16-2-0	
2-307-16-2-0	

Needle File Set Second Cut Unhandled
160 mm - 9 Pcs



2-471



9-488-02-10	
2-303-16-1-0	
2-304-16-1-0	
2-302-16-1-0	
2-300-16-1-0	
2-308-16-1-0	
2-301-16-1-0	
2-306-16-1-0	
2-305-16-1-0	
2-307-16-1-0	

Needle File Set Bastard Cut Unhandled
140 mm - 12 Pcs



2-472



2-303-14-0-0, 2-313-14-0-0, 2-309-14-0-0, 2-306-14-0-0	
2-300-14-0-0	
2-301-14-0-0	
2-304-14-0-0	
2-302-14-0-0	
2-307-14-0-0	
9-488-02-10	



Needle File Set Smooth Cut Unhandled
140 mm - 12 Pcs



2-472-14-2-0

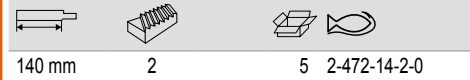

140 mm 2 5 2-472-14-2-0

2-303-14-2-0	
2-300-14-2-0	
2-301-14-2-0	
2-304-14-2-0	
2-302-14-2-0	
2-313-14-2-0, 2-306-14-2-0	
2-307-14-2-0	
2-308-14-2-0	
9-488-02-10	

Needle File Set Bastard Cut Unhandled
160 mm - 12 Pcs



2-472-16-0-0



160 mm 0 5 2-472-16-0-0

2-303-16-0-0	
2-300-16-0-0	
2-301-16-0-0	
2-304-16-0-0	
2-302-16-0-0	
2-313-16-0-0	
2-307-16-0-0	
2-306-16-0-0	
2-308-16-0-0	
9-488-02-10	

Needle File Set Second Cut Unhandled
160 mm - 12 Pcs



2-472-16-1-0

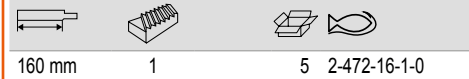

160 mm 1 5 2-472-16-1-0

2-312-16-1-0, 2-313-16-1-0, 2-309-16-1-0

2-300-16-1-0	
2-301-16-1-0	
2-302-16-1-0	
2-303-16-1-0	
2-304-16-1-0	
2-306-16-1-0	
2-307-16-1-0	
2-308-16-1-0	
2-309-16-2-0	
2-311-16-2-0	
2-313-16-2-0	
9-488-02-10	

Needle File Set Smooth Cut Unhandled
160 mm - 12 Pcs



2-472-16-2-0



160 mm 2 5 2-472-16-2-0

2-312-16-2-0

2-303-16-2-0	
2-300-16-2-0	
2-301-16-2-0	
2-311-16-2-0	
2-304-16-2-0	
2-302-16-2-0	
2-313-16-2-0	
2-307-16-2-0	
2-309-16-2-0	
2-306-16-2-0	
2-308-16-2-0	
9-488-02-10	

DIAMOND FILES

Diamond Precision Needle Files
Unhandled



2-300-D - 2-304-D

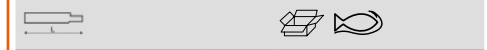

140 mm	10	2-300-14-D-1P
160 mm	10	2-300-16-D-1P
140 mm	1	2-301-14-D-1P
140 mm	10	2-302-14-D-1P
160 mm	10	2-302-16-D-1P
140 mm	10	2-303-14-D-1P
160 mm	1	2-303-16-D-1P
140 mm	10	2-304-14-D-1P
160 mm	10	2-304-16-D-1P

Diamond Precision Needle Files
Unhandled 140/160 mm

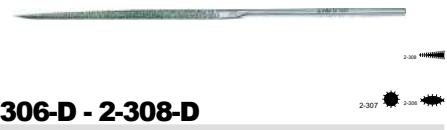

2-306-D - 2-308-D

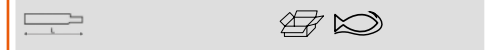

140 mm	1	2-306-14-D-1P
140 mm	10	2-307-14-D-1P
160 mm	10	2-307-16-D-1P
140 mm	1	2-308-14-D-1P

Diamond Precision Files Integrated handle



5-600-D - 5-670-D



215 mm	10	5-600-21-D-1P
215 mm	5	5-610-21-D-1P
215 mm	1	5-630-21-D-1P
215 mm	1	5-670-21-D-1P*

ACCESSORIES

Aluminum Holders for Pansar® 3-330 14" Flat Blade



9-462

350 mm	5	9-462-14-0-0*

Universal Handle for Needle Files



9-488-02

5 g	10	9-488-02-10

Plastic Handles for 8" Round Chainsaw Files



PH-6604

55 g	15	PH-6604-1P
50 g	25	PH-6604-25

File Cleaners with Steel Wire Card



9-467

130 mm	260 mm	1	9-467-00-0-0

Steel Wire File Cards with Wooden Handle



9-469

110 mm	240 mm	1	9-469-00-0-0

ERGO™ Round Shaped Handles for Small files - 10 Pcs Loose



ergo



9-484...10

3.2	3.2 mm	10	9-484-3.2-10
5.2	5.2 mm	10	9-484-5.2-10

ERGO™ Round Shaped Handles for Small files - 1 Pck Carded



ergo



9-484...1P

3.2	3.2 mm	10	9-484-3.2-1P
5.2	5.2 mm	10	9-484-5.2-1P

ERGO™ Oval Shaped Handles for Flat & Half-Round Files - 10 Pcs Loose



ergo



9-485...10

4	4 mm	10	9-485-04-10
5	5 mm	10	9-485-05-10
6	6 mm	10	9-485-06-10
9	9 mm	10	9-485-09-10
13	13 mm	10	9-485-13-10

ERGO™ Oval Shaped Handles for Flat & Half-Round Files - 1 Pck Carded



ergo



9-485...1P

4	4 mm	10	9-485-04-1P
5	5 mm	10	9-485-05-1P
6	6 mm	20	9-485-06-1P
9	9 mm	20	9-485-09-1P
13	13 mm	1	9-485-13-1P

* Until stocks last



ERGO™ Handles for Round Chainsaw Files - 10 Pcs Loose



ergo®



9-486-C-10

3.2	3.2 mm	10	9-486-C-10

ERGO™ Round Shaped Handles for Shaped Files - 10 Pcs Loose



ergo®



9-486...10

4	4 mm	10	9-486-04-10
5	5 mm	10	9-486-05-10
7	7 mm	10	9-486-07-10
8	8 mm	10	9-486-08-10

ERGO™ Handles for Round Chainsaw Files - 1 Pck Carded



ergo®



9-486-C-1P

3.2	3.2 mm	10	9-486-C-1P

ERGO™ Round Shaped Handles for Shaped Files - 1 Pck Carded



ergo®



9-486...1P

4	4 mm	20	9-486-04-1P
5	5 mm	20	9-486-05-1P
7	7 mm	20	9-486-07-1P



Wrenches



ADJUSTABLE WRENCHES

ERGO™ Central Nut Adjustable Wrenches with Rubber Handle and Phosphate Finish



ergo



90



158mm/6"	20 mm	5	9070
208mm/8"	27 mm	5	9071
257mm/10"	31 mm	5	9072
308mm/12"	34 mm	5	9073

ERGO™ rubber handle central nut phosphated adjustable wrench, with reversible jaw.



ergo



90P



158mm/6"	21 mm	5	9070 P
208mm/8"	28 mm	5	9071 P
257mm/10"	33 mm	5	9072 P
308mm/12"	35 mm	5	9073 P

ERGO™ Central Nut Adjustable Wrenches with Rubber Handle and Chrome Finish



ergo



90C



158mm/6"	20 mm	5	9070C
208mm/8"	27 mm	5	9071C
257mm/10"	31 mm	5	9072 C
308mm/12"	34 mm	3	9073 C

ERGO™ Rubber Handle Central Nut Adjustable Wrenches, with reversible jaw.



ergo



90PC



158mm/6"	21 mm	5	9070 PC
208mm/8"	28 mm	5	9071 PC
257mm/10"	33 mm	5	9072 PC
308mm/12"	35 mm	3	9073 PC

ERGO™ Central Nut Wide Opening Jaw Adjustable Wrenches with Rubber Handle and Phosphate Finish



ergo



9029-9035



170mm/6"	32 mm	5	9029
218mm/8"	38 mm	5	9031
270mm/10"	46 mm	5	9033
324mm/12"	55 mm	5	9035

ERGO™ Central Nut Wide Opening Jaw Adjustable Wrenches with Rubber Handle and Chrome Finish



ergo



9029C/9031C



170mm/6"	32 mm	5	9029 C
218mm/8"	38 mm	5	9031 C

ERGO™ Central Nut Wide Opening Thin Jaw Adjustable Wrenches with Rubber Handle



ergo



9029-T/9031-T



170mm/6"	32 mm	5	9029-T
218mm/8"	38 mm	5	9031-T

ERGO™ Central Nut Reversible Extra Wide Opening Jaw Adjustable Wrenches with Rubber Handle



ergo



9031P



218mm/8"	39 mm	5	9031P
----------	-------	---	-------

ERGO™ Central Nut Adjustable Wrench Set with Rubber Handle



ergo



ADJUST3-90



900 g	1	ADJUST 3-90
-------	---	-------------

9070, 9071, 9072



ERGO™ Adjustable Wrenches Twin Pack



ADJUST9031/29



550 g 3 ADJUST 9031/29

9029, 9031



L	Hand	Box	Icon
155mm/6"	20 mm	5	8070 C IP
205mm/8"	27 mm	5	8071 C IP
255mm/10"	31 mm	5	8072 C IP
305mm/12"	34 mm	5	8073 C IP
380mm/15"	44 mm	3	8074 C IP
455mm/18"	53 mm	3	8075 C IP

Standard Central Nut Adjustable Wrenches with Phosphate Finish



86/87

L	Hand	Box	Icon
614mm/24"	63 mm	1	86
770mm/30"	85 mm	1	87

Central Nut Adjustable Wrenches with Phosphate Finish



80

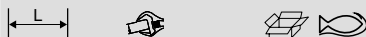

L	Hand	Box	Icon
110mm/4"	13 mm	5	8069
155mm/6"	20 mm	5	8070
205mm/8"	27 mm	5	8071
255mm/10"	31 mm	5	8072
305mm/12"	34 mm	5	8073
380mm/15"	44 mm	3	8074
455mm/18"	53 mm	3	8075
110mm/4"	13 mm	50	8069 IP
155mm/6"	20 mm	40	8070 IP
205mm/8"	27 mm	50	8071 IP
255mm/10"	31 mm	30	8072 IP
305mm/12"	34 mm	20	8073 IP
380mm/15"	44 mm	20	8074 IP
455mm/18"	53 mm	10	8075 IP

Standard Central Nut Adjustable Wrench Set



ADJUST3



810 g 1 ADJUST 3

8070, 8071, 8072



Standard Central Nut Adjustable Wrenches with Chrome Finish



80C

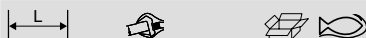

L	Hand	Box	Icon
110mm/4"	13 mm	5	8069 C
155mm/6"	20 mm	5	8070 C
205mm/8"	27 mm	5	8071 C
255mm/10"	31 mm	5	8072 C
305mm/12"	34 mm	5	8073 C
380mm/15"	44 mm	3	8074 C
455mm/18"	53 mm	3	8075 C
110mm/4"	13 mm	5	8069 C IP

Spare Jaw for Central Nut Adjustable Wrenches



RPS

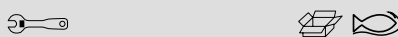

8069, 8069 C	1	8069-1
8070, 8070 C, 9070, 9070 C	1	8070-1
8071, 8071 C, 9071, 9071 C	1	8071-1

Wrench	Box	Icon
8072, 8072 C, 9072, 9072 C	1	8072-1
8073, 8073 C, 9073, 9073 C	1	8073-1
8074, 8074 C	1	8074-1
8075, 8075 C	1	8075-1
9029, 9029 C, 31	1	9029-1
9029-T	1	9029T-1
9031, 9031 C	1	9031-1
9031-T	1	9031T-1
9033, 33H	1	9033-1
9035	1	9035-1
86	1	86-1
87	1	87-1
9031 P	1	9031 P-1
9070 P, 9070 PC	1	9070 P-1
9071 P, 9071 PC	1	9071 P-1
9072 P, 9072 PC	1	9072 P-1
9073 P, 9073 PC	1	9073 P-1

Spare Knurl, Pin & Spring for Central Nut Adjustable Wrenches



RPS2

Wrench	g	Box	Icon
8069, 8069 C	3 g	1	8069-2
8070, 8070 C, 9070, 9070 C, 9070 P, 9070 PC	8 g	1	8070-2
8071, 8071 C, 9071, 9071 C, 9071 P, 9071 PC	10 g	1	8071-2
8072, 8072 C, 9072, 9072 C, 9072 P, 9072 PC	16 g	1	8072-2
8073, 8073 C, 9073, 9073 C, 9073 P, 9073 PC, 9033	25 g	1	8073-2
8074, 8074 C, 9035	47 g	1	8074-2
8075, 8075 C	54 g	1	8075-2
9029, 9029 C, 9029-T, 9031-T, 31, 9031, 9031 C, 9031P	9 g	1	9029-2
86	125 g	1	86-2
87	185 g	1	87-2



Podger Adjustable Wrenches with Phosphate Finish



84

405mm/16"	41 mm	1	84-PODGER

Wide Jaw Adjustable Wrenches with Serrated Pipe Jaws and Phosphate Finish



31

209mm/8"	32 mm	5	31
209mm/8"	32 mm	50	31-IP

Thin Jaw Adjustable Spanners with Serrated Pipe Jaws & Phosphate Finish



31-T

209mm/8"	32 mm	5	31-T
209mm/8"	32 mm	50	31-T-IP

Wide Jaw Adjustable Wrenches with Hook and Phosphate Finish



33H

254mm/10"	46 mm	5	33H

Side Nut Heavy Duty Adjustable Wrenches with Rubber Handle and Phosphate Finish



95

257mm/10"	35 mm	5	9572*

Side Nut Adjustable Wrenches with Chrome Finish



91C/97C

155mm/6"	21 mm	5	91C
205mm/8"	29 mm	5	92C
255mm/10"	34 mm	5	93C
305mm/12"	39 mm	5	94C
405mm/16"	48 mm	1	95C
500mm/20"	60 mm	1	96C
750mm/30"	77 mm	1	97C



COMBINATION WRENCHES

Metric Flat Combination Wrenches with Chrome Finish



111M



5.5 mm	10	111M-5.5
6 mm	10	111M-6
7 mm	10	111M-7
8 mm	10	111M-8
9 mm	10	111M-9
10 mm	10	111M-10
11 mm	10	111M-11
12 mm	10	111M-12
13 mm	10	111M-13
14 mm	10	111M-14
15 mm	10	111M-15
16 mm	10	111M-16
17 mm	10	111M-17
18 mm	10	111M-18
19 mm	10	111M-19
20 mm	10	111M-20
21 mm	10	111M-21
22 mm	5	111M-22
23 mm	5	111M-23
24 mm	5	111M-24
25 mm	5	111M-25
26 mm	5	111M-26
27 mm	5	111M-27
28 mm	5	111M-28
29 mm	5	111M-29
30 mm	5	111M-30
32 mm	5	111M-32
33 mm	5	111M-33
34 mm	5	111M-34
36 mm	1	111M-36
38 mm	1	111M-38
41 mm	1	111M-41
46 mm	1	111M-46
50 mm	1	111M-50
55 mm	1	111M-55
60 mm	1	111M-60
65 mm	1	111M-65
70 mm	1	111M-70
75 mm	1	111M-75
80 mm	1	111M-80
85 mm	1	111M-85
90 mm	1	111M-90
95 mm	1	111M-95
100 mm	1	111M-100
5.5 mm	1	SB111M-5,5
6 mm	1	SB111M-6
7 mm	1	SB111M-7
8 mm	1	SB111M-8
9 mm	1	SB111M-9
10 mm	1	SB111M-10
11 mm	1	SB111M-11
12 mm	1	SB111M-12
13 mm	1	SB111M-13
14 mm	1	SB111M-14
15 mm	1	SB111M-15

		 	
16 mm	1	SB111M-16	
17 mm	1	SB111M-17	
18 mm	1	SB111M-18	
19 mm	1	SB111M-19	
20 mm	1	SB111M-20	
21 mm	1	SB111M-21	
22 mm	1	SB111M-22	
23 mm	1	SB111M-23	
24 mm	1	SB111M-24	
25 mm	1	SB111M-25	
26 mm	1	SB111M-26	
27 mm	1	SB111M-27	
28 mm	1	SB111M-28	
29 mm	1	SB111M-29	
30 mm	1	SB111M-30	
32 mm	1	SB111M-32	

Imperial Stubby Combination Wrenches with Chrome Finish





1Z

		 	
3/16 in	20	1Z-3/16	
7/32 in	20	1Z-7/32*	
9/32 in	20	1Z-9/32	
5/16 in	10	1Z-5/16	
11/32 in	10	1Z-11/32*	
3/8 in	10	1Z-3/8	
7/16 in	10	1Z-7/16	
1/2 in	10	1Z-1/2	
9/16 in	10	1Z-9/16	
5/8 in	10	1Z-5/8	
11/16 in	10	1Z-11/16	
3/4 in	10	1Z-3/4	
13/16 in	10	1Z-13/16	
7/8 in	10	1Z-7/8	
15/16 in	5	1Z-15/16	
1 in	10	1Z-1	

Imperial Flat Combination Wrenches with Chrome Finish





111Z

		 	
1/4 in	5	111Z-1/4	
5/16 in	5	111Z-5/16	
3/8 in	5	111Z-3/8	
7/16 in	5	111Z-7/16	
1/2 in	5	111Z-1/2	
9/16 in	5	111Z-9/16	
5/8 in	5	111Z-5/8	
11/16 in	5	111Z-11/16	
3/4 in	5	111Z-3/4	
13/16 in	5	111Z-13/16	
7/8 in	5	111Z-7/8	
15/16 in	3	111Z-15/16	
1 in	3	111Z-1	
1 1/16 in	5	111Z-1.1/16	
1 1/8 in	5	111Z-1.1/8	
1 1/4 in	5	111Z-1.1/4	
1 5/16 in	5	111Z-1.5/16	
1 3/8 in	1	111Z-1.3/8	
1 7/16 in	1	111Z-1.7/16	
1 1/2 in	1	111Z-1.1/2	
1 5/8 in	1	111Z-1.5/8	
1 11/16 in	1	111Z-1.11/16	
1 3/4 in	1	111Z-1.3/4	
1 13/16 in	1	111Z-1.13/16	
1 7/8 in	1	111Z-1.7/8	
2 in	1	111Z-2	
2 1/8 in	1	111Z-2.1/8	
2 1/4 in	1	111Z-2.1/4	
2 3/8 in	1	111Z-2.3/8	
2 1/2 in	1	111Z-2.1/2	
2 5/8 in	1	111Z-2.5/8	
2 3/4 in	1	111Z-2.3/4	
2 7/8 in	1	111Z-2.7/8	
3 in	1	111Z-3	

Metric Flat Combination Wrenches with Matte Finish



S20

		 	
7	1	SBS20-7*	
8	1	SBS20-8*	
9	1	SBS20-9*	
11	1	SBS20-11*	
12	1	SBS20-12*	
13	1	SBS20-13*	
14	1	SBS20-14*	
15	1	SBS20-15*	
16	1	SBS20-16	
18	1	SBS20-18*	
20	1	SBS20-20*	
21	1	SBS20-21*	
22	1	SBS20-22*	

Metric Flat Combination Wrench Set - 5 Pcs/Plastic Holder



111M/SH5

		 	
5		1	111M/SH5

111M-8, 111M-10, 111M-13, 111M-17, 111M-19

Metric Flat Combination Wrench Set - 8 Pcs/Plastic Holder



111M/SH8

		 	
8		1	111M/SH8

111M-8, 111M-10, 111M-12, 111M-13, 111M-14, 111M-17, 111M-19, 111M-22

Metric Flat Combination Wrench Set 9-18 mm - 12 Pcs/Plastic Holder



111M/SH12

		 	
12		1	111M/SH12

111M-8, 111M-9, 111M-10, 111M-11, 111M-12, 111M-13, 111M-14, 111M-15, 111M-16, 111M-17, 111M-18, 111M-19

* Until stocks last



Metric Flat Combination Wrench Set
Cardboard Box



111M/



10

1 111M/S10

111M-8, 111M-9, 111M-10, 111M-11,
111M-12, 111M-13, 111M-14, 111M-17,
111M-19, 111M-22



Metric Flat Combination Wrench Set - 11
Pcs/Pouch



111M/11T



11

1 111M/11T

111M-8, 111M-9, 111M-10, 111M-11,
111M-12, 111M-13, 111M-14, 111M-15,
111M-17, 111M-19, 111M-22



Metric Flat Combination Wrench Set - 14
Pcs/Pouch



111M/14T



14

1 111M/14T

111M-6, 111M-8, 111M-9, 111M-10,
111M-13, 111M-14, 111M-15, 111M-17,
111M-19, 111M-22, 111M-24, 111M-27,
111M-30, 111M-32



Metric Flat Combination Wrench Set 6-22
mm - 17 Pcs/Pouch



111M/17T



17

1 111M/17T

111M-6, 111M-7, 111M-8, 111M-9,
111M-10, 111M-11, 111M-12, 111M-13,
111M-14, 111M-15, 111M-16, 111M-17,
111M-18, 111M-19, 111M-20, 111M-21,
111M-22



Metric Flat Combination Wrench Set 8-32
mm - 17 Pcs/Pouch



111M/17TL



17

1 111M/17TL

111M-8, 111M-9, 111M-10, 111M-11,
111M-12, 111M-13, 111M-14, 111M-15,
111M-16, 111M-18, 111M-19, 111M-22,
111M-24, 111M-26, 111M-27, 111M-30,
111M-32



Metric Flat Combination Wrench Set - 24
Pcs/Pouch



111M/24T



24

1 111M/24T

111M-6, 111M-7, 111M-8, 111M-9, 111M-10,
111M-11, 111M-12, 111M-13, 111M-14, 111M-15,
111M-16, 111M-17, 111M-18, 111M-19, 111M-20,
111M-21, 111M-22, 111M-24, 111M-26, 111M-27,
111M-28, 111M-30, 111M-32, 111M-36



Metric Flat Combination Wrench Set - 26
Pcs/Pouch



111M/26T



26

1 111M/26T

111M-6, 111M-7, 111M-8, 111M-9,
111M-10, 111M-11, 111M-12, 111M-13,
111M-14, 111M-15, 111M-16, 111M-17,
111M-18, 111M-19, 111M-20, 111M-21,
111M-22, 111M-23, 111M-24, 111M-25,
111M-26, 111M-27, 111M-28, 111M-29,
111M-30, 111M-32



Imperial Flat Combination Wrench Set - 8
Pcs/Black Plastic Pouch



111Z/



8

1 111Z/8T

111Z-3/8, 111Z-7/16, 111Z-1/2, 111Z-9/16, 111Z-5/8, 111Z-11/16, 111Z-3/4, 111Z-7/8



Imperial Flat Combination Wrench Set - 11 Pcs/Black Plastic Pouch



111Z/11T



11 1 111Z/11T

111Z-3/8, 111Z-7/16, 111Z-1/2, 111Z-9/16, 111Z-5/8, 111Z-11/16, 111Z-3/4, 111Z-13/16, 111Z-7/8, 111Z-15/16, 111Z-1



Metric Long Type Combination Wrenches with Chrome Finish



11M



8 mm	5	11M-8
9 mm	5	11M-9
10 mm	5	11M-10
11 mm	5	11M-11
12 mm	5	11M-12
13 mm	5	11M-13
14 mm	5	11M-14
15 mm	5	11M-15
16 mm	5	11M-16
17 mm	5	11M-17
18 mm	5	11M-18
19 mm	5	11M-19
21 mm	5	11M-21
22 mm	5	11M-22
24 mm	5	11M-24
27 mm	1	11M-27
30 mm	1	11M-30
32 mm	1	11M-32
36 mm	1	11M-36
38 mm	1	11M-38

Imperial Long Type Combination Wrenches with Chrome Finish



11Z



3/8 in	5	11Z-3/8*
7/16 in	5	11Z-7/16*
1/2 in	5	11Z-1/2*
9/16 in	5	11Z-9/16*
5/8 in	5	11Z-5/8*
11/16 in	5	11Z-11/16*
3/4 in	5	11Z-3/4*
13/16 in	5	11Z-13/16*
1 in	5	11Z-1*

Metric Lilliput Combination Wrenches with Chrome Finish



4020L-M



3.2 mm	5	4020L-M-3.2
3.5 mm	5	4020L-M-3.5
4 mm	5	4020L-M-4
4.5 mm	5	4020L-M-4.5
5 mm	5	4020L-M-5
5.5 mm	5	4020L-M-5.5

Metric Offset Combination Wrenches with Chrome Finish



1952M



6 mm	10	1952M-6
7 mm	10	1952M-7
8 mm	10	1952M-8
9 mm	10	1952M-9
10 mm	10	1952M-10
11 mm	10	1952M-11
12 mm	10	1952M-12
13 mm	10	1952M-13
14 mm	10	1952M-14
15 mm	10	1952M-15



16 mm	10	1952M-16
17 mm	10	1952M-17
18 mm	10	1952M-18
19 mm	10	1952M-19
20 mm	10	1952M-20
21 mm	10	1952M-21
22 mm	5	1952M-22
23 mm	5	1952M-23
24 mm	5	1952M-24
25 mm	5	1952M-25
26 mm	5	1952M-26
27 mm	5	1952M-27
28 mm	1	1952M-28
29 mm	1	1952M-29
30 mm	1	1952M-30
32 mm	1	1952M-32
34 mm	1	1952M-34
36 mm	1	1952M-36
41 mm	1	1952M-41
46 mm	1	1952M-46
50 mm	1	1952M-50
55 mm	1	1952M-55
60 mm	1	1952M-60
65 mm	1	1952M-65
70 mm	1	1952M-70
75 mm	1	1952M-75
80 mm	1	1952M-80
7 mm	1	SB1952M-7
8 mm	1	SB1952M-8
10 mm	1	SB1952M-10
12 mm	1	SB1952M-12
13 mm	1	SB1952M-13
14 mm	1	SB1952M-14
17 mm	1	SB1952M-17
19 mm	1	SB1952M-19
24 mm	1	SB1952M-24

Imperial Offset Combination Wrenches with Chrome Finish



1952Z



1/4 in	5	1952Z-1/4
5/16 in	5	1952Z-5/16
11/32 in	5	1952Z-11/32
3/8 in	5	1952Z-3/8
7/16 in	5	1952Z-7/16
1/2 in	5	1952Z-1/2
9/16 in	5	1952Z-9/16
5/8 in	5	1952Z-5/8
11/16 in	5	1952Z-11/16
3/4 in	5	1952Z-3/4
13/16 in	5	1952Z-13/16
7/8 in	5	1952Z-7/8
15/16 in	5	1952Z-15/16
1 in	1	1952Z-1
1 1/16 in	1	1952Z-1.1/16
1 1/8 in	1	1952Z-1.1/8
1 1/4 in	1	1952Z-1.1/4
1 5/16 in	1	1952Z-1.5/16
1 3/8 in	1	1952Z-1.3/8
1 7/16 in	1	1952Z-1.7/16
1 1/2 in	1	1952Z-1.1/2
1 5/8 in	1	1952Z-1.5/8

* Until stocks last



Metric Offset Combination Wrenches with 12-Point Dynamic-Drive™



PU

Size	Quantity	Part Number
6 mm	5	PU-6*
7 mm	5	PU-7*
8 mm	5	PU-8
9 mm	5	PU-9*
14 mm	5	PU-14*
20 mm	3	PU-20*
21 mm	3	PU-21*
22 mm	3	PU-22*
23 mm	3	PU-23*
24 mm	3	PU-24*
25 mm	1	PU-25*
26 mm	1	PU-26*
27 mm	1	PU-27*
28 mm	1	PU-28*
29 mm	1	PU-29*
30 mm	1	PU-30*
32 mm	1	PU-32*
36 mm	1	PU-36*

Metric Offset Combination Ratcheting Wrench Set - 12 Pcs



1952M/SH12

		12	1	1952M/SH12
--	--	----	---	------------

1952M-8, 1952M-9, 1952M-10, 1952M-11, 1952M-12, 1952M-13, 1952M-14, 1952M-15, 1952M-16, 1952M-17, 1952M-18, 1952M-19

Metric Offset Combination Wrench Set - 10 Pcs/Box



1952M/

		10	1	1952M/10
--	--	----	---	----------

1952M-8, 1952M-9, 1952M-10, 1952M-11, 1952M-12, 1952M-13, 1952M-14, 1952M-16, 1952M-17, 1952M-19

Metric Offset Combination Ratcheting Wrench Set - 8 Pcs



1952M/SH

		6	1	1952M/SH6
--	--	---	---	-----------

1952M-8, 1952M-10, 1952M-12, 1952M-13, 1952M-14, 1952M-17

Metric Offset Combination Wrench Set - 7 Pcs/Pouch



1952M/T

		7	1	1952M/7T
--	--	---	---	----------

1952M-8, 1952M-10, 1952M-13, 1952M-14, 1952M-17, 1952M-19, 1952M-22

Metric Offset Combination Wrench Set - 14 Pcs/Pouch



1952M/14T

		14	1	1952M/14T
--	--	----	---	-----------

1952M-6, 1952M-8, 1952M-9, 1952M-10, 1952M-13, 1952M-14, 1952M-15, 1952M-17, 1952M-19, 1952M-22, 1952M-24, 1952M-27, 1952M-30, 1952M-32

Metric Offset Combination Wrench Set - 17 Pcs/Pouch



1952M/17T

		17	1	1952M/17T
--	--	----	---	-----------

1952M-6, 1952M-7, 1952M-8, 1952M-9, 1952M-10, 1952M-11, 1952M-12, 1952M-13, 1952M-14, 1952M-15, 1952M-16, 1952M-17, 1952M-18, 1952M-19, 1952M-20, 1952M-21, 1952M-22

Metric Offset Combination Wrench Set - 26 Pcs/Pouch



1952M/26T

		26	1	1952M/26T
--	--	----	---	-----------

1952M-6, 1952M-7, 1952M-8, 1952M-9, 1952M-10, 1952M-11, 1952M-12, 1952M-13, 1952M-14, 1952M-15, 1952M-16, 1952M-17, 1952M-18, 1952M-19, 1952M-20, 1952M-21, 1952M-22, 1952M-23, 1952M-24, 1952M-25, 1952M-26, 1952M-27, 1952M-28, 1952M-29, 1952M-30, 1952M-32

Imperial Offset Combination Wrench Set



1952Z/T



11

1 1952Z/11T

1952Z-1/4, 1952Z-5/16, 1952Z-3/8, 1952Z-7/16, 1952Z-1/2, 1952Z-9/16, 1952Z-5/8, 1952Z-11/16, 1952Z-3/4, 1952Z-13/16, 1952Z-7/8

RATCHETING WRENCHES

Metric Combination Ratcheting Wrenches with Chrome Finish



1RM



6 mm	60	1RM-6
7 mm	60	1RM-7
8 mm	60	1RM-8
9 mm	60	1RM-9
10 mm	60	1RM-10
11 mm	60	1RM-11
12 mm	60	1RM-12
13 mm	60	1RM-13



14 mm	30	1RM-14
15 mm	30	1RM-15
16 mm	30	1RM-16
17 mm	30	1RM-17
18 mm	30	1RM-18
19 mm	30	1RM-19
21 mm	30	1RM-21
22 mm	30	1RM-22
24 mm	30	1RM-24
27 mm	20	1RM-27
30 mm	20	1RM-30
32 mm	20	1RM-32

Imperial Combination Ratcheting Wrenches with Chrome Finish



1RZ



1/4 in	50	1RZ-1/4
5/16 in	60	1RZ-5/16
11/32 in	60	1RZ-11/32
3/8 in	60	1RZ-3/8
7/16 in	60	1RZ-7/16
1/2 in	60	1RZ-1/2
9/16 in	30	1RZ-9/16
5/8 in	30	1RZ-5/8
11/16 in	30	1RZ-11/16
3/4 in	30	1RZ-3/4
7/8 in	30	1RZ-7/8
15/16 in	30	1RZ-15/16

Metric Stubby Combination Ratcheting Wrenches with Chrome Finish



10RM



8 mm	60	10RM-8
10 mm	60	10RM-10
13 mm	60	10RM-13
14 mm	60	10RM-14
17 mm	30	10RM-17
19 mm	30	10RM-19

Imperial Stubby Combination Ratcheting Wrenches with Chrome Finish



10RZ



5/16 in	1	10RZ-5/16
3/8 in	1	10RZ-3/8
7/16 in	1	10RZ-7/16
1/2 in	1	10RZ-1/2
9/16 in	1	10RZ-9/16
5/8 in	1	10RZ-5/8
11/16 in	1	10RZ-11/16
3/4 in	1	10RZ-3/4

Metric Swivel Head Combination Ratcheting Wrenches with Chrome Finish



41RM



8 mm	60	41RM-8
10 mm	60	41RM-10
11 mm	60	41RM-11
12 mm	60	41RM-12
13 mm	60	41RM-13
14 mm	30	41RM-14
17 mm	30	41RM-17
19 mm	30	41RM-19
21 mm	30	41RM-21

Imperial Swivel Head Combination Ratcheting Wrenches with Chrome Finish



41RZ



5/16 in	1	41RZ-5/16
3/8 in	1	41RZ-3/8
7/16 in	1	41RZ-7/16
1/2 in	1	41RZ-1/2
9/16 in	1	41RZ-9/16
5/8 in	30	41RZ-5/8
11/16 in	1	41RZ-11/16
3/4 in	1	41RZ-3/4
13/16 in	30	41RZ-13/16
7/8 in	1	41RZ-7/8



Metric Combination Ratcheting Wrench Set - 6 Pcs/Plastic Holder



1RM/



6

20 1RM/SH6

1RM-8, 1RM-10, 1RM-12, 1RM-13, 1RM-14, 1RM-17



Metric Combination Ratcheting Wrench Set - 5 Pcs/Plastic Box



1RM/S5



5

10 1RM/S5

1RM-8, 1RM-10, 1RM-13, 1RM-17, 1RM-19



Stubby Combination Ratcheting Wrench Set



10RM/



6

1 10RM/SH6

10RM-8, 10RM-10, 10RM-13, 10RM-14, 10RM-17, 10RM-19



Metric Combination Ratcheting Wrench Set - 8 Pcs/Plastic Holder



1RM/SH8



8

1 1RM/SH8

1RM-8, 1RM-10, 1RM-11, 1RM-12, 1RM-13, 1RM-14, 1RM-17, 1RM-19



Imperial Combination Ratcheting Wrench Set Plastic Holder



1RZ/



8

1 1RZ/SH8

1RZ-5/16, 1RZ-3/8, 1RZ-7/16, 1RZ-1/2, 1RZ-9/16, 1RZ-5/8, 1RZ-11/16, 1RZ-3/4



Metric Swivel Head Combination Ratcheting Wrench Set Plastic Holder



41RM/SH8



8

10 41RM/SH8

41RM-8, 41RM-10, 41RM-11, 41RM-12, 41RM-13, 41RM-14, 41RM-17, 41RM-19



Metric Combination Ratcheting Wrench Set - 12 Pcs/Plastic Holder



1RM/SH12



12

10 1RM/SH12

1RM-8, 1RM-9, 1RM-10, 1RM-11, 1RM-12, 1RM-13, 1RM-14, 1RM-15, 1RM-16, 1RM-17, 1RM-18, 1RM-19



Combination Ratcheting Wrench and Adaptors Set



1RMA/S8

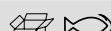

160 x 283 x 75 mm

1 1RMA/S8

1RMA-13-3/8-SQ, 1RMA-10-1/4-SQ, 1RMA-19-1/2-SQ



1RMA-13-5/16-BIT, 1RMA-10-1/4-BIT



1RM-13, 1RM-10, 1RM-19



Ratcheting Adjustable Ring Wrench Set



42RM/S12

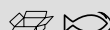

229 x 70 x 280 mm

1562 g

1 42RM/S12

Metric Ratcheting Ring Wrenches with Chrome Finish



1320RM

6-7 mm	60	1320RM-6-7
8-9 mm	60	1320RM-8-9
10-11 mm	60	1320RM-10-11
12-13 mm	60	1320RM-12-13
14-15 mm	30	1320RM-14-15
16-17 mm	30	1320RM-16-17
17-19 mm	30	1320RM-17-19
18-19 mm	30	1320RM-18-19
22-24 mm	30	1320RM-22-24

S Type Ratcheting Ring Wrenches with Chrome Finish



1320SRM

14-19 mm	1	1320SRM-14-19

1320SRM-14-19

1RMA-19-17-HEX, 1RMA-19-16-HEX, 1RMA-19-15-HEX, 1RMA-19-13-HEX, 1RMA-19-9/16-HEX, 1RMA-19-5/8-HEX, 1RMA-19-11/16-HEX, 1RMA-19-1/2-HEX, 1RMA-19-E18-TX, 1RMA-19-E20-TX, 1RMA-19-E16-TX, 1RMA-19-E22-TX, 1RMA-19-1/2-SQ2, 1RMA-14-11-HEX, 1RMA-14-12-HEX, 1RMA-14-E11-TX, 1RMA-14-E12-TX, 1RMA-14-E10-TX, 1RMA-14-E14-TX, 1RMA-14-E8-TX, 1RMA-14-10-HEX, 1RMA-14-7/16-HEX, 1RMA-14-3/8-HEX, 1RMA-14-5/16-HEX, 1RMA-14-8-HEX, 1RMA-14-9-HEX

1RMA-19-1/4-SQ

SBS19-TH22

Imperial Ratcheting Ring Wrenches with Chrome Finish



1320RZ

1/4-5/16" in	60	1320RZ-1/4-5/16
5/16-11/32 in	60	1320RZ-5/16-11/32
3/8-7/16" in	60	1320RZ-3/8-7/16
1/2-9/16" in	30	1320RZ-1/2-9/16
5/8-11/16" in	30	1320RZ-5/8-11/16
3/4-13/16" in	30	1320RZ-3/4-13/16
3/4-7/8" in	30	1320RZ-3/4-7/8
7/8-15/16" in	30	1320RZ-7/8-15/16

Metric Ratcheting Ring Wrench Set



1320RM/

8	1	1320RM/SH8

1320RM-6-7, 1320RM-8-9, 1320RM-10-11, 1320RM-12-13, 1320RM-14-15, 1320RM-16-17, 1320RM-18-19, 1320RM-22-24

4-in-1 Ratcheting Ring Wrenches with Chrome Finish



S4RM

4x5 6x7 mm	60	S4RM-4-7
8x9 10x11 mm	60	S4RM-8-11
12x13 14x15 mm	30	S4RM-12-15
16x17 18x19 mm	50	S4RM-16-19
20x21 24x27 mm	20	S4RM-21-27
30x32 34x36 mm	10	S4RM-30-36

4-in-1 Ratcheting Ring Wrench Set - 3 Pcs/Pouch



S4RM/

3	20	S4RM/3T

S4RM-8-11, S4RM-12-15, S4RM-16-19

Imperial Angled Head Ratcheting Ring Wrenches with Chrome Finish



1321RZ

3/8-7/16 in	1	1321RZ-3/8-7/16
1/2-9/16 in	1	1321RZ-1/2-9/16
5/8-11/16 in	1	1321RZ-5/8-11/16
3/4x7/8 in	1	1321RZ-3/4-7/8

S Type Ratcheting Ring Wrench and Adaptor Set



1320SRM/

29	1	1320SRM/S29*

* Until stocks last



4-in-1 Ratcheting Ring Wrench Set - 4 Pcs/Pouch



S4RM/4T



4 8 S4RM/4T

S4RM-8-11, S4RM-12-15, S4RM-16-19, S4RM-21-27



4-in-1 Ratcheting Ring Wrench Set - 5 Pcs/Pouch



S4RM/5T



5 8 S4RM/5T

S4RM-8-11, S4RM-12-15, S4RM-16-19, S4RM-21-27, S4RM-30-36



Drive Socket and Bit Adaptors for Ratcheting Wrenches



1RMA-SQ



1/4 in	10 mm	1	1RMA-10-1/4-SQ
3/8 in	13 mm	1	1RMA-13-3/8-SQ
1/2 in	19 mm	1	1RMA-19-1/2-SQ
1/4 in	19 mm	100	1RMA-19-1/4-SQ

Ratcheting Wrenches Adaptors for 1/4" and 5/16" Bits



1RMA-BIT



1/4	10 mm	1	1RMA-10-1/4-BIT
5/16	13 mm	1	1RMA-13-5/16-BIT
10	13 mm	1	1RMA-13-10-BIT

Ratcheting Wrench Adaptor Set



1RMA/S4



84 x 100 x 35 mm 30 1RMA/S4

1RMA-10-1/4-SQ, 1RMA-19-1/2-SQ, 1RMA-13-3/8-SQ



1RMA-10-1/4-BIT



OPEN END WRENCHES

Metric Double Open End Wrenches with Chrome Finish



6M



4x5 mm	10	6M-4-5
4.5x5.5 mm	10	6M-4.5-5.5
5x5.5 mm	10	6M-5-5.5



5.5x7 mm	10	6M-5.5-7
6x7 mm	10	6M-6-7
7x8 mm	10	6M-7-8
8x9 mm	10	6M-8-9
8x10 mm	10	6M-8-10
10x11 mm	10	6M-10-11
10x13 mm	10	6M-10-13
12x13 mm	10	6M-12-13
12x14 mm	10	6M-12-14
13x14 mm	10	6M-13-14
13x15 mm	10	6M-13-15
13x16 mm	10	6M-13-16
13x17 mm	10	6M-13-17
14x15 mm	10	6M-14-15
14x17 mm	10	6M-14-17
16x17 mm	10	6M-16-17
16x18 mm	10	6M-16-18
17x19 mm	10	6M-17-19
18x19 mm	10	6M-18-19
19x22 mm	10	6M-19-22
19x24 mm	10	6M-19-24
20x22 mm	10	6M-20-22
21x23 mm	10	6M-21-23
21x24 mm	10	6M-21-24
22x24 mm	10	6M-22-24
24x26 mm	10	6M-24-26
24x27 mm	10	6M-24-27
24x30 mm	5	6M-24-30
25x28 mm	5	6M-25-28
27x29 mm	5	6M-27-29
27x30 mm	5	6M-27-30
27x32 mm	5	6M-27-32
30x32 mm	5	6M-30-32
30x36 mm	5	6M-30-36
32x36 mm	5	6M-32-36
34x36 mm	1	6M-34-36
36x41 mm	1	6M-36-41
38x42 mm	1	6M-38-42
41x46 mm	1	6M-41-46
46x50 mm	1	6M-46-50
4x5 mm	1	SB6M-4-5
6x7 mm	1	SB6M-6-7
8x9 mm	1	SB6M-8-9
10x11 mm	1	SB6M-10-11
12x13 mm	1	SB6M-12-13
14x15 mm	1	SB6M-14-15
16x17 mm	1	SB6M-16-17
17x19 mm	1	SB6M-17-19
18x19 mm	1	SB6M-18-19
20x22 mm	1	SB6M-20-22
21x23 mm	1	SB6M-21-23
22x24 mm	1	SB6M-22-24
24x26 mm	1	SB6M-24-26
24x27 mm	1	SB6M-24-27
25x28 mm	1	SB6M-25-28
27x29 mm	1	SB6M-27-29
30x32 mm	1	SB6M-30-32

Imperial Double Open End Wrenches with Chrome Finish



6Z

Wrench Size	Quantity	Part Number
1/4x5/16 in	5	6Z-1/4-5/16
5/16x11/32 in	5	6Z-5/16-11/32
3/8x7/16 in	5	6Z-3/8-7/16
7/16x1/2 in	5	6Z-7/16-1/2
1/2x9/16 in	5	6Z-1/2-9/16
9/16x5/8 in	5	6Z-9/16-5/8
19/32x11/16 in	5	6Z-19/32-11/16
5/8x3/4 in	5	6Z-5/8-3/4
11/16x3/4 in	5	6Z-11/16-3/4
3/4x7/8 in	5	6Z-3/4-7/8
25/32x13/16 in	5	6Z-25/32-13/16
13/16x7/8 in	5	6Z-13/16-7/8
7/8x15/16 in	5	6Z-7/8-15/16
15/16x1 in	5	6Z-15/16-1
1x1.1/8 in	1	6Z-1-1.1/8
1.1/16x1.1/4 in	1	6Z-1.1/16-1.1/4
1.1/4x1.3/8 in	1	6Z-1.1/4-1.3/8

Imperial Lilliput Double Open End Wrenches with Chrome Finish



1931Z

Wrench Size	Length	Quantity	Part Number
1/8 in	74 mm	5	1931Z-1/8
5/32 in	80 mm	5	1931Z-5/32
3/16 in	80 mm	5	1931Z-3/16
1/32 in	80 mm	5	1931Z-13/64
7/32 in	80 mm	5	1931Z-7/32
15/64x1/4 in	84 mm	5	1931Z-15/64-1/4
1/4 in	80 mm	5	1931Z-1/4
9/32 in	90 mm	5	1931Z-9/32
9/32x5/16 in	94 mm	5	1931Z-9/32-5/16
5/16 in	90 mm	5	1931Z-5/16
11/32 in	105 mm	5	1931Z-11/32
11/32x3/8 in	94 mm	5	1931Z-11/32-3/8
3/8 in	105 mm	5	1931Z-3/8
7/16 in	120 mm	5	1931Z-7/16
1/2 in	120 mm	5	1931Z-1/2
9/16 in	130 mm	5	1931Z-9/16
5/8 in	130 mm	5	1931Z-5/8

Metric Double Open End Wrench Set - 8 Pcs/Plastic Holder



6M/SH

Wrench Size	Quantity	Part Number
8	1	6M/SH8

6M-6-7, 6M-8-9, 6M-10-11, 6M-12-13, 6M-14-15, 6M-16-17, 6M-18-19, 6M-20-22

Metric Double Open End Wrench Set - 12 Pcs/Plastic Holder



6M/SH12

Wrench Size	Quantity	Part Number
12	1	6M/SH12

6M-6-7, 6M-8-9, 6M-10-11, 6M-12-13, 6M-14-15, 6M-16-17, 6M-18-19, 6M-20-22, 6M-21-23, 6M-24-26, 6M-25-28, 6M-30-32

Metric Lilliput Double Open End Wrenches with Chrome Finish



1931M

Wrench Size	Quantity	Part Number
4 mm	5	1931M-4
4.5 mm	5	1931M-4.5
5 mm	5	1931M-5
5.5 mm	5	1931M-5.5
6 mm	5	1931M-6
7 mm	5	1931M-7
8 mm	5	1931M-8
9 mm	5	1931M-9
10 mm	5	1931M-10
11 mm	5	1931M-11
12 mm	5	1931M-12
13 mm	5	1931M-13
14 mm	5	1931M-14
17 mm	5	1931M-17

Metric Double Open End Wrenches with Phosphate Finish



895M

Wrench Size	Length	Quantity	Part Number
6x7 mm	96 mm	10	895M-6-7
8x9 mm	109 mm	10	895M-8-9
8x10 mm	115 mm	10	895M-8-10
10x11 mm	124 mm	10	895M-10-11
10x13 mm	110 mm	10	895M-10-13
13x17 mm	155 mm	10	895M-13-17
17x19 mm	172 mm	10	895M-17-19
19x22 mm	195 mm	10	895M-19-22
19x24 mm	206 mm	5	895M-19-24
22x24 mm	220 mm	5	895M-22-24
24x27 mm	244 mm	5	895M-24-27
24x30 mm	265 mm	5	895M-24-30
27x32 mm	270 mm	5	895M-27-32
30x32 mm	275 mm	5	895M-30-32
30x36 mm	305 mm	1	895M-30-36
32x36 mm	307 mm	1	895M-32-36
36x41 mm	345 mm	1	895M-36-41
41x46 mm	381 mm	1	895M-41-46
46x50 mm	420 mm	1	895M-46-50
50x55 mm	460 mm	1	895M-50-55
55x60 mm	500 mm	1	895M-55-60
65x70 mm	580 mm	1	895M-65-70

Metric Double Open End Wrench Set - 8 Pcs/Box



6M/S

Wrench Size	Quantity	Part Number
8	1	6M/S8

6M-6-7, 6M-8-9, 6M-10-11, 6M-12-13, 6M-14-15, 6M-16-17, 6M-18-19, 6M-20-22



Metric Double Open End Wrench Set - 6 Pcs/Plastic Clip



6M/



6

1 6M/6C

6M-6-7, 6M-8-9, 6M-10-11, 6M-12-13, 6M-14-15, 6M-16-17



Metric Double Open End Wrench Set - 12 Pcs/Plastic Clip



6M/12C



12

1 6M/12C

6M-6-7, 6M-8-9, 6M-10-11, 6M-12-13, 6M-14-15, 6M-16-17, 6M-18-19, 6M-20-22, 6M-21-23, 6M-24-27, 6M-25-28, 6M-30-32



Imperial Lilliput Double Open End Wrench Set



1931Z/



12

1 1931Z/12T

1931Z-5/32, 1931Z-9/32, 1931Z-5/16, 1931Z-11/32, 1931Z-3/8, 1931Z-3/16, 1931Z-7/32, 1931Z-1/4, 1931Z-7/16, 1931Z-1/2, 1931Z-5/8, 1931Z-9/16



Metric Double Open End Wrench Set - 8 Pcs/Plastic Clip



6M/8C



8

1 6M/8C

6M-6-7, 6M-8-9, 6M-10-11, 6M-12-13, 6M-14-15, 6M-16-17, 6M-18-19, 6M-20-22



Imperial Double Open End Wrench Set



6Z/



8

1 6Z/8C

6Z-1/4-5/16, 6Z-3/8-7/16, 6Z-5/16-11/32, 6Z-1/2-9/16, 6Z-19/32-11/16, 6Z-5/8-3/4, 6Z-13/16-7/8, 6Z-15/16-1



Metric Electronic Double Open End Wrench Set



1933M/



6

1 1933M/6T

4x4, 4.5x4.5, 5x5, 5.5x5.5, 6x6, 7x7

Metric Double Open End Wrench Set - 10 Pcs/Plastic Clip



6M/10C



10

1 6M/10C

6M-6-7, 6M-8-9, 6M-10-11, 6M-12-13, 6M-14-15, 6M-16-17, 6M-18-19, 6M-20-22, 6M-24-27, 6M-30-32



Metric Lilliput Double Open End Wrench Set



1931M/



10

1 1931M/10T

1931M-4, 1931M-4.5, 1931M-5, 1931M-5.5, 1931M-6, 1931M-7, 1931M-8, 1931M-9, 1931M-10, 1931M-11



Metric Double Open End Magneto Wrench Set on Ring



3280M/



8

1 3280M

4, 4.5, 5, 5.5, 6, 6.5, 7, 7.5 mm

1/4" Square Drive Crowfoot Open End Wrenches



677-

Icon	Icon	Icon	Icon
7 mm	1/4 in	1	677-7
8 mm	1/4 in	1	677-8
9 mm	1/4 in	1	677-9
10 mm	1/4 in	1	677-10
13 mm	1/4 in	1	677-13
3/8 in	1/4 in	1	677-3/8

3/8" Square Drive Crowfoot Open End Wrenches



747-

Icon	Icon	Icon	Icon
10 mm	3/8 in	1	747-10
11 mm	3/8 in	1	747-11
12 mm	3/8 in	1	747-12
13 mm	3/8 in	1	747-13
14 mm	3/8 in	1	747-14
15 mm	3/8 in	1	747-15
16 mm	3/8 in	1	747-16
17 mm	3/8 in	1	747-17
18 mm	3/8 in	1	747-18
19 mm	3/8 in	1	747-19
20 mm	3/8 in	1	747-20
21 mm	3/8 in	1	747-21
22 mm	3/8 in	1	747-22
23 mm	3/8 in	1	747-23
24 mm	3/8 in	1	747-24
25 mm	3/8 in	1	747-25
26 mm	3/8 in	1	747-26
27 mm	3/8 in	1	747-27
28 mm	3/8 in	1	747-28
30 mm	3/8 in	1	747-30
32 mm	3/8 in	1	747-32
34 mm	3/8 in	1	747-34
36 mm	3/8 in	1	747-36
40 mm	3/8 in	1	747-40
41 mm	3/8 in	1	747-41
42 mm	3/8 in	1	747-42

Icon	Icon	Icon	Icon
46 mm	3/8 in	1	747-46
50 mm	3/8 in	1	747-50
3/8 in	3/8 in	1	747-3/8
7/16 in	3/8 in	1	747-7/16
1/2 in	3/8 in	1	747-1/2
9/16 in	3/8 in	1	747-9/16
5/8 in	3/8 in	1	747-5/8
11/16 in	3/8 in	1	747-11/16
3/4 in	3/8 in	1	747-3/4
13/16 in	3/8 in	1	747-13/16
7/8 in	3/8 in	1	747-7/8
15/16 in	3/8 in	1	747-15/16
1 in	3/8 in	1	747-1
1.1/16 in	3/8 in	1	747-1.1/16
1.1/8 in	3/8 in	1	747-1.1/8
1.3/16 in	3/8 in	1	747-1.3/16
1.1/4 in	3/8 in	1	747-1.1/4
1.5/16 in	3/8 in	1	747-1.5/16
1.3/8 in	3/8 in	1	747-1.3/8
1.7/16 in	3/8 in	1	747-1.7/16
1.1/2 in	3/8 in	1	747-1.1/2
1.9/16 in	3/8 in	1	747-1.9/16
1.5/8 in	3/8 in	1	747-1.5/8
1.11/16 in	3/8 in	1	747-1.11/16
1.3/4 in	3/8 in	1	747-1.3/4
1.13/16 in	3/8 in	1	747-1.13/16
1.7/8 in	3/8 in	1	747-1.7/8
1.15/16 in	3/8 in	1	747-1.15/16
2 in	3/8 in	1	747-2
2.1/16 in	3/8 in	1	747-2.1/16
2.1/8 in	3/8 in	1	747-2.1/8
2.3/16 in	3/8 in	1	747-2.3/16
2.1/4 in	3/8 in	1	747-2.1/4
2.5/16 in	3/8 in	1	747-2.5/16
2.3/8 in	3/8 in	1	747-2.3/8
2.7/16 in	3/8 in	1	747-2.7/16
2.1/2 in	3/8 in	1	747-2.1/2
2.9/16 in	3/8 in	1	747-2.9/16
2.5/8 in	3/8 in	1	747-2.5/8
2.3/4 in	3/8 in	1	747-2.3/4
2.7/8 in	3/8 in	1	747-2.7/8

1/2" Square Drive Crowfoot Open End Wrenches



787-

Icon	Icon	Icon	Icon
1.1/16 in	1/2 in	1	787-1.1/16
1.1/8 in	1/2 in	1	787-1.1/8
1.3/16 in	1/2 in	1	787-1.3/16
1.1/4 in	1/2 in	1	787-1.1/4
1.5/16 in	1/2 in	1	787-1.5/16
1.3/8 in	1/2 in	1	787-1.3/8
1.7/16 in	1/2 in	1	787-1.7/16
1.1/2 in	1/2 in	1	787-1.1/2
1.5/8 in	1/2 in	1	787-1.5/8

Icon	Icon	Icon	Icon
1.11/16 in	1/2 in	1	787-1.11/16
1.3/4 in	1/2 in	1	787-1.3/4
1.13/16 in	1/2 in	1	787-1.13/16
1.7/8 in	1/2 in	1	787-1.7/8
2 in	1/2 in	1	787-2
2.1/8 in	1/2 in	1	787-2.1/8
2.3/16 in	1/2 in	1	787-2.3/16
2.1/4 in	1/2 in	1	787-2.1/4
2.3/8 in	1/2 in	1	787-2.3/8

Metric Single Open End Wrenches with Phosphate Finish



894M

Icon	Icon	Icon	Icon
7 mm	78 mm	10	894M-7
8 mm	94 mm	10	894M-8
9 mm	100 mm	10	894M-9
10 mm	106 mm	10	894M-10
11 mm	112 mm	10	894M-11
12 mm	125 mm	10	894M-12
13 mm	125 mm	10	894M-13
14 mm	140 mm	10	894M-14
15 mm	140 mm	10	894M-15
16 mm	140 mm	10	894M-16
17 mm	158 mm	10	894M-17
19 mm	171 mm	10	894M-19
21 mm	195 mm	5	894M-21
22 mm	195 mm	5	894M-22
24 mm	216 mm	5	894M-24
27 mm	240 mm	5	894M-27
30 mm	262 mm	5	894M-30
32 mm	274 mm	5	894M-32
34 mm	274 mm	1	894M-34
36 mm	303 mm	5	894M-36
38 mm	305 mm	1	894M-38
41 mm	343 mm	1	894M-41
46 mm	378 mm	1	894M-46
50 mm	413 mm	1	894M-50
55 mm	457 mm	1	894M-55
60 mm	492 mm	1	894M-60
65 mm	528 mm	1	894M-65
70 mm	573 mm	1	894M-70
75 mm	608 mm	1	894M-75
80 mm	644 mm	1	894M-80
85 mm	690 mm	1	894M-85
90 mm	690 mm	1	894M-90
95 mm	850 mm	1	894M-95
100 mm	1000 mm	1	894M-100
105 mm	1000 mm	1	894M-105
110 mm	1000 mm	1	894M-110
115 mm	1000 mm	1	894M-115
120 mm	1000 mm	1	894M-120
125 mm	1000 mm	1	894M-125
130 mm	1000 mm	1	894M-130
135 mm	1000 mm	1	894M-135



Metric Scaffolding Open End Wrench with Phosphate finish



Size	Length (L)	Quantity	Part No.
30x32 mm	362 mm	5	2M-30-32
32x36 mm	402 mm	1	2M-32-36
36x41 mm	438 mm	1	2M-36-41
41x46 mm	485 mm	1	2M-41-46
46x50 mm	535 mm	1	2M-46-50

SC335M

Size	Length (L)	Quantity	Part No.
17 mm	320 mm	1	SC335M-17
19 mm	350 mm	1	SC335M-19
22 mm	350 mm	1	SC335M-22
24 mm	370 mm	1	SC335M-24
32 mm	400 mm	1	SC335M-32
36 mm	430 mm	1	SC335M-36
41 mm	470 mm	1	SC335M-41
46 mm	500 mm	1	SC335M-46

RING END WRENCHES

Metric Deep Offset Double Ring End Wrenches with Chrome Finish



2M

Size	Length (L)	Quantity	Part No.
6x7 mm	165 mm	5	2M-6-7
8x9 mm	180 mm	5	2M-8-9
8x10 mm	180 mm	5	2M-8-10
10x11 mm	190 mm	5	2M-10-11
10x13 mm	190 mm	5	2M-10-13
12x13 mm	210 mm	5	2M-12-13
13x17 mm	243 mm	5	2M-13-17
14x15 mm	226 mm	5	2M-14-15
16x17 mm	246 mm	5	2M-16-17
16x18 mm	246 mm	5	2M-16-18
17x19 mm	266 mm	5	2M-17-19
18x19 mm	266 mm	5	2M-18-19
19x22 mm	291 mm	5	2M-19-22
20x22 mm	291 mm	5	2M-20-22
21x23 mm	306 mm	5	2M-21-23
22x24 mm	306 mm	5	2M-22-24
24x26 mm	326 mm	5	2M-24-26
24x27 mm	326 mm	5	2M-24-27
25x28 mm	336 mm	5	2M-25-28
27x29 mm	351 mm	5	2M-27-29
27x30 mm	351 mm	5	2M-27-30
27x32 mm	353 mm	5	2M-27-32

Imperial Deep Offset Double Ring End Wrenches with Chrome Finish



2Z

Size	Length (L)	Quantity	Part No.
1/4x5/16 in	165 mm	1	2Z-1/4-5/16
5/16x3/8 in	180 mm	1	2Z-5/16-3/8
3/8x7/16 in	190 mm	1	2Z-3/8-7/16
1/2x9/16 in	210 mm	1	2Z-1/2-9/16
9/16x5/8 in	225.8 mm	1	2Z-9/16-5/8
5/8x11/16 in	245.5 mm	1	2Z-5/8-11/16
3/4x7/8 in	290.5 mm	1	2Z-3/4-7/8
13/16x7/8 in	290.5 mm	1	2Z-13/16-7/8
15/16x1 in	325.8 mm	1	2Z-15/16-1
1x1 1/8 in	335.9 mm	1	2Z-1-1.1/8
1 1/16x1 1/4 in	353 mm	1	2Z-1.1/16-1.1/4

Imperial Offset Double Ring End Wrenches with Chrome Finish



1300Z

Size	Length (L)	Quantity	Part No.
1/4x5/16 in	156 mm	1	1300Z-1/4-5/16*
3/8x7/16 in	193 mm	1	1300Z-3/8-7/16*
1/2x9/16 in	220 mm	1	1300Z-1/2-9/16*
19/32x11/16 in	258 mm	1	1300Z-19/32-11/16*
5/8x3/4 in	278 mm	1	1300Z-5/8-3/4*
25/32x13/16 in	300 mm	1	1300Z-25/32-13/16*
7/8x15/16 in	334 mm	1	1300Z-7/8-15/16*
15/16x1 in	352 mm	1	1300Z-15/16-1*
1x1.1/8 in	380 mm	1	1300Z-1-1.1/8*

Metric Deep Offset Double Ring End Wrench Set - 8 Pcs/Box



2M/S

Quantity	Part No.
8	1 2M/S8

2M-6-7, 2M-8-9, 2M-10-11, 2M-12-13, 2M-14-15, 2M-16-17, 2M-18-19, 2M-20-22

Metric Deep Offset Double Ring End Wrench Set - 8 Pcs/Pouch



2M/T

Quantity	Part No.
8	1 2M/T8

2M-6-7, 2M-8-9, 2M-10-11, 2M-12-13, 2M-14-15, 2M-16-17, 2M-18-19, 2M-20-22

Metric Deep Offset Double Ring End Wrench Set - 10 Pcs/Pouch



2M/10T

Quantity	Part No.
10	1 2M/10T

2M-6-7, 2M-8-9, 2M-10-11, 2M-12-13, 2M-14-15, 2M-16-17, 2M-18-19, 2M-20-22, 2M-21-23, 2M-24-27

Metric Deep Offset Double Ring End Wrench Set - 12 Pcs/Pouch



2M/12T

Wrench Size	Quantity	Part Number
12	1	2M/12T

2M-6-7, 2M-8-9, 2M-10-11, 2M-12-13, 2M-14-15, 2M-16-17, 2M-18-19, 2M-20-22, 2M-21-23, 2M-24-27, 2M-25-28, 2M-30-32

Imperial Deep Offset Double Ring End Wrench Set Black Plastic Pouch



2Z/T

Wrench Size	Quantity	Part Number
7	1	2Z/T

2Z-1/4-5/16, 2Z-5/16-3/8, 2Z-3/8-7/16, 2Z-1/2-9/16, 2Z-9/16-5/8, 2Z-5/8-11/16, 2Z-3/4-7/8

Flat Double Ring End Wrenches with Chrome Finish



4M

Wrench Size	Length	Quantity	Part Number
6x7 mm	95 mm	10	4M-6-7
8x 9 mm	110 mm	10	4M-8-9
10x11 mm	125 mm	10	4M-10-11
12x13 mm	140 mm	10	4M-12-13

Wrench Size	Length	Quantity	Part Number
14x15 mm	155 mm	10	4M-14-15
16x17 mm	170 mm	10	4M-16-17
17x19 mm	170 mm	10	4M-17-19
18x19 mm	185 mm	10	4M-18-19
20x22 mm	205 mm	10	4M-20-22
21x23 mm	225 mm	5	4M-21-23
24x26 mm	250 mm	1	4M-24-26
24x27 mm	255 mm	1	4M-24-27
25x28 mm	275 mm	1	4M-25-28
27x29 mm	275 mm	1	4M-27-29
30x32 mm	300 mm	1	4M-30-32

Imperial Long Type Double Ring End Wrenches



44Z

Wrench Size	Length	Quantity	Part Number
1/4x5/16 in	197 mm	10	44Z-1/4-5/16
5/16x3/8 in	238 mm	10	44Z-5/16-3/8
3/8x7/16 in	284 mm	10	44Z-3/8-7/16
7/16x1/2 in	326 mm	10	44Z-7/16-1/2
1/2x9/16 in	358 mm	10	44Z-1/2-9/16
5/8x3/4 in	401 mm	5	44Z-5/8-3/4
11/16x3/4 in	401 mm	5	44Z-11/16-3/4
11/16x13/16 in	410 mm	5	44Z-11/16-13/16

Metric Starter and Manifold Flat Half Moon Box Wrenches with Double Ring End



1943M

Wrench Size	Length	Quantity	Part Number
11x13 mm	150 mm	1	1943M-11-13*
13x15 mm	185 mm	1	1943M-13-15*
13x17 mm	185 mm	1	1943M-13-17*
14x17 mm	185 mm	1	1943M-14-17*
15x17 mm	185 mm	1	1943M-15-17*
19x22 mm	235 mm	1	1943M-19-22*

Imperial Starter and Manifold Flat Half Moon Box Wrenches with Double Ring End



1943Z

Wrench Size	Length	Quantity	Part Number
5/16x3/8 in	153 mm	1	1943Z-5/16-3/8*
7/16x1/2 in	153 mm	1	1943Z-7/16-1/2*
9/16x5/8 in	186 mm	1	1943Z-9/16-5/8*
5/8x3/4 in	233 mm	1	1943Z-5/8-3/4*
11/16x13/16 in	233 mm	1	1943Z-11/16-13/16*

Metric Flat Double Ring End Wrench Set Black Plastic Pouch



4M/T

Wrench Size	Quantity	Part Number
10	1	4M/10T

4M-6-7, 4M-8-9, 4M-10-11, 4M-12-13, 4M-14-15, 4M-16-17, 4M-18-19, 4M-20-22, 4M-24-27, 4M-30-32

Metric Flat Double Ring End Wrench Set Grey Plastic Clip Pack



4M/C

Wrench Size	Quantity	Part Number
10	1	4M/10C

4M-6-7, 4M-8-9, 4M-10-11, 4M-12-13, 4M-14-15, 4M-16-17, 4M-18-19, 4M-20-22, 4M-21-23, 4M-24-27

* Until stocks last



Metric Flat Double Ring End Wrench Set



4M/12C

12	1	4M/12C

4M-6-7, 4M-8-9, 4M-10-11, 4M-12-13, 4M-14-15, 4M-16-17, 4M-18-19, 4M-20-22, 4M-21-23, 4M-24-27, 4M-25-28, 4M-30-32

Metric Flat Double Ring End Wrench Set Standard Cardboard Box



4M/

8	1	4M/8

4M-6-7, 4M-8-9, 4M-10-11, 4M-12-13, 4M-14-15, 4M-16-17, 4M-18-19, 4M-20-22

FLARE NUT WRENCHES

Metric Double End Offset Flare Nut Wrenches with Chrome Finish



1949M

8x 9 mm	140 mm	1	1949M-8-9
10x11 mm	150 mm	1	1949M-10-11
10x12 mm	150 mm	1	1949M-10-12

12x13 mm	170 mm	1	1949M-12-13
12x14 mm	170 mm	1	1949M-12-14
14x15 mm	170 mm	1	1949M-14-15
14x17 mm	200 mm	1	1949M-14-17
17x19 mm	210 mm	1	1949M-17-19
19x22 mm	220 mm	1	1949M-19-22
22x24 mm	235 mm	1	1949M-22-24
24x27 mm	255 mm	1	1949M-24-27
30x32 mm	280 mm	1	1949M-30-32

Imperial Double End Offset Flare Nut Wrenches with Chrome Finish



1949Z

3/8x7/16 in	150 mm	1	1949Z-3/8-7/16
1/2x9/16 in	170 mm	1	1949Z-1/2-9/16
5/8x3/4 in	210 mm	1	1949Z-5/8-3/4
3/4x7/8 in	220 mm	1	1949Z-3/4-7/8
1x1 1/8 in	255 mm	1	1949Z-1-1.1/8

1/4" Square Drive Flare Nut Crowfoot Wrenches



679-

7 mm	1/4 in	1	679-7
8 mm	1/4 in	1	679-8
9 mm	1/4 in	1	679-9
10 mm	1/4 in	1	679-10
11 mm	1/4 in	1	679-11
12 mm	1/4 in	1	679-12
13 mm	1/4 in	1	679-13
14 mm	1/4 in	1	679-14
3/8 in	1/4 in	1	679-3/8
7/16 in	1/4 in	1	679-7/16
1/2 in	1/4 in	1	679-1/2
9/16 in	1/4 in	1	679-9/16

3/8" Square Drive Flare Nut Crowfoot Wrenches



749-

10 mm	3/8 in	10	749-10
11 mm	3/8 in	10	749-11
13 mm	3/8 in	10	749-13
14 mm	3/8 in	10	749-14
15 mm	3/8 in	1	749-15
16 mm	3/8 in	1	749-16
17 mm	3/8 in	1	749-17
18 mm	3/8 in	1	749-18
19 mm	3/8 in	1	749-19
20 mm	3/8 in	1	749-20
21 mm	3/8 in	1	749-21
22 mm	3/8 in	1	749-22
23 mm	3/8 in	1	749-23
24 mm	3/8 in	1	749-24
25 mm	3/8 in	1	749-25
26 mm	3/8 in	1	749-26
27 mm	3/8 in	1	749-27
3/8 in	3/8 in	1	749-3/8
7/16 in	3/8 in	1	749-7/16
1/2 in	3/8 in	1	749-1/2
9/16 in	3/8 in	1	749-9/16
5/8 in	3/8 in	1	749-5/8
11/16 in	3/8 in	1	749-11/16
3/4 in	3/8 in	1	749-3/4
13/16 in	3/8 in	1	749-13/16
7/8 in	3/8 in	1	749-7/8
15/16 in	3/8 in	1	749-15/16
1 in	3/8 in	1	749-1
1.1/16 in	3/8 in	1	749-1.1/16
1.1/8 in	3/8 in	1	749-1.1/8
1.3/16 in	3/8 in	1	749-1.3/16
1.1/4 in	3/8 in	1	749-1.1/4
1.5/16 in	3/8 in	1	749-1.5/16
1.3/8 in	3/8 in	1	749-1.3/8
1.7/16 in	3/8 in	1	749-1.7/16
1.1/2 in	3/8 in	1	749-1.1/2
1.9/16 in	3/8 in	1	749-1.9/16
1.5/8 in	3/8 in	1	749-1.5/8
1.11/16 in	3/8 in	1	749-1.11/16
1.3/4 in	3/8 in	1	749-1.3/4
1.13/16 in	3/8 in	1	749-1.13/16
1.7/8 in	3/8 in	1	749-1.7/8
1.15/16 in	3/8 in	1	749-1.15/16
2 in	3/8 in	1	749-2
2.1/8 in	3/8 in	1	749-2.1/8
2.3/16 in	3/8 in	1	749-2.3/16
2.1/4 in	3/8 in	1	749-2.1/4
2.3/8 in	3/8 in	1	749-2.3/8
2.5/8 in	3/8 in	1	749-2.5/8
2.3/4 in	3/8 in	1	749-2.3/4
3.1/8 in	3/8 in	1	749-3.1/8

1/2" Square Drive Flare Nut Crowfoot Wrenches



789-

Icon	Icon	Icon	Icon
28 mm	1/2 in	1	789-28
30 mm	1/2 in	1	789-30
32 mm	1/2 in	1	789-32
34 mm	1/2 in	1	789-34
36 mm	1/2 in	1	789-36
38 mm	1/2 in	1	789-38
40 mm	1/2 in	1	789-40
41 mm	1/2 in	1	789-41
42 mm	1/2 in	1	789-42
46 mm	1/2 in	1	789-46
50 mm	1/2 in	1	789-50
1.1/8 in	1/2 in	1	789-1.1/8
1.1/4 in	1/2 in	1	789-1.1/4
1.5/16 in	1/2 in	1	789-1.5/16
1.3/8 in	1/2 in	1	789-1.3/8
1.7/16 in	1/2 in	1	789-1.7/16
1.1/2 in	1/2 in	1	789-1.1/2
1.9/16 in	1/2 in	1	789-1.9/16
1.5/8 in	1/2 in	1	789-1.5/8
1.3/4 in	1/2 in	1	789-1.3/4
1.13/16 in	1/2 in	1	789-1.13/16
2 in	1/2 in	1	789-2
2.1/4 in	1/2 in	1	789-2.1/4
2.5/16 in	1/2 in	1	789-2.5/16
2.3/8 in	1/2 in	1	789-2.3/8

3/8" Square Drive Crowfoot Adjustable Wrenches



1950MZ

Icon	Icon	Icon	Icon
0-29/0-1.1/8 in	1	1950MZ-3/8	

SLOGGING WRENCHES

Metric Ring End Slogging Wrenches



7444SG-M

Icon	Icon	Icon	Icon
24 mm	1	7444SG-M-24	
27 mm	1	7444SG-M-27	
30 mm	1	7444SG-M-30	
32 mm	1	7444SG-M-32	
34 mm	1	7444SG-M-34	
36 mm	1	7444SG-M-36	
38 mm	1	7444SG-M-38	
41 mm	1	7444SG-M-41	
42 mm	1	7444SG-M-42	
46 mm	1	7444SG-M-46	
50 mm	1	7444SG-M-50	
55 mm	1	7444SG-M-55	
60 mm	1	7444SG-M-60	
65 mm	1	7444SG-M-65	
70 mm	1	7444SG-M-70	
75 mm	1	7444SG-M-75	
80 mm	1	7444SG-M-80	
85 mm	1	7444SG-M-85	
90 mm	1	7444SG-M-90	
95 mm	1	7444SG-M-95	
100 mm	1	7444SG-M-100	
105 mm	1	7444SG-M-105	
110 mm	1	7444SG-M-110	
115 mm	1	7444SG-M-115	
120 mm	1	7444SG-M-120	
125 mm	1	7444SG-M-125	
130 mm	1	7444SG-M-130	
135 mm	1	7444SG-M-135	
140 mm	1	7444SG-M-140	
145 mm	1	7444SG-M-145	
150 mm	1	7444SG-M-150	
155 mm	1	7444SG-M-155	
160 mm	1	7444SG-M-160	
165 mm	1	7444SG-M-165	
170 mm	1	7444SG-M-170	
175 mm	1	7444SG-M-175	

Imperial Ring End Slogging Wrenches



7444SG-Z

Icon	Icon	Icon	Icon
1 1/16 in	1	7444SG-Z-1.1/16	
1 1/8 in	1	7444SG-Z-1.1/8	
1 3/16 in	1	7444SG-Z-1.3/16	



1 1/4 in	1	7444SG-Z-1.1/4	
1 5/16 in	1	7444SG-Z-1.5/16	
1 3/8 in	1	7444SG-Z-1.3/8	
1 7/16 in	1	7444SG-Z-1.7/16	
1 5/8 in	1	7444SG-Z-1.5/8	
1 11/16 in	1	7444SG-Z-1.11/16	
1 3/4 in	1	7444SG-Z-1.3/4	
1 13/16 in	1	7444SG-Z-1.13/16*	
1 7/8 in	1	7444SG-Z-1.7/8	
2 in	1	7444SG-Z-2	
2 1/16 in	1	7444SG-Z-2.1/16	
2 1/8 in	1	7444SG-Z-2.1/8	
2 3/16 in	1	7444SG-Z-2.3/16	
2 1/4 in	1	7444SG-Z-2.1/4	
2 3/8 in	1	7444SG-Z-2.3/8	
2 9/16 in	1	7444SG-Z-2.9/16	
2 5/8 in	1	7444SG-Z-2.5/8	
2 3/4 in	1	7444SG-Z-2.3/4	
3 in	1	7444SG-Z-3	
3 1/8 in	1	7444SG-Z-3.1/8	
3 3/8 in	1	7444SG-Z-3.3/8	
3 1/2 in	1	7444SG-Z-3.1/2	
3 3/4 in	1	7444SG-Z-3.3/4	
3 7/8 in	1	7444SG-Z-3.7/8	
4 in	1	7444SG-Z-4	
4 1/8 in	1	7444SG-Z-4.1/8	
4 1/2 in	1	7444SG-Z-4.1/2	

Metric Open End Slogging Wrenches



133SGM

Icon	Icon	Icon	Icon
27 mm	1	133SGM-27	
30 mm	1	133SGM-30	
32 mm	1	133SGM-32	
36 mm	1	133SGM-36	
41 mm	1	133SGM-41	
46 mm	1	133SGM-46	
50 mm	1	133SGM-50	
55 mm	1	133SGM-55	
60 mm	1	133SGM-60	
65 mm	1	133SGM-65	
70 mm	1	133SGM-70	
75 mm	1	133SGM-75	
80 mm	1	133SGM-80	
85 mm	1	133SGM-85	
90 mm	1	133SGM-90	
95 mm	1	133SGM-95	
100 mm	1	133SGM-100	
105 mm	1	133SGM-105	
110 mm	1	133SGM-110	
115 mm	1	133SGM-115	
120 mm	1	133SGM-120	

* Until stocks last



Metric Deep Offset Ring End Slogging Wrenches



315M

Size	Quantity	Part Number
27 mm	1	315M-27
30 mm	1	315M-30
32 mm	1	315M-32
36 mm	1	315M-36
41 mm	1	315M-41
46 mm	1	315M-46
50 mm	1	315M-50
55 mm	1	315M-55
60 mm	1	315M-60
65 mm	1	315M-65
70 mm	1	315M-70
75 mm	1	315M-75
80 mm	1	315M-80

Imperial Deep Offset Ring End Slogging Wrenches



315Z

Size	Quantity	Part Number
1.1/16 in	1	315Z-1.1/16
1.1/8 in	1	315Z-1.1/8
1.3/16 in	1	315Z-1.3/16
1.1/4 in	1	315Z-1.1/4
1.5/16 in	1	315Z-1.5/16
1.3/8 in	1	315Z-1.3/8
1.7/16 in	1	315Z-1.7/16
1.1/2 in	1	315Z-1.1/2
1.5/8 in	1	315Z-1.5/8
1.11/16 in	1	315Z-1.11/16
1.3/4 in	1	315Z-1.3/4
1.13/16 in	1	315Z-1.13/16
1.7/8 in	1	315Z-1.7/8
1.15/16 in	1	315Z-1.15/16
2 mm	1	315Z-2
2.1/16 in	1	315Z-2.1/16
2.1/8 in	1	315Z-2.1/8
2.3/16 in	1	315Z-2.3/16
2.1/4 in	1	315Z-2.1/4
2.5/16 in	1	315Z-2.5/16
2.3/8 in	1	315Z-2.3/8
2.1/2 in	1	315Z-2.1/2
2.9/16 in	1	315Z-2.9/16

Size	Quantity	Part Number
2.5/8 in	1	315Z-2.5/8
2.3/4 in	1	315Z-2.3/4
2.7/8 in	1	315Z-2.7/8
2.15/16 in	1	315Z-2.15/16
3 mm	1	315Z-3
3.1/8 in	1	315Z-3.1/8

Metric Deep Offset Heavy Duty Ring End Wrenches



310M

Size	Quantity	Part Number
24 mm	1	310M-24
27 mm	1	310M-27
30 mm	1	310M-30
32 mm	1	310M-32
36 mm	1	310M-36
38 mm	1	310M-38
41 mm	1	310M-41
46 mm	1	310M-46
50 mm	1	310M-50
55 mm	1	310M-55
60 mm	1	310M-60
65 mm	1	310M-65
70 mm	1	310M-70
75 mm	1	310M-75
80 mm	1	310M-80
85 mm	1	310M-85
90 mm	1	310M-90
95 mm	1	310M-95

Extension Tubular Handles for 310M Ring Wrench



R310

Size 1	Size 2	Quantity	Part Number
24-30 mm	19 mm	1	R310-0
32-41 mm	22 mm	1	R310-1
46-55 mm	25 mm	1	R310-2
60-95 mm	30 mm	1	R310-3

SOCKET WRENCHES

Metric Double Head Offset Socket Wrenches with 12 x 6-Point Dynamic-Drive™



28M

Size 1	Size 2	Quantity	Part Number
6 mm	6 mm	5	28M-6
7 mm	7 mm	5	28M-7
8 mm	8 mm	5	28M-8
9 mm	9 mm	5	28M-9
10 mm	10 mm	5	28M-10
11 mm	11 mm	5	28M-11
12 mm	12 mm	5	28M-12
13 mm	13 mm	5	28M-13
14 mm	14 mm	5	28M-14
15 mm	15 mm	5	28M-15
16 mm	16 mm	5	28M-16
17 mm	17 mm	5	28M-17
18 mm	18 mm	3	28M-18
19 mm	19 mm	3	28M-19
20 mm	20 mm	3	28M-20
21 mm	21 mm	3	28M-21
22 mm	22 mm	3	28M-22
23 mm	23 mm	3	28M-23
24 mm	24 mm	3	28M-24
25 mm	25 mm	3	28M-25
26 mm	26 mm	3	28M-26
27 mm	27 mm	3	28M-27
28 mm	28 mm	1	28M-28
29 mm	29 mm	1	28M-29
30 mm	30 mm	1	28M-30
32 mm	32 mm	1	28M-32
6 mm	6 mm	10	SB28M-6
7 mm	7 mm	10	SB28M-7
8 mm	8 mm	10	SB28M-8
9 mm	9 mm	10	SB28M-9
10 mm	10 mm	10	SB28M-10
11 mm	11 mm	10	SB28M-11
12 mm	12 mm	10	SB28M-12
13 mm	13 mm	10	SB28M-13
14 mm	14 mm	10	SB28M-14
15 mm	15 mm	10	SB28M-15
16 mm	16 mm	5	SB28M-16
17 mm	17 mm	5	SB28M-17
18 mm	18 mm	5	SB28M-18
19 mm	19 mm	5	SB28M-19
20 mm	20 mm	4	SB28M-20
21 mm	21 mm	4	SB28M-21
22 mm	22 mm	4	SB28M-22
23 mm	23 mm	4	SB28M-23
24 mm	24 mm	4	SB28M-24

Metric Double Head Offset Socket Wrenches with 6 x 6-Point Dynamic-Drive™



29M

Size	Quantity	Part Number
6 mm	5	29M-6
7 mm	5	29M-7
8 mm	5	29M-8
9 mm	5	29M-9
10 mm	5	29M-10
11 mm	5	29M-11
12 mm	5	29M-12
13 mm	5	29M-13
14 mm	5	29M-14
15 mm	5	29M-15
16 mm	5	29M-16
17 mm	5	29M-17
18 mm	3	29M-18
19 mm	3	29M-19
20 mm	3	29M-20
21 mm	3	29M-21
22 mm	3	29M-22
23 mm	3	29M-23
24 mm	3	29M-24
25 mm	3	29M-25
26 mm	3	29M-26
27 mm	3	29M-27
28 mm	1	29M-28
29 mm	1	29M-29
30 mm	1	29M-30
32 mm	1	29M-32

Metric Double Head Offset Socket Wrench Set with 12 x 6-Point Dynamic-Drive™ - 11 Pcs



28M/11

11	1	28M/11
----	---	--------

28M-8, 28M-9, 28M-10, 28M-11, 28M-13, 28M-12, 28M-14, 28M-15, 28M-17, 28M-19, 28M-22

Metric Double Head Offset Socket Wrench Set with 6 x 6-Point Dynamic-Drive™ - 8 Pcs



29M/

8	1	29M/8
---	---	-------

29M-8, 29M-10, 29M-12, 29M-13, 29M-14, 29M-17, 29M-19, 29M-22

Metric Double Head Offset Socket Wrench Set with 12 x 6-Point Dynamic-Drive™ - 12 Pcs



28M/12

12	1	28M/12
----	---	--------

28M-8, 28M-9, 28M-10, 28M-11, 28M-12, 28M-13, 28M-14, 28M-15, 28M-16, 28M-17, 28M-18, 28M-19

Metric Double Head Offset Socket Wrench Set with 6 x 6-Point Dynamic-Drive™ - 10 Pcs



29M/10

10	1	29M/10
----	---	--------

29M-8, 29M-10, 29M-11, 29M-12, 29M-13, 29M-14, 29M-16, 29M-17, 29M-18, 29M-19

Metric Double Head Offset Socket Wrench Set with 12 x 6-Point Dynamic-Drive™ - 8 Pcs



28M/

8	1	28M/8
---	---	-------

28M-8, 28M-10, 28M-11, 28M-13, 28M-16, 28M-17, 28M-18, 28M-19

Metric Double Head Offset Socket Wrench Set with 12 x 6-Point Dynamic-Drive™ - 15 Pcs



28M/15

15	1	28M/15
----	---	--------

28M-8, 28M-9, 28M-10, 28M-11, 28M-12, 28M-13, 28M-14, 28M-15, 28M-16, 28M-17, 28M-18, 28M-19, 28M-21, 28M-22, 28M-24

Metric Double Head Offset Socket Wrench Set with 6 x 6-Point Dynamic-Drive™ - 14 Pcs



29M/14

14	1	29M/14
----	---	--------

29M-11, 29M-12, 29M-13, 29M-14, 29M-8, 29M-9, 29M-10, 29M-16, 29M-17, 29M-21, 29M-22, 29M-19, 29M-24, 29M-23



Metric Tubular Double Head Socket Wrench



1936M

Size	Quantity	Part Number
6x7 mm	50	1936M-6-7
8x9 mm	5	1936M-8-9
8x10 mm	30	1936M-8-10
10x11 mm	25	1936M-10-11
10x13 mm	25	1936M-10-13
12x13 mm	25	1936M-12-13
13x17 mm	20	1936M-13-17
14x15 mm	20	1936M-14-15
14x17 mm	15	1936M-14-17
16x17 mm	15	1936M-16-17
17x19 mm	10	1936M-17-19
18x19 mm	10	1936M-18-19
19x22 mm	8	1936M-19-22
20x22 mm	8	1936M-20-22
21x23 mm	8	1936M-21-23
22x24 mm	5	1936M-22-24
24x26 mm	5	1936M-24-26
24x27 mm	5	1936M-24-27
25x28 mm	5	1936M-25-28
30x32 mm	1	1936M-30-32
30x34 mm	4	1936M-30-34
36x41 mm	4	1936M-36-41
46x50 mm	2	1936M-46-50

Size	Quantity	Part Number
24x27* mm	5	27M-24-27
25x28* mm	5	27M-25-28
27x29* mm	5	27M-27-29
30x32* mm	5	27M-30-32
6x7 mm	10	SB27M-6-7
8x9 mm	10	SB27M-8-9
10x11 mm	10	SB27M-10-11
12x13 mm	10	SB27M-12-13
14x15 mm	10	SB27M-14-15
16x17* mm	10	SB27M-16-17
18x19* mm	10	SB27M-18-19
20x22* mm	10	SB27M-20-22
21x23* mm	5	SB27M-21-23
24x26* mm	5	SB27M-24-26

Sizes marked with * in the table have a hole along the shank

Metric Tubular Double Head Socket Wrench Set with Chrome Finish - 7 Pcs



1936M/

Size	Quantity	Part Number
7	1	1936M/7

Part Number	Quantity
1936M-8-9, 1936M-10-11, 1936M-12-13, 1936M-14-15, 1936M-16-17, 1936M-18-19, 1936M-20-22	1
26S-610	1

Metric Double Head Socket Wrenches with Chrome Finish



27M

Size	Quantity	Part Number
6x7 mm	10	27M-6-7
8x9 mm	10	27M-8-9
10x11 mm	10	27M-10-11
12x13 mm	10	27M-12-13
13x17* mm	10	27M-13-17
14x15 mm	10	27M-14-15
16x17* mm	10	27M-16-17
16x18* mm	10	27M-16-18
18x19* mm	10	27M-18-19
20x22* mm	10	27M-20-22
21x23* mm	5	27M-21-23
21x24* mm	5	27M-21-24
24x26* mm	5	27M-24-26

Metric Tubular Double Head Socket Wrench Set with Chrome Finish - 12 Pcs



1936M/12

Size	Quantity	Part Number
12	1	1936M/12

Part Number	Quantity
1936M-6-7, 1936M-8-9, 1936M-10-11, 1936M-12-13, 1936M-14-15, 1936M-16-17, 1936M-18-19, 1936M-20-22, 1936M-21-23, 1936M-24-27, 1936M-25-28, 1936M-30-32	1
26S-610, 26S-1216, 26S-16	1

Metric Double Head Socket Wrench Set - 8 Pcs/Plastic Pouch



27M/T

Size	Quantity	Part Number
8	1	27M/8T

Part Number	Quantity
27M-6-7, 27M-8-9, 27M-10-11, 27M-12-13, 27M-14-15, 27M-16-17, 27M-18-19, 27M-20-22	1

Metric Double Head Socket Wrench Set - 12 Pcs/Plastic Pouch



27M/12T

Size	Quantity	Part Number
12	1	27M/12T

Part Number	Quantity
27M-6-7, 27M-8-9, 27M-10-11, 27M-12-13, 27M-14-15, 27M-16-17, 27M-18-19, 27M-20-22, 27M-21-23, 27M-24-26, 27M-25-28, 27M-30-32	1

Metric Double Head Socket Wrench Set - 6 Pcs/Cardboard Box



27M/

Size	Quantity	Part Number
6	1	27M/6

Part Number	Quantity
27M-6-7, 27M-8-9, 27M-10-11, 27M-12-13, 27M-14-15, 27M-16-17	1

Metric Double Head Socket Wrench Set - 8 Pcs/Cardboard Box



27M/8



8



1 27M/8

27M-6-7, 27M-8-9, 27M-10-11, 27M-12-13, 27M-14-15, 27M-16-17, 27M-18-19, 27M-20-22



Metric Double Head Socket Wrench Set - 10 Pcs/Cardboard Box



27M/10



10



1 27M/10

27M-6-7, 27M-8-9, 27M-10-11, 27M-12-13, 27M-14-15, 27M-16-17, 27M-18-19, 27M-20-22, 27M-21-23, 27M-24-26



Metric Double Head Socket Wrench Set - 12 Pcs/Cardboard Box



27M/12



12



1 27M/12

27M-6-7, 27M-8-9, 27M-10-11, 27M-12-13, 27M-14-15, 27M-16-17, 27M-18-19, 27M-20-22, 27M-21-23, 27M-24-26, 27M-25-28, 27M-30-32



Stepped Tommy Bars with Chrome Finish



26S



6 8 10 mm
12 14 mm
16 mm



10 26S-610
8 26S-1216
5 26S-16

Metric Swivel Head Double End Wrenches with Bi-Hex Socket



4040M



6x7 mm
8x9 mm
10x11 mm
10x13 mm
12x13 mm
13x17 mm
14x15 mm
16x17 mm
16x18 mm
18x19 mm
20x22 mm
21x23 mm
24x27 mm



1 4040M-6-7
1 4040M-8-9
1 4040M-10-11
1 4040M-10-13
1 4040M-12-13
1 4040M-13-17*
1 4040M-14-15
1 4040M-16-17
1 4040M-16-18*
1 4040M-18-19
1 4040M-20-22*
1 4040M-21-23*
1 4040M-24-27

Metric Double Ended Swivel Head Wrench Set with Bi-Hex Socket



4040M/S6



6



1 4040M/S6

4040M-8-9, 4040M-10-11, 4040M-12-13, 4040M-14-15, 4040M-16-17, 4040M-18-19



Metric Double Ended Swivel Head Wrench Set with Bi-Hex Socket Plastic Wallet



4040M/6T



6



1 4040M/6T

4040M-8-9, 4040M-10-11, 4040M-12-13, 4040M-14-15, 4040M-16-17, 4040M-18-19



* Until stocks last

Imperial Swivel Head Double End Wrenches with Bi-Hex Socket



4040Z



3/8x7/16 in
1/2x9/16 in
5/8x11/16 in
5/8x3/4 in
13/16x7/8 in



1 4040Z-3/8-7/16*
1 4040Z-1/2-9/16*
1 4040Z-5/8-11/16*
1 4040Z-5/8-3/4*
1 4040Z-13/16-7/8*

MULTIFITTING KEYS

5-in-1 Switch Cabinet Wrenches



MK5



97x25 mm



1 MK5

Square: 5,6,7-8 mm, Triangular: 9 mm Two-way-key: 3-5 mm



9-in-1 Switch Cabinet Wrenches



MK9

95x95 mm	25	MK9
Square: 5,6,7-8,9-10 mm, Triangular:7,8-9,10-11 mm Two-way-key: 3-5 mm Half-moon: 6 mm		

HOOK WRENCHES

Flexible Head Adjustable Hook Wrenches with Chrome Finish



4106

19-50 mm	10	4106-19-50
20-35 mm	1	4106-20-35*
32-75 mm	25	4106-32-75
50-120 mm	25	4106-50-120
115-165 mm	25	4106-115-165
150-230 mm	10	4106-150-230

Adjustable Pin Hook Wrenches with Chrome Finish



40B

19-50 mm	25	40B-19-50
22-35 mm	1	40B-22-35*
32-75 mm	25	40B-32-75
50-120 mm	20	40B-50-120
115-165 mm	25	40B-115-165
150-230 mm	10	40B-150-230
165-230 mm	1	40B-165-230*

Spare Pin for Adjustable Pin Hook Wrenches



40B-SP

40B-19-50	1	40B-19-50-SP
40B-32-75	1	40B-32-75-SP
40B-50-120	1	40B-50-120-SP
40B-115-165	1	40B-115-165-SP

Adjustable Pin Wrenches with Chrome Finish



4307/4310

10-50 mm	1	4307
22-100 mm	1	4310



Sockets & Ratchets



SOCKET SETS

1/4" and 1/2" Square Drive Socket and Deep Socket Set with Metric Hex Profile and Combination Spanner Set



S910



110 x 320 x 375 mm

2 S910

1/4" and 1/2" Square Drive Socket Set with Combination Spanner Set/L-Keys



S106



110 x 430 x 375 mm

2 S106

1/4" and 1/2" Square Drive Socket Set with Metric Hex Profile and Combination Wrench/Bit Set/Pliers



S81MIX



110 x 430 x 375 mm

2 S81MIX

Socket Set with Combination Wrenches, Hex L-Keys and Bits - 96 Pcs



S95



110 x 320 x 375 mm

2 S95

1/4" and 1/2" Square Drive Socket Set with Combination Spanner Set



S103



110 x 375 x 430 mm

2 S103

1/2" Square Drive Socket Set with Metric Hex Profile and Combination Wrenches/Bit Set/Hammer/Pliers - 71 Pcs



S71MIX



110 x 430 x 375 mm

2 S71MIX

1 ratchet screwdriver

1/4" and 1/2" Square Drive Combination Spanner and Socket Set



S87+7



110 x 430 x 375 mm

2 S87+7

1 pce removable three section plastic box with lid

1/4" and 1/2" Square Drive Socket Set with Combination Spanner Set/Socket Drivers



S108



110 x 430 x 375 mm

2 S108

1/4" and 1/2" Square Drive Socket Set with Metric Hex Profile and Combination Spanner Set



S410



110 x 320 x 375 mm

2 S410

1/4" and 1/2" Square Drive Spanner and Socket Set



S800



110 x 375 x 430 mm



2 S800

1/4" and 3/8" Square Drive Socket Set with Metric Hex Profile and Slim Head Ratchet - 91 Pcs



SL91



100 x 215 x 370 mm



4 SL91*

1/4" - 3/8" - 1/2" Square Drive Socket Set with Metric Hex Profile with Gear Wrenches Set - 137 Pcs



S137



105 x 370 x 430 mm



2 S137

1/4" and 1/2" Square Drive Socket Set with Metric Hex Profile and Swivel Head Ratchet - 79 Pcs



SW79



100 x 215 x 370 mm



4 SW79

1/4" and 3/8" Square Drive Socket Set with Metric Hex Profile and Swivel Head Ratchet - 91 Pcs



SW91



100 x 215 x 370 mm



4 SW91*

1/4" Square Drive Deep Socket Set with Metric Hex Profile



S0810L



35 x 85 x 160 mm



20 S0810L

1/4" and 1/2" Square Drive Socket Set with Metric Bi-Hex Profile and Slim Head Ratchet



S560



100 x 215 x 375 mm



4 S560

1/4" 3/8" and 1/2" Square Drive Socket Set with Combination Wrenches/Screwdriver Bits



S138



110 x 375 x 430 mm



2 S138

1/4" Square Drive Socket Set with Metric Hex Profile and Screwdriver Bits/Bit Holder



SL25



35 x 85 x 160 mm



20 SL25

* Until stocks last



1/4" Square Drive Socket Set with Metric Bi-hex Profile and Screwdriver Bits/Bit Holder - 39 Pcs



S39MH



1/4" bi-hex 6,7,8,10,11,13; 1/4" ratchet; 1/4" adaptor; 1/4" bit holder; 1/4" PH1, PH2, PH3; 1/4" PZ1, PZ2, PZ3; 1/4" H3, H4, H5, H6; 1/4" 4, 4.5, 6, 5.5, 8; 1/4" T8, T10, T15, T20, T25, T27, T30, T40; 1/4" TR10, TR15, TR20, TR25, TR27, TR30, TR40

1/4" Square Drive Socket Set with Metric Hex Profile and Screwdriver Bits



SL24



35 x 85 x 160 mm 30 SL24

1/4" Square Drive Socket Set with Metric Hex Profile and Ratchet



S160



70 x 160 x 280 mm 6 S160

1/4" Square Drive Socket Set with Metric Bi-hex Profile and Screwdriver Bits/Bit Holder Retail Pack- 39 Pcs



SBS39MH



SB: Retail pack 1/4" bi-hex 6,7,8,10,11,13; 1/4" ratchet; 1/4" adaptor; 1/4" bit holder; 1/4" PH1, PH2, PH3; 1/4" PZ1, PZ2, PZ3; 1/4" H3, H4, H5, H6; 1/4" 4, 4.5, 6, 5.5, 8; 1/4" T8, T10, T15, T20, T25, T27, T30, T40; 1/4" TR10, TR15, TR20, TR25, TR27, TR30, TR40

1/4" Square Drive Socket and Deep Socket Set with Metric Hex Profile and Screwdriver Bits



SL25L



46 x 130 x 195 mm 10 SL25L

1/4" Square Drive Socket Set with Metric Hex Profile and Ratchet/Socket Drivers



S290



70 x 160 x 280 mm 6 S290

1/4" Square Drive Socket Set with Metric Hex Profile and Screwdriver Bits/Bit Holder, 25 Pcs/Case Retail Pack



SBSL25



SB: Retail pack

1/4" Square Drive Socket and Deep Socket Set with Metric Hex Profile and Screwdriver Bits - 37 Pcs/Case Retail Pack



SBSL25L



12-1/4" hex sockets 4, 4.5, 5, 5.5, 6, 7, 8, 9, 10, 11, 12, 13 mm; 10-1/4" hex deep sockets 4, 5, 6, 7, 8, 9, 10, 11, 12, 13 mm; 1-1/4" ratchet; 2-1/4" bits PH2; 1-1/4" bit PZ2; 3 bit hex 4, 5, 6 mm; 6-TORX bits T10, T15, T20, T25, T30, T40; 1-1/4" bit holder; 1-1/4" wobbler extension bar 100 mm

1/4" Square Drive Socket Set with Metric Hex Profile and Socket Drivers



S460



100 x 215 x 375 mm 6 S460

1/4" Square Drive Socket Set with Metric Hex Profile and Slim Head Ratchet - 65 Pcs



SL65



70 x 160 x 280 mm



6 SL65

1/4" Square Drive Socket Set with Metric Hex Profile and Swivel Head Ratchet - 65 Pcs



SW65



70 x 160 x 280 mm



6 SW65

1/4" Square Drive Socket Set with Imperial Hex Profile and Screwdriver Bits/Bit Holder



SL25AF



35 x 85 x 165 mm



20 SL25AF

1/4" Square Drive Socket Set with Imperial Hex Profile and Ratchet



S160AF



70 x 160 x 280 mm



6 S160AF

1/4" Square Drive Socket Set with Metric Hex Profile and Round Head Ratchet



6712RN



31 x 108 x 178 mm



1 6712RN

6700SM-4, 6700SM-5, 6700SM-5.5, 6700SM-6, 6700SM-7, 6700SM-8, 6700SM-10, 6700SM-11, 6700SM-13

6960, 6962, 6960-6

6950RN

4750BMC3



1/4" Square Drive Socket Set with Metric Bi-Hex Profile and Pear Head Ratchet



A6716DM



35 x 111 x 223 mm



1 A6716DM

A6700DM-5.5, A6700DM-6, A6700DM-7, A6700DM-8, A6700DM-9, A6700DM-10, A6700DM-11, A6700DM-12, A6700DM-13, A6700DM-14

6956

6962, 6960-6

6966

6954-5

6950

4750BMC4



1/4" Square Drive Socket Set with Metric Hex Profile and Round Head Ratchet/ Extension Bars



6715MGS



34 x 113 x 223 mm



1 6715MGS

SB6700SM-4, 6700SM-4.5, 6700SM-5, 6700SM-5.5, 6700SM-6, 6700SM-6, 6700SM-7, 6700SM-8, 6700SM-9, 6700SM-10, 6700SM-11, 6700SM-13

6954-5

6950RN

6956

6966

6962, 6960-6



1/4" Square Drive Socket Set with Metric Hex Profile and Round Head Ratchet/T-Handle



6719MHR

50 x 110 x 220 mm	1	6719MHR

6700SM-4, 6700SM-4.5, 6700SM-5.5, 6700SM-6, 6700SM-7, 6700SM-8, 6700SM-9, 6700SM-10, 6700SM-11, 6700SM-12, 6700SM-13, 6700SM-14		
6950RN		
6960, 6962, 6960-6		
6954-5		
6956		
6966		

1/4" Square Drive Socket Set with Metric Hex Profile and Round Head Ratchet/Screwdriver Bits/Adaptor



6729MHR

50 x 110 x 220 mm	1	6729MHR

6700SM-4, 6700SM-5, 6700SM-6, 6700SM-7, 6700SM-8, 6700SM-9, 6700SM-10, 6700SM-11, 6700SM-13, 6700SM-14		
6950RN		
6960, 6962, 6960-6		
6966		
6956		
6973A		
59S/PH1, 59S/PH2, 59S/PH3		
59S/PZ1, 59S/PZ2, 59S/PZ3		
59S/0.6-4.5, 59S/0.8-5.5, 59S/1.2-6.5		
59S/H3, 59S/H4, 59S/H5, 59S/H6		

1/4" Square Drive Socket Set with Metric Hex Profile and Pear Head Ratchet/Screwdriver Bits/Adaptor



6729MHP

50 x 110 x 220 mm	1	6729MHP

6700SM-4, 6700SM-5, 6700SM-6, 6700SM-7, 6700SM-8, 6700SM-9, 6700SM-10, 6700SM-11, 6700SM-13, 6700SM-14		
6950		
6960, 6962, 6960-6		
6966		
6956		
6973A		
59S/0.6-4.5, 59S/0.8-5.5, 59S/1.2-6.5		
59S/PZ1, 59S/PZ2, 59S/PZ3		
59S/PH1, 59S/PH2, 59S/PH3		
59S/H3, 59S/H4, 59S/H5, 59S/H6		

1/4" Square Drive Socket Set with Metric Bi-Hex Profile and Pear Head Ratchet/Extension Bars



6717MBP

50 x 110 x 220 mm	1	6717MBP

A6700DM-5, A6700DM-5.5, A6700DM-6, A6700DM-7, A6700DM-8, A6700DM-9, A6700DM-10, A6700DM-11, A6700DM-12, A6700DM-13, A6700DM-14		
6950		
6960, 6962, 6960-6		
6954-5		
6966		
6956		

1/4" Square Drive Socket Set with Metric Bi-Hex Profile and Pear Head Ratchet/Screwdriver Bits



6730MBP

50 x 110 x 220 mm	1	6730MBP

A6700DM-5, A6700DM-5.5, A6700DM-6, A6700DM-7, A6700DM-8, A6700DM-9, A6700DM-10, A6700DM-11, A6700DM-12, A6700DM-13, A6700DM-14		
6950		
6960, 6962, 6960-6		
6954-5		
6966		
6956		
6973A		
59S/0.6-4.5, 59S/1.2-6.5, 59S/0.8-5.5		
59S/PH1, 59S/PH2, 59S/PH3		
59S/PZ1, 59S/PZ2, 59S/PZ3		
59S/H3, 59S/H4, 59S/H5, 59S/H6		

1/4" Square Drive Socket Set with Metric Hex Profile and Pear Head Ratchet/Universal Joint



6719SM

41 x 113 x 223 mm	1	6719SM

6700SM-4, 6700SM-4.5, 6700SM-5, 6700SM-5.5, 6700SM-6, 6700SM-7, 6700SM-8, 6700SM-9, 6700SM-10, 6700SM-11, 6700SM-12, 6700SM-13		
6954-5		
6950		
6956		
6966		
6962, 6960-6		

1/4" Square Drive Socket Set with Metric Hex Profile and Round Head Ratchet/Breaker Bar



6715MG



35 x 111 x 223 mm



1 6715MG

6700SM-4, 6700SM-4.5, 6700SM-5, 6700SM-5.5, 6700SM-6, 6700SM-7, 6700SM-8, 6700SM-9, 6700SM-10, 6700SM-11, 6700SM-12, 6700SM-13, 6700SM-14



6954-5



6958



6956



6962, 6960, 6960-6



6966



6950RN



1/4" Square Drive Socket Set with Metric Hex Profile and Pear Head Ratchet/Extension Bars



6722M



41 x 113 x 223 mm



1 6722M

6700SM-4, 6700SM-5, 6700SM-6, 6700SM-7, 6700SM-8, 6700SM-9, 6700SM-10, 6700SM-11, 6700SM-13, 6700SM-14



6954-5



6956



6950



6966



6960, 6962, 6960-6



6972H



59S/H3, 59S/H4, 59S/H5, 59S/H6



59S/PH1, 59S/PH2, 59S/PH3



1/4" Square Drive Socket Set with Metric Hex Profile and Pear Head Ratchet/Socket Drivers



6715PZ



41 x 113 x 223 mm



1 6715PZ

6700SM-4, 6700SM-4.5, 6700SM-5, 6700SM-5.5, 6700SM-6, 6700SM-7, 6700SM-8, 6700SM-9, 6700SM-10, 6700SM-11, 6700SM-12, 6700SM-13



6956



6950



6954-5



6962, 6960, 6960-6



6966



6709F-4.5, 6709F-5.5, 6709F-8



6709M-3, 6709M-4, 6709M-5, 6709M-6, 6709M-8



6709PZ-1, 6709PZ-3, 6709PZ-2



1/4" Square Drive Socket Set with Metric Hex Profile and Pear Head Ratchet/Adaptor



6721NM



41 x 113 x 223 mm



1 6721NM

6700SM-4, 6700SM-4.5, 6700SM-5, 6700SM-5.5, 6700SM-6, 6700SM-7, 6700SM-8, 6700SM-9, 6700SM-10, 6700SM-11, 6700SM-12, 6700SM-13, 6700SM-14



6954-5



6951



6956



6950



6962, 6960, 6960-6



6966



6958



1/4" Square Drive Socket Set with Metric Hex Profile and Round Head Ratchet/Spinner Handle



6715GE



31 x 113 x 223 mm



1 6715GE

6700SM-4, 6700SM-5, 6700SM-6, 6700SM-7, 6700SM-8, 6700SM-9, 6700SM-10, 6700SM-11, 6700SM-13, 6700SM-14



6956



6950RN



6954-5



6966



6960, 6962, 6960-6



6972H



59S/H3, 59S/H4, 59S/H5, 59S/H6



59S/PH1, 59S/PH2, 59S/PH3



1/4" Square Drive Socket Set with Metric Hex Profile and Pear Head Ratchet/Screwdriver Bits



6715GJ



50 x 113 x 223 mm



1 6715GJ

6700SM-4, 6700SM-4.5, 6700SM-5, 6700SM-5.5, 6700SM-6, 6700SM-7, 6700SM-8, 6700SM-9, 6700SM-10, 6700SM-11, 6700SM-12, 6700SM-13



6956



6962, 6960, 6960-6



6709F-4.5, 6709F-5.5, 6709F-8



6709M-5, 6709M-6, 6709M-8, 6709M-4, 6709M-3



6954-5



6950



6966



6709PH-1, 6709PH-2, 6709PH-3



1/4" Square Drive Socket Set with Metric Hex Profile and Pear Head Ratchet/Spinner Set



6720NM



43 x 114 x 351 mm

1 6720NM

6700SM-4, 6700SM-4.5, 6700SM-5, 6700SM-5.5, 6700SM-6, 6700SM-7, 6700SM-8, 6700SM-9, 6700SM-10, 6700SM-11, 6700SM-12, 6700SM-13, 6700SM-14

1931M-4, 1931M-4.5, 1931M-9, 1931M-10, 1931M-11, 1931M-14, 1931M-13, 1931M-12, 1931M-7, 1931M-8, 1931M-6, 1931M-5.5, 1931M-5

6954-5

6950

6956

221 D

73721-3-80

6966

6962, 6960-6

1/4" Socket Set with Imperial Bi-Hex Profile - 18 Pcs



A6718DZ



41 x 113 x 223 mm

1 A6718DZ

6950

6951

6956

6954-5

6958

6960, 6962, 6960-6

6966

A6700DZ-3/16, A6700DZ-7/32, A6700DZ-1/4, A6700DZ-9/32, A6700DZ-5/16, A6700DZ-11/32, A6700DZ-3/8, A6700DZ-7/16, A6700DZ-1/2, A6700DZ-9/16

1/4" Square Drive Deep Socket 9-piece set for Metric and imperial Hex Head Screw



A6709MZ/9



46 x 130 x 195 mm

1 A6709MZ/9

A6709M-2.5, A6709M-3, A6709M-4, A6709M-5, A6709M-6

A6709Z-1/8, A6709Z-9/64, A6709Z-5/32, A6709Z-3/16

SPAR-CASE-A6

1/4" Square Drive Socket Set with Imperial Bi-Hex Profile and Pear Head Ratchet



A6716DZ



41 x 113 x 223 mm

1 A6716DZ

A6700DZ-3/16, A6700DZ-7/32, A6700DZ-1/4, A6700DZ-9/32, A6700DZ-5/16, A6700DZ-11/32, A6700DZ-3/8, A6700DZ-7/16, A6700DZ-1/2, A6700DZ-9/16

6956

6962, 6960-6

6966

6954-5

6950

4750BMC4

1/4" Square Drive Socket Set with Metric/Imperial Hex Profile and Pear Head Ratchet



6715MZ



40 x 126 x 230 mm

1 6715MZ

6700SM-4, 6700SM-4.5, 6700SM-5, 6700SM-5.5, 6700SM-6, 6700SM-8, 6700SM-9, 6700SM-10, 6700SM-11, 6700SM-13

6700SZ-7/32, 6700SZ-3/16, 6700SZ-1/4, 6700SZ-9/32, 6700SZ-5/16, 6700SZ-11/32, 6700SZ-3/8, 6700SZ-7/16, 6700SZ-1/2

6954-5

6950

6956

6966

6962, 6960-6

1/4" Square Drive Socket Set with Metric Hex Profile and Spinner Handle



6729SM



25 x 55 x 190 mm

1 6729SM

6700SM-4, 6700SM-4.5, 6700SM-5, 6700SM-5.5, 6700SM-6, 6700SM-7, 6700SM-8, 6700SM-9, 6700SM-10, 6700SM-11, 6700SM-12, 6700SM-13, 6700SM-14

6956

1/4" Square Drive Socket Set with Imperial Hex Profile and Spinner Handle



6729SZ



25 x 55 x 190 mm

1 6729SZ

6700SZ-1/4, 6700SZ-11/32, 6700SZ-1/2, 6700SZ-3/16, 6700SZ-7/32, 6700SZ-3/8, 6700SZ-7/16

6956

1/4" Square Drive Socket Set with Metric Hex Profile



6713MH

13	260 g	1	6713MH

6700SM-4, 6700SM-4.5, 6700SM-5, 6700SM-5.5, 6700SM-6, 6700SM-7, 6700SM-8, 6700SM-9, 6700SM-10, 6700SM-11, 6700SM-12, 6700SM-13, 6700SM-14

1/4" Square Drive Deep Socket Set on Rail with Metric Bi-Hex Profile



6708DMB

8	340 g	1	6708DMB

A6800DM-6, A6800DM-7, A6800DM-8, A6800DM-9, A6800DM-10, A6800DM-11, A6800DM-12, A6800DM-13

1/4" Square Drive Socket Set with Metric Bi-Hex Profile



6711MB

11	240 g	1	6711MB

A6700DM-5, A6700DM-5.5, A6700DM-6, A6700DM-7, A6700DM-8, A6700DM-9, A6700DM-10, A6700DM-11, A6700DM-12, A6700DM-13, A6700DM-14

1/4" Square Drive Socket Set with TORX® Head Screw



6706TE

6	150 g	1	6706TE

6700TORX-E4, 6700TORX-E5, 6700TORX-E6, 6700TORX-E7, 6700TORX-E8, 6700TORX-E10

1/4" Square Drive Socket Set with Metric Hex Profile and Refrigeration Ratchet



R6725MK

26 x 105 x 175 mm	1	R6725MK

6700SM-7, 6700SM-8, 6700SM-10

6954-5

R6967

R6810M-3.4, R6810M-4, R6810M-4.5, R6810M-5, R6810M-6, R6810M-7, R6810M-8, R6810M-9, R6810M-10

6966

R6950

6962, 6960-6

R6964A

1/4" Square Drive Socket Set with Imperial Hex Profile and Refrigeration Ratchet



R6725ZK

48 x 115 x 225 mm	1	R6725ZK

6700SZ-1/4, 6700SZ-5/16, 6700SZ-11/32, 6700SZ-3/8, 6700SZ-7/16, 6700SZ-1/2

6954-5

R6967

R6950

6962, 6960-6

R6810M-6

R6964A

6966

R6810Z-3/16, R6810Z-7/32, R6810Z-1/4, R6810Z-5/16, R6810Z-3/8

R6822Z

3/8" Square Drive Deep Socket Set



S1214L

49 x 152 x 280 mm	10	S1214L

1/4" and 3/8" Square Drive Socket Set with Metric Hex Profile and Ratchet



S330

70 x 160 x 280 mm	6	S330



1/4" and 3/8" Square Drive Deep Socket Set with Metric Hex Profile and Ratchet



S330L



100 x 215 x 375 mm



4 S330L

3/8" Square Drive Socket Set with Metric/Imperial Hex Profile



S380



100 x 215 x 375 mm



4 S380

3/8" Socket Set - 34 Pcs



SL34



70 x 160 x 280 mm



6 SL34

Pass-Through Socket Set with Flexi Head Ratchet/Extension Bars



S140T



65 x 160 x 280 mm



10 S140T

1 pc pass-through extension bar, 75 mm

SBS19-THR

SBS19-TH75

SBS19-TH10, SBS19-TH11, SBS19-TH12, SBS19-TH13, SBS19-TH14, SBS19-TH15, SBS19-TH16, SBS19-TH17, SBS19-TH18, SBS19-TH19, SBS19-TH21, SBS19-TH22, SBS19-TH24

SBS19-TH20

Pass-Through Ratchet Set with Hex to Square Drive Adaptors



S140T-R



121 x 280 x 220 mm



10 S140T-R

SBS19-THR

1RMA-19-3/8-SQ

1RMA-19-1/2-SQ

Pass-Through Socket Set with Flexi Head Ratchet/Adaptors



S530T



90 x 205 x 370 mm



4 S530T

1/4" and 3/8" Square Drive Socket Set with Imperial Hex Profile and Ratchet



S330AF



70 x 160 x 280 mm



6 S330AF

3/8" Square Drive Socket Set with Metric Bi-Hex Profile and Round Head Ratchet/Extension Bars



A7435DME



40 x 150 x 500 mm



1 A7435DME*

A7400DM-9, A7400DM-10, A7400DM-11, A7400DM-12, A7400DM-13, A7400DM-14, A7400DM-15, A7400DM-16, A7400DM-17, A7400DM-18, A7400DM-19, A7400DM-20, A7400DM-21, A7400DM-22

7755-3/8

7754, 7760, 7761

7762, 7760-3, 7760-5

7758

7752

7766

7760-10

3/8" Square Drive Socket Set with Metric Bi-Hex Profile and Round Head Ratchet



7422MBR

60 x 220 x 280 mm 1 7422MBR

A7400DM-6, A7400DM-7, A7400DM-8, A7400DM-9, A7400DM-10, A7400DM-11, A7400DM-12, A7400DM-13, A7400DM-14, A7400DM-15, A7400DM-16, A7400DM-17, A7400DM-18, A7400DM-19, A7400DM-20, A7400DM-21, A7400DM-22

- 7750RN
- 7760, 7754
- 7762, 7760-3
- 7766
- 7760-10

3/8" Square Drive Socket Set with Metric Hex Profile and Round Head Ratchet/T-Handle



7422MHR

50 x 160 x 350 mm 1 7422MHR

7400SM-6, 7400SM-7, 7400SM-8, 7400SM-9, 7400SM-10, 7400SM-11, 7400SM-12, 7400SM-13, 7400SM-14, 7400SM-15, 7400SM-16, 7400SM-17, 7400SM-18, 7400SM-19, 7400SM-20, 7400SM-21, 7400SM-22

- 7750RN
- 7760, 7754
- 7762, 7760-3
- 7766
- 7760-10

3/8" Square Drive Socket Set with Imperial Bi-Hex Profile and Round Head Ratchet/Breaker Bar



A7535DZE

165 x 500 x 45 mm 1 A7535DZE*

A7400DZ-1/2, A7400DZ-17/32, A7400DZ-1/4, A7400DZ-3/4, A7400DZ-13/16, A7400DZ-19/32, A7400DZ-11/16, A7400DZ-3/8, A7400DZ-7/16, A7400DZ-5/16, A7400DZ-7/8, A7400DZ-9/16, A7400DZ-5/8

- 7755-3/8
- 7754, 7760
- 7766
- 7758
- 7752
- 7762, 7760-3
- 7760-10

3/8" Square Drive Socket Set on Rail with Metric Hex Profile



7400SR/

12 35 x 220 x 25 mm 1 7400SR/S12

7400SM-11, 7400SM-10, 7400SM-15, 7400SM-14, 7400SM-13, 7400SM-12, 7400SM-16, 7400SM-9, 7400SM-8, 7400SM-17, 7400SM-19, 7400SM-18

3/8" Square Drive Socket Set on Rail with Metric Bi-Hex Profile



7409MB

9 370 g 1 7409MB

A7400DM-7, A7400DM-8, A7400DM-10, A7400DM-11, A7400DM-13, A7400DM-15, A7400DM-17, A7400DM-19, A7400DM-22

3/8" Square Drive Deep Socket Set on Rail with Metric Bi-Hex Profile



7408MD

8 690 g 1 7408MD

A7402DM-10, A7402DM-11, A7402DM-12, A7402DM-13, A7402DM-14, A7402DM-16, A7402DM-17, A7402DM-19

3/8" Square Drive Socket Set for TORX® Head Screw



7400TORX-ER/

7 25 x 55 x 190 mm 1 7400TORX-ER/S7

7400TORX-E14, 7400TORX-E12, 7400TORX-E11, 7400TORX-E10, 7400TORX-E18, 7400TORX-E16, 7400TORX-E8

* Until stocks last



1/2" Square Drive Deep Socket Set with Metric Hex Profile



S1612L



49 x 152 x 280 mm

4 S1612L

7805SM-10, 7805SM-11, 7805SM-12, 7805SM-13, 7805SM-14, 7805SM-15, 7805SM-16, 7805SM-17, 7805SM-18, 7805SM-19, 7805SM-20, 7805SM-21



1/2" socket set with Hex bits - 9 Pcs



S9HEX



46 x 130 x 195 mm

10 S9HEX

7809M-4, 7809M-5, 7809M-6, 7809M-7, 7809M-8, 7809M-10, 7809M-12, 7809M-14, 7809M-17



1/2" socket set with TORX® bits - 9 Pcs



S9TORX



46 x 130 x 195 mm

10 S9TORX

7809TORX-T20, 7809TORX-T25, 7809TORX-T27, 7809TORX-T30, 7809TORX-T40, 7809TORX-T45, 7809TORX-T50, 7809TORX-T55, 7809TORX-T60

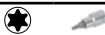

1/2" Socket Set with Hex Bits - 18 Pcs



S18HEX



100 x 210 x 370 mm

4 S18HEX

1/2" Socket Set with TORX® Bits - 18 Pcs



S18TORX



100 x 210 x 370 mm

4 S18TORX

1/2" Square Drive Socket Set with Metric Hex Profile and Ratchet



S240



100 x 215 x 375 mm

4 S240

8150QR

8166

8160-5, 8160-10

7772H

8158-10



7800SM-10, 7800SM-11, 7800SM-12, 7800SM-13, 7800SM-14, 7800SM-15, 7800SM-16, 7800SM-17, 7800SM-18, 7800SM-19, 7800SM-20, 7800SM-21, 7800SM-22, 7800SM-23, 7800SM-24, 7800SM-27, 7800SM-30, 7800SM-32



S240-BOX

1/2" Square Drive Socket Set with Metric Spline profile and Ratchet- 24 Pcs



S240-SPL



100 x 215 x 375 mm

4 S240-SPL

8150QR

8158-10

8166

7772H

8160-5, 8160-10

7800SPL-10, 7800SPL-11, 7800SPL-12, 7800SPL-13, 7800SPL-14, 7800SPL-15, 7800SPL-16, 7800SPL-17, 7800SPL-18, 7800SPL-19, 7800SPL-20, 7800SPL-21, 7800SPL-22, 7800SPL-23, 7800SPL-24, 7800SPL-27, 7800SPL-30, 7800SPL-32



1/2" Square Drive Socket Set with Metric Hex Profile and Combination Spanner Set



S400



110 x 320 x 375 mm

2 S400

8150QR

8158-10

8166

7772H

8160-5, 8160-10

7800SM-10, 7800SM-11, 7800SM-12, 7800SM-13, 7800SM-14, 7800SM-15, 7800SM-16, 7800SM-17, 7800SM-18, 7800SM-19, 7800SM-20, 7800SM-21, 7800SM-22, 7800SM-23, 7800SM-24, 7800SM-25, 7800SM-26, 7800SM-27, 7800SM-28, 7800SM-30, 7800SM-32



111M-7, 111M-8, 111M-9, 111M-10,
111M-11, 111M-12, 111M-13, 111M-14,
111M-15, 111M-16, 111M-17, 111M-18,
111M-19



1/2" Square Drive Socket Set with Imperial Hex Profile and Ratchet



S240AF



100 x 215 x 375 mm

4 S240AF

8150QR



8158-10



7805GPR-16, 7805GPR-21



8166



7772H



8160-5, 8160-10



7800SZ-3/8, 7800SZ-7/16, 7800SZ-1/2,
7800SZ-9/16, 7800SZ-5/8, 7800SZ-
11/16, 7800SZ-3/4, 7800SZ-13/16,
7800SZ-7/8, 7800SZ-15/16, 7800SZ-1,
7800SZ-1.1/16, 7800SZ-1.1/8, 7800SZ-
1.3/16, 7800SZ-1.1/4



1/2" Sockets inches and Combination
Spanners inches set - 35 Pcs



S350AF



110 x 371 x 313 mm

2 S350AF

1/2" Square Drive Socket Driver Set for
Metric Hex Head Screw



7809M/10



45 x 110 x 255 mm

1 7809M/10

7809M-5, 7809M-6, 7809M-7, 7809M-8,
7809M-9, 7809M-10, 7809M-12, 7809M-14,
7809M-17, 7809M-19



1/2" Square Drive Socket Driver Set for
Imperial Hex Head Screw



7809Z/10



45 x 110 x 255 mm

1 7809Z/10

7809Z-3/8, 7809Z-5/16, 7809Z-7/16,
7809Z-1/4, 7809Z-19/32, 7809Z-5/8,
7809Z-17/32, 7809Z-9/16, 7809Z-1/2,
7809Z-3/16



1/2" Square Drive Socket Driver Set for
TORX®/Phillips Head Screw



7809TORX/10



45 x 110 x 255 mm

1 7809TORX/10

7809TORX-T20, 7809TORX-T27,
7809TORX-T25, 7809TORX-T40,
7809TORX-T30, 7809TORX-T45,
7809TORX-T50, 7809TORX-T55



7809M-6, 7809M-8



1/4" and 1/2" Square Drive Socket Set with
Metric Bi-Hex Profile - 42 Pcs



7842MH



77 x 257 x 357 mm

1 7842MH

8150MH



8160-10



7772H



7800DM-10, 7800DM-11, 7800DM-12,
7800DM-13, 7800DM-15, 7800DM-17,
7800DM-19, 7800DM-22, 7800DM-24,
7800DM-27



6950MHS



6956MH



6973A



6960-6



A6700DM-5, A6700DM-5.5,
A6700DM-6, A6700DM-7, A6700DM-8,
A6700DM-9, A6700DM-10,
A6700DM-11, A6700DM-12,
A6700DM-13



59S/PZ1, 59S/PZ2



59S/PH1, 59S/PH2



59S/H4, 59S/H6, 59S/H8-3P, 59S/H10



59S/T10, 59S/T15, 59S/T20, 59S/T25,
59S/T30



59S/0.5-4.0, 59S/1.2-8.0



1/4" and 1/2" Square Drive Socket Set with Metric Bi-Hex Profile and Metal Handle Ratchet - 56 Pcs



S560MH

100 x 215 x 375 mm 4 S560MH

8150MH	
7800DM-10, 7800DM-11, 7800DM-12, 7800DM-13, 7800DM-14, 7800DM-15, 7800DM-17, 7800DM-19, 7800DM-22, 7800DM-24, 7800DM-27, 7800DM-30, 7800DM-32	
8160-5	
8166	
8174A	
7772H	
7805GPR-21	
8178	
6950MH	
6960,6962,6960-6	
6960-4	
6966	
6954-5	
6956MH	
6973A	
KM653-1P	
A6700DM-5, A6700DM-5.5, A6700DM-6, A6700DM-7, A6700DM-8, A6700DM-9, A6700DM-10, A6700DM-11, A6700DM-12, A6700DM-13	
A6800DM-4, A6800DM-5, A6800DM-6, A6800DM-7, A6800DM-8, A6800DM-9, A6800DM-10, A6800DM-11, A6800DM-12, A6800DM-13	
70S/T45, 70S/T50, 70S/T55	
1995M-1.5, 1995M-2, 1995M-2.5	

1/2" Square Drive Socket Set with Metric Bi-Hex Profile and Slim Head Ratchet Metal Case



7814DS

60 x 185 x 445 mm 1 7814DS

7800DM-10, 7800DM-11, 7800DM-12, 7800DM-13, 7800DM-14, 7800DM-15, 7800DM-16, 7800DM-17, 7800DM-18, 7800DM-19	
8150SL	
8160-5, 8160-10	
8166	

1/2" Square Drive Socket Set with Metric Bi-Hex Profile and Sliding T-Handle Metal Case



7818DS

60 x 185 x 445 mm 1 7818DS

7800DM-8, 7800DM-10, 7800DM-11, 7800DM-12, 7800DM-13, 7800DM-14, 7800DM-15, 7800DM-16, 7800DM-17, 7800DM-18, 7800DM-19, 7800DM-21, 7800DM-22	
8150SL	
8160-5, 8160-10	
8154-11	
8166	

1/2" Square Drive Socket Set with Metric Hex Profile and Round Head Ratchet



7818MHR

50 x 185 x 445 mm 1 7818MHR

7800SM-10, 7800SM-11, 7800SM-12, 7800SM-13, 7800SM-14, 7800SM-15, 7800SM-17, 7800SM-19, 7800SM-22, 7800SM-24, 7800SM-27, 7800SM-30, 7800SM-32	
8150RN-1/2	
8160-5, 8160-10	
8154-11	
8166	

1/2" Square Drive Socket Set with Metric Hex Profile and Reversible Ratchet/Sliding T-Handle



7825MHP

60 x 185 x 445 mm 1 7825MHP

7800SM-10, 7800SM-11, 7800SM-12, 7800SM-13, 7800SM-14, 7800SM-15, 7800SM-16, 7800SM-17, 7800SM-18, 7800SM-19, 7800SM-20, 7800SM-21, 7800SM-22, 7800SM-23, 7800SM-24, 7800SM-26, 7800SM-27, 7800SM-28, 7800SM-30, 7800SM-32	
8150-1/2	
8160-5, 8160-10	
8154-11	
8166	
4750BMC10	

1/2" Square Drive Socket Set with Metric Bi-Hex Profile and Reversible Ratchet/Universal Joint



7825MBP

60 x 185 x 445 mm 1 7825MBP

7800DM-10, 7800DM-11, 7800DM-12, 7800DM-13, 7800DM-14, 7800DM-15, 7800DM-16, 7800DM-17, 7800DM-18, 7800DM-19, 7800DM-20, 7800DM-21, 7800DM-22, 7800DM-23, 7800DM-24, 7800DM-26, 7800DM-27, 7800DM-28, 7800DM-30, 7800DM-32	
8150-1/2	
8160-5, 8160-10	
8154-11	
8166	

1/2" Square Drive Socket Set with Metric Bi-Hex Profile and Round Head Ratchet



7819DRN

51 x 225 x 445 mm 1 7819DRN

7800DM-19, 7800DM-18, 7800DM-17, 7800DM-16, 7800DM-23, 7800DM-22, 7800DM-21, 7800DM-11, 7800DM-10, 7800DM-15, 7800DM-13, 7800DM-14, 7800DM-12, 7800DM-24, 7800DM-26, 7800DM-27, 7800DM-28, 7800DM-30, 7800DM-32		
8150RN-1/2		
8152-1/2		
8166		
8160-5, 8160-10		
8154-11		
8166		
4750BMC10		

1/2" Square Drive Socket Set with Metric Bi-Hex Profile and Pear Head Ratchet/ Extension Bars



7888DM

73 x 340 x 445 mm 1 7888DM

7800DM-10, 7800DM-11, 7800DM-12, 7800DM-13, 7800DM-14, 7800DM-15, 7800DM-16, 7800DM-17, 7800DM-18, 7800DM-19, 7800DM-20, 7800DM-21, 7800DM-22, 7800DM-23, 7800DM-24, 7800DM-26, 7800DM-27, 7800DM-28, 7800DM-30, 7800DM-32		
8150-1/2		
8154-11		
8160-3, 8160-5, 8160-10		
8166		
8157-15		

1/4" and 1/2" Square Drive Socket Set with Metric Hex Profile



7847SS

60 x 225 x 445 mm 1 7847SS

6700SM-5, 6700SM-6, 6700SM-7, 6700SM-8, 6700SM-9, 6700SM-10, 6700SM-11, 6700SM-12, 6700SM-13		
6950SL		
6960, 6962, 6960-6		
6954-5		
6966		
6956		
59S/PH1, 59S/PH2, 59S/PH3		
59S/PZ1, 59S/PZ2, 59S/PZ3		
59S/0.6-4.5, 59S/0.8-5.5, 59S/1.2-8.0		
59S/H3, 59S/H4, 59S/H5, 59S/H6		
7800SM-10, 7800SM-11, 7800SM-12, 7800SM-13, 7800SM-14, 7800SM-15, 7800SM-17, 7800SM-19, 7800SM-22, 7800SM-24, 7800SM-27, 7800SM-30, 7800SM-32		
8150SL		
6973A		
8160-5, 8160-10		
8154-11		
8166		

1/2" Square Drive Socket Set with Imperial Bi-Hex Profile and Slim Head Ratchet



7817DZS

60 x 185 x 445 mm 1 7817DZS

--	--	--

7800DZ-3/8, 7800DZ-7/16, 7800DZ-1/2, 7800DZ-9/16, 7800DZ-5/8, 7800DZ-11/16, 7800DZ-3/4, 7800DZ-13/16, 7800DZ-7/8, 7800DZ-15/16, 7800DZ-1, 7800DZ-1.1/8, 7800DZ-1.1/4		
8150SL		
8160-5, 8160-10		
8166		

1/2" Square Drive Socket Set with Imperial Bi-Hex Profile and Slim Head Ratchet - 13 Pcs



7817DZS1

60 x 185 x 445 mm 1 7817DZS1

--	--	--

7800DZ-3/8, 7800DZ-7/16, 7800DZ-1/2, 7800DZ-9/16, 7800DZ-5/8, 7800DZ-11/16, 7800DZ-3/4, 7800DZ-13/16, 7800DZ-7/8, 7800DZ-15/16, 7800DZ-1, 7800DZ-1.1/8, 7800DZ-1.1/16		
8150SL		
8160-5, 8160-10		
8166		

1/2" Square Drive Socket Set with Imperial Bi-Hex Profile and Slim Head Ratchet/ Sliding T-Handle



7823DZS

60 x 185 x 445 mm 1 7823DZS

--	--	--

7800DZ-3/8, 7800DZ-7/16, 7800DZ-1/2, 7800DZ-9/16, 7800DZ-19/32, 7800DZ-5/8, 7800DZ-11/16, 7800DZ-3/4, 7800DZ-25/32, 7800DZ-13/16, 7800DZ-7/8, 7800DZ-15/16, 7800DZ-1, 7800DZ-1.1/16, 7800DZ-1.1/8, 7800DZ-1.3/16, 7800DZ-1.1/4, 7800DZ-1.5/16		
8150SL		
8160-5, 8160-10		
8154-11		
8166		



1/2" Square Drive Socket Set with Metric Bi-Hex Profile and Slim Head Ratchet Polyester Textile Case



7814DST



60 x 220 x 480 mm

1 7814DST*

7800DM-10, 7800DM-11, 7800DM-12, 7800DM-13, 7800DM-14, 7800DM-15, 7800DM-16, 7800DM-17, 7800DM-18, 7800DM-19



8150SL



8160-5, 8160-10



8166



1/2" Square Drive Socket Set with Metric Bi-Hex Profile and Sliding T-Handle Polyester Textile Case



7818DST



60 x 220 x 480 mm

1 7818DST

7800DM-8, 7800DM-10, 7800DM-11, 7800DM-12, 7800DM-13, 7800DM-14, 7800DM-15, 7800DM-16, 7800DM-17, 7800DM-18, 7800DM-19, 7800DM-21, 7800DM-22



8150SL



8160-5, 8160-10



8166



8154-11



1/2" Square Drive Socket Set with Metric Hex Profile and Slim Head Ratchet/ Universal Joint



7825SST



65 x 250 x 480 mm

1 7825SST

7800SM-10, 7800SM-11, 7800SM-12, 7800SM-13, 7800SM-14, 7800SM-15, 7800SM-16, 7800SM-17, 7800SM-18, 7800SM-19, 7800SM-20, 7800SM-21, 7800SM-22, 7800SM-23, 7800SM-24, 7800SM-26, 7800SM-27, 7800SM-28, 7800SM-30, 7800SM-32



8150SL



8160-1/2, 8162-1/2, 8166-1/2, 8154-1/2



8160-5, 8160-10



8166



8154-11



1/2" Square Drive Socket Set with Metric Bi-Hex Profile and Slim Head Ratchet



7825DST



65 x 250 x 480 mm

1 7825DST*

7800DM-10, 7800DM-11, 7800DM-12, 7800DM-13, 7800DM-14, 7800DM-15, 7800DM-16, 7800DM-17, 7800DM-18, 7800DM-19, 7800DM-20, 7800DM-21, 7800DM-22, 7800DM-23, 7800DM-24, 7800DM-26, 7800DM-27, 7800DM-28



8150SL



8160-1/2, 8162-1/2, 8166-1/2, 8154-1/2



8160-5, 8160-10



8166



8154-11



1/2" Square Drive Socket Set on Rail with Metric Hex Profile



7810MH

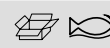

10

810 g

1 7810MH

7800SM-10, 7800SM-11, 7800SM-13, 7800SM-14, 7800SM-15, 7800SM-16, 7800SM-19, 7800SM-17, 7800SM-21, 7800SM-22



1/2" Square Drive Socket Set with Metric Bi-Hex Profile - 10 Pcs/Rail



7810MB



10

1 7810MB

7800DM-11, 7800DM-10, 7800DM-14,
7800DM-13, 7800DM-16, 7800DM-17,
7800DM-19, 7800DM-22, 7800DM-21,
7800DM-15



1/2" Square Drive Socket Set with Metric
Bi-Hex Profile - 6 Pcs/Rail



7806MD



			
6	950 g	1	7806MD

7805DM-10, 7805DM-14, 7805DM-13,
7805DM-17, 7805DM-19, 7805DM-22



1/2" Square Drive Socket Set on Rail with
TORX® Profile



7807TE



			
7	600 g	1	7807TE

7800TORX-E10, 7800TORX-E12,
7800TORX-E14, 7800TORX-E16,
7800TORX-E18, 7800TORX-E20,
7800TORX-E24



3/4" Square Drive Socket Set with Metric
Hex Profile and Ratchet Head - 17 Pcs/
Case



SLX 17

	
375 x 430 x 110 mm	1 SLX 17

3/4" Square Drive Socket Set with Imperial
Hex Profile and Ratchet Head - 17 Pcs





SLX17AF

	
70 x 375 x 430 mm	1 SLX 17AF

3/4" Square Drive Socket Set with Metric
Hex Profile and Ratchet Head - 20 Pcs/
Case



SLX20

	
375 x 430 x 110 mm	2 SLX20

3/4" Square Drive Socket Set with Metric
Hex Profile and Round Ratchet Head/
Sliding T-Head









8845NM

	
94 x 206 x 591 mm	1 8845NM

8900SM-19, 8900SM-22, 8900SM-24,
8900SM-27, 8900SM-30, 8900SM-32,
8900SM-33, 8900SM-34, 8900SM-36,
8900SM-38, 8900SM-41, 8900SM-46,
8900SM-50



8960-8, 8960-16	
8954A	
8950RN/A	
8953-16	
8966	
8957A	

8900SM-24, 8900SM-22, 8900SM-27,
8900SM-30, 8900SM-32, 8900SM-36,
8900SM-38, 8900SM-41, 8900SM-46,
8900SM-50



8953	
8954A	
8962, 8961	
8950N/A, 8950RN/A	
8955N/B	
8960-16, 8960-8	

* Until stocks last



3/4" Square Drive Socket Set with Metric Bi-Hex Profile and Round Ratchet Head/ Sliding T-Head



8845DM



94 x 206 x 591 mm



1 8845DM

8900DM-19, 8900DM-22, 8900DM-24, 8900DM-25, 8900DM-27, 8900DM-28, 8900DM-30, 8900DM-32, 8900DM-36, 8900DM-41, 8900DM-46, 8900DM-50



8950N/A, 8950RN/A

8953

8954A

8961, 8962

8955N/B

8960-8, 8960-16

3/4" Square Drive Socket Set with Metric Bi-Hex Profile - 24 Pcs



8840M



100 x 210 x 595 mm



1 8840M

8900DM-19, 8900DM-22, 8900DM-24, 8900DM-25, 8900DM-27, 8900DM-28, 8900DM-30, 8900DM-32, 8900DM-36, 8900DM-41, 8900DM-46, 8900DM-50, 8900DM-55, 8900DM-60

8953

8950N/A, 8950RN/A

8951

8954A

8958A

8962, 8961

8966

8965, 8971

8172

8955N/B

8957A

8960-16, 8960-8

3/4" Square Drive Socket Set with Metric Bi-Hex Profile and Round Ratchet Head



8821MB



95 x 220 x 600 mm



1 8821MB

8950N/A, 8950RN/A

8954, 8954-15

8965, 8971

8966

8961, 8962

8900DM-26, 8900DM-23, 8900DM-22, 8900DM-24, 8900DM-27, 8900DM-29, 8900DM-28, 8900DM-32, 8900DM-30, 8900DM-34, 8900DM-38, 8900DM-35, 8900DM-36, 8900DM-46, 8900DM-41, 8900DM-42, 8900DM-50

8960-8, 8960-16

1" Square Drive Socket Set with Metric Hex Profile and Round Head Ratchet



9540MB



210 x 560 x 120 mm



1 9540MB

9500SM-80, 9500SM-75, 9500SM-70, 9500SM-65, 9500SM-60, 9500SM-55, 9500SM-50, 9500SM-46

9550AB

9555

9560AB, 9563AB

1" Square Drive Socket Set with Metric Hex Profile and Round Head Ratchet/ Adaptor



9540MBL



225 x 605 x 120 mm



1 9540MBL

9500SM-80, 9500SM-77, 9500SM-71, 9500SM-70, 9500SM-67, 9500SM-65, 9500SM-63, 9500SM-60, 9500SM-75, 9500SM-46, 9500SM-50, 9500SM-54, 9500SM-55, 9500SM-58

9550AB

9560AB, 9563AB

9555

1" Socket Set with Imperial Bi-Hex Profile - 11 Pcs



9540DZ



150 x 260 x 670 mm



1 9540DZ

9550AB

9555

9563AB, 9560AB

9500DZ-2.3/4, 9500DZ-2.3/8, 9500DZ-2.3/16, 9500DZ-3, 9500DZ-1.13/16, 9500DZ-3.1/8, 9500DZ-2.5/8, 9500DZ-2

1" Socket Set bihexagonal in inches. Metal case



9540DZL

140 x 285 x 630 mm	1	9540DZL
--------------------	---	---------

9500DZ-2.1/4, 9500DZ-2.3/4, 9500DZ-2.3/8, 9500DZ-2.1/2, 9500DZ-2.15/16, 9500DZ-2.1/8, 9500DZ-1.7/8, 9500DZ-2.3/16, 9500DZ-3, 9500DZ-1.13/16, 9500DZ-3.1/8, 9500DZ-2.5/8, 9500DZ-2, 9500DZ-2.9/16		
--	--	--

9550AB		
9555		
9563AB, 9560AB		
9565AB		

1/4"

1/4" Square Drive Sockets with Metric Hex Profile and High Polished Finish



6700SM

4 mm	5	6700SM-4
4.5 mm	5	6700SM-4.5
5 mm	5	6700SM-5
5.5 mm	5	6700SM-5.5
6 mm	5	6700SM-6
7 mm	5	6700SM-7
8 mm	5	6700SM-8
9 mm	5	6700SM-9
10 mm	5	6700SM-10
11 mm	5	6700SM-11
12 mm	5	6700SM-12
13 mm	5	6700SM-13
14 mm	5	6700SM-14

4 mm	1	SB6700SM-4
4.5 mm	1	SB6700SM-4.5
5 mm	1	SB6700SM-5
5.5 mm	1	SB6700SM-5.5
6 mm	1	SB6700SM-6
7 mm	1	SB6700SM-7
8 mm	1	SB6700SM-8
9 mm	1	SB6700SM-9

10 mm	1	SB6700SM-10
11 mm	1	SB6700SM-11
12 mm	1	SB6700SM-12
13 mm	1	SB6700SM-13
14 mm	1	SB6700SM-14

SB: Retail pack on a plastic info card

1/4" Square Drive Sockets with Imperial Hex Profile



6700SZ

1/8 in	5	6700SZ-1/8
5/32 in	5	6700SZ-5/32
3/16 in	5	6700SZ-3/16
7/32 in	5	6700SZ-7/32
1/4 in	5	6700SZ-1/4
9/32 in	5	6700SZ-9/32
5/16 in	5	6700SZ-5/16
11/32 in	5	6700SZ-11/32
3/8 in	5	6700SZ-3/8
7/16 in	5	6700SZ-7/16
1/2 in	5	6700SZ-1/2
9/16 in	5	6700SZ-9/16
1/8 in	5	SB6700SZ-1/8
5/32 in	1	SB6700SZ-5/32
3/16 in	1	SB6700SZ-3/16
7/32 in	1	SB6700SZ-7/32
1/4 in	1	SB6700SZ-1/4
5/16 in	1	SB6700SZ-5/16
11/32 in	1	SB6700SZ-11/32
3/8 in	1	SB6700SZ-3/8
7/16 in	1	SB6700SZ-7/16
1/2 in	1	SB6700SZ-1/2
9/16 in	1	SB6700SZ-9/16

SB: Retail pack on a plastic info card

1/4" Square Drive Sockets with TORX® Profile



6700TORX-E

E4	5	6700TORX-E4
E5	5	6700TORX-E5
E6	5	6700TORX-E6

E7	5	6700TORX-E7
E8	5	6700TORX-E8
E10	5	6700TORX-E10
E4	1	SB6700TORX-E4
E5	1	SB6700TORX-E5
E6	1	SB6700TORX-E6
E7	1	SB6700TORX-E7
E8	1	SB6700TORX-E8

SB: Retail pack on a plastic info card

1/4" Square Drive Sockets with Metric Square Profile for Refrigeration Ratchet



R6810M

3.4 mm	5	R6810M-3,4
4 mm	5	R6810M-4
4.5 mm	5	R6810M-4,5
5 mm	5	R6810M-5
6 mm	5	R6810M-6
7 mm	1	R6810M-7
8 mm	5	R6810M-8
9 mm	5	R6810M-9
10 mm	5	R6810M-10

1/4" Square Drive Sockets with Imperial Square Profile for Refrigeration Ratchet



R6810Z

3/16 in	1	R6810Z-3/16
7/32 in	1	R6810Z-7/32
1/4 in	1	R6810Z-1/4
5/16 in	1	R6810Z-5/16
3/8 in	1	R6810Z-3/8



1/4" Square Drive Plumbing Adaptor for Refrigeration Ratchet



R6822Z



5 R6822Z

1/4" Square Drive Female to Female Adaptor



R6967



1/4

5 R6967

1/4" Square Drive Male to Male Adaptor



R6964A



1 R6964A

1/4" Square Drive Sockets with Metric Bi-Hex Profile



A6700DM



4 mm	5	A6700DM-4
4.5 mm	5	A6700DM-4.5
5 mm	5	A6700DM-5
5.5 mm	5	A6700DM-5.5
6 mm	5	A6700DM-6
7 mm	5	A6700DM-7
8 mm	5	A6700DM-8
9 mm	5	A6700DM-9
10 mm	5	A6700DM-10
11 mm	5	A6700DM-11
12 mm	5	A6700DM-12
13 mm	5	A6700DM-13
14 mm	5	A6700DM-14
5 mm	1	SBA6700DM-5
5.5 mm	1	SBA6700DM-5.5
6 mm	1	SBA6700DM-6
7 mm	1	SBA6700DM-7
8 mm	1	SBA6700DM-8
9 mm	1	SBA6700DM-9
10 mm	1	SBA6700DM-10
11 mm	1	SBA6700DM-11
12 mm	1	SBA6700DM-12
13 mm	1	SBA6700DM-13
14 mm	1	SBA6700DM-14

SB: Retail pack on a plastic info card

1/4" Square Drive Sockets with Imperial Bi-Hex Profile



A6700DZ



3/16 in	5	A6700DZ-3/16
7/32 in	5	A6700DZ-7/32
1/4 in	5	A6700DZ-1/4
9/32 in	5	A6700DZ-9/32
5/16 in	5	A6700DZ-5/16
11/32 in	5	A6700DZ-11/32
3/8 in	5	A6700DZ-3/8
7/16 in	5	A6700DZ-7/16
1/2 in	5	A6700DZ-1/2
9/16 in	5	A6700DZ-9/16

SB: Retail pack on a plastic info card

1/4" Square Drive Deep Sockets with Metric Bi-Hex Profile



A6800DM



4 mm	1	A6800DM-4
5 mm	1	A6800DM-5
5.5 mm	1	A6800DM-5.5
6 mm	1	A6800DM-6
7 mm	1	A6800DM-7
8 mm	1	A6800DM-8
9 mm	1	A6800DM-9
10 mm	1	A6800DM-10
11 mm	1	A6800DM-11
12 mm	1	A6800DM-12
13 mm	1	A6800DM-13
14 mm	1	A6800DM-14
4 mm	1	SBA6800DM-4
5 mm	1	SBA6800DM-5
5.5 mm	1	SBA6800DM-5.5
6 mm	1	SBA6800DM-6
7 mm	1	SBA6800DM-7
8 mm	1	SBA6800DM-8
9 mm	1	SBA6800DM-9
10 mm	1	SBA6800DM-10
11 mm	1	SBA6800DM-11
12 mm	1	SBA6800DM-12
13 mm	1	SBA6800DM-13
14 mm	1	SBA6800DM-14

SB: Retail pack on a plastic info card

1/4" Square Drive Deep Sockets with Metric Hex Profile



A6800SM



4 mm	1	A6800SM-4
4.5 mm	1	A6800SM-4.5
5 mm	1	A6800SM-5
6 mm	1	A6800SM-6
7 mm	1	A6800SM-7
8 mm	1	A6800SM-8
9 mm	1	A6800SM-9
10 mm	1	A6800SM-10
11 mm	1	A6800SM-11
12 mm	1	A6800SM-12
13 mm	1	A6800SM-13
14 mm	1	A6800SM-14
15 mm	1	A6800SM-15

SB: Retail pack on a plastic info card

1/4" Square Drive Deep Sockets with Imperial Hex Profile



A6800SZ



1/8 in	1	A6800SZ-1/8*
5/32 in	1	A6800SZ-5/32*

1/4" Square Drive Deep Sockets with Imperial Bi-Hex Profile



A6800DZ



3/16 in	1	A6800DZ-3/16
7/32 in	1	A6800DZ-7/32
1/4 in	1	A6800DZ-1/4
9/32 in	1	A6800DZ-9/32
5/16 in	1	A6800DZ-5/16
11/32 in	1	A6800DZ-11/32
3/8 in	1	A6800DZ-3/8
7/16 in	1	A6800DZ-7/16
1/2 in	1	A6800DZ-1/2
9/16 in	1	A6800DZ-9/16
3/16 in	1	SBA6800DZ-3/16
7/32 in	1	SBA6800DZ-7/32
1/4 in	1	SBA6800DZ-1/4
9/32 in	1	SBA6800DZ-9/32
5/16 in	1	SBA6800DZ-5/16
11/32 in	1	SBA6800DZ-11/32
3/8 in	1	SBA6800DZ-3/8
7/16 in	1	SBA6800DZ-7/16
1/2 in	1	SBA6800DZ-1/2
9/16 in	1	SBA6800DZ-9/16

SB: Retail pack on a plastic info card

1/4" Square Drive Swivel Sockets with Metric Bi-Hex Profile



A6710DM



5.5 mm	1	A6710DM-5.5
6 mm	1	A6710DM-6
7 mm	1	A6710DM-7
8 mm	1	A6710DM-8
9 mm	1	A6710DM-9
10 mm	1	A6710DM-10
11 mm	1	A6710DM-11
12 mm	1	A6710DM-12
13 mm	1	A6710DM-13
14 mm	1	A6710DM-14

1/4" Square Drive Swivel Sockets with Imperial Bi-Hex Profile



A6710DZ



3/16 in	1	A6710DZ-3/16
7/32 in	1	A6710DZ-7/32
1/4 in	1	A6710DZ-1/4
9/32 in	1	A6710DZ-9/32
5/16 in	1	A6710DZ-5/16
11/32 in	1	A6710DZ-11/32
3/8 in	1	A6710DZ-3/8
7/16 in	1	A6710DZ-7/16
1/2 in	1	A6710DZ-1/2
9/16 in	1	A6710DZ-9/16

1/4" Square Drive Breaker Bars with Swivel Head



6958



153 mm	1	6958-6
153 mm	1	SB6958-6

SB: Retail pack on a plastic info card

1/4" Square Drive Breaker Bar with Swivel Head and metal handle



6957-6



150 mm	10	6957-6
--------	----	--------

1/4" Square Drive Sliding T-Handles



6954



125 mm	10	6954-5
125 mm	1	SB6954-5

SB: Retail pack on a plastic info card

1/4" Square Drive Spinner Handles



6956



150 mm	10	6956
150 mm	1	SB6956

SB: Retail pack on a plastic info card

1/4" square drive Spinner metal handle



6956MH



150 mm	10	6956MH
--------	----	--------



1/4" Square Drive Extension Bars



6960 - 6962L

Length	Quantity	Part Number
26 mm	1	696EX-01
75 mm	10	6960-3
150 mm	10	6960-6
152 mm	1	696EX-06*
276 mm	1	696EX-11
355 mm	1	6960-14
75 mm	1	SB6960-3
101 mm	1	SB6961*
150	1	SB6960-6
355 mm	1	SB6960-14

SB: Retail pack

1/4" Square Drive Universal Joints



6966

Length	Quantity	Part Number
35 mm	10	6966
35 mm	1	SB6966

SB: Retail pack on a plastic info card

1/4" Square Drive Adaptors for Hex Screwdriver Bit



6972H

Hex Size	Quantity	Part Number
1/4" in	1	6972H

1/4" Square Drive Wobbler Extension Bars



6960-W - 6962-W

Length	Quantity	Part Number
50 mm	10	6960W-2
100 mm	1	6960W-4
150 mm	10	6960W-6

1/4" Square Drive Universal Joints for Smooth Operations



6968

Length	Quantity	Part Number
35 mm	100	6968

1/4" Square Drive Magnetic Adaptors for 1/4" Hex Screwdriver Bit



6973M

Hex Size	Quantity	Part Number
1/4" in	1	6973M

1/4" Square Drive Flexible Extension Bars



6960F

Length	Quantity	Part Number
150 mm	1	SB6960F-6
150 mm	20	6960F-6

SB: Retail pack

1/4" Square Drive to 1/4" Hex Bit Adaptors



6709HL

Hex Size	Quantity	Part Number
1/4 in	100	6709HL

1/4" Square Drive Adaptors for 1/4" Hex Screwdriver Bit



6973A

Hex Size	Quantity	Part Number
1/4 in	10	6973A
1/4 in	1	SB6973A

SB: retail packed on a plastic info card

1/4" Square Drive to 1/4" Socket Flat Adaptors



6969



1/4	1	6969
-----	---	------

Socket Rails for 1/4" 3/8" and 1/2" Clips



RAIL-187/264/340



203 mm	10	RAIL-8
250 mm	10	RAIL-10
340 mm	3	RAIL-340*

1/4" Square Drive Socket Drivers for Philips Head Screw



6709PH



1	5	6709PH-1
2	5	6709PH-2
3	5	6709PH-3
4	5	6709PH-4
1	1	SB6709PH-1
2	1	SB6709PH-2
3	1	SB6709PH-3

SB: Retail pack on a plastic info card

1/4" Square Drive to 3/8" Socket Increasing Flat Adaptors



7767



1/4	1	7767
1/4	1	SB7767

SB: Retail pack on a plastic info card

Rail-Clips for 1/4" Sockets/Socket Drivers



C1/4



17 mm	25	CLIPS-1/4
-------	----	-----------

1/4" Square Drive Socket Drivers for Pozidriv Head Screw



6709PZ



1	5	6709PZ-1
2	5	6709PZ-2
3	5	6709PZ-3
1	1	SB6709PZ-1
2	1	SB6709PZ-2
3	1	SB6709PZ-3

SB: Retail pack on a plastic info card

1/4" Square Drive Increasing Flat Adaptor Set



8967/S3



110 x 194 x 30 mm	1	8967/S3
-------------------	---	---------

7767

8167

8967

1/4" Square Drive Socket Drivers for Slotted Head Screw



6709F



0.6 mm	4.5 mm	5	6709F-4.5
0.8 mm	5.5 mm	5	6709F-5.5
0.9 mm	6.5 mm	5	6709F-6.5
1.2 mm	8 mm	5	6709F-8
0.8 mm	5.5 mm	1	SB6709F-5.5
1.2 mm	8 mm	1	SB6709F-8

SB: Retail pack on a plastic info card

* Until stocks last



1/4" Square Drive Socket Drivers for TORX® Head Screw



6709TORX



T6	5	6709TORX-T6
T7	5	6709TORX-T7
T8	5	6709TORX-T8
T9	5	6709TORX-T9
T10	5	6709TORX-T10
T15	5	6709TORX-T15
T20	5	6709TORX-T20
T25	5	6709TORX-T25
T27	5	6709TORX-T27
T30	5	6709TORX-T30
T40	5	6709TORX-T40
<hr/>		
T8	1	SB6709TORX-T8
T9	1	SB6709TORX-T9
T10	1	SB6709TORX-T10
T15	1	SB6709TORX-T15
T20	1	SB6709TORX-T20
T25	1	SB6709TORX-T25
T27	1	SB6709TORX-T27
T30	1	SB6709TORX-T30
T40	1	SB6709TORX-T40

SB: Retail pack on a plastic info card

1/4" Square Drive Socket Drivers for TORX® Tamper-Resistant Head Screw



6709TORX-R



TR 8	1	6709TORX-R-T8
TR 10	1	6709TORX-R-T10
TR 15	1	6709TORX-R-T15
TR 20	1	6709TORX-R-T20
TR 25	1	6709TORX-R-T25
<hr/>		
TR 8	1	SB6709TORX-R-T8*
TR 10	1	SB6709TORX-R-T10*
TR 15	1	SB6709TORX-R-T15*
TR 20	1	SB6709TORX-R-T20*
TR 25	1	SB6709TORX-R-T25*

SB: Retail pack on a plastic info card

1/4" Square Drive Socket Drivers for TORX® PLUS® Head Screw



6709-IP



IP6		1	6709-IP6
IP7		1	6709-IP7
IP8		1	6709-IP8
IP9		1	6709-IP9
IP10	M3	1	6709-IP10
IP15	-	1	6709-IP15
IP20	M4	1	6709-IP20
IP25	M5	1	6709-IP25
IP27	-	1	6709-IP27
IP30	M6	1	6709-IP30
IP40	M8	1	6709-IP40
IP45	-	1	6709-IP45

SB: Retail pack

1/4" Square Drive Socket Drivers for Hex Head Screw



6709M



3 mm	5	6709M-3
4 mm	5	6709M-4
5 mm	5	6709M-5
6 mm	5	6709M-6
8 mm	5	6709M-8
10 mm	5	6709M-10
<hr/>		
4 mm	1	SB6709M-4
5 mm	1	SB6709M-5
6 mm	1	SB6709M-6
8 mm	1	SB6709M-8

SB: Retail pack on a plastic info card

1/4" Square Drive Deep Socket Drivers for Metric Hex Head Screw



A6709M



2.5 mm	1	A6709M-2.5
3 mm	1	A6709M-3
4 mm	1	A6709M-4
5 mm	1	A6709M-5
6 mm	1	A6709M-6
<hr/>		
2.5 mm	1	SBA6709M-2.5
3 mm	1	SBA6709M-3
4 mm	1	SBA6709M-4
5 mm	1	SBA6709M-5
6 mm	1	SBA6709M-6

SB: Retail pack on a plastic info card

1/4" Square Drive Deep Socket Drivers for Imperial Hex Head Screw



A6709Z



1/8 in	1	A6709Z-1/8
9/64 in	1	A6709Z-9/64
5/32 in	1	A6709Z-5/32
3/16 in	1	A6709Z-3/16
<hr/>		
1/8 in	1	SBA6709Z-1/8
9/64 in	1	SBA6709Z-9/64
5/32 in	1	SBA6709Z-5/32
3/16 in	1	SBA6709Z-3/16

SB: Retail pack on a plastic info card

1/4" Slim Head Reversible Ratchets with 72 Teeth and 5° Action Angle



6950SL

119 mm	72	1	6950SL

1/4" Refrigeration Reversible Ratchets with 32 Teeth and 11.5° Action Angle



R6950

160 mm	32	1	R6950

1/4" Pear Head Reversible Ratchets with 60 Teeth and 6° Action Angle



6950QR

145 mm	60	10	6950QR
145 mm	60	1	SB6950QR

SB: Retail pack

1/4" Pear Head Reversible Ratchets with 72 Teeth and 5° Action Angle



6950

121 mm	72	1	6950
121 mm	72	1	SB6950

SB: Retail pack

1/4" Pear Head Reversible Ratchet with 60 Teeth Metal Handle



6950MH

150 mm	60	10	6950MH
150 mm	60	1	SB6950MH

SB: Retail pack

1/4" Pear Head Short Reversible Ratchets with 60 Teeth and 6° Action Angle



6950QRS

120 m	60	10	6950QRS
120 m	60	1	SB6950QRS

SB: Retail pack

1/4" Round Head Reversible Ratchets with 72 Teeth and 5° Action Angle



6950RN

121 mm	72	1	6950RN
121 mm	72	1	SB6950RN

SB: Retail pack

1/4" Pear Head Short Reversible Ratchet with 60 Teeth and Metal Handle



6950MHS

120 mm	60	10	6950MHS
120	60	1	SB6950MHS

SB: Retail pack

1/4" Swivel Head Ratchets with 72 Teeth and 5° Action Angle



8120-1/4

149 mm	72	20	8120-1/4

* Until stocks last



Combination Ratcheting Wrenches for Screwdriver Bits



6950CBR

52	10	6950CBR
52	1	SB6950CBR

SB: Retail pack

Ratcheting Adaptors with 52 Teeth for 1/4" Ratchet



6951

40 mm	1	6951

Spare Part Kit for 6950SL 1/4" Ratchet



6950SL-SPARE

10	6950SL	1 6950SL-SPARE

1/4" Spare Part Kit for 6950 Ratchet



6950-SPARE

12	6950	1	6950-SPARE

Spare Part Kit for 6950RN 1/4" Ratchet



6950RN-SPARE

6	6950RN	1	6950RN-SPARE

3/8"

3/8" Square Drive Sockets with Metric Hex Profile and High Polished Finish



7400SM

6 mm	5	7400SM-6
7 mm	5	7400SM-7
8 mm	5	7400SM-8
9 mm	5	7400SM-9
10 mm	5	7400SM-10
11 mm	5	7400SM-11

12 mm	5	7400SM-12
13 mm	5	7400SM-13
14 mm	5	7400SM-14
15 mm	5	7400SM-15
16 mm	5	7400SM-16
17 mm	5	7400SM-17
18 mm	5	7400SM-18
19 mm	5	7400SM-19
20 mm	5	7400SM-20
21 mm	5	7400SM-21
22 mm	5	7400SM-22
6 mm	1	SB7400SM-6
7 mm	1	SB7400SM-7
8 mm	1	SB7400SM-8
9 mm	1	SB7400SM-9
10 mm	1	SB7400SM-10
11 mm	1	SB7400SM-11
12 mm	1	SB7400SM-12
13 mm	1	SB7400SM-13
14 mm	1	SB7400SM-14
15 mm	1	SB7400SM-15
16 mm	1	SB7400SM-16
17 mm	1	SB7400SM-17
18 mm	1	SB7400SM-18
19 mm	1	SB7400SM-19
20 mm	1	SB7400SM-20
21 mm	1	SB7400SM-21
22 mm	1	SB7400SM-22



SB: Retail pack on a plastic info card

3/8" Square Drive Sockets with Metric Bi-Hex Profile



A7400DM

6 mm	5	A7400DM-6
7 mm	5	A7400DM-7
8 mm	5	A7400DM-8
9 mm	5	A7400DM-9
10 mm	5	A7400DM-10
11 mm	5	A7400DM-11
12 mm	5	A7400DM-12
13 mm	5	A7400DM-13
14 mm	5	A7400DM-14
15 mm	5	A7400DM-15
16 mm	5	A7400DM-16
17 mm	5	A7400DM-17
18 mm	5	A7400DM-18
19 mm	5	A7400DM-19
20 mm	5	A7400DM-20
21 mm	5	A7400DM-21
22 mm	5	A7400DM-22
24 mm	5	A7400DM-24
6 mm	1	SBA7400DM-6
7 mm	1	SBA7400DM-7



		
8 mm	1	SBA7400DM-8
9 mm	1	SBA7400DM-9
10 mm	1	SBA7400DM-10
11 mm	1	SBA7400DM-11
12 mm	1	SBA7400DM-12
13 mm	1	SBA7400DM-13
14 mm	1	SBA7400DM-14
15 mm	1	SBA7400DM-15
16 mm	1	SBA7400DM-16
17 mm	1	SBA7400DM-17
18 mm	1	SBA7400DM-18
19 mm	1	SBA7400DM-19
20 mm	1	SBA7400DM-20
21 mm	1	SBA7400DM-21
22 mm	1	SBA7400DM-22

SB: Retail pack on a plastic info card

3/8" Square Drive Sockets with Imperial Hex Profile





7400SZ



		
1/4" in	1	7400SZ-1/4
5/16" in	1	7400SZ-5/16
11/32" in	1	7400SZ-11/32
3/8" in	1	7400SZ-3/8
7/16" in	1	7400SZ-7/16
1/2" in	1	7400SZ-1/2
9/16" in	1	7400SZ-9/16
5/8" in	1	7400SZ-5/8
11/16" in	1	7400SZ-11/16
3/4" in	1	7400SZ-3/4
13/16" in	1	7400SZ-13/16
7/8" in	1	7400SZ-7/8

3/8" Square Drive Sockets with Imperial Bi-Hex Profile



A7400DZ

		
1/4 in	5	A7400DZ-1/4
5/16 in	5	A7400DZ-5/16
3/8 in	5	A7400DZ-3/8



		
7/16 in	5	A7400DZ-7/16
1/2 in	5	A7400DZ-1/2
17/32 in	5	A7400DZ-17/32
9/16 in	5	A7400DZ-9/16
19/32 in	5	A7400DZ-19/32
5/8 in	5	A7400DZ-5/8
11/16 in	5	A7400DZ-11/16
3/4 in	5	A7400DZ-3/4
13/16 in	5	A7400DZ-13/16
7/8 in	5	A7400DZ-7/8
1/4 in	1	SBA7400DZ-1/4
5/16 in	1	SBA7400DZ-5/16
3/8 in	1	SBA7400DZ-3/8
7/16 in	1	SBA7400DZ-7/16
1/2 in	1	SBA7400DZ-1/2
17/32 in	1	SBA7400DZ-17/32
9/16 in	1	SBA7400DZ-9/16
19/32 in	1	SBA7400DZ-19/32
5/8 in	1	SBA7400DZ-5/8
11/16 in	1	SBA7400DZ-11/16
3/4 in	1	SBA7400DZ-3/4
13/16 in	1	SBA7400DZ-13/16
7/8 in	1	SBA7400DZ-7/8

SB: Retail pack on a plastic info card

3/8" Square Drive Swivel Sockets with metric Bi-Hex Profile





A7410DM

		
10 mm	1	A7410DM-10
11 mm	1	A7410DM-11
12 mm	1	A7410DM-12
13 mm	1	A7410DM-13
14 mm	1	A7410DM-14
15 mm	1	A7410DM-15
16 mm	1	A7410DM-16
17 mm	1	A7410DM-17
18 mm	1	A7410DM-18
19 mm	1	A7410DM-19

3/8" Square Drive Swivel Sockets with Imperial Bi-Hex Profile





A7410DZ

		
5/16 in	1	A7410DZ-5/16
3/8 in	1	A7410DZ-3/8
7/16 in	1	A7410DZ-7/16
1/2 in	1	A7410DZ-1/2
9/16 in	1	A7410DZ-9/16
5/8 in	1	A7410DZ-5/8
11/16 in	1	A7410DZ-11/16
3/4 in	1	A7410DZ-3/4

3/8" Square Drive Deep Sockets with Metric Bi-Hex Profile



A7402DM

		
7 mm	1	A7402DM-7
8 mm	1	A7402DM-8
9 mm	1	A7402DM-9
10 mm	5	A7402DM-10
11 mm	1	A7402DM-11
12 mm	1	A7402DM-12
13 mm	1	A7402DM-13
14 mm	1	A7402DM-14
15 mm	1	A7402DM-15
16 mm	1	A7402DM-16
17 mm	1	A7402DM-17
18 mm	1	A7402DM-18
19 mm	1	A7402DM-19
21 mm	1	A7402DM-21
7 mm	1	SBA7402DM-7
8 mm	1	SBA7402DM-8
9 mm	1	SBA7402DM-9
10 mm	1	SBA7402DM-10
11 mm	1	SBA7402DM-11
12 mm	1	SBA7402DM-12
13 mm	1	SBA7402DM-13
14 mm	1	SBA7402DM-14
15 mm	1	SBA7402DM-15
16 mm	1	SBA7402DM-16
17 mm	1	SBA7402DM-17
18 mm	1	SBA7402DM-18
19 mm	1	SBA7402DM-19

SB: Retail pack on a plastic info card



3/8" Square Drive Deep Sockets with Metric Hex Profile



A7402SM

Size	Quantity	Part Number
6 mm	10	A7402SM-6
7 mm	10	A7402SM-7
8 mm	10	A7402SM-8
9 mm	10	A7402SM-9
10 mm	1	A7402SM-10
11 mm	1	A7402SM-11
12 mm	10	A7402SM-12
13 mm	10	A7402SM-13
14 mm	10	A7402SM-14
15 mm	10	A7402SM-15
16 mm	10	A7402SM-16
17 mm	10	A7402SM-17
18 mm	10	A7402SM-18
19 mm	10	A7402SM-19
20 mm	10	A7402SM-20
22 mm	10	A7402SM-22

6	1	SBA7402SM-6
7	1	SBA7402SM-7
8	1	SBA7402SM-8
9	1	SBA7402SM-9
10	1	SBA7402SM-10
11	1	SBA7402SM-11
12	1	SBA7402SM-12
13	1	SBA7402SM-13
14	1	SBA7402SM-14
15	1	SBA7402SM-15
16	1	SBA7402SM-16
17	1	SBA7402SM-17
18	1	SBA7402SM-18
19	1	SBA7402SM-19
20	1	SBA7402SM-20
22	10	SBA7402SM-22

SB: Retail pack on a plastic info card

3/8" Square Drive Deep Sockets with Imperial Bi-Hex Profile



A7402DZ

1/4 in	1	A7402DZ-1/4
5/16 in	1	A7402DZ-5/16
3/8 in	1	A7402DZ-3/8
7/16 in	1	A7402DZ-7/16
1/2 in	1	A7402DZ-1/2
9/16 in	1	A7402DZ-9/16
19/32 in	1	A7402DZ-19/32
5/8 in	1	A7402DZ-5/8
11/16 in	1	A7402DZ-11/16
3/4 in	1	A7402DZ-3/4

13/16 in	1	A7402DZ-13/16
7/8 in	1	A7402DZ-7/8
1/4 in	1	SBA7402DZ-1/4
5/16 in	1	SBA7402DZ-5/16
3/8 in	1	SBA7402DZ-3/8
7/16 in	1	SBA7402DZ-7/16
1/2 in	1	SBA7402DZ-1/2
9/16 in	1	SBA7402DZ-9/16
19/32 in	1	SBA7402DZ-19/32
5/8 in	1	SBA7402DZ-5/8
11/16 in	1	SBA7402DZ-11/16
3/4 in	1	SBA7402DZ-3/4
13/16 in	1	SBA7402DZ-13/16
7/8 in	1	SBA7402DZ-7/8

SB: Retail pack on a plastic info card

3/8" Square Drive Sockets with TORX® Profile



7400TORX-E

E8	5	7400TORX-E8
E10	5	7400TORX-E10
E11	5	7400TORX-E11
E12	5	7400TORX-E12
E14	5	7400TORX-E14
E16	5	7400TORX-E16
E18	5	7400TORX-E18
E8	1	SB7400TORX-E8
E10	1	SB7400TORX-E10
E11	1	SB7400TORX-E11
E12	1	SB7400TORX-E12
E14	1	SB7400TORX-E14
E16	1	SB7400TORX-E16
E18	1	SB7400TORX-E18

SB: Retail pack on a plastic info card

3/8" Square Drive Speeders with Rotary Steel Handle



7752

435 mm	1	7752
--------	---	------

3/8" Square Drive Swivel Head Breaker Bars



7758

250 m	1	7758-10
250 m	1	SB7758-10

SB: Retail pack on a plastic info card

3/8" Square Drive Sliding T-Handles



7754

200 mm	10	7754-8
--------	----	--------

SB: Retail pack on a plastic info card

3/8" Square Drive Spinner Handles



7756

150 mm	6	7756
150 mm	1	SB7756

SB: With hanging clip

3/8" square drive Spinner metal handle



7756MH

150 mm	10	7756MH

3/8" Square Drive Knurled Extension Bars



776EX

26 mm	1	776EX-01*
76 mm	1	776EX-03*
101 mm	1	776EX-04*
200 mm	1	776EX-08*

3/8" Square Drive Universal Joints for Smooth Operations



7768

45 mm	50	7768

3/8" Square Drive Extension Bars



7760-7761-7762

75 mm	32	7760-3
125 mm	10	7760-5
252 mm	1	SB7762

SB: Retail pack

3/8" Square Drive Flexible Extension Bars

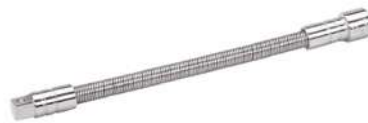

7759

200 mm	1	7759
200 mm	1	SB7759

SB: Retail pack

3/8" Square Drive to 1/4" Socket Decreasing Adaptors



7771

3/8	1/4	5	7771
3/8	1/4	1	SB7771

SB: Retail pack

3/8" Square Drive Wobbler Extension Bars



7760-W - 7761-W

75 mm	10	7760W-3
150 mm	10	7760W-6

3/8" Square Drive Universal Joints



7766

51.5 mm	1	7766
51.5 mm	1	SB7766

SB: Retail pack on a plastic info card

3/8" Square Drive to 1/2" Socket Increasing Adaptors



7772

3/8"	1/2"	40	7772

* Until stocks last



3/8" Square Drive to 1/2" Socket Increasing Flat Adaptors



8167

3/8	1/2	
		1 8167

3/8" Square Drive Adaptors for 1/4" Hex Screwdriver Bits



7773A

1/4 in	
20 7773A	
1/4 in	1 SB7773A

SB: Retail pack

3/8" Square Drive Adaptors for 5/16" Hex Screwdriver Bit



7106J

5/16 in	
1 7106J*	

Rail-Clips for 3/8" Sockets/Socket Drivers



C3/8

19 mm	
25 CLIPS-3/8	

3/8" Slim Head Reversible Ratchets with 72 Teeth and 5° Action Angle



7750SL

204 mm	72	
1 7750SL		

3/8" Pear Head Reversible Ratchets with 80 Teeth and 4.5° Action Angle



7750

207 mm	80	
1 7750		
207 mm	80	1 SB7750

SB: Retail pack

3/8" Round Head Reversible Ratchets with 72 Teeth and 5° Action Angle



7750RN

206 mm	72	
1 7750RN		
206 mm	72	1 SB7750RN

SB: Retail pack

3/8" Pear Head Reversible Ratchets with 60 Teeth and 6° Action Angle



7750QR

200 m	60	
10 7750QR		
200 m	60	1 SB7750QR

SB: Retail pack

3/8" Pear Head Reversible Ratchet with 60 Teeth Metal Handle



7750MH

150	60	
5 7750MH		

3/8" Swivel Head Ratchets with 72 Teeth and 5° Action Angle



8120-3/8

223 mm	72	10	8120-3/8

3/8" Flex Head Reversible Ratchets with 60 Teeth and 6° Action Angle



7710

278 mm	60	1	7710

19 mm Pass-Through Ratchet with 72 Teeth and 5° Action Angle



SBS19-THR

250 mm	60	50	SBS19-THR

SB: Retail pack

3/8" Square Drive Socket Drivers for Slotted Head Screw



7409F

6.4 mm	5	7409F-6.5
7.9 mm	5	7409F-8
9.5 mm	5	7409F-10
6.4 mm	1	SB7409F-6.5
7.9 mm	1	SB7409F-8
9.5 mm	1	SB7409F-10

SB: Retail pack on a plastic info card

3/8" Square Drive Socket Drivers for Phillips Head Screw



7409PH

1	5	7409PH-1
2	5	7409PH-2
3	5	7409PH-3
1	1	SB7409PH-1
2	1	SB7409PH-2
3	1	SB7409PH-3

SB: Retail pack on a plastic info card

3/8" Square Drive Socket Drivers for TORX® Head Screw



7409TORX

T20	5	7409TORX-T20
T25	5	7409TORX-T25
T27	5	7409TORX-T27
T30	5	7409TORX-T30
T40	5	7409TORX-T40

T45	5	7409TORX-T45
T50	5	7409TORX-T50
T20	1	SB7409TORX-T20
T25	1	SB7409TORX-T25
T27	1	SB7409TORX-T27
T30	1	SB7409TORX-T30
T40	1	SB7409TORX-T40
T45	1	SB7409TORX-T45
T50	1	SB7409TORX-T50

SB: Retail pack on a plastic info card

3/8" Square Drive Socket Drivers for TORX® Tamper-Resistant Head Screw



7409TORX-R

TR 27	5	7409TORX-R-T27
TR 30	5	7409TORX-R-T30
TR 40	5	7409TORX-R-T40
TR 45	5	7409TORX-R-T45
TR 50	5	7409TORX-R-T50
TR 27	1	SB7409TORX-R-T27
TR 30	1	SB7409TORX-R-T30
TR 40	1	SB7409TORX-R-T40
TR 45	1	SB7409TORX-R-T45
TR 50	1	SB7409TORX-R-T50

SB: Retail pack on a plastic info card

3/8" Square Drive Socket Driver Set for TORX® Tamper-Resistant Head Screw



7409TORX-TRR/

5	25 x 55 x 190 mm	1	7409TORX-TRR/S5

7409TORX-R-T40, 7409TORX-R-T30, 7409TORX-R-T27, 7409TORX-R-T50, 7409TORX-R-T45

* Until stocks last



3/8" Square Drive Deep Socket Drivers for TORX® Head Screw



7409TORX-L



T25	5	7409TORX-T25-L
T30	5	7409TORX-T30-L
T40	5	7409TORX-T40-L
T45	5	7409TORX-T45-L
T50	5	7409TORX-T50-L
T30	1	SB7409TORX-T30-L*
T40	1	SB7409TORX-T40-L*
T45	1	SB7409TORX-T45-L*
T50	1	SB7409TORX-T50-L*

SB: Retail pack on a plastic info card

3/8" Square Drive Socket Drivers for Hex Head Screw



7409M



3 mm	5	7409M-3
4 mm	5	7409M-4
5 mm	5	7409M-5
6 mm	5	7409M-6
7 mm	5	7409M-7
8 mm	5	7409M-8
10 mm	5	7409M-10
3 mm	1	SB7409M-3
4 mm	1	SB7409M-4
5 mm	1	SB7409M-5
6 mm	1	SB7409M-6
7 mm	1	SB7409M-7
8 mm	1	SB7409M-8
10 mm	1	SB7409M-10

SB: Retail pack on a plastic info card

3/8" Square Drive Ball Socket Drivers for Hex Head Screw



7409BH



4 mm	5	7409BH-4
5 mm	1	7409BH-5
6 mm	5	7409BH-6

8 mm	5	7409BH-8
10 mm	5	7409BH-10
4 mm	1	SB7409BH-4*
5 mm	1	SB7409BH-5*
6 mm	1	SB7409BH-6*
8 mm	1	SB7409BH-8*
10 mm	1	SB7409BH-10*

SB: Retail pack on a plastic info card

19 mm Pass Through Sockets with Metric Spline Profile



SBS19-TH



10 mm	1	SBS19-TH10
11 mm	1	SBS19-TH11
12 mm	1	SBS19-TH12
13 mm	1	SBS19-TH13
14 mm	1	SBS19-TH14
15 mm	1	SBS19-TH15
16 mm	1	SBS19-TH16
17 mm	1	SBS19-TH17
18 mm	1	SBS19-TH18
19 mm	1	SBS19-TH19
21 mm	1	SBS19-TH21
22 mm	1	SBS19-TH22
24 mm	1	SBS19-TH24

3/8" Square Drive Socket Drivers for Hex Head Screws



7409Z



1/8 in	47 mm	1	7409Z-1/8
5/32 in	47 mm	1	7409Z-5/32
3/16 in	47 mm	1	7409Z-3/16
7/32 in	47 mm	1	7409Z-7/32
1/4 in	47 mm	1	7409Z-1/4
3/8 in	50.5 mm	1	7409Z-3/8

19 mm Pass Through 75 mm extension



SBS19-TH75



75 mm	1	SBS19-TH75
-------	---	------------

SB: Retail pack

3/8" Square Drive Socket Driver Set on Rail for Hex Head Screw



7409MR/



7	25 x 55 x 190 mm	1	7409MR/S7
---	------------------	---	-----------

7409M-3, 7409M-4, 7409M-10, 7409M-8, 7409M-7, 7409M-6, 7409M-5

Ratcheting Adaptors with 52 Teeth for 3/8" Ratchet



7751



55 mm	175 g	10	7751
-------	-------	----	------

Spare Part Kit for 7755-3/8 3/8" Ratchet



7755-SO/1



6	7755-3/8	1	7755-SO/1
---	----------	---	-----------

Spare Part Kit for 7750SL 3/8" Ratchet



7750SL-SPARE

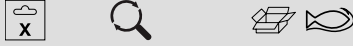

12 7750SL 1 7750SL-SPARE

Spare Part Kit for 7750 3/8" Ratchet



7750-SPARE

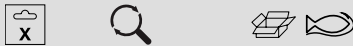

11 7750 1 7750-SPARE

Spare Part Kit for 7710 3/8" Ratchet



7710-SO/1

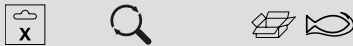

8 7710 1 7710-SO/1*

Spare Part Kit for 7750RN 3/8" Ratchet



7750RN-SPARE

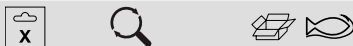

6 7750RN 1 7750RN-SPARE

1/2"

1/2" Square Drive Sockets with Metric Hex Profile and High Polished Finish



7800SM

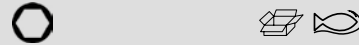

8 mm	10	7800SM-8
9 mm	10	7800SM-9
10 mm	10	7800SM-10
11 mm	10	7800SM-11
12 mm	10	7800SM-12
13 mm	10	7800SM-13
14 mm	10	7800SM-14
15 mm	10	7800SM-15
16 mm	10	7800SM-16
17 mm	10	7800SM-17
18 mm	10	7800SM-18
19 mm	10	7800SM-19
20 mm	10	7800SM-20
21 mm	10	7800SM-21
22 mm	10	7800SM-22
23 mm	10	7800SM-23
24 mm	10	7800SM-24
25 mm	10	7800SM-25
26 mm	10	7800SM-26
27 mm	10	7800SM-27
28 mm	10	7800SM-28
29 mm	10	7800SM-29
30 mm	10	7800SM-30
32 mm	10	7800SM-32
33 mm	10	7800SM-33
34 mm	10	7800SM-34
36 mm	10	7800SM-36

8 mm	1	SB7800SM-8
9 mm	1	SB7800SM-9
10 mm	1	SB7800SM-10
11 mm	1	SB7800SM-11
12 mm	1	SB7800SM-12
13 mm	1	SB7800SM-13
14 mm	1	SB7800SM-14
15 mm	1	SB7800SM-15
16 mm	1	SB7800SM-16
17 mm	1	SB7800SM-17
18 mm	1	SB7800SM-18
19 mm	1	SB7800SM-19
21 mm	1	SB7800SM-20
21 mm	1	SB7800SM-21
22 mm	1	SB7800SM-22
23 mm	1	SB7800SM-23
24 mm	1	SB7800SM-24
25 mm	1	SB7800SM-25
26 mm	1	SB7800SM-26
27 mm	1	SB7800SM-27
28 mm	1	SB7800SM-28
29 mm	1	SB7800SM-29
30 mm	1	SB7800SM-30
32 mm	1	SB7800SM-32
33 mm	1	SB7800SM-33
34 mm	1	SB7800SM-34
36 mm	1	SB7800SM-36

SB: Retail pack on a plastic info card

1/2" Square Drive Deep Sockets with Metric Hex Profile



7805SM

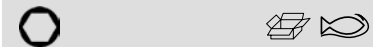

10 mm	10	7805SM-10
11 mm	10	7805SM-11
12 mm	10	7805SM-12
13 mm	10	7805SM-13
14 mm	10	7805SM-14
15 mm	10	7805SM-15
16 mm	10	7805SM-16
17 mm	10	7805SM-17
18 mm	10	7805SM-18
19 mm	10	7805SM-19
20 mm	10	7805SM-20
21 mm	10	7805SM-21
22 mm	10	7805SM-22
23 mm	10	7805SM-23
24 mm	10	7805SM-24
25 mm	10	7805SM-25
26 mm	10	7805SM-26
27 mm	10	7805SM-27
28 mm	10	7805SM-28
29 mm	10	7805SM-29
30 mm	10	7805SM-30
32 mm	10	7805SM-32
34 mm	10	7805SM-34

10 mm	1	SB7805SM-10
11 mm	1	SB7805SM-11
12 mm	1	SB7805SM-12
13 mm	1	SB7805SM-13
14 mm	1	SB7805SM-14
15 mm	1	SB7805SM-15
16 mm	1	SB7805SM-16
17 mm	1	SB7805SM-17
18 mm	1	SB7805SM-18
19 mm	1	SB7805SM-19
20 mm	1	SB7805SM-20
21 mm	1	SB7805SM-21
22 mm	1	SB7805SM-22
23 mm	1	SB7805SM-23
24 mm	1	SB7805SM-24
25 mm	1	SB7805SM-25
26 mm	1	SB7805SM-26
27 mm	1	SB7805SM-27
28 mm	1	SB7805SM-28
29 mm	1	SB7805SM-29
30 mm	1	SB7805SM-30
32 mm	1	SB7805SM-32
34 mm	1	SB7805SM-34

SB: Retail pack on a plastic info card

* Until stocks last



1/2" Square Drive Deep Sockets with Imperial Hex Profile



7805SZ

Size	Quantity	Part Number
1.3/16 in	1	7805SZ-1.3/16
1.1/4 in	1	7805SZ-1.1/4
1.5/16 in	1	7805SZ-1.5/16
1.3/8 in	1	7805SZ-1.3/8
1.7/16 in	1	7805SZ-1.7/16
1.1/2 in	1	7805SZ-1.1/2

Size	Quantity	Part Number
15 mm	1	SB7800DM-15
16 mm	1	SB7800DM-16
17 mm	1	SB7800DM-17
18 mm	1	SB7800DM-18
19 mm	1	SB7800DM-19
21 mm	1	SB7800DM-20
21 mm	1	SB7800DM-21
22 mm	1	SB7800DM-22
23 mm	1	SB7800DM-23
24 mm	1	SB7800DM-24
25 mm	1	SB7800DM-25
26 mm	1	SB7800DM-26
27 mm	1	SB7800DM-27
28 mm	1	SB7800DM-28
29 mm	1	SB7800DM-29
30 mm	1	SB7800DM-30
31 mm	1	SB7800DM-31
32 mm	1	SB7800DM-32
33 mm	1	SB7800DM-33
34 mm	1	SB7800DM-34
36 mm	1	SB7800DM-36

SB: Retail pack on a plastic info card

1/2" Square Drive Sockets with Metric Bi-Hex Profile



7800DM

Size	Quantity	Part Number
8 mm	10	7800DM-8
9 mm	10	7800DM-9
10 mm	10	7800DM-10
11 mm	10	7800DM-11
12 mm	10	7800DM-12
13 mm	10	7800DM-13
14 mm	10	7800DM-14
15 mm	10	7800DM-15
16 mm	10	7800DM-16
17 mm	10	7800DM-17
18 mm	10	7800DM-18
19 mm	10	7800DM-19
20 mm	10	7800DM-20
21 mm	10	7800DM-21
22 mm	10	7800DM-22
23 mm	10	7800DM-23
24 mm	10	7800DM-24
25 mm	10	7800DM-25
26 mm	10	7800DM-26
27 mm	10	7800DM-27
28 mm	10	7800DM-28
29 mm	10	7800DM-29
30 mm	10	7800DM-30
31 mm	10	7800DM-31
32 mm	10	7800DM-32
33 mm	10	7800DM-33
34 mm	10	7800DM-34
36 mm	10	7800DM-36
8 mm	1	SB7800DM-8
9 mm	1	SB7800DM-9
10 mm	1	SB7800DM-10
11 mm	1	SB7800DM-11
12 mm	1	SB7800DM-12
13 mm	1	SB7800DM-13
14 mm	1	SB7800DM-14

1/2" Square Drive Sockets with Imperial Bi-Hex Profile



7800DZ

Size	Quantity	Part Number
5/16 in	10	7800DZ-5/16
11/32 in	10	7800DZ-11/32
3/8 in	10	7800DZ-3/8
13/32 in	10	7800DZ-13/32
7/16 in	10	7800DZ-7/16
1/2 in	10	7800DZ-1/2
9/16 in	10	7800DZ-9/16
19/32 in	10	7800DZ-19/32
5/8 in	10	7800DZ-5/8
11/16 in	10	7800DZ-11/16
3/4 in	10	7800DZ-3/4
25/32 in	10	7800DZ-25/32
13/16 in	10	7800DZ-13/16
7/8 in	10	7800DZ-7/8
15/16 in	10	7800DZ-15/16
1 in	10	7800DZ-1
1 1/16 in	10	7800DZ-1.1/16
1 1/8 in	10	7800DZ-1.1/8
1 3/16 in	10	7800DZ-1.3/16
1 1/4 in	10	7800DZ-1.1/4
1.5/16 in	10	7800DZ-1.5/16
1.3/8 in	10	7800DZ-1.3/8
1.7/16 in	1	7800DZ-1.7/16
1.1/2 in	10	7800DZ-1.1/2
5/16 in	1	SB7800DZ-5/16
11/32 in	1	SB7800DZ-11/32
3/8 in	1	SB7800DZ-3/8
13/32 in	1	SB7800DZ-13/32
7/16 in	1	SB7800DZ-7/16
1/2 in	1	SB7800DZ-1/2
9/16 in	1	SB7800DZ-9/16
19/32 in	1	SB7800DZ-19/32
5/8 in	1	SB7800DZ-5/8
11/16 in	1	SB7800DZ-11/16
3/4 in	1	SB7800DZ-3/4

Size	Quantity	Part Number
25/32 in	1	SB7800DZ-25/32
13/16 in	1	SB7800DZ-13/16
7/8 in	1	SB7800DZ-7/8
15/16 in	1	SB7800DZ-15/16
1 in	1	SB7800DZ-1
1.1/16 in	1	SB7800DZ-1.1/16
1.1/8 in	1	SB7800DZ-1.1/8
1.3/16 in	1	SB7800DZ-1.3/16
1.1/4 in	1	SB7800DZ-1.1/4
1.5/16 in	1	SB7800DZ-1.5/16
1.3/8 in	1	SB7800DZ-1.3/8
1.7/16 in	1	SB7800DZ-1.7/16
1.1/2 in	1	SB7800DZ-1.1/2

SB: Retail pack on a plastic info card

1/2" Square Drive Sockets with Imperial Hex Profile



7800SZ



Size	Quantity	Part Number
3/8 in	10	7800SZ-3/8
7/16 in	10	7800SZ-7/16
1/2 in	10	7800SZ-1/2
9/16 in	10	7800SZ-9/16
5/8 in	10	7800SZ-5/8
11/16 in	10	7800SZ-11/16
3/4 in	10	7800SZ-3/4
13/16 in	10	7800SZ-13/16
7/8 in	10	7800SZ-7/8
15/16 in	10	7800SZ-15/16
1/2 in	10	7800SZ-1
1.1/16 in	10	7800SZ-1.1/16
1 1/8 in	10	7800SZ-1.1/8
1 3/16 in	10	7800SZ-1.3/16
1 1/4 in	10	7800SZ-1.1/4

1/2" Square Drive Deep Sockets with Metric Bi-Hex Profile



7805DM



Size	Quantity	Part Number
10 mm	10	7805DM-10
12 mm	10	7805DM-12
13 mm	10	7805DM-13
14 mm	10	7805DM-14
15 mm	10	7805DM-15



	 
16 mm	10 7805DM-16
17 mm	10 7805DM-17
18 mm	10 7805DM-18
19 mm	10 7805DM-19
21 mm	10 7805DM-21
22 mm	10 7805DM-22
23 mm	10 7805DM-23
24 mm	10 7805DM-24
26 mm	10 7805DM-26
27 mm	10 7805DM-27
30 mm	10 7805DM-30
32 mm	10 7805DM-32
34 mm	10 7805DM-34

1/2" Square Drive Sockets with Metric Spline Profile



7800SPL

	 
10 mm	1 SB7805DM-10
12 mm	1 SB7805DM-12
13 mm	1 SB7805DM-13
14 mm	1 SB7805DM-14
15 mm	1 SB7805DM-15
16 mm	1 SB7805DM-16
17 mm	1 SB7805DM-17
18 mm	1 SB7805DM-18
19 mm	1 SB7805DM-19
21 mm	1 SB7805DM-21
22 mm	1 SB7805DM-22
23 mm	1 SB7805DM-23
24 mm	1 SB7805DM-24
26 mm	1 SB7805DM-26
27 mm	1 SB7805DM-27
30 mm	1 SB7805DM-30
32 mm	1 SB7805DM-32
34 mm	1 SB7805DM-34



	 
10 mm	10 7800SPL-10
11 mm	10 7800SPL-11
12 mm	10 7800SPL-12
13 mm	10 7800SPL-13
14 mm	10 7800SPL-14
15 mm	10 7800SPL-15
16 mm	10 7800SPL-16
17 mm	10 7800SPL-17
18 mm	10 7800SPL-18
19 mm	10 7800SPL-19
20 mm	10 7800SPL-20
21 mm	10 7800SPL-21
22 mm	10 7800SPL-22
23 mm	10 7800SPL-23
24 mm	10 7800SPL-24
27 mm	10 7800SPL-27
30 mm	10 7800SPL-30
32 mm	10 7800SPL-32

SB: Retail pack on a plastic info card

1/2" Square Drive Deep Sockets with Imperial Bi-Hex Profile





7805DZ

	 
5/8 in	10 7805DZ-5/8*
11/16 in	10 7805DZ-11/16*
3/4 in	10 7805DZ-3/4*
13/16 in	10 7805DZ-13/16*
7/8 in	10 7805DZ-7/8*
15/16 in	10 7805DZ-15/16*
1 in	10 7805DZ-1*
1.1/16 in	10 7805DZ-1.1/16*
1.1/8 in	10 7805DZ-1.1/8*
1.13/16 in	10 7805DZ-1.3/16*
1.1/4 in	10 7805DZ-1.1/4*
1.5/16 in	10 7805DZ-1.5/16*
1.3/8 in	10 7805DZ-1.3/8*
1.7/16 in	10 7805DZ-1.7/16*
1.1/2 in	10 7805DZ-1.1/2*

1/2" Square Drive Sockets with TORX® Profile



7800TORX-E

	 
E8	1 7800TORX-E8
E10	1 7800TORX-E10
E11	1 7800TORX-E11
E12	1 7800TORX-E12
E14	1 7800TORX-E14
E16	1 7800TORX-E16
E18	1 7800TORX-E18
E20	1 7800TORX-E20
E24	1 7800TORX-E24
E8	1 SB7800TORX-E8
E10	1 SB7800TORX-E10
E11	1 SB7800TORX-E11
E12	1 SB7800TORX-E12
E14	1 SB7800TORX-E14
E16	1 SB7800TORX-E16
E18	1 SB7800TORX-E18
E20	1 SB7800TORX-E20
E24	1 SB7800TORX-E24

* Until stocks last

SB: Retail pack on a plastic info card

1/2" Square Drive Speeders with Rotary Steel Handle





8152-1/2

	 
425 mm	1 8152-1/2

1/2" Square Drive Swivel Head Breaker Bars



8157



	 
257 mm	1 8157-10
390 mm	1 8157-15
600 mm	1 8157-24
900 mm	10 8157-36
257 mm	1 SB8157-10
390 mm	1 SB8157-15
600 mm	1 SB8157-24
900 mm	1 SB8157-36

SB: Retail pack

1/2" Square Drive Swivel Head Breaker Bars with Matte Finish



8158

	 
270 mm	1 8158-10
390 mm	1 8158-15
270 mm	1 SB8158-10
390 mm	1 SB8158-15

SB: Retail pack



1/2" Square Drive Offset Handles



8178

180 mm	10	8178

1/2" Square Drive Extension Bars



8160

75 mm	10	8160-3
125 mm	8	8160-5
250 mm	10	8160-10
75 mm	1	SB8160-3
125 mm	1	SB8160-5
250 mm	1	SB8160-10

SB: Retail pack

1/2" Square Drive Universal Joints



8166

72 mm	10	8166
72 mm	1	SB8166

SB: Retail pack

1/2" Square Drive Sliding T-Handles



8154

280 mm	10	8154-11
280 mm	1	SB8154-11

SB: Retail pack

1/2" Square Drive Wobbler Extension Bars



8159-W - 8162-W

75 mm	10	8160W-3
125 mm	8	8160W-5
250 mm	10	8160W-10

1/2" Square Drive Universal Joints for Smooth Operations



8168

62 mm	40	8168

3/8" to 1/2" Adaptor Sliding Head



7772H

3/8"	1/2"	10	7772H

1/2" Square Drive Locking Extension Bars



8160-B

125 mm	1	8160-B

1/2" Square Drive to 3/8" Socket Decreasing Adaptors



8171

1/2"	3/8"	20	8171
1/2"	3/8"	1	SB8171

SB: Retail pack

Combination Stepped Hexagon Keys for Internal Lug Valve Sizes



8195-key



140 g



50 8195-KEY

For using with 8195-R

1/2" Square Drive to 3/4" Socket Increasing Adaptors



8172



1/2"



3/4"



10 8172

1/2"

3/4"

1 SB8172

SB: Retail pack

1/2" Square Drive to 3/4" Socket Increasing Flat Adaptors



8967



1/2"



3/4"



1 8967

1/2" Square Drive Adaptors for 5/16" Hex Screwdriver Bit



8174A



5/16 in



10 8174A

Rail-Clips for 1/2" Sockets/Socket Drivers



C1/2



19 mm



25 CLIPS-1/2

Spare Part Kit for 8169-1/2 Breaking Bar



SP120



75 g



1 SP120

1/2" Square Drive Socket Drivers for Slotted Head Screw 60 mm



7809F



0.8 mm

1 mm



8 mm

10 mm



5 7809F-8
5 7809F-10

Spare Part Kit for 8170-1/2 Breaking Bar



SP120XL



55 g



1 SP120XL

1/2" Square Drive Socket Drivers for Phillips Head Screw 23 mm



7809PH



2

3

4



1 7809PH-2
1 7809PH-3
1 7809PH-4



1/2" Square Drive Socket Drivers for Pozidriv Head Screw 60 mm



7809PZ



3 1 7809PZ-3*

1/2" Square Drive Socket Drivers for TORX® Head Screw



7809TORX



T20	1	7809TORX-T20
T25	1	7809TORX-T25
T27	1	7809TORX-T27
T30	1	7809TORX-T30
T40	1	7809TORX-T40
T45	1	7809TORX-T45
T50	1	7809TORX-T50
T55	1	7809TORX-T55
T60	1	7809TORX-T60
T70	10	7809TORX-T70
T20	1	SB7809TORX-T20
T25	1	SB7809TORX-T25
T27	1	SB7809TORX-T27
T30	1	SB7809TORX-T30
T40	1	SB7809TORX-T40
T45	1	SB7809TORX-T45
T50	1	SB7809TORX-T50
T55	1	SB7809TORX-T55
T60	1	SB7809TORX-T60

SB: Retail pack on a plastic info card

1/2" Socket Drivers for TORX® Head Screws



7809TORX L



T20	80 mm	1	7809TORX-T20-120
T25	80 mm	1	7809TORX-T25-120
T27	80 mm	1	7809TORX-T27-120
T30	80 mm	1	7809TORX-T30-120
T40	82 mm	1	7809TORX-T40-120
T45	80 mm	1	7809TORX-T45-120
T50	62 mm	1	7809TORX-T50-100
T50	80 mm	1	7809TORX-T50-120
T55	80 mm	1	7809TORX-T55-120
T60	80 mm	1	7809TORX-T60-120
T70	102 mm	5	7809TORX-T70-140
T70	80 mm	1	7809TORX-T70-120

1/2" Square Drive Socket Driver Set for TORX® Head Screw



7809TO



9 770 g 1 7809TO

7809TORX-T27, 7809TORX-T20, 7809TORX-T25, 7809TORX-T30, 7809TORX-T50, 7809TORX-T40, 7809TORX-T45, 7809TORX-T60, 7809TORX-T55

1/2" Square Drive Socket Drive Set for Torx® Head Screws - 9 pcs



7800TORX/9



46 x 130 x 195 mm 1 7800TORX/9

7800TORX-E8, 7800TORX-E10, 7800TORX-E11, 7800TORX-E12, 7800TORX-E14, 7800TORX-E16, 7800TORX-E18, 7800TORX-E20, 7800TORX-E24

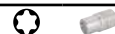

1/2" Square Drive Socket Drivers for Hex Head Screw



7809M



4 mm	10	7809M-4
5 mm	1	7809M-5
6 mm	1	7809M-6
7 mm	1	7809M-7
8 mm	1	7809M-8
9 mm	1	7809M-9
10 mm	1	7809M-10
12 mm	1	7809M-12
14 mm	1	7809M-14
17 mm	1	7809M-17
19 mm	1	7809M-19
4 mm	1	SB7809M-4
5 mm	1	SB7809M-5
6 mm	1	SB7809M-6
7 mm	1	SB7809M-7
8 mm	1	SB7809M-8
9 mm	1	SB7809M-9
10 mm	1	SB7809M-10
12 mm	1	SB7809M-12
14 mm	1	SB7809M-14
17 mm	1	SB7809M-17
19 mm	1	SB7809M-19

SB: Retail pack on a plastic info card

1/2" Socket Drivers for Hex Head Screws



7809M-L



4 mm	80 mm	1	7809M-4-120
5 mm	80 mm	1	7809M-5-120
5 mm	143 mm	1	7809M-5-180
6 mm	80 mm	1	7809M-6-120
7 mm	63 mm	1	7809M-7-100
7 mm	80 mm	1	7809M-7-120

Hex Head	Length	Qty	Part No.
8 mm	83 mm	1	7809M-8-120
10 mm	80 mm	1	7809M-10-120
12 mm	80 mm	1	7809M-12-120
14 mm	80 mm	10	7809M-14-120
17 mm	80 mm	10	7809M-17-120
19 mm	80 mm	8	7809M-19-120

1/2" Square Drive Deep Socket Drivers for Metric Hex Head Screw



SB7809M-XX-120

Hex Head	Length	Qty	Part No.
4 mm	80 mm	1	SB7809M-4-120
5 mm	63 mm	1	SB7809M-5-100*
5 mm	80 mm	1	SB7809M-5-120
5 mm	140 mm	1	SB7809M-5-180
6 mm	80 mm	1	SB7809M-6-120
7	80 mm	1	SB7809M-7-120
8 mm	81 mm	1	SB7809M-8-120
10 mm	80 mm	1	SB7809M-10-120
12 mm	80 mm	1	SB7809M-12-120
14 mm	80 mm	1	SB7809M-14-120
17 mm	80 mm	1	SB7809M-17-120
19 mm	80 mm	1	SB7809M-19-120

SB: Retail pack

1/2" Square Drive Socket Driver Set for Hex Head Screw



7808HM

Qty	Weight	Part No.
8	810 g	7808HM

7809M-4, 7809M-6, 7809M-8, 7809M-7, 7809M-5, 7809M-10, 7809M-12, 7809M-14

1/2" Square Drive Socket Drivers for Imperial Hex Head Screw



7809Z

Size	Qty	Part No.
1/4 in	1	7809Z-3/16
5/16 in	1	7809Z-1/4
3/8 in	1	7809Z-5/16
7/16 in	1	7809Z-3/8
1/2 in	1	7809Z-7/16
17/32 in	1	7809Z-1/2
9/16 in	1	7809Z-17/32
19/32 in	1	7809Z-9/16
5/8 in	1	7809Z-19/32
	1	7809Z-5/8

1/2" Square Drive Socket Drivers for Multipoint Head Screw



7809XZN

Size	Qty	Part No.
6	1	7809XZN-6
8	1	7809XZN-8
8	1	7809XZN-8-100
10	1	7809XZN-10
10	1	7809XZN-10-100
12	1	7809XZN-12
12	1	7809XZN-12-100
14	1	7809XZN-14
14	1	7809XZN-14-100
16	1	7809XZN-16
18	1	7809XZN-18

1/2" Slim Head Reversible Ratchets with 72 Teeth and 5° Action Angle



8150SL

Length	Teeth	Qty	Part No.
264 mm	72	1	8150SL

1/2" Pear Head Reversible Ratchets with 80 Teeth and 4.5° Action Angle



8150-1/2

Length	Teeth	Qty	Part No.
269 mm	80	1	8150-1/2
269 mm	80	1	SB8150-1/2

SB: With hanging clip

1/2" Round Head Reversible Ratchets with 72 Teeth and 5° Action Angle



8150RN-1/2

Length	Teeth	Qty	Part No.
267 mm	72	1	8150RN-1/2
267 mm	72	1	SB8150RN-1/2

SB: With hanging clip

1/2" Pear Head Reversible Ratchets with 60 Teeth and 6° Action Angle



8150QR

Length	Teeth	Qty	Part No.
250 m	60	3	8150QR
250 m	60	1	SB8150QR

SB: Retail pack

* Until stocks last



1/2" Set of Accesories - 4 pcs



SB81-SET1

35 x 170 x 450 mm 8 SB81-SET1

SB: Retail pack

8150QR	
8158-15	
8160-10	
8172	

1/2" Pear Head Reversible Ratchet with 60 Teeth Metal Handle



8150MH

200 mm 60 5 8150MH

1/2" Swivel Head Ratchets with 72 Teeth and 5° Action Angle



8120-1/2

266 mm 72 12 8120-1/2

1/2" Reversible Ratchets with 60 Teeth and Dual Pawl



8195-R

260 mm 60 1 8195-R

Radiator Valve Ratchet Set - 3 Pcs/Plastic Pouch



8195-SET

350 x 20 x 80 mm 5 8195-SET

8195-R	
8195-SQ	
8195-KEY	

1/2" Flex Head Reversible Ratchets with 32 Teeth and 11.25° Action Angle



8110H-1/2

440 mm 32 1 8110H-1/2

Fitting Square Drives for 8193-1/2 1/2" Ratchet



8194-1/2

32 mm 1 8194-1/2*

Fitting Square Drives for 8195-R 1/2" Reversible Ratchet



8195-SQ

37.5 mm 40 g 25 8195-SQ

Ratcheting Adaptors with 52 Teeth for 1/2" Ratchet



8151-1/2

71 mm 1 8151-1/2

Spare Part Kit for 8155-1/2 1/2" Ratchet



8155-SO/1

6	8155-1/2	1 8155-SO/1

Spare Part Kit for 8150RN-1/2 1/2" Ratchet



8150RN-1/2-SPARE

6	8150RN-1/2	1 8150RN-1/2-SPARE

3/4" Square Drive Sockets with Imperial Hex Profile



8900SZ

3/4 in	1 8900SZ-3/4*
13/16 in	1 8900SZ-13/16*
1 in	1 8900SZ-1*
1.7/16 in	1 8900SZ-1.7/16*
1.9/16 in	1 8900SZ-1.9/16*
1.7/8 in	1 8900SZ-1.7/8*
2 in	1 8900SZ-2*

Spare Part Kit for 8150SL 1/2" Ratchet



8150SL-SPARE

12	8150SL	1 8150SL-SPARE

3/4"

3/4" Square Drive Sockets with Metric Hex Profile



8900SM

19 mm	1 8900SM-19
22 mm	1 8900SM-22
23 mm	1 8900SM-23
24 mm	5 8900SM-24
26 mm	5 8900SM-26
27 mm	5 8900SM-27
28 mm	1 8900SM-28
29 mm	1 8900SM-29
30 mm	5 8900SM-30
32 mm	5 8900SM-32
33 mm	1 8900SM-33
34 mm	1 8900SM-34
35 mm	1 8900SM-35
36 mm	5 8900SM-36
38 mm	1 8900SM-38
41 mm	5 8900SM-41
42 mm	1 8900SM-42
46 mm	1 8900SM-46
50 mm	1 8900SM-50
55 mm	1 8900SM-55
60 mm	1 8900SM-60

3/4" Square Drive Sockets with Metric Bi-Hex Profile



8900DM

19 mm	1 8900DM-19
21 mm	5 8900DM-21
22 mm	1 8900DM-22
23 mm	1 8900DM-23
24 mm	1 8900DM-24
25 mm	1 8900DM-25
26 mm	1 8900DM-26
27 mm	1 8900DM-27
28 mm	1 8900DM-28
29 mm	1 8900DM-29
30 mm	5 8900DM-30
32 mm	1 8900DM-32
33 mm	1 8900DM-33
34 mm	1 8900DM-34
35 mm	1 8900DM-35
36 mm	1 8900DM-36
37 mm	1 8900DM-37
38 mm	1 8900DM-38
40 mm	1 8900DM-40
41 mm	5 8900DM-41
42 mm	1 8900DM-42
46 mm	1 8900DM-46
47 mm	1 8900DM-47
50 mm	5 8900DM-50
52 mm	1 8900DM-52
40 mm	3 8900DM-54
55 mm	1 8900DM-55
56 mm	1 8900DM-56
60 mm	5 8900DM-60

Spare Part Kit for 8150-1/2 1/2" Ratchet



8150-1/2-SPARE

11	8150-1/2	1 8150-1/2-SPARE

* Until stocks last



3/4" Square Drive Sockets with Imperial Bi-Hex Profile



8900DZ



3/4 in	1	8900DZ-3/4
13/16 in	1	8900DZ-13/16
7/8 in	1	8900DZ-7/8
15/16 in	1	8900DZ-15/16
31/32 in	1	8900DZ-31/32
1 in	1	8900DZ-1
1 1/16 in	1	8900DZ-1.1/16
1 1/8 in	1	8900DZ-1.1/8
1 3/16 in	1	8900DZ-1.3/16
1 1/4 in	1	8900DZ-1.1/4
1 5/16 in	5	8900DZ-1.5/16
1 3/8 in	1	8900DZ-1.3/8
1 7/16 in	1	8900DZ-1.7/16
1 1/2 in	1	8900DZ-1.1/2
1.9/16 in	1	8900DZ-1.9/16
1 5/8 in	1	8900DZ-1.5/8
1.11/16 in	1	8900DZ-1.11/16
1 3/4 in	1	8900DZ-1.3/4
1 13/16 in	1	8900DZ-1.13/16
1 7/8 in	1	8900DZ-1.7/8
2 in	1	8900DZ-2
2.1/16 in	1	8900DZ-2.1/16
2.1/8 in	1	8900DZ-2.1/8
2.3/16 in	1	8900DZ-2.3/16
2.1/4 in	1	8900DZ-2.1/4
2.3/8 in	1	8900DZ-2.3/8

3/4" Square Drive Sliding T-Handles



8954



390 mm

1 8954-15

3/4" Square Drive Sliding T-Heads



8954A



62 mm

1 8954A

3/4" Square Drive Flex Heads for 8957 Breaker Bar



8957A



140 mm

1 8957A

3/4" Square Drive Offset Handles



8963



415 mm

1 8963

3/4" Square Drive Extension Bars



8960



200 mm

1 8960-8

400 mm

12 8960-16

3/4" Universal Handles with High Polished Finish



8953



405 mm

1 8953-16

3/4" Square Drive Flex Head Breaker Bars



8957-19



480 mm

1 8957-19

3/4" Square Drive Flex Heads for 8958 Breaker Bar



8958A



125 mm

1 8958A*

3/4" Square Drive Universal Joints



8966



120 mm

1 8966

3/4" Square Drive Telescopic Handle with Matte Finish



8953E-32



495 to 810 mm

1 8953E-32

3/4" Square Drive to 1/2" Socket Decreasing Adaptors



8971

3/4"	1/2"	1	8971

3/4" Square Drive to 1" Socket Increasing Adaptors



8972

3/4"	1"	1	8972

3/4" Round Head Reversible Ratchets with 72 Teeth and 5° Action Angle



8950RN

525 mm	72	1	8950RN

3/4" ratchets.



8955N

525 mm	24	1	8955N

Round Heads with 72 Teeth for 3/4" Reversible Ratchet



8950RN/A

170 mm	72	1	8950RN/A

Pear Heads with 24 Teeth for 3/4" Reversible Ratchet



8955N/A

152 mm	24	1	8955N/A

3/4" Universal handle



8955N/B

1160 g	390 mm	5	8955N/B

Ratcheting Adaptors with 72 Teeth for 3/4" Ratchet



8951

95.5 mm	1	8951

Spare Part Kit for 8950 N and 8950N/A 3/4" Ratchet



8950NA-SO/2

8	8950N, 8950N/A	1	8950NA-SO/2*

Spare Part Kit for 8955N and 8955N/A 3/4" Ratchet



8955N-SPARE

11	8955N, 8955N/A	1	8955N-SPARE

* Until stocks last



1"

1" Square Drive Sockets with Metric Hex Profile



9500SM



41 mm	1	9500SM-41
46 mm	1	9500SM-46
50 mm	1	9500SM-50
54 mm	1	9500SM-54
55 mm	1	9500SM-55
58 mm	1	9500SM-58
60 mm	1	9500SM-60
63 mm	1	9500SM-63
65 mm	1	9500SM-65
67 mm	1	9500SM-67
70 mm	1	9500SM-70
71 mm	1	9500SM-71
75 mm	1	9500SM-75
77 mm	1	9500SM-77
80 mm	1	9500SM-80
82 mm	1	9500SM-82

1" Square Drive Sliding T-Handles with Matte Finish



9555



508 mm



1 9555

1" Square Drive to 3/4" Socket Decreasing Adaptors with Matte Finish



9565AB



3/4"

1 9565AB

1" Square Drive Sockets with Imperial Bi-Hex Profile



9500DZ



1.5/8 in	1	9500DZ-1.5/8
1.13/16 in	1	9500DZ-1.13/16
1.7/8 in	1	9500DZ-1.7/8
2 in	1	9500DZ-2
2.1/8 in	1	9500DZ-2.1/8
2.3/16 in	1	9500DZ-2.3/16
2.1/4 in	1	9500DZ-2.1/4
2.3/8 in	1	9500DZ-2.3/8
2.1/2 in	1	9500DZ-2.1/2
2.9/16 in	1	9500DZ-2.9/16
2.5/8 in	1	9500DZ-2.5/8
2.3/4 in	1	9500DZ-2.3/4
2.15/16 in	1	9500DZ-2.15/16
3 in	1	9500DZ-3
3.1/8 in	1	9500DZ-3.1/8

1" Square Drive Sliding T-Heads



9555AB



78x78x78 mm



1 9555AB

1" Round Head Reversible Ratchets with 72 Teeth and 5° Action Angle



9550N



640 mm



72



1 9550N

1" Square Drive Extension Bars with Matte Finish



9560AB/9563AB



200 mm

440 mm



1 9560AB

1 9563AB

1" Square Drive Interchangeable Handle Bar for Ratcheting Heads



9550N/B



1960 g



1 9550N/B

Round Heads with 72 Teeth for 1" Reversible Ratchet



9550N/A

195 mm	72	1	9550N/A

Spare Part Kit for 9550 N and 9550N/A 1" Ratchet



9550N-SPARE

2	9550N, 9550N/A	1	9550N-SPARE

EMPTY SOCKET SET CASES

Empty Cases with Divider for Socket Set



-CASE

110 x 375 x 430 mm	2200 g	1	S103-CASE
70 x 160 x 280 mm	520 g	6	S160-BOX
100 x 215 x 370 mm	1120 g	1	S240AF-CASE*
70 x 160 x 280 mm	500 g	1	S330-CASE*

110 x 320 x 375 mm	1620 g	1	S410-CASE*
100 x 215 x 375 mm	1120 g	1	S460-CASE
100 x 215 x 375 mm	1120 g	1	S560-CASE
110 x 375 x 430 mm	2200 g	1	S108-CASE*
110 x 375 x 430 mm	2200 g	1	SLX17-CASE
100 x 215 x 375 mm	1120 g	1	S330L-CASE*

Injected Thin Walled Empty Spare Cases



4750IB

35 x 80 x 100 mm	1	SPAR-CASE-A7
35 x 85 x 160 mm	1	SPAR-CASE-A6
49 x 152 x 280 mm	1	SPAR-CASE-A4

SCAFFOLDING WRENCHES

Double Metric Bi-Hex Scaffolding Wrench



SC2RM

13-17 mm	10	SC2RM-13-17
15-17 mm	10	SC2RM-15-17
19-22 mm	10	SC2RM-19-22
27-30 mm	1	SC2RM-27-30

* Until stocks last





BAHCO®



Torque Tools



DIGITAL TORQUE WRENCHES

Digital Torque and Angle Slim Bluetooth® Wrench with Memory and Rectangular Interchangeable Head



TAWMB MICRO

mm	Nm	Nm		
9x12 mm	1.5-30 N·m	0.01 N·m	1	TAWMB930M
9x12 mm	6.8-135 N·m	0.1 N·m	1	TAWMB9135M

Accuracy: 20% to 100% of full scale

Digital Torque and Angle Bluetooth® Wrench with Memory and Rectangular Interchangeable Head



TAWMB14_24

mm	Nm	Nm		
14x18 mm	17-340 N·m	1 N·m	1	TAWMB14340
24x32 mm	32.5-650 N·m	1 N·m	1	TAWMB24650
24x32 mm	40-800 N·m	1 N·m	1	TAWMB24800

Accuracy: 20% to 100% of full scale

Electronic Torque and Angle Slim Wrench with Memory/USB and Fixed Ratchet Head



TAWM MICRO

mm	Nm	Nm		
1/4 in	0.6-12 N·m	0.01 N·m	1	TAWM1412M
1/4 in	1.5-30 N·m	0.01 N·m	1	TAWM1430M
3/8 in	6.8-135 N·m	0.1 N·m	1	TAWM38135M

Accuracy: 20% to 100% of full scale

Electronic Torque and Angle Slim Wrench with Memory/USB and Rectangular Interchangeable Head



TAWM9 MICRO

mm	Nm	Nm		
9x12 mm	0.6-12 N·m	0.01 N·m	1	TAWM912M
9x12 mm	1.5-30 N·m	0.01 N·m	1	TAWM930M
9x12 mm	6.8-135 N·m	0.1 N·m	1	TAWM9135M

Accuracy: 20% to 100% of full scale

Electronic Torque and Angle Wrench with Memory/USB and Fixed Ratchet Head. with memory and USB data download



TAWM

	Nm	Nm		
1/4 in	1.5-30 N·m	1 N·m	1	TAWM1430*
3/8 in	7-135 N·m	1 N·m	1	TAWM38135
1/2 in	17-340 N·m	1 N·m	1	TAWM12340
3/4 in	40-800 N·m	1 N·m	1	TAWM34800

Accuracy: 20% to 100% of full scale

Electronic Torque and Angle Wrench with Memory/USB and Rectangular Interchangeable Head



TAWM9_14_24

mm	Nm	Nm		
9x12 mm	7-135 N·m	1 N·m	1	TAWM9135
14x18 mm	17-340 N·m	1 N·m	1	TAWM14340
24x32 mm	40-800 N·m	1 N·m	1	TAWM24800

Accuracy: 20% to 100% of full scale

Electronic torque angle wrench in aluminium. with memory and USB data download



TAWM alu

1.5-30 N·m	9x12 mm	1/4 in	1	TAWM930A*

Electronic Torque and Angle Wrench with Fixed Ratchet Head



TAW

3/8 in	7-135 N·m	1 N·m	1	TAW38135
1/2 in	17-340 N·m	1 N·m	1	TAW12340
3/4 in	40-800 N·m	1 N·m	1	TAW34800

Accuracy: 20% to 100% of full scale

Electronic Torque and Thin Angle Wrench with Fixed Ratchet Head



TAW MICRO

1/4 in	0.6-12 N·m	0.01 N·m	1	TAW1412M
1/4 in	1.5-30 N·m	0.01 N·m	1	TAW1430M
3/8 in	6.8-135 N·m	0.1 N·m	1	TAW38135M

Accuracy: 20% to 100% of full scale

Electronic Torque and Angle Wrench with Rectangular Interchangeable Head



TAW9 14 24

9x12 mm	7-135 N·m	1 N·m	1	TAW9135
14x18 mm	17-340 N·m	1 N·m	1	TAW14340
24x32 mm	40-800 N·m	1 N·m	1	TAW24800

Accuracy: 20% to 100% of full scale

Electronic Torque and Angle Slim Wrench with Rectangular Interchangeable Head



TAW9 MICRO

9x12 mm	0.6-12 N·m	0.01 N·m	1	TAW912M
9x12 mm	1.5-30 N·m	0.01 N·m	1	TAW930M
9x12 mm	6.8-135 N·m	0.1 N·m	1	TAW9135M

Accuracy: 20% to 100% of full scale

Electronic Torque Wrench with Rectangular Interchangeable Head



IZO-D

1/4 in	3-30 N·m	0.1 N·m	1	IZO-D-30
3/8 in	13.5-135 N·m	1 N·m	1	IZO-D-135
1/2 in	20-200 N·m	1 N·m	1	IZO-D-200
1/2 in	34-340 N·m	1 N·m	1	IZO-D-340

* Until stocks last



Electronic Torque Wrench with Fixed Ratchet Head. ring spanner



IZO-DR

mm	Nm	Nm	
3/4 in	81-810 N·m	1 N·m	1 IZO-DR-810

MECHANICAL TORQUE WRENCHES

Mechanical Adjustable Torque Click Wrench with Window Scale and Fixed Ratchet Head



74WR-15/74WR-25

mm	Nm	Nm	
1/4 in	3-15 N·m	0.1 N·m	1 74WR-15
1/4 in	5-25 N·m	0.2 N·m	1 74WR-25

Mechanical Adjustable Torque Click Wrench with Window Scale and Fixed Push-Through Ratchet Head



74WR-50/74WR-400

mm	Nm	Nm	
3/8"	10-50 N·m	0.5 N·m	1 74WR-50
3/8"	20-100 N·m	1 N·m	1 74WR-100B
1/2"	20-100 N·m	1 N·m	1 74WR-100
1/2"	40-200 N·m	2 N·m	1 74WR-200
1/2"	60-300 N·m	2 N·m	1 74WR-300
1/2"	60-340 N·m	5 N·m	1 74WR-340
3/4"	80-400 N·m	5 N·m	1 74WR-400

Mechanical Adjustable Torque Click Wrench with Window Scale and Rectangular Interchangeable Head



74W9/74W14

mm	Nm	Nm	
9x12 mm	3-15 N·m	0.2 N·m	1 74W9-15
9x12 mm	5-25 N·m	0.2 N·m	1 74W9-25
9x12 mm	10-50 N·m	0.5 N·m	1 74W9-50
9x12 mm	20-100 N·m	1 N·m	1 74W9-100
9x12 mm	40-200 N·m	1 N·m	1 74W9-200
14x18 mm	40-200 N·m	2 N·m	1 74W14-200
14x18 mm	60-300 N·m	2 N·m	1 74W14-300
14x18 mm	80-400 N·m	5 N·m	1 74W14-400

Mechanical Adjustable Torque Click Wrench with Window Scale and Spigot Interchangeable Head



74WS-15/74WS-300

mm	Nm	Nm	
16 mm	3-15 N·m	0.2 N·m	1 74WS-15
16 mm	5-25 N·m	0.2 N·m	1 74WS-25
16 mm	10-50 N·m	0.5 N·m	1 74WS-50
16 mm	20-100 N·m	1 N·m	1 74WS-100
16 mm	40-200 N·m	2 N·m	1 74WS-200
16 mm	60-300 N·m	2 N·m	1 74WS-300

Mechanical Adjustable Torque Click Wrench with Marked Scale and Fixed Ratchet Head

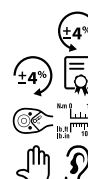

7455

mm	Nm	Nm	
1/4 in	1-5 N·m	0.05 N·m	1 7455-5
1/4 in	3-15 N·m	0.1 N·m	1 7455-15
1/4 in	4-20 N·m	0.1 N·m	1 7455-20
1/4 in	5-25 N·m	0.1 N·m	1 7455-25
3/8 in	12-60 N·m	0.5 N·m	1 7455-60

3/8 in	20-100 N·m	0.5 N·m	1	7455-100
1/2 in	20-100 N·m	0.5 N·m	1	7455-100A
1/2 in	40-200 N·m	2 N·m	1	7455-200
1/2 in	60-300 N·m	2 N·m	1	7455-300
1/2 in	68-340 N·m	2 N·m	1	7455-340
3/4 in	100-500 N·m	5 N·m	1	7455-500
3/4 in	160-800 N·m	5 N·m	1	7455-800
1 in	200-1000 N·m	10 N·m	1	7455-1000

Mechanical Adjustable Torque Click Wrench with Marked Scale, Fixed Ratchet Head and 2 Section Handle

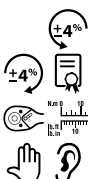

7455-1500

1 in	300-1500 N·m	10 N·m	1	7455-1500

Mechanical Adjustable Torque Click Wrench with Marked Scale and Fixed Square Drive Head

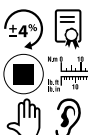

7455-2500

1 in	500-2500 N·m	10 N·m	1	7455-2500

Mechanical Adjustable Torque Click Wrench with Marked Scale and Interchangeable Head



7465

9x12 mm	1-5 N·m	0.05 N·m	1	7465-5
9x12 mm	3-15 N·m	0.1 N·m	1	7465-15
9x12 mm	6-30 N·m	0.1 N·m	1	7465-30
9x12 mm	12-60 N·m	0.5 N·m	1	7465-60

9x12 mm	20-100 N·m	0.5 N·m	1	7465-100
14x18 mm	40-200 N·m	2 N·m	1	7465-200
14x18 mm	68-340 N·m	2 N·m	1	7465-340
24x32 mm	160-800 N·m	5 N·m	1	7465-800

Mechanical Adjustable Torque Click Wrench with Marked Scale, Interchangeable Head and 2 Sections Handle



7465-1500

27x36 mm	300-1500 N·m	10 N·m	1	7465-1500

Mechanical Adjustable Torque Click Wrench with Marked Scale and Flex Ratchet Head



7456

3/8 in	10-80 lbf·ft	0.5 lbf·ft	1	7456-80LB

Mechanical Adjustable Free Hand Point Torque Click Wrench with Fixed Ratchet Head



75R3/75R1

3/4" in	130-650 N·m	5 N·m	1	75R3-650
3/4" in	200-800 N·m	10 N·m	1	75R3-800
3/4" in	300-1000 N·m	10 N·m	1	75R3-1000
1" in	500-1500 N·m	10 N·m	1	75R1-1500



Mechanical Adjustable Free Hand Point Torque Click Wrench with Spigot Interchangeable Head



75S-650

22 mm	130-650 N·m	5 N·m	1	75S-650

Mechanical Adjustable Breaking Torque Wrench with Fixed Ratchet Head and Double Adjusting Bar



76R1-2000

1 in	900-2000 N·m	50 N·m	1	76R1-2000

Mechanical Adjustable Window Scale Breaking Torque Wrench with Fixed Ratchet Head

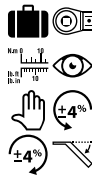

76R3

3/4-1 in	120-600 N·m	10 N·m	1	76R3-600
3/4-1 in	200-800 N·m	10 N·m	1	76R3-800
3/4-1 in	300-1000 N·m	20 N·m	1	76R3-1000

Mechanical Adjustable Window Scale Breaking Torque Click Wrench with Spigot Interchangeable Head



76S-600

22 mm	120-600 N·m	10 N·m	1	76S-600

Mechanical Torque Wrench with Dial Scale, Fixed Square Drive Head & Metal Handle



7454 M

1/4 in	0.7-3.5 N·m	0.1 N·m	1	7454-3.5*
1/4 in	1.68-8.4 N·m	0.2 N·m	1	7454-8.4*
3/8 in	3.4-17 N·m	0.5 N·m	1	7454-17*
3/8 in	6.4-32 N·m	0.5 N·m	1	7454-32*
3/8 in	14-70 N·m	1 N·m	1	7454-70A*
1/2 in	28-140 N·m	5 N·m	1	7454-140A*
1/2 in	46-230 N·m	10 N·m	1	7454-230*
3/4 in	160-800 N·m	20 N·m	1	7454-800A*

Mechanical Adjustable Breaking Torque Wrench with Fixed Ratchet Head



76R3-1500

3/4 in	700-1500 N·m	25 N·m	1	76R3-1500

Mechanical Torque Wrench with Dial Scale, Fixed Square Drive Head and Metal Handle

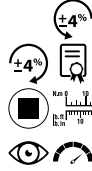

7454-480/7454-800

3/4 in	100-480 N·m	10 N·m	1	7454-480*

Mechanical Torque Wrench with Dial Scale/LED and Fixed Square Drive Head and 2 Sections Handle



7454-1400E

1 in	275-1400 N·m	25 N·m	1	7454-1400E*

Mechanical Torque Wrench with Dial Scale, Fixed Square Drive Head and 2 Sections Handle

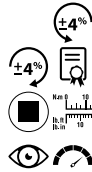

7454-1400

1 in	275-1400 N·m	25 N·m	1	7454-1400*

Mechanical Preset Torque Click Wrench with Fixed Ratchet Head



74PR-20

1/4 in	4-20 N·m	219 mm	1	74PR-20

Mechanical Torque Wrench with Dial Scale/LED and Fixed Square Drive Head



7454-800E

3/4 in	160-800 N·m	20 N·m	1	7454-800E*

Mechanical Preset Torque Click Wrench with Fixed Push-Through Ratchet Head



74PR-60/74PR-400

3/8 in	12-60 N·m	295 mm	1	74PR-60
1/2 in	12-60 N·m	301 mm	1	74PR-60A
3/8 in	20-100 N·m	335 mm	1	74PR-100
1/2 in	20-100 N·m	342 mm	1	74PR-100A
1/2 in	40-200 N·m	425 mm	1	74PR-200
1/2 in	60-300 N·m	668 mm	1	74PR-300
3/4 in	80-400 N·m	675 mm	1	74PR-400

* Until stocks last



Mechanical Preset Torque Click Wrench with Rectangular Interchangeable Head and Plastic Handle



74P9-20

mm	N·m	L	
9x12 mm	4-20 N·m	205 mm	1 74P9-20

Mechanical Preset Torque Click Wrench with Spigot Interchangeable Head and Rubber Handle



74PS-60/74PS-300

mm	N·m	L	
16 mm	12-60 N·m	283 mm	1 74PS-60
16 mm	20-100 N·m	324 mm	1 74PS-100
16 mm	40-200 N·m	405 mm	1 74PS-200
16 mm	60-300 N·m	643 mm	1 74PS-300

Mechanical Preset Torque Click Wrench with Rectangular Interchangeable Head and Rubber Handle



74P9-60/74P14-400

mm	N·m	L	
9x12 mm	12-60 N·m	286 mm	1 74P9-60
9x12 mm	20-100 N·m	326 mm	1 74P9-100
14x18 mm	40-200 N·m	403 mm	1 74P14-200
14x18 mm	60-300 N·m	534 mm	1 74P14-300
14x18 mm	80-400 N·m	652 mm	1 74P14-400

Mechanical Preset Free Hand Point Torque Click Wrench with Fixed Ratchet Head



75P3/75P1

mm	N·m	L	
3/4 in	130-650 N·m	848 mm	1 75P3-650
3/4 in	200-800 N·m	1030 mm	1 75P3-800
3/4 in	300-1000 N·m	1238 mm	1 75P3-1000
1 in	500-1500 N·m	1563 mm	1 75P1-1500

Mechanical Preset Torque Click Wrench with Spigot Interchangeable Head and Plastic Handle



74PS-20

mm	N·m	L	
16 mm	4-20 N·m	206 mm	1 74PS-20

Mechanical Preset Free Hand Point Torque Click Wrench with Spigot Interchangeable Head



75PS-650

mm	N·m	L	
22 mm	130-650 N·m	800 mm	1 75PS-650

Handle Extension for 75 Series Torque Click Wrench



75EXT

700 mm	60 mm	1.600 kg	1	75EXT

TORQUE SCREWDRIVERS

Digital Torque and Angle Bluetooth® Screwdriver



TASMB14H

1/4 in	0.04-0.7 N·m	0.01 N·m	1	TASMB14H007
1/4 in	0.45-9 N·m	0.01 N·m	1	TASMB14H09

Accuracy: 20% to 100% of full scale

Digital Torque and Angle Screwdriver with Memory and USB



TASM14H

1/4 in	0.035-0.700 N·m	1	TASM14H007
1/4 in	0.45-9 N·m	1	TASM14H09

Electronic Torque and Angle Screwdriver



TAS14

1/4" in		0.04-0.7 N·m	1	TAS14H007
- in	1/4" in	0.04-0.7 N·m	1	TAS14S007
1/4" in		0.45-9 N·m	1	TAS14H09
	1/4" in	0.45-9 N·m	1	TAS14S09

Accuracy: 20% to 100% of full scale

Adjustable Torque Screwdriver with Window Scale



6973N-6978N

1/4 in	16-80 cNm	1 cNm	1	6973N
1/4 in	40-200 cNm	2 cNm	1	6976N
1/4 in	90-450 cNm	5 cNm	1	6978N

Adjustable Torque Mini Wrench with Fixed Screwdriver Bit



6852-5

1/4 in	1-5 N·m	0.1 N·m	1	6852-5



Adjustable Torque Mini Wrench Set with Fixed Screwdriver Bit



6852-5/S17

32 x 70 x 200 mm	0.29 kg	1	6852-5/S17

6852-5	
6700SM-4	
59S/PH0, 59S/PH1	
59S/PZ0, 59S/PZ1	
59S/H1.5	
59S/0.8-5.5, 59S/0.6-4.5	
59S/T6, 59S/T7, 59S/T8	

Adjustable Torque Screwdriver with Marked Scale in cN·m



TSS120

1/4 in	10-120 cN·m	1 cN·m	1	TSS120

Adjustable Torque Screwdriver with Marked Scale in N·m



TSS600

1/4 in	1-6 N·m	0.1 N·m	1	TSS600

Preset Torque Screwdriver with 1/4" Hex Bit Holder



6873N-6880N

7-70 cN·m	1/4 in	1/4 in	1	6876N
15-170 cN·m	1/4 in	1/4 in	1	6878N
45-450 cN·m	1/4 in	1/4 in	1	6880N

Preset Torque Mini Wrench with Fixed Screwdriver Bit



6852P-5

1/4" in	1-5 N·m	157 mm	1	6852P-5

Fixed Preset ERGO™ Torque Screwdriver. With TORX® and TORX Plus® blades



BE-6990

0.6 N·m	T6 IP6	1	BE-6990-IP6
0.9 N·m	T7 IP7	1	BE-6990-IP7
1.2 N·m	T8 IP8	1	BE-6990-IP8
1.4 N·m	T9 IP9	1	BE-6990-IP9
2 N·m	T10 IP10	1	BE-6990-IP10
3 N·m	T15 IP15	1	BE-6990-IP15

Fixed Preset ERGO™ Torque Screwdriver Set



BE-6990-IPSET

40 x 170 x 215 mm	0.755 kg	1	BE-6990-IPSET

BE-6990-IP7, BE-6990-IP8, BE-6990-IP9, BE-6990-IP15

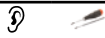

Torque Screwdriver Blades with TORX® Tip



BE-6990TX-KL



T6	1.70 mm	160 mm	10	BE-6990TX-T6-KL
T7	1.99 mm	160 mm	10	BE-6990TX-T7-KL
T8	2.31 mm	160 mm	10	BE-6990TX-T8-KL
T9	2.50 mm	170 mm	10	BE-6990TX-T9-KL
T10	2.74 mm	170 mm	10	BE-6990TX-T10KL
T15	3.27 mm	170 mm	10	BE-6990TX-T15KL

Torque Screwdriver Blades with TORX PLUS® Tip



BE-6990-IP-KL



IP6	1.50 mm	170 mm	10	BE-6990-IP6-KL
IP7	1.99 mm	170 mm	10	BE-6990-IP7-KL
IP8	2.31 mm	170 mm	10	BE-6990-IP8-KL
IP9	2.50 mm	170 mm	10	BE-6990-IP9-KL
IP10	2.74 mm	170 mm	10	BE-6990-IP10-KL
IP15	3.27 mm	170 mm	10	BE-6990-IP15-KL

Spare blade for TORX® head screws



BE-6990-IP20-KL

IP20	4.5 mm	90 mm	10	BE-6990-IP20-KL

Spare blade for TORX® head screws



BE-6990TX-T20KL

T20	4.5 mm	92 mm	10	BE-6990TX-T20KL

MULTIPLIERS

Hand Torque Multiplier with Offset and Straight Reaction Arms



89049TM-1000

1000 Nm - 3/4 in	5:1	200 Nm - 1/2 in	1	89049TM-1000



Hand Torque Multiplier with Offset and Straight Reaction Arms



8905-TM/9505-TM

1300 Nm - 3/4 in	5:1	260 Nm - 1/2 in	1	8905-TM
2700 Nm - 1 in	5:1	540 Nm - 3/4 in	1	9505-TM

Hand Torque Multiplier with Reaction Plate



9505

3400 Nm - 1 in	5.2:1	680 Nm - 3/4 in	1	9505-3400

Hand Torque Multiplier with Reaction Plate and Ratcheting Locking System



9525-9625

3400 Nm - 1 in	27:1	125 Nm - 1/2 in	1	9525-3400
9500 Nm - 1.1/2 in	27:1	380 Nm - 3/4 in	1	9625-9500

Hand Torque Multiplier with Straight Reaction Arm



95155B/9526B

3000 Nm - 1 in	15.5:1	193 Nm - 1/2 in	1	95155B-3000
4500 Nm - 1 in	27:1	166 Nm - 1/2 in	1	9526B-4500

Compact Hand Torque Multiplier with Offset Reaction Arm



89222CR/96255CR

1000 Nm - 3/4 in	22.2:1	45 Nm - 1/2 in	1	89222CR-1000
2000 Nm - 1 in	27:1	74 Nm - 1/2 in	1	9527CR-2000
4000 Nm - 1 in	25:1	160 Nm - 1/2 in	1	9525CR-4000
7000 Nm - 1.1/2 in	25.5:1	274 Nm - 1/2 in	1	96255CR-7000

TORQUE TESTERS

Multifunctional Testers for torque screwdrivers and wrenches



TEA003-TEA030

0.1-3.0 N·m	1/4 in	0.01 N·m	1	TEA003
0.5-10 N·m	1/4 in	0.01 N·m	1	TEA010
1.5-30 N·m	10 mm	0.1 N·m	1	TEA030A



Joint Simulators for Torque Testing Equipment



TJS

3 N·m	1/4 in	31 mm	1	TJS003
10 N·m	1/4 in	31 mm	1	TJS010
30 N·m	1/4 in	31 mm	1	TJS030

Multifunctional tester for torque wrenches



TEA065-TEA2100

mm		in			
3-65 N·m	- mm	3/8 in		1	TEA065
10-350 N·m	- mm	1/2 in		1	TEA350
50-1100 N·m	27 mm	3/4 in		1	TEA1100
200-2100 N·m	27 mm			1	TEA2100

TORQUE ANGLE ADAPTORS

Electronic Torque and Angle Meter



TAM

mm					
1/4 in	1,5-30 N·m	1	TAM1430		
3/8 in	6,8-135 N·m	1	TAM38135		
1/2 in	6,8-135 N·m	1	TAM12135		
1/2 in	10-200 N·m	1	TAM12200		
1/2 in	17-340 N·m	1	TAM12340		

Electronic Angle Meter



MAM

0-360°	56 mm	1	MAM50M		

Angle Meter with Magnet



7851-M/8951-M

		L			
1/2 in	0-360	490 mm		1	7851-M
3/4 in	0-360	490 mm		1	8951-M

Angle Meter with Clamp



7851-G

		L			
1/2 in	0-360	555 mm		1	7851-G

INSERT TOOLS

Round Ratchet Head with Rectangular Connector



9/14/24/27R

		mm		max			
1/4 in	9x12 mm	30 N·m		1	9R-1/4		
3/8 in	9x12 mm	135 N·m		1	9R-3/8		
1/2 in	9x12 mm	160 N·m		1	9R-1/2		
1/2 in	14x18 mm	340 N·m		1	14R-1/2		
3/4 in	14x18 mm	420 N·m		1	14R-3/4		
3/4 in	24x32 mm	1000 N·m		1	24R-3/4		
1 in	24x32 mm	1200 N·m		1	24R-1		
1 in	27x36 mm	2500 N·m		1	27R-1		



Push-Through Square Ratchet Head with Rectangular Connector



1/2 in	9x12 mm	160 N·m	1	9P-1/2
1/2 in	14x18 mm	340 N·m	1	14P-1/2

9/14/24/27T

1/4 in	9x12 mm	30 N·m	1	9T-1/4
3/8 in	9x12 mm	135 N·m	1	9T-3/8
1/2 in	9x12 mm	160 N·m	1	9T-1/2
1/2 in	14x18 mm	340 N·m	1	14T-1/2
3/4 in	14x18 mm	420 N·m	1	14T-3/4
3/4 in	24x32 mm	1000 N·m	1	24T-3/4
1 in	24x32 mm	1200 N·m	1	24T-1
1 in	27x36 mm	2500 N·m	1	27T-1

Pear Ratchet Head with Quick-Release and Rectangular Connector



Fixed Square Head with Rectangular Connector



9/14/24/27F

1/4 in	9x12 mm	30 N·m	1	9F-1/4
3/8 in	9x12 mm	135 N·m	1	9F-3/8
1/2 in	9x12 mm	160 N·m	1	9F-1/2
1/2 in	14x18 mm	340 N·m	1	14F-1/2
3/4 in	14x18 mm	420 N·m	1	14F-3/4
3/4 in	24x32 mm	1000 N·m	1	24F-3/4
1 in	24x32 mm	1200 N·m	1	24F-1
1 in	27x36 mm	2500 N·m	1	27F-1

9/14Q

1/4 in	9x12 mm	30 N·m	1	9Q-1/4
3/8 in	9x12 mm	135 N·m	1	9Q-3/8
1/2 in	9x12 mm	160 N·m	1	9Q-1/2
1/2 in	14x18 mm	340 N·m	1	14Q-1/2

Ratchet Head for Screwdriver Bits with Rectangular Connector



Pear Ratchet Head with Rectangular Connector



9/14P

1/4 in	9x12 mm	30 N·m	1	9P-1/4
3/8 in	9x12 mm	135 N·m	1	9P-3/8





9B





1/4 in	9x12 mm	1	9B-1/4
5/16 in	9x12 mm	1	9B-5/16

Open-End Metric Wrench with Rectangular Connector



9/14/24/277





				
mm	mm	N·m		
7 mm	9x12 mm	9 N·m	1	97-7
8 mm	9x12 mm	13 N·m	1	97-8
9 mm	9x12 mm	18 N·m	1	97-9
10 mm	9x12 mm	24 N·m	1	97-10
11 mm	9x12 mm	32 N·m	1	97-11
12 mm	9x12 mm	41 N·m	1	97-12
13 mm	9x12 mm	51 N·m	1	97-13
14 mm	9x12 mm	63 N·m	1	97-14
15 mm	9x12 mm	77 N·m	1	97-15
16 mm	9x12 mm	92 N·m	1	97-16
17 mm	9x12 mm	109 N·m	1	97-17
18 mm	9x12 mm	125 N·m	1	97-18
19 mm	9x12 mm	145 N·m	1	97-19
21 mm	9x12 mm	160 N·m	1	97-21
22 mm	9x12 mm	160 N·m	1	97-22
24 mm	9x12 mm	160 N·m	1	97-24
27 mm	9x12 mm	160 N·m	1	97-27
30 mm	9x12 mm	160 N·m	1	97-30
32 mm	9x12 mm	160 N·m	1	97-32
13 mm	14x18 mm	51 N·m	1	147-13
14 mm	14x18 mm	63 N·m	1	147-14
15 mm	14x18 mm	77 N·m	1	147-15
16 mm	14x18 mm	92 N·m	1	147-16
17 mm	14x18 mm	109 N·m	1	147-17
18 mm	14x18 mm	125 N·m	1	147-18
19 mm	14x18 mm	145 N·m	1	147-19
21 mm	14x18 mm	190 N·m	1	147-21
22 mm	14x18 mm	220 N·m	1	147-22
24 mm	14x18 mm	280 N·m	1	147-24
25 mm	14x18 mm	320 N·m	1	147-25
27 mm	14x18 mm	360 N·m	1	147-27
30 mm	14x18 mm	360 N·m	1	147-30
32 mm	14x18 mm	360 N·m	1	147-32
33 mm	14x18 mm	360 N·m	1	147-33
34 mm	14x18 mm	360 N·m	1	147-34
35 mm	14x18 mm	360 N·m	1	147-35
36 mm	14x18 mm	360 N·m	1	147-36
37 mm	14x18 mm	360 N·m	1	147-37
38 mm	14x18 mm	360 N·m	1	147-38
39 mm	14x18 mm	360 N·m	1	147-39
41 mm	14x18 mm	360 N·m	1	147-41
45 mm	14x18 mm	360 N·m	1	147-45
46 mm	14x18 mm	360 N·m	1	147-46
50 mm	14x18 mm	360 N·m	1	147-50
55 mm	14x18 mm	360 N·m	1	147-55
60 mm	14x18 mm	360 N·m	1	147-60
65 mm	14x18 mm	360 N·m	1	147-65
68 mm	14x18 mm	360 N·m	1	147-68
70 mm	14x18 mm	360 N·m	1	147-70
75 mm	14x18 mm	360 N·m	1	147-75
90 mm	14x18 mm	360 N·m	1	147-90
24 mm	24x32 mm	1200 N·m	1	247-24
27 mm	24x32 mm	1200 N·m	1	247-27

				
mm	mm	N·m		
30 mm	24x32 mm	1200 N·m	1	247-30
32 mm	24x32 mm	1200 N·m	1	247-32
34 mm	24x32 mm	1200 N·m	1	247-34
36 mm	24x32 mm	1200 N·m	1	247-36
41 mm	24x32 mm	1200 N·m	1	247-41
46 mm	24x32 mm	1200 N·m	1	247-46
50 mm	24x32 mm	1200 N·m	1	247-50
55 mm	24x32 mm	1200 N·m	1	247-55
60 mm	24x32 mm	1200 N·m	1	247-60
30 mm	27x36 mm	3000 N·m	1	277-30
32 mm	27x36 mm	3000 N·m	1	277-32
34 mm	27x36 mm	3000 N·m	1	277-34
36 mm	27x36 mm	3000 N·m	1	277-36
41 mm	27x36 mm	3000 N·m	1	277-41
46 mm	27x36 mm	3000 N·m	1	277-46
50 mm	27x36 mm	3000 N·m	1	277-50
55 mm	27x36 mm	3000 N·m	1	277-55
60 mm	27x36 mm	3000 N·m	1	277-60

Open-End Imperial Wrench with Rectangular Connector



9/14/24/277"





				
in	mm	N·m		
1/4 in	9x12 mm	6 N·m	1	97-1/4
5/16 in	9x12 mm	13 N·m	1	97-5/16
3/8 in	9x12 mm	24 N·m	1	97-3/8
7/16 in	9x12 mm	32 N·m	1	97-7/16
1/2 in	9x12 mm	51 N·m	1	97-1/2
17/32 in	9x12 mm	63 N·m	1	97-17/32
9/16 in	9x12 mm	77 N·m	1	97-9/16
5/8 in	9x12 mm	92 N·m	1	97-5/8
11/16 in	9x12 mm	125 N·m	1	97-11/16
3/4 in	9x12 mm	145 N·m	1	97-3/4
13/16 in	9x12 mm	160 N·m	1	97-13/16
7/8 in	9x12 mm	160 N·m	1	97-7/8
15/16 in	9x12 mm	160 N·m	1	97-15/16
1 in	9x12 mm	160 N·m	1	97-1
7/16 in	14x18 mm	32 N·m	1	147-7/16
1/2 in	14x18 mm	51 N·m	1	147-1/2
9/16 in	14x18 mm	77 N·m	1	147-9/16
5/8 in	14x18 mm	92 N·m	1	147-5/8
11/16 in	14x18 mm	109 N·m	1	147-11/16
3/4 in	14x18 mm	145 N·m	1	147-3/4
13/16 in	14x18 mm	190 N·m	1	147-13/16
7/8 in	14x18 mm	220 N·m	1	147-7/8
15/16 in	14x18 mm	280 N·m	1	147-15/16
1 in	14x18 mm	360 N·m	1	147-1
1 1/8 in	14x18 mm	360 N·m	1	147-1.1/8
1 1/4 in	14x18 mm	360 N·m	1	147-1.1/4



Ring End Metric Wrench with Rectangular Connector







9/14/24/278

				
mm	mm	N·m		
7 mm	9x12 mm	25 N·m	1	98-7
8 mm	9x12 mm	34 N·m	1	98-8
9 mm	9x12 mm	45 N·m	1	98-9
10 mm	9x12 mm	58 N·m	1	98-10
11 mm	9x12 mm	47 N·m	1	98-11
12 mm	9x12 mm	89 N·m	1	98-12
13 mm	9x12 mm	105 N·m	1	98-13
14 mm	9x12 mm	125 N·m	1	98-14
15 mm	9x12 mm	145 N·m	1	98-15
16 mm	9x12 mm	160 N·m	1	98-16
17 mm	9x12 mm	160 N·m	1	98-17
18 mm	9x12 mm	160 N·m	1	98-18
19 mm	9x12 mm	160 N·m	1	98-19
21 mm	9x12 mm	160 N·m	1	98-21
22 mm	9x12 mm	160 N·m	1	98-22
13 mm	14x18 mm	105 N·m	1	148-13
14 mm	14x18 mm	125 N·m	1	148-14
15 mm	14x18 mm	150 N·m	1	148-15
16 mm	14x18 mm	175 N·m	1	148-16
17 mm	14x18 mm	200 N·m	1	148-17
18 mm	14x18 mm	230 N·m	1	148-18
19 mm	14x18 mm	260 N·m	1	148-19
21 mm	14x18 mm	330 N·m	1	148-21
22 mm	14x18 mm	360 N·m	1	148-22
24 mm	14x18 mm	360 N·m	1	148-24
27 mm	14x18 mm	360 N·m	1	148-27
28 mm	14x18 mm	360 N·m	1	148-28
30 mm	14x18 mm	360 N·m	1	148-30
32 mm	14x18 mm	360 N·m	1	148-32
34 mm	14x18 mm	360 N·m	1	148-34
36 mm	14x18 mm	360 N·m	1	148-36
41 mm	14x18 mm	360 N·m	1	148-41
24 mm	24x32 mm	1200 N·m	1	248-24
27 mm	24x32 mm	1200 N·m	1	248-27
30 mm	24x32 mm	1200 N·m	1	248-30
32 mm	24x32 mm	1200 N·m	1	248-32
34 mm	24x32 mm	1200 N·m	1	248-34
36 mm	24x32 mm	1200 N·m	1	248-36
41 mm	24x32 mm	1200 N·m	1	248-41
46 mm	24x32 mm	1200 N·m	1	248-46
50 mm	24x32 mm	1200 N·m	1	248-50
55 mm	24x32 mm	1200 N·m	1	248-55
60 mm	24x32 mm	1200 N·m	1	248-60
30 mm	27x36 mm	3000 N·m	1	278-30
32 mm	27x36 mm	1240 N·m	1	278-32
34 mm	27x36 mm	3000 N·m	1	278-34
36 mm	27x36 mm	3000 N·m	1	278-36
41 mm	27x36 mm	3000 N·m	1	278-41
46 mm	27x36 mm	3000 N·m	1	278-46
50 mm	27x36 mm	3000 N·m	1	278-50
55 mm	27x36 mm	3000 N·m	1	278-55
60 mm	27x36 mm	3000 N·m	1	278-60

Ring End Imperial Wrench with Rectangular Connector







9/14/24/278"

				
in	mm	N·m		
1/4 in	9x12 mm	25 N·m	1	98-1/4
5/16 in	9x12 mm	34 N·m	1	98-5/16
3/8 in	9x12 mm	58 N·m	1	98-3/8
7/16 in	9x12 mm	72 N·m	1	98-7/16
1/2 in	9x12 mm	105 N·m	1	98-1/2
9/16 in	9x12 mm	125 N·m	1	98-9/16
5/8 in	9x12 mm	160 N·m	1	98-5/8
11/16 in	9x12 mm	160 N·m	1	98-11/16
3/4 in	9x12 mm	57 N·m	1	98-3/4
13/16 in	14x18 mm	330 N·m	1	148-13/16
13/16 in	9x12 mm	160 N·m	1	98-13/16
7/8 in	9x12 mm	160 N·m	1	98-7/8
1/2 in	14x18 mm	105 N·m	1	148-1/2
9/16 in	14x18 mm	150 N·m	1	148-9/16
5/8 in	14x18 mm	175 N·m	1	148-5/8
11/16 in	14x18 mm	230 N·m	1	148-11/16
3/4 in	14x18 mm	260 N·m	1	148-3/4
15/16 in	14x18 mm	360 N·m	1	148-15/16
7/8 in	14x18 mm	360 N·m	1	148-7/8
1 in	14x18 mm	360 N·m	1	148-1

Flare Nut End Wrench with Rectangular Connector



99 in

				
in	mm	N·m		
3/8 in	9x12 mm	9 N·m	1	99-3/8
7/16 in	9x12 mm	16 N·m	1	99-7/16
1/2 in	9x12 mm	28 N·m	1	99-1/2
9/16 in	9x12 mm	31 N·m	1	99-9/16
5/8 in	9x12 mm	46 N·m	1	99-5/8
11/16 in	9x12 mm	65 N·m	1	99-11/16
3/4 in	9x12 mm	74 N·m	1	99-3/4

Flare Nut End Wrench with Rectangular Connector



99

mm	mm	max		
10 mm	9x12 mm	14 N·m	1	99-10
11 mm	9x12 mm	19 N·m	1	99-11
12 mm	9x12 mm	24 N·m	1	99-12
13 mm	9x12 mm	30 N·m	1	99-13
14 mm	9x12 mm	37 N·m	1	99-14
16 mm	9x12 mm	46 N·m	1	99-16
17 mm	9x12 mm	55 N·m	1	99-17
18 mm	9x12 mm	65 N·m	1	99-18
19 mm	9x12 mm	74 N·m	1	99-19
21 mm	9x12 mm	87 N·m	1	99-21
22 mm	9x12 mm	96 N·m	1	99-22
24 mm	9x12 mm	96 N·m	1	99-24

Increasing and Reducing Rectangular Connector Adaptors



9/14/24/27A

mm	mm	max		
9x12 mm	14x18 mm	160 N·m	1	9A-14
14x18 mm	9x12 mm	160 N·m	1	14A-9
14x18 mm	24x32 mm	360 N·m	1	14A-32
24x32 mm	14x18 mm	360 N·m	1	24A-14
24x32 mm	27x36 mm	1200 N·m	1	24A-27
27x36 mm	24x32 mm	1200 N·m	1	27A-24

Weld-On Adaptor with Rectangular Connector



9/14/24W

mm	L		
9x12 mm	23.8 mm	1	9W
14x18 mm	38 mm	1	14W
24x32 mm	65 mm	1	24W

Round Ratchet Head with Spigot Connector



16R/22R

	mm	max		
1/4" in	16 mm	20 N·m	1	16R-1/4
3/8" in	16 mm	160 N·m	1	16R-3/8
1/2" in	16 mm	420 N·m	1	16R-1/2
3/4" in	22 mm	1200 N·m	1	22R-3/4

Fixed Square Head with Spigot Connector



16F/22F





	mm	max		
1/4" in	16 mm	20 N·m	1	16F-1/4
3/8" in	16 mm	160 N·m	1	16F-3/8
1/2" in	16 mm	420 N·m	1	16F-1/2
3/4" in	22 mm	1200 N·m	1	22F-3/4



Open End Metric Wrench with Spigot Connector







167/227

				
mm	mm	mm		
7 mm	16 mm	9 N·m	1	167-7
8 mm	16 mm	13 N·m	1	167-8
9 mm	16 mm	18 N·m	1	167-9
10 mm	16 mm	24 N·m	1	167-10
11 mm	16 mm	32 N·m	1	167-11
12 mm	16 mm	41 N·m	1	167-12
13 mm	16 mm	51 N·m	1	167-13
14 mm	16 mm	63 N·m	1	167-14
15 mm	16 mm	77 N·m	1	167-15
16 mm	16 mm	92 N·m	1	167-16
17 mm	16 mm	109 N·m	1	167-17
18 mm	16 mm	125 N·m	1	167-18
19 mm	16 mm	145 N·m	1	167-19
20 mm	16 mm	160 N·m	1	167-20
21 mm	16 mm	190 N·m	1	167-21
22 mm	16 mm	220 N·m	1	167-22
23 mm	16 mm	250 N·m	1	167-23
24 mm	16 mm	280 N·m	1	167-24
25 mm	16 mm	320 N·m	1	167-25
26 mm	16 mm	360 N·m	1	167-26
27 mm	16 mm	360 N·m	1	167-27
28 mm	16 mm	360 N·m	1	167-28
30 mm	16 mm	360 N·m	1	167-30
32 mm	16 mm	360 N·m	1	167-32
36 mm	16 mm	360 N·m	1	167-36
22 mm	22 mm	1200 N·m	1	227-22
24 mm	22 mm	1200 N·m	1	227-24
27 mm	22 mm	1200 N·m	1	227-27
30 mm	22 mm	1200 N·m	1	227-30
32 mm	22 mm	1200 N·m	1	227-32
34 mm	22 mm	1200 N·m	1	227-34
36 mm	22 mm	1200 N·m	1	227-36
41 mm	22 mm	1200 N·m	1	227-41
46 mm	22 mm	1200 N·m	1	227-46

Open-End Imperial Wrench with Spigot Connector







167





				
	mm	mm		
5/16 in	16 mm	34 N·m	1	167-5/16
3/8 in	16 mm	45 N·m	1	167-3/8
7/16 in	16 mm	72 N·m	1	167-7/16
1/2 in	16 mm	51 N·m	1	167-1/2
9/16 in	16 mm	77 N·m	1	167-9/16
5/8 in	16 mm	92 N·m	1	167-5/8
11/16 in	16 mm	109 N·m	1	167-11/16
3/4 in	16 mm	145 N·m	1	167-3/4
13/16 in	16 mm	190 N·m	1	167-13/16
7/8 in	16 mm	220 N·m	1	167-7/8
15/16 in	16 mm	280 N·m	1	167-15/16
1 in	16 mm	360 N·m	1	167-1
1.1/16 in	16 mm	360 N·m	1	167-1.1/16
1.1/8 in	16 mm	360 N·m	1	167-1.1/8
1.3/16 in	16 mm	360 N·m	1	167-1.3/16
1.1/4 in	16 mm	360 N·m	1	167-1.1/4

Ring End Metric Wrench with Spigot Connector



168/228





				
	mm	mm		
7 mm	16 mm	25 N·m	1	168-7
8 mm	16 mm	34 N·m	1	168-8
9 mm	16 mm	45 N·m	1	168-9
10 mm	16 mm	58 N·m	1	168-10
11 mm	16 mm	72 N·m	1	168-11

				
mm	mm	N·m		
12 mm	16 mm	89 N·m	1	168-12
13 mm	16 mm	105 N·m	1	168-13
14 mm	16 mm	125 N·m	1	168-14
15 mm	16 mm	150 N·m	1	168-15
16 mm	16 mm	175 N·m	1	168-16
17 mm	16 mm	200 N·m	1	168-17
18 mm	16 mm	230 N·m	1	168-18
19 mm	16 mm	260 N·m	1	168-19
20 mm	16 mm	290 N·m	1	168-20
21 mm	16 mm	330 N·m	1	168-21
22 mm	16 mm	360 N·m	1	168-22
23 mm	16 mm	360 N·m	1	168-23
24 mm	16 mm	360 N·m	1	168-24
26 mm	16 mm	360 N·m	1	168-26
27 mm	16 mm	360 N·m	1	168-27
22 mm	22 mm	1200 N·m	1	228-22
24 mm	22 mm	1200 N·m	1	228-24
27 mm	22 mm	1200 N·m	1	228-27
30 mm	22 mm	1200 N·m	1	228-30
32 mm	22 mm	1200 N·m	1	228-32
34 mm	22 mm	1200 N·m	1	228-34
36 mm	22 mm	1200 N·m	1	228-36
41 mm	22 mm	1200 N·m	1	228-41
46 mm	22 mm	1200 N·m	1	228-46

Ring End Imperial Wrench with Spigot Connector







168

				
	mm	N·m		
5/16 in	16 mm	34 N·m	1	168-5/16
3/8 in	16 mm	58 N·m	1	168-3/8
7/16 in	16 mm	89 N·m	1	168-7/16
1/2 in	16 mm	105 N·m	1	168-1/2
9/16 in	16 mm	125 N·m	1	168-9/16
5/8 in	16 mm	125 N·m	1	168-5/8
11/16 in	16 mm	125 N·m	1	168-11/16
3/4 in	16 mm	260 N·m	1	168-3/4
13/16 in	16 mm	290 N·m	1	168-13/16
7/8 in	16 mm	360 N·m	1	168-7/8
15/16 in	16 mm	360 N·m	1	168-15/16
1 in	16 mm	360 N·m	1	168-1
1.1/16 in	16 mm	360 N·m	1	168-1.1/16
1.3/16 in	16 mm	360 N·m	1	168-1.3/16

Flare Nut End Metric Wrench with Spigot Connector



169

				
mm	mm	N·m		
7 mm	16 mm	6 N·m	1	169-7
8 mm	16 mm	8 N·m	1	169-8
9 mm	16 mm	10 N·m	1	169-9
10 mm	16 mm	12 N·m	1	169-10
11 mm	16 mm	16 N·m	1	169-11
12 mm	16 mm	16 N·m	1	169-12
13 mm	16 mm	28 N·m	1	169-13
14 mm	16 mm	31 N·m	1	169-14
15 mm	16 mm	38 N·m	1	169-15
16 mm	16 mm	46 N·m	1	169-16
17 mm	16 mm	53 N·m	1	169-17
18 mm	16 mm	65 N·m	1	169-18
19 mm	16 mm	74 N·m	1	169-19
20 mm	16 mm	86 N·m	1	169-20
21 mm	16 mm	100 N·m	1	169-21
22 mm	16 mm	115 N·m	1	169-22
23 mm	16 mm	125 N·m	1	169-23
24 mm	16 mm	145 N·m	1	169-24
27 mm	16 mm	160 N·m	1	169-27

EMPTY SET CASES FOR TORQUE TOOLS

Double Wall Shock Absorbing Empty Cases for Torque Tools



4750BMCT

		
kg		
0.95 kg	1	4750BMCT1







Power Tool Accessories



HOLESAWS

Sandflex® Bi-Metal Holesaws for Metal/
Wood Boards 14 mm-210 mm



3830

Size (mm)	Quantity	Model
14 mm	1	3830-14-C
16 mm	1	3830-16-C
17 mm	1	3830-17-C
19 mm	1	3830-19-C
20 mm	1	3830-20-C
21 mm	1	3830-21-C
22 mm	1	3830-22-C
24 mm	1	3830-24-C
25 mm	1	3830-25-C
27 mm	1	3830-27-C
29 mm	1	3830-29-C
30 mm	1	3830-30-C
32 mm	1	3830-32-C
33 mm	1	3830-33-C
35 mm	1	3830-35-C
37 mm	1	3830-37-C
38 mm	1	3830-38-C
40 mm	1	3830-40-C
41 mm	1	3830-41-C
43 mm	1	3830-43-C
44 mm	1	3830-44-C
46 mm	1	3830-46-C
48 mm	1	3830-48-C
50 mm	1	3830-50-C
51 mm	1	3830-51-C
52 mm	1	3830-52-C
54 mm	1	3830-54-C
55 mm	1	3830-55-C
56 mm	1	3830-56-C
57 mm	1	3830-57-C
59 mm	1	3830-59-C
60 mm	1	3830-60-C
64 mm	1	3830-64-C
65 mm	1	3830-65-C
67 mm	1	3830-67-C
68 mm	1	3830-68-C
70 mm	1	3830-70-C
73 mm	1	3830-73-C
76 mm	1	3830-76-C
79 mm	1	3830-79-C
83 mm	1	3830-83-C
86 mm	1	3830-86-C
89 mm	1	3830-89-C
92 mm	1	3830-92-C
95 mm	1	3830-95-C
98 mm	1	3830-98-C
102 mm	1	3830-102-C
105 mm	1	3830-105-C
108 mm	1	3830-108-C

Size (mm)	Quantity	Model
111 mm	1	3830-111-C
114 mm	1	3830-114-C
121 mm	1	3830-121-C
127 mm	1	3830-127-C
133 mm	1	3830-133-C
140 mm	1	3830-140-C
146 mm	1	3830-146-C
152 mm	1	3830-152-C
14 mm	6	3830-14-VIP
16 mm	6	3830-16-VIP
17 mm	6	3830-17-VIP
19 mm	6	3830-19-VIP
20 mm	6	3830-20-VIP
21 mm	6	3830-21-VIP
22 mm	6	3830-22-VIP
24 mm	6	3830-24-VIP
25 mm	6	3830-25-VIP
27 mm	6	3830-27-VIP
29 mm	6	3830-29-VIP
30 mm	6	3830-30-VIP
32 mm	6	3830-32-VIP
33 mm	6	3830-33-VIP
35 mm	6	3830-35-VIP
37 mm	6	3830-37-VIP
38 mm	6	3830-38-VIP
40 mm	6	3830-40-VIP
41 mm	6	3830-41-VIP
43 mm	6	3830-43-VIP
44 mm	6	3830-44-VIP
46 mm	6	3830-46-VIP
48 mm	6	3830-48-VIP
50 mm	6	3830-50-VIP
51 mm	6	3830-51-VIP
52 mm	4	3830-52-VIP
54 mm	4	3830-54-VIP
55 mm	4	3830-55-VIP
56 mm	4	3830-56-VIP
57 mm	4	3830-57-VIP
59 mm	4	3830-59-VIP
60 mm	4	3830-60-VIP
62 mm	4	3830-62-VIP
64 mm	4	3830-64-VIP
65 mm	4	3830-65-VIP
67 mm	4	3830-67-VIP
68 mm	4	3830-68-VIP
70 mm	4	3830-70-VIP
73 mm	4	3830-73-VIP
76 mm	4	3830-76-VIP
79 mm	4	3830-79-VIP
83 mm	4	3830-83-VIP
86 mm	4	3830-86-VIP
89 mm	4	3830-89-VIP
92 mm	4	3830-92-VIP
95 mm	4	3830-95-VIP
98 mm	4	3830-98-VIP
102 mm	4	3830-102-VIP
105 mm	4	3830-105-VIP
108 mm	4	3830-108-VIP
111 mm	4	3830-111-VIP
114 mm	4	3830-114-VIP
121 mm	1	3830-121-VIP
127 mm	1	3830-127-VIP
133 mm	1	3830-133-VIP
140 mm	1	3830-140-VIP
146 mm	1	3830-146-VIP
152 mm	1	3830-152-VIP
168 mm	1	3830-168
177 mm	1	3830-177-HIGH
210 mm	1	3830-210

Sandflex® Bi-Metal Holesaws, 4 pack



3830-4P

Quantity	Size (mm)	Quantity	Model
4	19 mm	1	3830-19-4P
4	20 mm	1	3830-20-4P
4	22 mm	1	3830-22-4P
4	25 mm	1	3830-25-4P
4	27 mm	1	3830-27-4P
4	29 mm	1	3830-29-4P
4	30 mm	1	3830-30-4P
4	32 mm	1	3830-32-4P
4	35 mm	1	3830-35-4P

Sandflex® Bi-Metal Holesaw Set 20x4 mm + 25x4 mm - 11 pcs



3834-CP-20/25

Weight (g)	Quantity	Model
600 g	1	3834-CP-20/25

3830-20-Cx 4, 3830-25-Cx 4

3834-ARBR-930

3834-DRLx 2



Sandflex® Bi-Metal Holesaw Set 20–76 mm - 10 pcs



3834-PROMO-82

g 1 3834-PROMO-82

1188 g

3830-20-C, 3830-25-C, 3830-30-C, 3830-35-C, 3830-44-C, 3830-51-C, 3830-64-C, 3830-76-C

3834-ARBR-930

3834-ARBR-11152QC

Sandflex® Bi-Metal Holesaw Set 19–76 mm - 14 pcs



3834-PROMO-122-76

g 1 3834-PROMO-122-76

1441 g

3830-19-C, 3830-20-C, 3830-22-C, 3830-25-C, 3830-27-C, 3830-32-C, 3830-35-C, 3830-38-C, 3830-40-C, 3830-51-C, 3830-64-C, 3830-76-C

3834-ARBR-930

3834-ARBR-9100

Sandflex® Bi-Metal Holesaw Set 51 mm-111 mm - 6 Pcs



3834-42

g 1 3834-SET-42

2025 g

3830-51-VIP, 3830-76-VIP, 3830-86-VIP, 3830-111-VIP

3834-ARBR-9100

3834-ES

Sandflex® Bi-Metal Holesaw Set 16–44 mm - 14 pcs



3834-PROMO-122

g 1 3834-PROMO-122

1100 g

3830-16-C, 3830-20-Cx 2, 3830-22-C, 3830-25-Cx 2, 3830-29-C, 3830-32-C, 3830-35-Cx 2, 3830-38-C, 3830-44-C

3834-ARBR-930

3834-ARBR-11152QC

Sandflex® Bi-Metal Holesaw Set 35–83 mm - 9 pcs



3834-SET-72-35/83

g 1 3834-SET-72-35/83

1613 g

3830-35-C, 3830-40-C, 3830-44-C, 3830-51-C, 3830-57-C, 3830-68-C, 3830-83-C

3834-ARBR-9100

3834-DRL

Sandflex® Bi-Metal Holesaw Set 19 mm-79 mm - 13 Pcs



3834-53

g 1 3834-SET-53

2370 g

3830-19-VIP, 3830-22-VIP, 3830-25-VIP, 3830-29-VIP, 3830-30-VIP, 3830-35-VIP, 3830-37-VIP, 3830-41-VIP, 3830-52-VIP, 3830-60-VIP, 3830-79-VIP

3834-ARBR-930

3834-ARBR-9100



Sandflex® Bi-Metal Holesaw Set 51 mm-114 mm - 7 Pcs



3834-61



3145 g



1 3834-SET-61

- 3830-44-VIP, 3830-51-VIP, 3830-57-VIP, 3830-73-VIP, 3830-86-VIP, 3830-114-VIP
- 3834-ARBR-9100

Sandflex® Bi-Metal Holesaw Set 19 mm-48 mm - 8 Pcs



3834-62



1050 g



1 3834-SET-62

- 3830-19-VIP, 3830-21-VIP, 3830-22-VIP, 3830-29-VIP, 3830-38-VIP, 3830-48-VIP
- 3834-ARBR-930
- 3834-ARBR-9100

Sandflex® Bi-Metal Holesaw Set for Metal/Wood Boards 16 mm-50 mm - 8 Pcs



3834-62-16/50



1065 g



1 3834-SET-62-16/50

- 3830-16-VIP, 3830-20-VIP, 3830-25-VIP, 3830-32-VIP, 3830-40-VIP, 3830-50-VIP

- 3834-ARBR-9100
- 3834-ARBR-930

Sandflex® Bi-Metal Holesaw Set for Metal/Wood Boards 16 mm-51 mm - 9 Pcs



3834-65-16/51



1465 g



1 3834-SET-65-16/51

- 3830-16-VIP, 3830-20-VIP, 3830-25-VIP, 3830-32-VIP, 3830-40-VIP, 3830-51-VIP

- 3834-ARBR-1130
- 3834-ARBR-11152
- 3834-DRL

Sandflex® Bi-Metal Holesaw Set for Metal/Wood Boards 22 mm-64 mm - 9 Pcs



3834-65-22/64



1625 g



1 3834-SET-65-22/64

- 3830-22-VIP, 3830-29-VIP, 3830-35-VIP, 3830-44-VIP, 3830-51-VIP, 3830-64-VIP

- 3834-ARBR-1130
- 3834-ARBR-11152
- 3834-DRL

Sandflex® Bi-Metal Holesaw Set 19 mm-64 mm - 9 Pcs



3834-72



1080 g

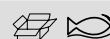

1 3834-SET-72

- 3830-19-VIP, 3830-22-VIP, 3830-29-VIP, 3830-35-VIP, 3830-44-VIP, 3830-51-VIP, 3830-64-VIP

- 3834-ARBR-930
- 3834-ARBR-9100

Sandflex® Bi-Metal Holesaw Set 16 mm-22 mm - 9 Pcs



3834-73

g 2080 g 1 3834-SET-73

- 3830-16-VIP, 3830-22-VIP, 3830-51-VIP, 3830-57-VIP, 3830-73-VIP, 3830-76-VIP, 3830-92-VIP
- 3834-ARBR-930
- 3834-ARBR-9100

Sandflex® Bi-Metal Holesaw Set 22 mm-68 mm - 10 Pcs



3834-73-22/68

g 2170 g 1 3834-SET-73-22/68

- 3830-22-VIP, 3830-29-VIP, 3830-35-VIP, 3830-44-VIP, 3830-51-VIP, 3830-64-VIP, 3830-68-VIP
- 3834-ARBR-1130
- 3834-ARBR-11152
- 3834-DRL

Sandflex® Bi-Metal Holesaw Set 16 mm-86 mm - 13 Pcs



3834-SET-77

g 3325 g 1 3834-SET-77

- 3830-16-VIP, 3830-20-VIP, 3830-25-VIP, 3830-32-VIP, 3830-41-VIP, 3830-51-VIP, 3830-73-VIP, 3830-76-VIP, 3830-83-VIP, 3830-86-VIP
- 3834-ARBR-930
- 3834-ARBR-9100
- 3834-DRL

Sandflex® Bi-Metal Holesaw Set 25-114 mm - 12 pcs



3834-SET-84-ES

g 3600 g 1 3834-SET-84-ES

- 3830-25-C, 3830-30-C, 3830-35-C, 3830-51-C, 3830-54-C, 3830-76-C, 3830-92-C, 3830-114-C
- 3834-ARBR-930ESM, 3834-ARBR-9100ESM
- 3834-DRL-HSS-ES
- 3834-UPSIZE

Sandflex® Bi-Metal Holesaw Set 25 mm-114 mm - 12 Pcs



3834-86

g 2540 g 1 3834-SET-86

- 3830-25-VIP, 3830-32-VIP, 3830-35-VIP, 3830-51-VIP, 3830-54-VIP, 3830-76-VIP, 3830-92-VIP, 3830-114-VIP
- 3834-ARBR-1130
- 3834-ARBR-11152
- 3834-DRLx 2
- 3834-ADP

Sandflex® Bi-Metal Holesaw Set 19 mm-65 mm - 12 Pcs



3834-87

g 1925 g 1 3834-SET-87

- 3830-19-VIP, 3830-22-VIP, 3830-29-VIP, 3830-38-VIP, 3830-43-VIP, 3830-48-VIP, 3830-52-VIP, 3830-65-VIP
- 3834-ARBR-930
- 3834-ARBR-9100
- 3834-DRL
- 3834-ES



Sandflex® Bi-Metal Holesaw Set for Metal/
Wood Boards 16 mm-83 mm - 11 Pcs



3834-92



1440 g



1 3834-SET-92

3830-16-VIP, 3830-22-VIP, 3830-25-VIP, 3830-29-VIP, 3830-32-VIP, 3830-41-VIP, 3830-51-VIP, 3830-73-VIP, 3830-83-VIP

3834-ARBR-930

3834-ARBR-9100

Sandflex® Bi-Metal Holesaw Set for Metal/
Wood Boards 16 mm-67 mm - 11 Pcs



3834-94



1815 g



1 3834-SET-94

3830-16-VIP, 3830-19-VIP, 3830-22-VIP, 3830-25-VIP, 3830-30-VIP, 3830-35-VIP, 3830-41-VIP, 3830-51-VIP, 3830-67-VIP

3834-ARBR-1130

3834-ARBR-11152

Sandflex® Bi-Metal Holesaw Set 16 mm-67
mm - 11 Pcs



3834-103



2015 g



1 3834-SET-103

3830-16-VIP, 3830-19-VIP, 3830-24-VIP, 3830-29-VIP, 3830-38-VIP, 3830-44-VIP, 3830-57-VIP, 3830-67-VIP

3834-ARBR-1130

3834-ARBR-11152

3834-DRL

Sandflex® Bi-Metal Holesaw Set 16-83
mm - 12 pcs



3834-93



2360 g



1 3834-SET-93

3830-16-VIP, 3830-20-VIP, 3830-25-VIP, 3830-32-VIP, 3830-40-VIP, 3830-51-VIP, 3830-67-VIP, 3830-76-VIP, 3830-83-VIP

3834-ARBR-930

3834-ARBR-9100QC

3834-DRL

Sandflex® Bi-Metal Holesaw Set for Metal/
Wood Boards 16 mm-64 mm - 12 Pcs



3834-95



1350 g



1 3834-SET-95

3830-16-VIP, 3830-19-VIP, 3830-22-VIP, 3830-29-VIP, 3830-35-VIP, 3830-44-VIP, 3830-52-VIP, 3830-57-VIP, 3830-64-VIP

3834-ARBR-1130

3834-ARBR-11152

3834-DRL

Sandflex® Bi-Metal Holesaw Set 16 mm-83
mm - 18 Pcs



3834-SET-152



3770 g



1 3834-SET-152

3830-16-VIP, 3830-19-VIP, 3830-22-VIP, 3830-25-VIP, 3830-32-VIP, 3830-35-VIP, 3830-44-VIP, 3830-51-VIP, 3830-57-VIP, 3830-60-VIP, 3830-65-VIP, 3830-68-VIP, 3830-73-VIP, 3830-76-VIP, 3830-83-VIP

3834-ARBR-930

3834-ARBR-9100

3834-DRLx 2

Superior™ Multi Construction Holesaws for Wood and Brick 19 mm-225 mm



3833

19 mm	1	3833-19-C	
20 mm	1	3833-20-C	
22 mm	1	3833-22-C	
25 mm	1	3833-25-C	
27 mm	1	3833-27-C	
29 mm	1	3833-29-C	
30 mm	1	3833-30-C	
32 mm	1	3833-32-C	
35 mm	1	3833-35-C	
38 mm	1	3833-38-C	
40 mm	1	3833-40-C	
41 mm	1	3833-41-C	
44 mm	1	3833-44-C	
48 mm	1	3833-48-C	
51 mm	1	3833-51-C	
54 mm	1	3833-54-C	
56 mm	1	3833-56-C	
57 mm	1	3833-57-C	
60 mm	1	3833-60-C	
62 mm	1	3833-62-C	
64 mm	1	3833-64-C	
65 mm	1	3833-65-C	
67 mm	1	3833-67-C	
68 mm	1	3833-68-C	
70 mm	1	3833-70-C	
71 mm	1	3833-71-C	
73 mm	1	3833-73-C	
74 mm	1	3833-74-C	
76 mm	1	3833-76-C	
77 mm	1	3833-77-C	
78 mm	1	3833-78-C	
79 mm	1	3833-79-C	
83 mm	1	3833-83-C	
86 mm	1	3833-86-C	
89 mm	1	3833-89-C	
92 mm	1	3833-92-C	
95 mm	1	3833-95-C	
98 mm	1	3833-98-C	
102 mm	1	3833-102-C	
105 mm	1	3833-105-C	
108 mm	1	3833-108-C	
109 mm	1	3833-109-C	
111 mm	1	3833-111-C	
114 mm	1	3833-114-C	
121 mm	1	3833-121-C	
127 mm	1	3833-127-C	
133 mm	1	3833-133-C	
140 mm	1	3833-140-C	
152 mm	1	3833-152-C	
159 mm	1	3833-159-C	
168 mm	1	3833-168	
177 mm	1	3833-177	
210 mm	1	3833-210	
225 mm	1	3833-225	

Superior™ Multi Construction Holesaw Set 32–83 mm - 6 pcs



3833-PROMO-42

1489 g	1 3833-PROMO-42

3833-32-C, 3833-51-C, 3833-76-C, 3833-83-C	
3834-ARBR-9100EL	
3834-UPSIZING	

Superior™ Multi Construction Holesaw Set 19 mm-64 mm - 10 Pcs



3833-SET-101

2.75 kg	1 3833-SET-101

3833-19-C, 3833-22-C, 3833-29-C, 3833-35-C, 3833-44-C, 3833-51-C, 3833-64-C	
3834-ARBR-930EL, 3834-ARBR-9100EL	
3834-DRL-EL	

Superior™ Multi Construction Holesaw Set 19 mm-86 mm - 14 Pcs



3833-SET-201

4.35 kg	1 3833-SET-201

3833-19-C, 3833-20-C, 3833-25-C, 3833-32-C, 3833-41-C, 3833-51-C, 3833-73-C, 3833-76-C, 3833-83-C, 3833-86-C	
3834-ARBR-930EL, 3834-ARBR-9100EL	
3834-DRL-EL	
3834-UPSIZING	

Superior™ Multi Construction Holesaw Set 19 mm-83 mm - 14 Pcs



3833-SET-202

4.1 kg	1 3833-SET-202

3833-19-C, 3833-20-C, 3833-25-C, 3833-32-C, 3833-41-C, 3833-51-C, 3833-57-C, 3833-60-C, 3833-73-C, 3833-83-C	
3834-ARBR-930EL, 3834-ARBR-9100EL	
3834-DRL-EL	
3834-UPSIZING	



Superior™ Multi Construction Holesaw Set
19 mm-78 mm - 14 Pcs



3833-SET-203



4.65 kg



1 3833-SET-203

3833-19-C, 3833-22-C, 3833-54-C, 3833-56-C,
3833-57-C, 3833-62-C, 3833-68-C, 3833-71-C,
3833-74-C, 3833-78-C

3834-ARBR-930EL, 3834-ARBR-9100EL

3834-DRL-EL

3834-UPSIZ

Superior™ Multi Construction Holesaw Set
22 mm-67 mm - 9 Pcs



3833-SET-205



2.81 kg



1 3833-SET-205

3833-22-C, 3833-35-C, 3833-44-C, 3833-51-C,
3833-67-C

3834-ARBR-930EL, 3834-ARBR-9100EL

3834-DRL-EL

3834-UPSIZ

Superior™ Multi Construction Holesaw Set
19 mm-76 mm - 15 Pcs



3833-SET-208



3.72 kg



1 3833-SET-208

3833-19-C, 3833-22-C, 3833-25-C, 3833-32-C,
3833-35-C, 3833-38-C, 3833-44-C, 3833-51-C,
3833-57-C, 3833-68-C, 3833-76-C

3834-ARBR-930EL, 3834-ARBR-9100EL

3834-DRL-EL

3834-UPSIZ

Superior™ Multi Construction Holesaw Set
32 mm-86 mm - 10 Pcs



3833-SET-204



3.88 kg



1 3833-SET-204

3833-32-C, 3833-41-C, 3833-51-C, 3833-73-C,
3833-76-C, 3833-83-C, 3833-86-C

3834-ARBR-9100EL

3834-DRL-EL

3834-UPSIZ

Superior™ Multi Construction Holesaw Set
19 mm-83 mm - 14 Pcs



3833-SET-207



3.90 kg



1 3833-SET-207

3833-19-C, 3833-22-C, 3833-25-C, 3833-35-C,
3833-44-C, 3833-51-C, 3833-64-C, 3833-67-C,
3833-76-C, 3833-83-C

3834-ARBR-930EL, 3834-ARBR-9100EL

3834-DRL-EL

3834-UPSIZ

Superior™ Multi Construction Holesaw Set
25 mm-114 mm - 12 Pcs



3833-SET-301



4.38 kg



1 3833-SET-301

3833-25-C, 3833-32-C, 3833-35-C, 3833-51-C,
3833-54-C, 3833-76-C, 3833-92-C, 3833-114-C

3834-ARBR-930EL, 3834-ARBR-9100EL

3834-DRL-EL

3834-UPSIZ

Superior™ Multi Construction Holesaw Set
51 mm-111 mm - 7 Pcs



3833-SET-302



3.51 kg

1 3833-SET-302

3833-51-C, 3833-76-C, 3833-86-C, 3833-111-C

3834-ARBR-9100EL

3834-DRL-EL

3834-UPSIZE

Superior™ Multi Construction Holesaw Set
35 mm-114 mm - 11 Pcs



3833-SET-303



4.17 kg

1 3833-SET-303

3833-35-C, 3833-40-C, 3833-51-C, 3833-57-C,

3833-60-C, 3833-74-C, 3833-83-C, 3833-105-C

3834-ARBR-9100EL

3834-DRL-EL

3834-UPSIZE

Superior™ Multi Construction Holesaw Set
19 mm-114 mm - 13 Pcs



3833-SET-304



4.20 kg

1 3833-SET-304

3833-19-C, 3833-25-C, 3833-32-C, 3833-35-C,

3833-51-C, 3833-54-C, 3833-76-C, 3833-92-C,

3833-114-C

3834-ARBR-930EL, 3834-ARBR-9100EL

3834-DRL-EL

3834-UPSIZE

Carbide Tipped Holesaws for Stainless
Steel/Fibreglass/Masonry 14 mm -152 mm



3832



14 mm

6 3832-14

16 mm

6 3832-16

17 mm

6 3832-17

19 mm

6 3832-19

20 mm

6 3832-20

21 mm

6 3832-21

22 mm

6 3832-22

24 mm

6 3832-24

25 mm

6 3832-25

27 mm

6 3832-27

29 mm

6 3832-29

30 mm

6 3832-30

32 mm

6 3832-32

33 mm

6 3832-33



35 mm

6 3832-35

37 mm

6 3832-37

38 mm

6 3832-38

40 mm

6 3832-40

41 mm

6 3832-41

43 mm

6 3832-43

44 mm

6 3832-44

46 mm

6 3832-46

48 mm

6 3832-48

51 mm

6 3832-51

52 mm

4 3832-52

54 mm

4 3832-54

56 mm

4 3832-56

57 mm

4 3832-57

59 mm

4 3832-59

60 mm

4 3832-60

64 mm

4 3832-64

65 mm

4 3832-65

67 mm

4 3832-67

68 mm

4 3832-68

70 mm

4 3832-70

73 mm

4 3832-73

76 mm

4 3832-76

79 mm

4 3832-79

83 mm

4 3832-83

86 mm

4 3832-86

89 mm

4 3832-89

92 mm

4 3832-92

95 mm

4 3832-95

98 mm

4 3832-98

102 mm

4 3832-102

105 mm

4 3832-105

108 mm

4 3832-108

111 mm

4 3832-111

114 mm

4 3832-114

121 mm

1 3832-121

127 mm

1 3832-127

133 mm

1 3832-133

140 mm

1 3832-140

146 mm

1 3832-146

152 mm

1 3832-152

16 mm

1 3832-16-C

19 mm

1 3832-19-C

20 mm

1 3832-20-C

22 mm

1 3832-22-C

24 mm

1 3832-24-C

25 mm

1 3832-25-C

29 mm

1 3832-29-C

30 mm

1 3832-30-C

32 mm

1 3832-32-C

35 mm

1 3832-35-C

38 mm

1 3832-38-C

41 mm

1 3832-41-C

44 mm

1 3832-44-C

46 mm

1 3832-46-C

48 mm

1 3832-48-C

51 mm

1 3832-51-C

54 mm

1 3832-54-C

57 mm

1 3832-57-C

60 mm

1 3832-60-C

64 mm

1 3832-64-C

73 mm

1 3832-73-C

76 mm

1 3832-76-C

83 mm

1 3832-83-C

86 mm

1 3832-86-C

92 mm

1 3832-92-C

102 mm

1 3832-102-C

114 mm

1 3832-114-C

127 mm

1 3832-127-C

-C: packed in a self-service packaging that works as a tooth protector



Carbide Tipped Holesaw Sets for Stainless Steel 25 mm -114 mm - 12 Pcs



3832-SET-84-ES

3600 g	1	3832-SET-84-ES

- 3832-25-C, 3832-30-C, 3832-35-C, 3832-51-C, 3832-54-C, 3832-76-C, 3832-92-C, 3832-114-C
- 3834-ARBR-9100ESM, 3834-ARBR-930ESM
- 3834-DRL-HSS-ES
- 3834-UPSIZ

Carbide Tipped Holesaw Sets for Stainless Steel 16 mm-114 mm - 20 Pcs



3832-SET-164-ES

4800 g	1	3832-SET-164-ES

- 3832-16-C, 3832-20-C, 3832-25-C, 3832-32-C, 3832-35-C, 3832-41-C, 3832-44-C, 3832-46-C, 3832-51-C, 3832-54-C, 3832-73-C, 3832-76-C, 3832-83-C, 3832-86-C, 3832-92-C, 3832-114-C
- 3834-ARBR-9100ESM, 3834-ARBR-930ESM
- 3834-DRL-HSS-ES
- 3834-UPSIZ

Holesaw Set, Mixed 35-114 mm - 10 pcs



3835-SET-64

10	3870 g	1	3835-SET-64

- 3830-35-C, 3830-73-C
- 3833-35-C, 3833-73-C, 3833-76-C, 3833-114-C
- 3834-ARBR-9100QC-C
- 3834-ARBR-9100EL
- 3834-DRL-EL
- 3834-DRL

Holesaw Set, Mixed 12-86 mm - 18 pcs



3835-SET-711

18	3680 g	1	3835-SET-711

- 3830-35-C, 3830-41-C, 3830-51-C, 3830-73-C, 3830-76-C, 3830-83-C, 3830-86-C
- 9629-12, 9629-14, 9629-16, 9629-18, 9629-20, 9629-22, 9629-25, 9629-28, 9629-32
- 3834-ARBR-9100ESM
- 3834-DRL-HSS-ES

Arbors with Quick-Eject Function - Saves time and energy



3834-ARBR-EL/ES

19-30 mm	8.5 mm	1	3834-ARBR-930EL
32-159 mm	8.5 mm	1	3834-ARBR-9100EL
16-30 mm	8.5 mm	1	3834-ARBR-930ESM
32-152 mm	8.5 mm	1	3834-ARBR-9100ESM

Pilot Drills for Long Quick-Eject Arbors



3834-DRL-EL

6.35 mm	202 mm	1	3834-DRL-EL

Pilot Drills for Short Quick-Eject Arbors



3834-DRL-HSS-ES

6.35 mm	138 mm	1	3834-DRL-ES
6.35 mm	138 mm	1	3834-DRL-HSS-ES

Upsize Adaptors for Enlarging Existing Holes



3834-upsize

20.5 mm	1	3834-UPSIZ

Arbors for small holesaws 14-30mm



3834-ARBR

14-30 mm	6.4 mm	1	3834-ARBR-630
14-30 mm	6.4 mm	1	3834-ARBR-630-C
14-30 mm	6.4 mm	1	3834-ARBR-730
14-30 mm	6.4 mm	1	3834-ARBR-730-C
14-30 mm	8.5 mm	1	3834-ARBR-930
14-30 mm	8.5 mm	1	3834-ARBR-930-C
14-30 mm	11.1 mm	4	3834-ARBR-1130
14-30 mm	11.1 mm	1	3834-ARBR-1130-C

Arbors with Quick-Change Function



3834-ARBR-QC

14-30 mm	8.5 mm	1	3834-ARBR-930QC-C
32-152 mm	8.5 mm	1	3834-ARBR-9100
32-152 mm	8.5 mm	1	3834-ARBR-9100-C
32-152 mm	8.5 mm	1	3834-ARBR-9100QC
32-152 mm	8.5 mm	1	3834-ARBR-9100QC-C
32-210 mm	11.1 mm	1	3834-ARBR-11152
32-210 mm	11.1 mm	1	3834-ARBR-11152-C
32-210 mm	11.1 mm	1	3834-ARBR-11152QC
32-210 mm	11.1 mm	1	3834-ARBR-11152QC-C
32-210 mm	15.4 mm	1	3834-ARBR-16152
32-210 mm	15.4 mm	1	3834-ARBR-16152QC

Arbors with SDS+ Drive



3834-ARBR-SD

14-30 mm	SDS+ mm	1	3834-ARBR-SD30	
32-210 mm	SDS+ mm	1	3834-ARBR-SD152QC	

HSS Pilot Drills for Arbors



3834-DRL

6.35 mm	81 mm	1	3834-DRL

Carbide Tipped Pilot Drills for Arbors



3834-DRL-CT/L

6.35 mm	81 mm	1	3834-DRL-CT
6.35 mm	114 mm	1	3834-DRL-L

Arbor Extensions



3834-EXT

11.1 mm	330 mm	1	3834-EXT-1
8.5 mm	330 mm	1	3834-EXT-2

Ejector Spring for arbors



3834-ES

10 g	1	3834-ES

Arbor Adaptor for 3834-ARBR-630, 730, 930 and 1130



3834-ADP

20 g	1	3834-ADP



Spare Screws for Arbors



3834-SCREWS

g			
9 g	1	3834-M6X29-SET	
9 g	1	3834-M8X5-SET	
9 g	1	3834-M8X6-SET	
9 g	1	3834-M8X10-SET	

SABRE SAWBLADES

Sandflex® Bi-Metal Sabre Sawblade Set for Metal



3940-M

100 mm	14	10	3940-100-14-ST-2P
100 mm	14	5	3940-100-14-ST-5P
100 mm	14	1	3940-100-14-ST-10P
100 mm	18	10	3940-100-18-ST-2P
100 mm	18	5	3940-100-18-ST-5P
100 mm	18	1	3940-100-18-ST-10P
150 mm	14	10	3940-150-14-ST-2P
150 mm	14	5	3940-150-14-ST-5P
150 mm	14	1	3940-150-14-ST-10P
150 mm	14	1	3940-150-14-ST-100P
150 mm	18	10	3940-150-18-ST-2P
150 mm	18	5	3940-150-18-ST-5P
150 mm	18	1	3940-150-18-ST-10P
150 mm	18	1	3940-150-18-ST-100P
228 mm	14	10	3940-228-14-ST-2P
228 mm	14	5	3940-228-14-ST-5P
228 mm	14	1	3940-228-14-ST-10P
228 mm	14	1	3940-228-14-ST-100P
228 mm	18	10	3940-228-18-ST-2P
228 mm	18	5	3940-228-18-ST-5P
228 mm	18	1	3940-228-18-ST-10P
228 mm	18	1	3940-228-18-ST-100P
300 mm	14	10	3940-300-14-ST-2P
300 mm	14	5	3940-300-14-ST-5P
300 mm	14	1	3940-300-14-ST-10P
300 mm	14	1	3940-300-14-ST-100P
300 mm	18	10	3940-300-18-ST-2P
300 mm	18	5	3940-300-18-ST-5P
300 mm	18	1	3940-300-18-ST-10P
300 mm	18	1	3940-300-18-ST-100P

Sandflex® Bi-Metal Sabre Sawblade Set for Heavy Metal



3940-HM

150 mm	8/12	10	3940-150-8/12-ST-2P
150 mm	8/12	5	3940-150-8/12-ST-5P
150 mm	8/12	1	3940-150-8/12-ST-10P
150 mm	8/12	1	3940-150-8/12-ST-100P
228 mm	8/12	5	3940-228-8/12-ST-2P
228 mm	8/12	5	3940-228-8/12-ST-5P
228 mm	8/12	1	3940-228-8/12-ST-10P
228 mm	8/12	1	3940-228-8/12-ST-100P
150 mm	10	10	3940-150-10-HST-2P
150 mm	10	5	3940-150-10-HST-5P
150 mm	10	1	3940-150-10-HST-10P
150 mm	10	1	3940-150-10-ST-100P
150 mm	10	5	3940-150-10-ST-2P
150 mm	10	5	3940-150-10-ST-5P
150 mm	10	1	3940-150-10-ST-10P
150 mm	14	10	3940-150-14-HST-2P
150 mm	14	5	3940-150-14-HST-5P
150 mm	14	1	3940-150-14-HST-10P
150 mm	18	10	3940-150-18-HST-2P
150 mm	18	5	3940-150-18-HST-5P
150 mm	18	1	3940-150-18-HST-10P
228 mm	10	10	3940-228-10-HST-2P
228 mm	10	5	3940-228-10-HST-5P
228 mm	10	1	3940-228-10-HST-10P
228 mm	10	1	3940-228-10-HST-100P
228 mm	10	10	3940-228-10-ST-2P
228 mm	10	5	3940-228-10-ST-5P
228 mm	10	1	3940-228-10-ST-10P
228 mm	10	1	3940-228-10-ST-100P
228 mm	14	10	3940-228-14-HST-2P
228 mm	14	5	3940-228-14-HST-5P
228 mm	14	1	3940-228-14-HST-10P
228 mm	14	1	3940-228-14-HST-100P
228 mm	18	10	3940-228-18-HST-2P
228 mm	18	5	3940-228-18-HST-5P
228 mm	18	1	3940-228-18-HST-10P
228 mm	18	1	3940-228-18-HST-100P
300 mm	10	10	3940-300-10-HST-2P
300 mm	10	5	3940-300-10-HST-5P
300 mm	10	1	3940-300-10-HST-10P
300 mm	14	10	3940-300-14-HST-2P
300 mm	14	5	3940-300-14-HST-5P
300 mm	14	1	3940-300-14-HST-10P
300 mm	18	10	3940-300-18-HST-2P
300 mm	18	5	3940-300-18-HST-5P
300 mm	18	1	3940-300-18-HST-10P

Sandflex® Bi-Metal Sabre Sawblade Set for Fine Metal



3940-FM

100 mm	24	10	3940-100-24-ST-2P
100 mm	24	5	3940-100-24-ST-5P
100 mm	24	1	3940-100-24-ST-10P
150 mm	24	5	3940-150-24-ST-2P
150 mm	24	5	3940-150-24-ST-5P
150 mm	24	1	3940-150-24-ST-10P
150 mm	24	1	3940-150-24-ST-100P

Sandflex® Bi-Metal Sabre Sawblade Set for Precision Metal



3940-PM

100 mm	14	10	3940-100-14-SC-2P
100 mm	14	5	3940-100-14-SC-5P
100 mm	18	10	3940-100-18-SC-2P
100 mm	18	5	3940-100-18-SC-5P
100 mm	24	10	3940-100-24-SC-2P
100 mm	24	5	3940-100-24-SC-5P

Sabre Saw Tungsten Carbide Tipped Blades for Heavy Duty Metal



3946-C_HM

150 mm	8	10	3946-150-8-HST-1P
228 mm	8	10	3946-228-8-HST-1P
300 mm	8	10	3946-300-8-HST-1P

10P = 10 pieces

Sabre Saw Tungsten Carbide Tipped Blades for Stainless Steel



3946-C_SS

Length	Teeth	Material	Part No.
150 mm	10	10	3946-150-10-HST-1P
228 mm	10	10	3946-228-10-HST-1P
300 mm	10	10	3946-300-10-HST-1P

Sabre Saw Diamond Grit Blades For Cast Iron And Ceramics



3946-D_CI

Length	Grit	Material	Part No.
100 mm	Grit	10	3946-100-DG-ST-2P
150 mm	Grit	10	3946-150-DG-ST-2P

Car Body Sandflex® Bi-Metal Reciprocating Sawblades



3845

Length	Teeth	Material	Part No.
91.5 mm	18	1	3845-18-10P
91.5 mm	24	1	3845-24-10P
90 mm	32	1	3845-32-10P

Sandflex® Bi-Metal Sabre Sawblades for Wood and Metal



3940-WM

Length	Teeth	Material	Part No.
150 mm	4/6	10	3940-150-4/6-SC-2P
150 mm	4/6	5	3940-150-4/6-SC-5P
150 mm	4/6	1	3940-150-4/6-SC-10P

Length	Teeth	Material	Part No.
150 mm	5/8	10	3940-150-5/8-SL-2P
150 mm	5/8	5	3940-150-5/8-SL-5P
150 mm	5/8	1	3940-150-5/8-SL-10P
150 mm	5/8	1	3940-150-5/8-SL-100P
150 mm	6	10	3940-150-6-ST-2P
150 mm	6	5	3940-150-6-ST-5P
150 mm	6	1	3940-150-6-ST-10P
228 mm	6	10	3940-228-6-SL-2P
228 mm	6	5	3940-228-6-SL-5P
228 mm	6	1	3940-228-6-SL-10P
300 mm	6	10	3940-300-6-SL-2P
300 mm	6	5	3940-300-6-SL-5P
300 mm	6	1	3940-300-6-SL-10P
300 mm	8/12	5	3940-300-8/12-SL-2P
300 mm	8/12	5	3940-300-8/12-SL-5P
300 mm	8/12	1	3940-300-8/12-SL-10P
300 mm	8/12	1	3940-300-8/12-SL-100P

Sandflex® Bi-Metal Sabre Sawblades for Fire Fighters and Rescuers



3940-FR

Length	Teeth	Material	Part No.
228 mm	10	10	3940-228-10-DSL-2P
228 mm	10	5	3940-228-10-DSL-5P
228 mm	10	1	3940-228-10-DSL-10P
228 mm	10	1	3940-228-10-DSL-100P

Sandflex® Bi-Metal Sabre Sawblades for Demolition



3940-D

Length	Teeth	Material	Part No.
150 mm	5/8	5	3940-150-5/8-DSL-2P
150 mm	5/8	5	3940-150-5/8-DSL-5P
150 mm	5/8	1	3940-150-5/8-DSL-10P
228 mm	5/8	10	3940-228-5/8-DSL-2P
228 mm	5/8	5	3940-228-5/8-DSL-5P
228 mm	5/8	1	3940-228-5/8-DSL-10P
300 mm	5/8	10	3940-300-5/8-DSL-2P
300 mm	5/8	5	3940-300-5/8-DSL-5P
300 mm	5/8	1	3940-300-5/8-DSL-10P

Sandflex® Bi-Metal Sabre Sawblades for Pallet Repair



3940-PR

Length	Teeth	Material	Part No.
228 mm	10/14	1	3940-228-10/14-PR13-10P
228 mm	10/14	1	3940-228-10/14-PR09-10P
228 mm	10/14	1	3940-228-10/14-PR09-100P
228 mm	10/14	1	3940-228-10/14-PR13-100P
228 mm	8/12	1	3940-228-8/12-PR13-100P
228 mm	10	1	3940-228-10-PR09-100P

Sabre Saw Tungsten Carbide Tipped Blades for Wood & Nails



3946-C_WM

Length	Teeth	Material	Part No.
150 mm	6	10	3946-150-6-DSL-1P
228 mm	6	10	3946-228-6-DSL-1P
300 mm	6	10	3946-300-6-DSL-1P

Sabre Saw HCS Blades for Wood



3942-W

Length	Teeth	Material	Part No.
228 mm	7	10	3942-228-7-HSL-2P
228 mm	7	5	3942-228-7-HSL-5P
228 mm	7	1	3942-228-7-HSL-10P
300 mm	7	10	3942-300-7-HSL-2P
300 mm	7	5	3942-300-7-HSL-5P
300 mm	7	1	3942-300-7-HSL-10P



Sabre Saw HCS Blades for Coarse Wood



3942-CW

Length	Teeth	Quantity	Part Number
228 mm	5	10	3942-228-5-HSL-2P
228 mm	5	5	3942-228-5-HSL-5P
228 mm	5	1	3942-228-5-HSL-10P
300 mm	5	10	3942-300-5-HSL-2P
300 mm	5	5	3942-300-5-HSL-5P
300 mm	5	1	3942-300-5-HSL-10P

Reciprocating Curved Saw Blade for Fine Cut



3943-C30-JT-F

Length	Quantity	Part Number
323 mm	10	3943-C30-JT-F
13 in	10	3943-C30-JT-F

Reciprocating Straight Saw Blade for Fine Cut



3943-S20-JT-F

Length	Quantity	Part Number
228 mm	10	3943-S20-JT-F
9 in	10	3943-S20-JT-F

Sabre Saw HCS Blades for Wood and Plastic



3942-WP

Length	Teeth	Quantity	Part Number
228 mm	11	10	3942-228-11-HSL-2P
228 mm	11	5	3942-228-11-HSL-5P
228 mm	11	1	3942-228-11-HSL-10P

Reciprocating Curved Saw Blade for Medium Cut



3943-C30-JT-M

Length	Quantity	Part Number
323 mm	10	3943-C30-JT-M
13 in	10	3943-C30-JT-M
373 mm	10	3943-C35-JT-M
15 in	10	3943-C35-JT-M

Reciprocating Straight Saw Blade for Coarse Cut



3943-R28-UT-C-2P

Length	Quantity	Part Number
300 mm	10	3943-R28-UT-C-2P
12 in	10	3943-R28-UT-C-2P

Sandflex® Bi-Metal Sabre Sawblades for Plaster and Boards



3942-PB

Length	Teeth	Quantity	Part Number
150 mm	7	10	3942-150-7-SL-2P
150 mm	7	5	3942-150-7-SL-5P
150 mm	7	1	3942-150-7-SL-10P
228 mm	7	10	3942-228-7-SL-2P
228 mm	7	5	3942-228-7-SL-5P
228 mm	7	1	3942-228-7-SL-10P
300 mm	7	10	3942-300-7-SL-2P
300 mm	7	5	3942-300-7-SL-5P
300 mm	7	1	3942-300-7-SL-10P

Reciprocating Long Curved Saw Blade for Coarse Cut



3943-C35-JT-C

Length	Quantity	Part Number
373 mm	10	3943-C35-JT-C
15 in	10	3943-C35-JT-C

Sandflex® Bi-Metal Sabre Sawblades Set for Metal - 5 Pcs

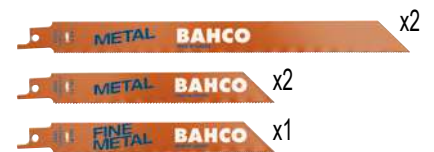

3940-METAL-SET-5P

Quantity	Weight	Part Number
5	125 g	3940-METAL-SET-5P

3940-150-14-ST, 3940-150-18-ST, 3940-150-24-ST, 3940-228-18-ST, 3940-228-14-ST

Sandflex® Bi-Metal Sabre Sawblades Set for Metal - 12 Pcs



3940-METAL-SET-12P

12	460 g	6	3940-METAL-SET-12P

Sandflex® Bi-Metal Sabre Sawblades Set for Heavy Metal and Demolition - 5 Pcs



3940-HDD-SET-5P

5	222 g	5	3940-HDD-SET-5P

3940-150-5/8-DSL, 3940-228-5/8-DSL, 3940-228-10-DSL, 3940-150-14-HST, 3940-228-14-HST

Sabre Sawblades Set for Wood and Metal - 5 Pcs



3940-MIX-SET-5P

5	150 g	5	3940-MIX-SET-5P

3940-100-24-SC, 3940-150-18-ST, 3940-150-14-ST, 3940-228-6-SL, 3942-228-7-HSL

Sabre Sawblades Set for Plaster Wood and Metal - 10 Pcs



3940-MIX-SET-10P

10	245 g	4	3940-MIX-SET-10P

3940-100-24-SC, 3940-100-18-SC, 3940-150-24-ST, 3940-150-18-ST, 3940-150-14-ST, 3940-150-10-ST, 3940-228-6-SL, 3942-228-11-HSL, 3942-228-7-HSL, 3942-150-7-SL

Sabre Sawblades Set for Wood and Metal - 12 Pcs



3940-MIX-SET-12P

12	480 g	6	3940-MIX-SET-12P

Sabre Sawblades Set for Wood - 5 Pcs



3942-WOOD-SET-5P

5	191 g	5	3942-WOOD-SET-5P

3940-228-6-SL, 3942-228-11-HSL, 2x 3942-228-7-HSL, 3942-150-7-SL

Sabre Sawblades Set for Wood - 12 Pcs



3942-WOOD-SET-12P

12	525 g	6	3942-WOOD-SET-12P

Sabre Saw Stainless Steel Blades for Meat and Ice



3944

300 mm	4	10	3944-300-3-MEAT-1P

Sabre Saw Tungsten Carbide Tipped Blades for Stone Materials



3946-CT

150 mm	6	5	3946-150-6-SL-1P
228 mm	3	5	3946-228-3-ST-1P

Sabre Saw Tungsten Carbide Tipped Blades for Bricks, LECA and Aerated Concrete



3946-C B

300 mm	2	10	3946-300-2-CB-1P
457 mm	2	10	3946-457-2-CB-1P



JIGSAW BLADES

T-Shank Jigsaw Blades for Metal Cutting



91-M

L	mm	mm	mm	mm	mm	mm	mm	mm	mm
100	mm	15/23	mm	1	91-3PM-5P				
100	mm	8	mm	1	91-433-5P				
77	mm	36	mm	1	91-502-5P				
77	mm	21	mm	1	91-512-5P				
77	mm	21	mm	1	91-512-25P				
77	mm	21	mm	1	91-517-5P				
77	mm	13	mm	1	91-522-5P				
132	mm	25	mm	1	91-611-5P				
77	mm	21	mm	1	91-612-5P				
77	mm	13	mm	1	91-622-5P				
132	mm	14	mm	1	91-7V1-5P				

T-Shank Jigsaw Blades for Wood and Metal Cutting



91-WM

L	mm	mm	mm	mm	mm
132	mm	10/14	mm	1	91-4PWM-5P
100	mm	10/14	mm	1	91-623-5P

T-Shank Jigsaw Blades for Wood Cutting



91-W

L	mm	mm	mm	mm	mm
117	mm	10	mm	1	91-2PW-5P
132	mm	8	mm	1	91-434-5P
105	mm	6	mm	1	91-444-5P
100	mm	8	mm	1	91-023-5P
77	mm	12	mm	1	91-027-5P
100	mm	6	mm	1	91-143-5P
100	mm	6	mm	1	91-143-25P
100	mm	6	mm	1	91-143-100P
100	mm	6	mm	1	91-148-5P
100	mm	10	mm	1	91-223-5P
100	mm	10	mm	1	91-226-5P
132	mm	6	mm	1	91-233-5P
100	mm	6	mm	1	91-243-5P
77	mm	19	mm	1	91-412-5P
100	mm	6	mm	1	91-443-5P

Jigsaw Blade Set for Metal - 10 pcs



91-METAL-10P

X	mm	mm	mm	mm	mm
10	mm		1	91-METAL-10P	

x3 91-512 (T118A), x3 91-522 (T118B), x1 91-433 (T127DF), x1 91-502 (T118G), x2 91-4PWM (T111HF)

Jigsaw Blade Set for Wood and Plastic - 10 pcs



91-WOOD-10P

X	mm	mm	mm	mm	mm
10	mm		1	91-WOOD-10P	

x4 91-143 (T144D), x2 91-223 (T101B), x2 91-023 (T111C), x1 91-148 (T244D), x1 91-226 (T101BR)

Jigsaw Blade Set for Wood and Metal - 10 pcs



91-MIXED-10P

X	mm	mm	mm	mm	mm
10	mm		1	91-MIXED-10P	

x3 91-143 (T144D), x1 91-223 (T101B), x1 91-148 (T244D), x2 91-512 (T118A), x2 91-522 (T118B), x1 91-623 (T111HF)

MULTI TOOL ACCESSORIES

Multi-Tool Standard Blade for Wood Cutting



92-S W

X	mm	mm	mm	mm	mm
1	35 x 50 x 97	mm	70	92-133-1P	
3	35 x 50 x 97	mm	46	92-133-3P	
25	35 x 50 x 97	mm	1	92-133-25P	

Multi-Tool Standard Blade for Precision Wood Cutting



92-P W

X	mm	mm	mm	mm	mm
1	30 x 50 x 97	mm	70	92-205-1P	
3	30 x 50 x 97	mm	46	92-205-3P	
1	65 x 50 x 97	mm	70	92-229-1P	
25	30 x 50 x 97	mm	1	92-205-25P	

Multi-Tool Curved Standard Blade for Wood Cutting



92-C W

X	mm	mm	mm	mm	mm
1	65 x 50 x 97	mm	70	92-225-1P	
25	65 x 50 x 97	mm	1	92-225-25P	

Multi-Tool Standard Blade for Universal Cutting of Wood with Nails



92-U_WN

1	35 x 50 x 97 mm	70 92-160-1P
3	35 x 50 x 97 mm	46 92-160-3P
25	35 x 50 x 97 mm	1 92-160-25P

Multi-Tool Starlock Plus Blade for Universal Cutting of Wood with Metal



92-PU_WM

25	28 x 60 x 107 mm	1 92-151-25P
25	44 x 60 x 107 mm	1 92-152-25P

Multi-Tool Segment Blade for Metal Cutting



92-M_S

1	85 mm	90 92-106-1P

Multi-Tool Long-Life Standard Blade for Cutting Wood with Nails



92-LF_WN

1	50 x 50 x 97 mm	70 92-221-1P
1	65 x 50 x 97 mm	70 92-228-1P
25	65 x 50 x 97 mm	1 92-228-25P

Multi-Tool Carbide Tipped Blade with TiN Coating for Metal Cutting



92-C_M

25	35 x 42 x 82 mm	1 92-236-25P
1	35 x 42 x 82 mm	70 92-236-1P

Multi-Tool Segment Blade for Wood Cutting



92-SP

1	85 mm	90 92-113-1P

Multi-Tool Standard Blade for Universal Cutting of Wood with Metal



92-U_WM

1	28 x 55 x 100 mm	70 92-222-1P
3	28 x 55 x 100 mm	46 92-222-3P
25	28 x 55 x 100 mm	1 92-222-25P
1	44 x 55 x 100 mm	70 92-223-1P
3	44 x 55 x 100 mm	46 92-223-3P
25	44 x 55 x 100 mm	1 92-223-25P

Multi-Tool Standard Blade for Fine Cutting in Metal



92-FM

1	30 x 50 x 97 mm	70 92-157-1P
25	35 x 50 x 97 mm	1 92-157-25P

Multi-Tool Circular Blade for Metal Cutting



92-M_R

115	85 mm	90 92-174-1P



Multi-Tool Standard Blade Set for Wood and Metal Cutting - 8 pcs



92-Universal WM_Set

8	32 x 160 x 195 mm	34	92-WM-SET-8P

92-222-1Px 2, 92-223-1Px 2

92-228-1Px 2

92-160-1Px 2

Multi-Tool Segment Blade for Slots and Reworking



92-CG_S

1	75 mm	90	92-118-1P

Multi-Tool Segment Blade for Marble and Epoxy



92-DG_S

1	90 mm	50	92-166-1P

Multi-Tool Triangular Blade for Rasping and Reworking



92-CR_T

1	80 mm	90	92-001-1P

Multi-Tool Standard Knife for Soft Materials



92-MFK

1	41 x 42 x 87 mm	70	92-251-1P

Multi-Tool Standard Scraper Blades



92-SC

1	52 x 38 x 83 mm	90	92-165-1P
1	50 x 38 x 83 mm	90	92-226-1P

Multi-Tool Mushroom Shape Cutting Blade



92-CM

1	70 x 30 x 75 mm	90	92-245-1P

Multi-Tool Triangular Sanding Pads



92-Sanding Pads

1	80 mm	20	92-136-1P
1	93 mm	50	92-137-1P

Multi-Tool Triangular Sanding Paper



92 Sanding Paper

5	82 mm	10	92-136-G40-5P
5	82 mm	10	92-136-G80-5P
5	82 mm	10	92-136-G120-5P
5	82 mm	10	92-136-G240-5P
5	94 mm	10	92-137-G40-5P
5	94 mm	10	92-137-G80-5P
5	94 mm	10	92-137-G120-5P
5	94 mm	10	92-137-G240-5P

CIRCULAR SAW BLADES

Circular Saw blades for Cordless Saws in Wood



8501-C

Ø	Teeth	Icons	Part No.
136 mm	24		8501-136-10-24C
136 mm	24		8501-136-20-24C
150 mm	24		8501-150-10-24C
160 mm	24		8501-160-20-24C
165 mm	24		8501-165-20-24C
184 mm	24		8501-184-20-24C
190 mm	24		8501-190-30-24C

Circular Saw blades for Portable-/Table Saws in Wood



8501-P/T

Ø	Teeth	Icons	Part No.
125 mm	16		8501-2
130 mm	16		8501-3
140 mm	16		8501-4
140 mm	24		8501-4F
140 mm	30		8501-4XF
150 mm	18		8501-5
150 mm	30		8501-5F
160 mm	18		8501-7
160 mm	30		8501-7F
170 mm	18		8501-10
170 mm	30		8501-10F
180 mm	20		8501-12
180 mm	40		8501-12F
184 mm	24		8501-13
184 mm	40		8501-13F
184 mm	24		8501-184-16-24
184 mm	40		8501-184-16-40
190 mm	20		8501-15
190 mm	40		8501-15F
190 mm	60		8501-190-30-60XF
200 mm	20		8501-16
200 mm	40		8501-16F
210 mm	20		8501-17

Ø	Teeth	Icons	Part No.
210 mm	40		8501-17F
210 mm	60		8501-210-30-60XF
230 mm	20		8501-22
230 mm	40		8501-22F
230 mm	60		8501-230-30-60XF
235 mm	30		8501-23
235 mm	40		8501-23F
235 mm	60		8501-235-30-60XF
250 mm	24		8501-28
250 mm	40		8501-28F
250 mm	60		8501-28XF

Circular Saw blades for Plunge Saws in Wood



8501-P

Ø	Teeth	Icons	Part No.
160 mm	48		8501-160-20-48XF
165 mm	48		8501-165-20-48XF

Circular Saw blades for Mitre Saws in Wood



8501-M

Ø	Teeth	Icons	Part No.
210 mm	48		8501-210-30-48SW
216 mm	24		8501-16SW
216 mm	48		8501-18SW
216 mm	60		8501-216-60SW
250 mm	60		8501-28SW
260 mm	24		8501-260-24SW
260 mm	40		8501-260-40SW
260 mm	60		8501-260-60SW
300 mm	60		8501-30SW
305 mm	40		8501-305-30-40SW
305 mm	60		8501-305-30-60SW

Circular Saw blades for Site Saws in Wood



8501-S

Ø	Teeth	Icons	Part No.
300 mm	30		8501-30
300 mm	40		8501-30F
300 mm	60		8501-30XF
315 mm	30		8501-31
315 mm	40		8501-31F
400 mm	40		8501-40

Circular Saw blades for Mitre Saws in Aluminium and Plastic



8501-AP

Ø	Teeth	Icons	Part No.
210 mm	48		8501-17S
216 mm	48		8501-18S
250 mm	80		8501-28S
260 mm	80		8501-260-30-80S
300 mm	96		8501-30S
305 mm	96		8501-305-30-96S



ABRASIVE CUTTING DISCS

Abrasive High-Performance Cutting Discs for General Purpose Inox & Metal



391-T41_IM

Ø	Icons	Quantity	Product Code
230x1.9 mm		50	3911-2301922XDT
230x2.5 mm		50	3911-2302522XDT
75x1.0 mm		10	3911-751010XTM
115x1.6 mm		50	3911-115-T41-IM
115x1.0 mm		25	3911-1151T41-IM
125x1.6 mm		50	3911-125-T41-IM
180x2.0 mm		50	3911-180-T41-IM
230x2.5 mm		50	3911-230-T41-IM
115x1.0 mm		25	3912-115-T41-IM
125x1.0 mm		25	3912-125-T41-IM
125x1.0 mm		25	3911-1251T41-IM
180x1.6 mm		50	3911-1801T41-IM
230x1.9 mm		50	3911-2301T41-IM
230x3.0 mm		50	3911-2303T41-IM

Abrasive High-Performance Cutting Discs for Aluminium



391-T41_ALU

Ø	Ø	Quantity	Product Code
115 mm	22.23 mm	25	3911-115-T41-AL
125 mm	22.23 mm	25	3911-125-T41-AL

Abrasive High-Performance Cutting Discs for Inox



391-T41-I

Ø	Icons	Quantity	Product Code
115x1.0 mm		25	3911-115-T41-I
125x1.0 mm		25	3911-125-T41-I
150x1.0 mm		50	3911-150-T41-I
180x1.6 mm		50	3911-180-T41-I
230x1.9 mm		50	3911-230-T41-I

Abrasive High-Performance Cutting Discs for Stainless Steel & Metal



391-T41_CS

Ø	Ø	Quantity	Product Code
356 mm	25.4 mm	35	3911-350-X2TM
400 mm	25.4 mm	15	3911-400-F2TM
400 mm	25.4 mm	15	3911-400-X2TM

Abrasive High-Performance Cutting Discs for Metal



391-T42_M

Ø	Icons	Quantity	Product Code
115x2.5 mm		25	3911-115-T42-M
125x2.5 mm		25	3911-125-T42-M
150x2.5 mm		25	3911-150-T42-M
180x3.2 mm		25	3911-180-T42-M
230x3.2 mm		50	3911-230-T42-M

Abrasive High-Performance Cutting Discs for Building & Stone



391-T42_ST

Ø	Icons	Quantity	Product Code
115x3.2 mm		25	3912-115-T42-ST
125x3.2 mm		25	3912-125-T42-ST
180x3.2 mm		25	3912-180-T42-ST
230x3.2 mm		50	3912-230-T42-ST

Abrasive High-Performance Grinding Discs for Inox & Metal



392-T27_IM

Ø	Icons	Quantity	Product Code
115x6.4 mm		25	3921-115-T27-IM
125x6.4 mm		25	3921-125-T27-IM
150x6.4 mm		25	3921-150-T27-IM
180x6.5 mm		25	3921-180-T27-IM
230x6.5 mm		25	3921-230-T27-IM

Abrasive Conical Flap Grinding Discs for Inox & Metal



392-FLAP_C

Ø	Icons	Quantity	Product Code
115 mm		20	3926-115IM-C40
115 mm		20	3926-115IM-C60
115 mm		20	3926-115IM-C80
115 mm		20	3926-115IM-C120
125 mm		20	3926-125IM-C40
125 mm		20	3926-125IM-C60
125 mm		20	3926-125IM-C80
125 mm		20	3926-125IM-C120

Abrasive Flap Grinding Discs for Inox & Metal



392-FLAP_P

Ø	Icons	QTY	Model
115 mm		20	3927-115IM-P40
115 mm		20	3927-115IM-P60
115 mm		20	3927-115IM-P80
115 mm		20	3927-115IM-P120
125 mm		20	3927-125IM-P40
125 mm		20	3927-125IM-P60
125 mm		20	3927-125IM-P80
125 mm		20	3927-125IM-P120
125 mm		12	3927-125-40-3P
125 mm		12	3927-125-60-3P
125 mm		12	3927-125-80-3P
125 mm		12	3927-125-120-3P

Abrasive Diamond Cutting Discs for Ceramic & tiles



391-DIAM_C

Ø	Icons	QTY	Model
115 mm		100	3916-115-10P-CE
125 mm		100	3916-125-10P-CE
115 mm		100	3917-115-7S-C
125 mm		100	3917-125-7S-C

Abrasive Diamond Cutting Discs for General Purpose Stone



391-DIAM_U

Ø	Icons	QTY	Model
115 mm		100	3916-115-10S-UE
125 mm		100	3916-125-10S-UE
150 mm		50	3916-150-10S-UE

Ø	Icons	QTY	Model
180 mm		50	3916-180-10S-UE
230 mm		25	3916-230-10S-UE
115 mm		100	3917-115-7S-U
125 mm		100	3917-125-7S-U
230 mm		25	3917-230-7S-U

Abrasive Diamond Cutting Discs for Reinforced Concrete



391-DIAM_RC

Ø	Icons	QTY	Model
230 mm		25	3916-230-10L-RC

BANDSAW BLADES

Easy-Cut Bandsaw Blades with Portaband



3857 Easy-Cut Portaband

Icons	Material	QTY	Model
	S EZ	1	3857-13-0.6-EZ-S-3P690
	S EZ	1	3857-13-0.6-EZ-S-3P730
	S EZ	1	3857-13-0.6-EZ-S-3P835
	S EZ	1	3857-13-0.6-EZ-S-3P900
	S EZ	1	3857-13-0.6-EZ-S-3P1140
	M EZ	1	3857-13-0.6-EZ-M-3P690
	M EZ	1	3857-13-0.6-EZ-M-3P730
	M EZ	1	3857-13-0.6-EZ-M-3P835
	M EZ	1	3857-13-0.6-EZ-M-3P900
	M EZ	1	3857-13-0.6-EZ-M-3P1140

CARBIDE ROTARY BURRS

Tungsten Carbide Cylindrical Rotary Burrs for Metal



A

Ø	Icons	QTY	Model
3 mm		1	A0313M03
3 mm		1	A0313M03E
3 mm		1	A0313M03X
3 mm		1	A0313M03XE
3 mm		1	A0313M03XE-60
3 mm		1	A0313M03XE-80
6.3 mm		1	A0613M03X
6 mm		1	A0616M06
6 mm		1	A0616M06E
6 mm		1	A0616M06X
6 mm		1	A0616M06XE
8 mm		1	A0820M06
8 mm		1	A0820M06E
8 mm		1	A0820M06X
8 mm		1	A0820M06XE
10 mm		1	A1020M06
10 mm		1	A1020M06E
9.6 mm		1	A1020M06X
9.6 mm		1	A1020M06XE
12 mm		1	A1225M06
12.7 mm		1	A1225M06E
12 mm		1	A1225M06X
12.7 mm		1	A1225M08
12.7 mm		1	A1225M08E
12.7 mm		1	A1225M08X
16 mm		1	A1625M06
16 mm		1	A1625M06X
16 mm		1	A1625M06XE
16 mm		1	A1625M08
16 mm		1	A1625M08E
16 mm		1	A1625M08X
16 mm		1	A1625M08XE

* non stock standard



Tungsten Carbide Cylindrical Round Nose Rotary Burrs for Metal



C

3 mm	Medium		1	C0313M03
3 mm	Medium		1	C0313M03X
6.3 mm	Medium		1	C0616M03X
6 mm	Medium		1	C0616M06
6 mm	Medium		1	C0616M06X
8 mm	Medium		1	C0820M06
8 mm	Medium		1	C0820M06X
9.6 mm	Medium		1	C1020M06
10 mm	Medium		1	C1020M06X
12 mm	Medium		1	C1225M06
12 mm	Medium		1	C1225M06X
12.7 mm	Medium		1	C1225M08X
16 mm	Medium		1	C1625M06
16 mm	Medium		1	C1625M06X
16 mm	Medium		1	C1625M08
16 mm	Medium		1	C1625M08X

* non stock standard

Tungsten Carbide Oval Rotary Burrs for Metal



E

3 mm	Medium		1	E0308M03
3 mm	Medium		1	E0308M03X
6 mm	Medium		1	E0614M06
8 mm	Medium		1	E0816M06
8 mm	Medium		1	E0816M06X
9.6 mm	Medium		1	E1018M06
9.6 mm	Medium		1	E1018M06X
12.7 mm	Medium		1	E1222M06
12.7 mm	Medium		1	E1222M06X
12.7 mm	Medium		1	E1222M08
12.7 mm	Medium		1	E1222M08X
16 mm	Medium		1	E1625M06
16 mm	Medium		1	E1625M06X
16 mm	Medium		1	E1625M08
16 mm	Medium		1	E1625M08X

* non stock standard

Tungsten Carbide Arch Pointed Nose Rotary Burrs for Metal



G

3 mm	Medium		1	G0313M03
3 mm	Medium		1	G0313M03X
6.3 mm	Medium		1	G0613M03X
6 mm	Medium		1	G0618M06
6 mm	Medium		1	G0618M06X
8 mm	Medium		1	G0820M06
8 mm	Medium		1	G0820M06X
9.6 mm	Medium		1	G1020M06
9.6 mm	Medium		1	G1020M06X
12.7 mm	Medium		1	G1225M06
12.7 mm	Medium		1	G1225M06X
12 mm	Medium		1	G1225M08
12 mm	Medium		1	G1225M08X
16 mm	Medium		1	G1625M06
16 mm	Medium		1	G1625M06X
16 mm	Medium		1	G1625M08
16 mm	Medium		1	G1625M08X

* non stock standard

Tungsten Carbide Spherical Rotary Burrs for Metal



D

3 mm	Medium		1	D0303M03
3 mm	Medium		1	D0303M03X
6.3 mm	Medium		1	D0605M03X
6 mm	Medium		1	D0606M06
6 mm	Medium		1	D0606M06X
8 mm	Medium		1	D0807M06
8 mm	Medium		1	D0807M06X
9.6 mm	Medium		1	D1009M06
10 mm	M X		1	D1009M06X-69
9.6 mm	Medium		1	D1009M06X
12.7 mm	Medium		1	D1211M06
12.7 mm	Medium		1	D1211M06X
16 mm	Medium		1	D1614M06
16 mm	Medium		1	D1614M06X
16 mm	Medium		1	D1614M08
16 mm	Medium		1	D1614M08X

* non stock standard

Tungsten Carbide Arch Round Nose Rotary Burrs for Metal



F

3 mm	Medium		1	F0313M03
3 mm	Medium		1	F0313M03X
6.3 mm	Medium		1	F0613M03X
6 mm	Medium		1	F0618M06
6 mm	Medium		1	F0618M06X
8 mm	Medium		1	F0820M06
8 mm	Medium		1	F0820M06X
9.6 mm	Medium		1	F1020M06
9.6 mm	Medium		1	F1020M06X
12.7 mm	Medium		1	F1225M06
12.7 mm	Medium		1	F1225M06X
12.7 mm	Medium		1	F1225M08
12.7 mm	Medium		1	F1225M08X
16 mm	Medium		1	F1625M06
16 mm	Medium		1	F1625M06X
16 mm	Medium		1	F1625M08

* non stock standard

Tungsten Carbide Flame Rotary Burrs for Metal



H

6 mm	Medium		1	H0613M03X
10 mm	Medium		1	H1025M06
10 mm	Medium		1	H1025M06X
12.7 mm	Medium		1	H1232M06
12.7 mm	Medium		1	H1232M06X
16 mm	Medium		1	H1635M06X
16 mm	Medium		1	H1635M06
16 mm	Medium		1	H1635M08
16 mm	Medium		1	H1635M08X

* non stock standard

Tungsten Carbide 60° Cone Rotary Burrs for Metal



J

Ø	Texture	Profile	Part No.
6 mm	Medium	1	J0604M06
9.6 mm	Medium	1	J1010M06
12.7 mm	Medium	1	J1212M06
16 mm	Medium	1	J1616M06
16 mm	Medium	1	J1616M08

* non stock standard

Tungsten Carbide 90° Cone Rotary Burrs for Metal



K

Ø	Texture	Profile	Part No.
6 mm	Medium	1	K0602M06
9.6 mm	Medium	1	K1008M06
12.7 mm	Medium	1	K1210M06
16 mm	Medium	1	K1612M06
16 mm	Medium	1	K1612M08

* non stock standard

Tungsten Carbide Conical Round Nose Rotary Burrs for Metal



L

Ø	Texture	Profile	Part No.
10 mm	Medium	1	L1020M06
10 mm	Medium	1	L1020M06X
12.7 mm	Medium	1	L1225M06
12.7 mm	Medium	1	L1225M06X
12.7 mm	Medium	1	L1230M06
12.7 mm	Medium	1	L1230M06X
16 mm	Medium	1	L1630M06
16 mm	Medium	1	L1630M06X
16 mm	Medium	1	L1630M08
16 mm	Medium	1	L1630M08X

* non stock standard

Tungsten Carbide Conical Pointed Nose Rotary Burrs for Metal



M

Ø	Texture	Profile	Part No.
3 mm	Medium	1	M0310M03
3 mm	Medium	1	M0310M03X
6.3 mm	Medium	1	M0613M03X
6 mm	Medium	1	M0618M06
6 mm	Medium	1	M0618M06X
9.5 mm	Medium	1	M1022M06
9.5 mm	Medium	1	M1022M06X
12.7 mm	Medium	1	M1227M06
12.7 mm	Medium	1	M1227M06X
12.7 mm	Medium	1	M1227M08
16 mm	Medium	1	M1630M06
16 mm	Medium	1	M1630M06X
16 mm	Medium	1	M1630M08
16 mm	Medium	1	M1630M08X

* non stock standard

Tungsten Carbide Inverted Cone Nose Rotary Burrs for Metal



N

Ø	Texture	Profile	Part No.
3 mm	Medium	1	N0306M03
3 mm	Medium	1	N0306M03E
6 mm	Medium	1	N0607M06
12.7 mm	Medium	1	N1213M06
12.7 mm	Medium	1	N1213M06X
16 mm	Medium	1	N1613M06
16 mm	Medium	1	N1613M06X
16 mm	Medium	1	N1613M08

* non stock standard

Tungsten Carbide Cylindrical Nose Rotary Burrs for Aluminium



A-AL

Ø	Texture	Profile	Part No.
6 mm	AL	1	A0616AL06E
12.7 mm	AL	1	A1225AL06E
12.7 mm	AL	1	A1225AL08E
16 mm	AL	1	A1625AL08XE

Tungsten Carbide Cylindrical Round Nose Rotary Burrs for Aluminium



C-AL

Ø	Texture	Profile	Part No.
6 mm	AL	1	C0616AL06
12.7 mm	AL	1	C1225AL06

Tungsten Carbide Spherical Nose Rotary Burrs for Aluminium



D-AL

Ø	Texture	Profile	Part No.
12.7 mm	AL	1	D1211AL06
12.7 mm	AL	1	D1211AL08

* non stock standard



Tungsten Carbide Arch Round Nose Rotary Burrs for Aluminium



F-AL

6 mm		AL	1	F0618AL06
12.7 mm		AL	1	F1225AL06
12.7 mm		AL	1	F1225AL08

Tungsten Carbide Cylindrical Rotary Burrs for High Alloy Steel



A-S

6 mm		Steel	5	A0618S06E
9.6 mm		Steel	5	A1020S06
9.6 mm		Steel	5	A1020S06E
12.7 mm		Steel	5	A1225S06
12.7 mm		Steel	5	A1225S06E

Tungsten Carbide Arch Round Nose Rotary Burrs for High Alloy Steel



F-S

6 mm		Steel	5	F0618S06
9.6 mm		Steel	5	F1020S06
12.7 mm		Steel	5	F1225S06

Tungsten Carbide Conical Round Nose Rotary Burrs for Aluminium



L-AL

12.7 mm		AL	1	L1230AL06
12.7 mm		AL	1	L1230AL08

* non stock standard

Tungsten Carbide Cylindrical Round Nose Rotary Burrs for High Alloy Steel



C-S

6 mm		Steel	5	C0618S06
9.6 mm		Steel	5	C1020S06
12.7 mm		Steel	5	C1225S06

Tungsten Carbide Arch Pointed Nose Rotary Burrs for High Alloy Steel



G-S

9.6 mm		Steel	5	G1020S06
12.7 mm		Steel	5	G1225S06

Tungsten Carbide Cylindrical Rotary Special Burrs for Repairing Tyre



A/G

6 mm		TR	1	A0625M06X

* non stock standard

Tungsten Carbide Spherical Rotary Burrs for High Alloy Steel



D-S

6 mm		Steel	5	D0606S06
9.6 mm		Steel	5	D1010S06
12.7 mm		Steel	5	D1212S06

Tungsten Carbide Conical Round Nose Rotary Burrs for High Alloy Steel



L-S

9.6 mm		Steel	5	L1020S06
12.7 mm		Steel	5	L1228S06

Tungsten Carbide Cylindrical Rotary Burrs for Stainless Steel



A-I

Ø	Material	Qty	Part No.
3 mm	Inox	5	A0314I03
6 mm	Inox	5	A0618I06
9.6 mm	Inox	5	A1020I06
12.7 mm	Inox	5	A1225I06

Tungsten Carbide Oval Rotary Burrs for Stainless Steel



E-I

Ø	Material	Qty	Part No.
9.6 mm	Inox	5	E1015I06
12.7 mm	Inox	5	E1220I06

Tungsten Carbide Flame Rotary Burrs for Stainless Steel



H-I

Ø	Material	Qty	Part No.
9.6 mm	Inox	5	H1020I06
12.7 mm	Inox	5	H1232I06

Tungsten Carbide Cylindrical Round Nose Rotary Burrs for Stainless Steel



C-I

Ø	Material	Qty	Part No.
3 mm	Inox	5	C0312I03
6 mm	Inox	5	C0618I06
9.6 mm	Inox	5	C1020I06
12.7 mm	Inox	5	C1225I06

Tungsten Carbide Arch Round Nose Rotary Burrs for Stainless Steel



F-I

Ø	Material	Qty	Part No.
3 mm	Inox	5	F0312I03
6 mm	Inox	5	F0618I06
9.6 mm	Inox	5	F1020I06
12.7 mm	Inox	5	F1225I06

Tungsten Carbide Conical Round Nose Rotary Burrs for Stainless Steel



L-I

Ø	Material	Qty	Part No.
9.6 mm	Inox	5	L1020I06
12.7 mm	Inox	5	L1228I06

Tungsten Carbide Spherical Rotary Burrs for Stainless Steel



D-I

Ø	Material	Qty	Part No.
3 mm	Inox	5	D0303I03
6 mm	Inox	5	D0606I06
9.6 mm	Inox	5	D1010I06
12.7 mm	Inox	5	D1212I06

Tungsten Carbide Arch Pointed Nose Rotary Burrs for Stainless Steel



G-I

Ø	Material	Qty	Part No.
9.6 mm	Inox	5	G1020I06
12.7 mm	Inox	5	G1225I06

Tungsten Carbide Arch Pointed Nose Rotary Burrs for Tire Repair



TR

Ø	Material	Qty	Part No.
3 mm	Tire Repair	5	TR0325M03X-50
4.5 mm	Tire Repair	5	TR0636M06X-65
6 mm	Tire Repair	5	TR0650M06X-80
8 in	Tire Repair	5	TR0860M08X-110
8 mm	Tire Repair	5	TR4.530M06X-90



Tungsten Carbide Rotary Burrs Set for Metal 10 and 12 mm - 5 Pcs



ST-1-5P



5 376 g 1 RB-SET1-M06X-5P

A1020M06XE	
C1225M06X	
F1225M06X	
G1020M06X	
L1230M06X	

Tungsten Carbide Rotary Burrs Set for Metal 10 mm - 5 Pcs



ST-2-5P



5 313 g 1 RB-SET2-M06X-5P

A1020M06XE	
C1020M06X	
D1009M06X	
F1020M06X	
L1020M06X	

Tungsten Carbide Rotary Burrs Set for Metal - 10 Pcs



ST-10P



10 542 g 1 RB-SET-M06X-10P

A1020M06XE, A1225M06X	
C1020M06X, C1225M06X	
D1211M06X	
E1018M06X	
F1225M06X	
G1020M06X, G1225M06X	
L1230M06X	

Tungsten Carbide Rotary Burrs Set for Aluminium - 5 pcs



ALU-5P



5 380 g 1 RB-SET-AL06-5P

A1225AL06E	
C1225AL06	
D1211AL06	
F1225AL06	
L1230AL06	

DRILL BITS

SDS Max Drill Bits 4-cutter for Reinforced Concrete



4656

Ø	L		
12.0 mm	340 mm	1	4656-12-340
12.0 mm	540 mm	1	4656-12-540
14.0 mm	340 mm	1	4656-14-340
14.0 mm	540 mm	1	4656-14-540
15.0 mm	340 mm	1	4656-15-340
16.0 mm	340 mm	1	4656-16-340
16.0 mm	540 mm	1	4656-16-540
16.0 mm	940 mm	1	4656-16-940
16.0 mm	1320 mm	1	4656-16-1320
18.0 mm	340 mm	1	4656-18-340
18.0 mm	540 mm	1	4656-18-540

Ø	L		
18.0 mm	940 mm	1	4656-18-940
18.0 mm	1320 mm	1	4656-18-1320
20.0 mm	320 mm	1	4656-20-320
20.0 mm	520 mm	1	4656-20-520
20.0 mm	920 mm	1	4656-20-920
20.0 mm	1320 mm	1	4656-20-1320
22.0 mm	320 mm	1	4656-22-320
22.0 mm	520 mm	1	4656-22-520
22.0 mm	920 mm	1	4656-22-920
22.0 mm	1320 mm	1	4656-22-1320
24.0 mm	320 mm	1	4656-24-320
24.0 mm	520 mm	1	4656-24-520
25.0 mm	320 mm	1	4656-25-320
25.0 mm	520 mm	1	4656-25-520
25.0 mm	920 mm	1	4656-25-920
25.0 mm	1320 mm	1	4656-25-1320
26.0 mm	520 mm	1	4656-26-520
28.0 mm	370 mm	1	4656-28-370
28.0 mm	570 mm	1	4656-28-570
28.0 mm	670 mm	1	4656-28-670
28.0 mm	920 mm	1	4656-28-920
30.0 mm	370 mm	1	4656-30-370
30.0 mm	570 mm	1	4656-30-570
32.0 mm	370 mm	1	4656-32-370
32.0 mm	570 mm	1	4656-32-570
32.0 mm	920 mm	1	4656-32-920
32.0 mm	1320 mm	1	4656-32-1320
35.0 mm	370 mm	1	4656-35-370
35.0 mm	570 mm	1	4656-35-570
35.0 mm	670 mm	1	4656-35-670
37.0 mm	370 mm	1	4656-37-370
37.0 mm	570 mm	1	4656-37-570
37.0 mm	920 mm	1	4656-37-920
38.0 mm	370 mm	1	4656-38-370
38.0 mm	570 mm	1	4656-38-570
40.0 mm	370 mm	1	4656-40-370
40.0 mm	570 mm	1	4656-40-570
40.0 mm	920 mm	1	4656-40-920
40.0 mm	1320 mm	1	4656-40-1320
45.0 mm	570 mm	1	4656-45-570
45.0 mm	920 mm	1	4656-45-920
50.0 mm	570 mm	1	4656-50-570
52.0 mm	570 mm	1	4656-52-570

SDS+ Drill Bits 4-cutter for Reinforced Concrete



4651

Ø	L		
5.0 mm	115 mm	1	4651-5-110
5.0 mm	110 mm	1	4651-5-110-10P
5.0 mm	165 mm	1	4651-5-160
5.0 mm	160 mm	1	4651-5-160-10P
5.0 mm	265 mm	1	4651-5-260
5.5 mm	110 mm	10	4651-5.5-110-10P
5.5 mm	160 mm	1	4651-5.5-160-10P
5.5 mm	115 mm	1	4651-5.5-110
5.5 mm	165 mm	1	4651-5.5-160

Ø	L		
6.0 mm	115 mm	1	4651-6-110
6.0 mm	110 mm	1	4651-6-110-10P
6.0 mm	165 mm	1	4651-6-160
6.0 mm	160 mm	1	4651-6-160-10P
6.0 mm	215 mm	1	4651-6-210
6.0 mm	265 mm	1	4651-6-260
6.0 mm	315 mm	1	4651-6-310
6.5 mm	110 mm	50	4651-6,5-110
6.5 mm	165 mm	1	4651-6,5-160
6.5 mm	160 mm	1	4651-6,5-160-10P
6.5 mm	215 mm	1	4651-6,5-210
6.5 mm	265 mm	1	4651-6,5-260
6.5 mm	315 mm	1	4651-6,5-310
7.0 mm	115 mm	1	4651-7-110
7.0 mm	165 mm	1	4651-7-160
8.0 mm	115 mm	1	4651-8-110
8.0 mm	165 mm	1	4651-8-160
8.0 mm	160 mm	1	4651-8-160-10P
8.0 mm	215 mm	1	4651-8-210
8.0 mm	210 mm	1	4651-8-210-10P
8.0 mm	265 mm	1	4651-8-260
8.0 mm	315 mm	1	4651-8-310
8.0 mm	465 mm	1	4651-8-460
10.0 mm	115 mm	1	4651-10-110
10.0 mm	165 mm	1	4651-10-160
10.0 mm	160 mm	1	4651-10-160-10P
10.0 mm	215 mm	1	4651-10-210
10.0 mm	210 mm	1	4651-10-210-10P
10.0 mm	265 mm	1	4651-10-260
10.0 mm	315 mm	1	4651-10-310
10.0 mm	455 mm	1	4651-10-450
10.0 mm	600 mm	1	4651-10-600
10.0 mm	1000 mm	1	4651-10-1000
12.0 mm	160 mm	1	4651-12-160
12.0 mm	160 mm	1	4651-12-160-10P
12.0 mm	210 mm	1	4651-12-210
12.0 mm	210 mm	1	4651-12-210-10P
12.0 mm	260 mm	1	4651-12-260
12.0 mm	310 mm	1	4651-12-310
12.0 mm	450 mm	1	4651-12-450
12.0 mm	600 mm	1	4651-12-600
12.0 mm	1000 mm	1	4651-12-1000
14.0 mm	160 mm	1	4651-14-160
14.0 mm	210 mm	1	4651-14-210
14.0 mm	260 mm	1	4651-14-260
14.0 mm	310 mm	1	4651-14-310
14.0 mm	450 mm	1	4651-14-450
14.0 mm	600 mm	1	4651-14-600
14.0 mm	1000 mm	1	4651-14-1000
15.0 mm	160 mm	1	4651-15-160
15.0 mm	260 mm	1	4651-15-260
15.0 mm	450 mm	1	4651-15-450
16.0 mm	160 mm	1	4651-16-160
16.0 mm	210 mm	1	4651-16-210
16.0 mm	260 mm	1	4651-16-260
16.0 mm	310 mm	1	4651-16-310
16.0 mm	450 mm	1	4651-16-450
16.0 mm	600 mm	1	4651-16-600
16.0 mm	1000 mm	1	4651-16-1000
18.0 mm	250 mm	1	4651-18-250
18.0 mm	450 mm	1	4651-18-450
20.0 mm	250 mm	1	4651-20-250
20.0 mm	450 mm	1	4651-20-450
22.0 mm	250 mm	1	4651-22-250
22.0 mm	450 mm	1	4651-22-450
24.0 mm	250 mm	1	4651-24-250
24.0 mm	450 mm	1	4651-24-450
25.0 mm	250 mm	1	4651-25-250
25.0 mm	450 mm	1	4651-25-450
28.0 mm	250 mm	1	4651-28-250
28.0 mm	450 mm	1	4651-28-450
30.0 mm	250 mm	1	4651-30-250
30.0 mm	450 mm	1	4651-30-450
32.0 mm	450 mm	1	4651-32-450

Drill Set for Reinforced Concrete SDS + 4C - 5 pcs



4651-SET-5

Ø	L		
5		1	4651-SET-5

4651-5-110, 4651-6-110, 4651-6-160, 4651-8-160, 4651-10-160

Drill Set for Reinforced Concrete SDS + 4C - 7 pcs



4651-SET-7

Ø	L		
7		1	4651-SET-7

4651-5-110, 4651-6-110, 4651-8-110, 4651-6-160, 4651-8-160, 4651-10-160, 4651-12-160

SDS+ Drill Bits 2-cutter for Concrete



4652

Ø	L		
3.0 mm	110 mm	50	4652-3-110
3.5 mm	110 mm	50	4652-3,5-110
4.0 mm	110 mm	1	4652-4-110
4.0 mm	160 mm	1	4652-4-160
5.0 mm	110 mm	1	4652-5-110
5.0 mm	160 mm	1	4652-5-160
5.0 mm	110 mm	1	4652-5-110-10P
5.0 mm	160 mm	1	4652-5-160-10P
5.0 mm	210 mm	1	4652-5-210
5.5 mm	110 mm	1	4652-5,5-110
5.5 mm	110 mm	10	4652-5,5-110-10P
5.5 mm	160 mm	1	4652-5,5-160

Ø	L		
5.5 mm	160 mm	1	4652-5,5-160-10P
5.5 mm	210 mm	50	4652-5,5-210
6.0 mm	110 mm	1	4652-6-110
6.0 mm	110 mm	1	4652-6-110-10P
6.0 mm	160 mm	50	4652-6-160
6.0 mm	160 mm	1	4652-6-160-10P
6.0 mm	210 mm	1	4652-6-210
6.0 mm	260 mm	1	4652-6-260
6.5 mm	110 mm	1	4652-6,5-110
6.5 mm	160 mm	1	4652-6,5-160
6.5 mm	160 mm	1	4652-6,5-160-10P
7.0 mm	110 mm	1	4652-7-110
7.0 mm	160 mm	1	4652-7-160
8.0 mm	110 mm	1	4652-8-110
8.0 mm	160 mm	1	4652-8-160
8.0 mm	160 mm	1	4652-8-160-10P
8.0 mm	210 mm	1	4652-8-210
8.0 mm	210 mm	1	4652-8-210-10P
8.0 mm	260 mm	1	4652-8-260
8.0 mm	460 mm	1	4652-8-460
9.0 mm	160 mm	1	4652-9-160
9.0 mm	210 mm	1	4652-9-210
10.0 mm	110 mm	1	4652-10-110
10.0 mm	160 mm	1	4652-10-160
10.0 mm	160 mm	1	4652-10-160-10P
10.0 mm	210 mm	1	4652-10-210
10.0 mm	210 mm	1	4652-10-210-10P
10.0 mm	260 mm	1	4652-10-260
10.0 mm	310 mm	1	4652-10-310
10.0 mm	450 mm	1	4652-10-450
10.0 mm	600 mm	1	4652-10-600
11.0 mm	160 mm	1	4652-11-160
11.0 mm	260 mm	1	4652-11-260
12.0 mm	160 mm	1	4652-12-160
12.0 mm	160 mm	1	4652-12-160-10P
12.0 mm	210 mm	1	4652-12-210
12.0 mm	210 mm	1	4652-12-210-10P
12.0 mm	260 mm	1	4652-12-260
12.0 mm	310 mm	1	4652-12-310
12.0 mm	450 mm	1	4652-12-450
12.0 mm	600 mm	1	4652-12-600
12.0 mm	1000 mm	1	4652-12-1000
13.0 mm	310 mm	1	4652-13-310
14.0 mm	160 mm	1	4652-14-160
14.0 mm	210 mm	1	4652-14-210
14.0 mm	260 mm	1	4652-14-260
14.0 mm	310 mm	1	4652-14-310
14.0 mm	450 mm	1	4652-14-450
14.0 mm	600 mm	1	4652-14-600
14.0 mm	1000 mm	1	4652-14-1000
15.0 mm	260 mm	1	4652-15-260
16.0 mm	210 mm	1	4652-16-210
16.0 mm	260 mm	1	4652-16-260
16.0 mm	310 mm	1	4652-16-310
16.0 mm	450 mm	1	4652-16-450
16.0 mm	600 mm	1	4652-16-600
16.0 mm	1000 mm	1	4652-16-1000
18.0 mm	200 mm	1	4652-18-200
18.0 mm	300 mm	1	4652-18-300
18.0 mm	450 mm	1	4652-18-450
18.0 mm	1000 mm	1	4652-18-1000
20.0 mm	200 mm	1	4652-20-200
20.0 mm	300 mm	1	4652-20-300
20.0 mm	450 mm	1	4652-20-450
20.0 mm	600 mm	1	4652-20-600
20.0 mm	1000 mm	1	4652-20-1000
22.0 mm	250 mm	1	4652-22-250
22.0 mm	450 mm	1	4652-22-450
22.0 mm	600 mm	1	4652-22-600
22.0 mm	1000 mm	1	4652-22-1000
24.0 mm	250 mm	1	4652-24-250
24.0 mm	450 mm	1	4652-24-450
25.0 mm	250 mm	1	4652-25-250
25.0 mm	450 mm	1	4652-25-450
25.0 mm	1000 mm	1	4652-25-1000
26.0 mm	250 mm	1	4652-26-250
26.0 mm	450 mm	1	4652-26-450



Drill Set for Reinforced Concrete SDS + 2C - 5 pcs



4652-SET-5



5 1 4652-SET-5

4652-5-110, 4652-6-110, 4652-6-160, 4652-8-160, 4652-10-160

Drill Set for Reinforced Concrete SDS + 2C - 7 pcs



4652-SET-7



7 1 4652-SET-7

4652-5-110, 4652-6-110, 4652-8-110, 4652-6-160, 4652-8-160, 4652-10-160, 4652-12-160

Drill Bits for Concrete with Carbide Tip



4641



Ø	L	
3.0 mm	60 mm	1 4641-3-60
4.0 mm	75 mm	1 4641-4-75
5.0 mm	85 mm	1 4641-5-85

Ø	L	
5.0 mm	150 mm	1 4641-5-150
5.5 mm	85 mm	1 4641-5,5-85
6.0 mm	100 mm	1 4641-6-100
6.0 mm	150 mm	1 4641-6-150
6.0 mm	400 mm	1 4641-6-400
6.5 mm	100 mm	1 4641-6,5-100
7.0 mm	100 mm	1 4641-7-100
8.0 mm	120 mm	1 4641-8-120
8.0 mm	200 mm	1 4641-8-200
8.0 mm	400 mm	1 4641-8-400
9.0 mm	120 mm	1 4641-9-120
10.0 mm	120 mm	1 4641-10-120
10.0 mm	200 mm	1 4641-10-200
10.0 mm	400 mm	1 4641-10-400
10.0 mm	600 mm	1 4641-10-600
11.0 mm	150 mm	1 4641-11-150
12.0 mm	150 mm	1 4641-12-150
12.0 mm	200 mm	1 4641-12-200
12.0 mm	400 mm	1 4641-12-400
12.0 mm	600 mm	1 4641-12-600
13.0 mm	150 mm	1 4641-13-150
14.0 mm	150 mm	1 4641-14-150
14.0 mm	400 mm	1 4641-14-400
14.0 mm	600 mm	1 4641-14-600
16.0 mm	150 mm	1 4641-16-150
16.0 mm	400 mm	1 4641-16-400
16.0 mm	600 mm	1 4641-16-600
18.0 mm	400 mm	1 4641-18-400
18.0 mm	600 mm	1 4641-18-600
20.0 mm	400 mm	1 4641-20-400
20.0 mm	600 mm	1 4641-20-600
22.0 mm	400 mm	1 4641-22-400
24.0 mm	400 mm	1 4641-24-400
25.0 mm	400 mm	1 4641-25-400

Drill Set for Concrete with Carbide Tip - 5 Pcs



4641-PB

Icon X	g	Icon of drill bit and SDS bit
5	185 g	1 4641-PB

4641-4-75, 4641-5-85, 4641-6-100, 4641-8-120, 4641-10-120

Drill Set for Masonry with Carbide Tip - 5 pcs



4643-PB

Icon X	g	Icon of drill bit and SDS bit
5	150 g	1 4643-PB

4mm, 5mm, 6mm, 8mm and 10mm

SDS Max Chisel Drill Bits for Reinforced Concrete



4659

Ø	L	
- mm	280 mm	1 4659-POINT-28
- mm	400 mm	1 4659-POINT-40
- mm	600 mm	1 4659-POINT-60
24.0 mm	280 mm	1 4659-FLAT-28
24.0 mm	400 mm	1 4659-FLAT-40
24.0 mm	600 mm	1 4659-FLAT-60
80.0 mm	300 mm	1 4659-WIDE-30-8
50.0 mm	360 mm	1 4659-WIDE-36-5
50.0 mm	300 mm	1 4659-TILE-30-5
80.0 mm	300 mm	1 4659-TILE-30-8

SDS+ Chisel Drill Bits for Reinforced Concrete



4655

Ø	L	
20.0 mm	250 mm	1 4655-FLAT-250
22.0 mm	240 mm	1 4655-HOLLOW-240
- mm	250 mm	1 4655-POINT-250
32.0 mm	200 mm	1 4655-SLOT-25032
38.0 mm	200 mm	1 4655-TILE-20040
38.0 mm	200 mm	1 4655-WIDE-20040
22.0 mm	250 mm	1 4655-WING-C-250

Cobalt HSS-E Drill Bits for Metal



4411

Ø	L		
1.00 mm	34 mm	1	4411-1.00
1.50 mm	40 mm	1	4411-1.50
2.00 mm	49 mm	1	4411-2.00
2.50 mm	57 mm	1	4411-2.50
3.00 mm	61 mm	1	4411-3.00
3.25 mm	65 mm	1	4411-3.25
3.30 mm	65 mm	1	4411-3.30
3.50 mm	70 mm	1	4411-3.50
4.00 mm	75 mm	1	4411-4.00
4.20 mm	75 mm	1	4411-4.20
4.25 mm	75 mm	1	4411-4.25
4.50 mm	80 mm	1	4411-4.50
5.00 mm	86 mm	1	4411-5.00
5.50 mm	93 mm	1	4411-5.50
6.00 mm	93 mm	1	4411-6.00
6.50 mm	101 mm	1	4411-6.50
6.80 mm	109 mm	1	4411-6.80
7.00 mm	109 mm	1	4411-7.00
7.50 mm	109 mm	1	4411-7.50
8.00 mm	117 mm	1	4411-8.00
8.50 mm	117 mm	1	4411-8.50
9.00 mm	125 mm	1	4411-9.00
9.50 mm	125 mm	1	4411-9.50
10.00 mm	125 mm	1	4411-10.00
10.20 mm	133 mm	1	4411-10.20
10.50 mm	133 mm	1	4411-10.50
11.00 mm	142 mm	1	4411-11.00
11.50 mm	142 mm	1	4411-11.50
12.00 mm	151 mm	1	4411-12.00
12.50 mm	151 mm	1	4411-12.50
13.00 mm	151 mm	1	4411-13.00

Size 1 mm up to 4 mm, two drills in each tube

Cobalt HSS-E Drill Bits for Metal with Industrial Pack



4511

Ø	L		
0.50 mm	22 mm	1	4511-0.50-10P
0.75 mm	28 mm	1	4511-0.75-10P
1.00 mm	34 mm	1	4511-1.00-10P
1.50 mm	40 mm	1	4511-1.50-10P
1.75 mm	46 mm	1	4511-1.75-10P
2.00 mm	49 mm	1	4511-2.00-10P
2.50 mm	57 mm	1	4511-2.50-10P
2.70 mm	61 mm	1	4511-2.70-10P
2.90 mm	61 mm	1	4511-2.90-10P
3.00 mm	61 mm	1	4511-3.00-10P
3.10 mm	65 mm	1	4511-3.10-10P
3.25 mm	65 mm	1	4511-3.25-10P
3.30 mm	65 mm	1	4511-3.30-10P
3.50 mm	70 mm	1	4511-3.50-10P
3.80 mm	75 mm	1	4511-3.80-10P
4.00 mm	75 mm	1	4511-4.00-10P
4.20 mm	75 mm	1	4511-4.20-10P
4.50 mm	80 mm	1	4511-4.50-10P
4.80 mm	86 mm	1	4511-4.80-10P
5.00 mm	86 mm	1	4511-5.00-10P

Ø	L		
5.20 mm	86 mm	1	4511-5.20-10P
5.50 mm	93 mm	1	4511-5.50-10P
6.00 mm	93 mm	1	4511-6.00-10P
6.20 mm	101 mm	1	4511-6.20-10P
6.50 mm	101 mm	1	4511-6.50-10P
6.80 mm	109 mm	1	4511-6.80-10P
7.00 mm	109 mm	1	4511-7.00-10P
7.20 mm	109 mm	1	4511-7.20-10P
7.50 mm	109 mm	1	4511-7.50-10P
7.80 mm	117 mm	1	4511-7.80-10P
8.00 mm	117 mm	1	4511-8.00-10P
8.50 mm	117 mm	1	4511-8.50-10P
8.60 mm	125 mm	1	4511-8.60-10P
8.80 mm	125 mm	1	4511-8.80-10P
9.00 mm	125 mm	1	4511-9.00-10P
9.20 mm	125 mm	1	4511-9.20-10P
9.50 mm	125 mm	1	4511-9.50-10P
9.60 mm	133 mm	1	4511-9.60-10P
10.00 mm	133 mm	1	4511-10.00-5P
10.20 mm	133 mm	1	4511-10.20-5P
10.30 mm	133 mm	1	4511-10.30-5P
10.50 mm	133 mm	1	4511-10.50-5P
10.80 mm	142 mm	1	4511-10.80-5P
11.00 mm	142 mm	1	4511-11.00-5P
11.50 mm	142 mm	1	4511-11.50-5P
12.00 mm	151 mm	1	4511-12.00-5P
12.50 mm	151 mm	1	4511-12.50-5P
12.80 mm	151 mm	1	4511-12.80-5P
13.00 mm	151 mm	1	4511-13.00-5P
13.50 mm	160 mm	1	4511-13.50-1P
14.00 mm	160 mm	1	4511-14.00-1P
14.50 mm	169 mm	1	4511-14.50-1P
15.00 mm	169 mm	1	4511-15.00-1P
15.50 mm	169 mm	1	4511-15.50-1P
16.00 mm	178 mm	1	4511-16.00-1P
16.50 mm	184 mm	1	4511-16.50-1P
17.00 mm	184 mm	1	4511-17.00-1P
17.50 mm	191 mm	1	4511-17.50-1P
18.00 mm	191 mm	1	4511-18.00-1P
18.50 mm	198 mm	1	4511-18.50-1P
19.00 mm	198 mm	1	4511-19.00-1P
19.50 mm	205 mm	1	4511-19.50-1P
20.00 mm	205 mm	1	4511-20.00-1P

Cobalt HSS-E Drill Bit Set for Metal - 6 Pcs



4511-SET-6

X	g		
6	150 g	1	4511-SET-6

4411-2.00, 4411-3.00, 4411-4.00, 4411-5.00, 4411-6.00, 4411-8.00

Cobalt HSS-E Drill Bit Set for Metal - 19 Pcs



4511-SET-19

X	g		
19	600 g	1	4511-SET-19

1.0 to 10.0 mm x 0.5 mm

4411-1.00, 4411-1.50, 4411-2.00, 4411-2.50, 4411-3.00, 4411-3.50, 4411-4.00, 4411-4.50, 4411-5.00, 4411-5.50, 4411-6.00, 4411-6.50, 4411-7.00, 4411-7.50, 4411-8.00, 4411-8.50, 4411-9.00, 4411-9.50, 4411-10.00

Cobalt HSS-E Drill Bit Set for Metal - 25 Pcs



4511-SET-25

X	g		
25	1200 g	1	4511-SET-25

1x 1.0, 1.5; 2.0; 2.5; 3.0; 3.5; 4.0; 4.5; 5.0; 5.5; 6.0; 6.5; 7.0; 7.5; 8.0; 8.5; 9.0; 9.5; 10.0; 10.5; 11.0; 11.5; 12; 12.5; 13.0mm



HSS-G Drill Bits for Metal



4413



Ø	L		
1.00 mm	34 mm	1	4413-1.00
1.50 mm	40 mm	1	4413-1.50
2.00 mm	49 mm	1	4413-2.00
2.50 mm	57 mm	1	4413-2.50
3.00 mm	61 mm	1	4413-3.00
3.25 mm	65 mm	1	4413-3.25
3.30 mm	65 mm	1	4413-3.30
3.50 mm	70 mm	1	4413-3.50
4.00 mm	75 mm	1	4413-4.00
4.20 mm	75 mm	1	4413-4.20
4.25 mm	75 mm	1	4413-4.25
4.50 mm	80 mm	1	4413-4.50
5.00 mm	86 mm	1	4413-5.00
5.50 mm	93 mm	1	4413-5.50
6.00 mm	93 mm	1	4413-6.00
6.50 mm	101 mm	1	4413-6.50
6.80 mm	109 mm	1	4413-6.80
7.00 mm	109 mm	1	4413-7.00
7.50 mm	109 mm	1	4413-7.50
8.00 mm	117 mm	1	4413-8.00
8.50 mm	117 mm	1	4413-8.50
9.00 mm	125 mm	1	4413-9.00
9.50 mm	125 mm	1	4413-9.50
10.00 mm	133 mm	1	4413-10.00
10.20 mm	133 mm	1	4413-10.20
10.50 mm	133 mm	25	4413-10.50
11.00 mm	142 mm	1	4413-11.00
11.50 mm	142 mm	25	4413-11.50
12.00 mm	151 mm	1	4413-12.00
12.50 mm	151 mm	25	4413-12.50
13.00 mm	151 mm	1	4413-13.00

Size 1 mm up to 4 mm, two drills in each tube

HSS-G Drill Bits for Metal with Industrial Pack



4513

Ø	L		
1.00 mm	34 mm	1	4513-1.00-10P
1.50 mm	40 mm	1	4513-1.50-10P
1.75 mm	46 mm	1	4513-1.75-10P
2.00 mm	49 mm	1	4513-2.00-10P
2.50 mm	57 mm	1	4513-2.50-10P
2.70 mm	61 mm	1	4513-2.70-10P
2.90 mm	61 mm	1	4513-2.90-10P
3.00 mm	61 mm	1	4513-3.00-10P
3.10 mm	65 mm	1	4513-3.10-10P
3.25 mm	65 mm	1	4513-3.25-10P
3.30 mm	65 mm	1	4513-3.30-10P
3.50 mm	70 mm	1	4513-3.50-10P
3.80 mm	75 mm	1	4513-3.80-10P
4.00 mm	75 mm	1	4513-4.00-10P
4.20 mm	75 mm	1	4513-4.20-10P
4.50 mm	80 mm	1	4513-4.50-10P
4.80 mm	86 mm	1	4513-4.80-10P
5.00 mm	86 mm	1	4513-5.00-10P

Ø	L		
5.20 mm	86 mm	1	4513-5.20-10P
5.50 mm	93 mm	1	4513-5.50-10P
6.00 mm	93 mm	1	4513-6.00-10P
6.20 mm	101 mm	1	4513-6.20-10P
6.50 mm	101 mm	1	4513-6.50-10P
6.80 mm	109 mm	1	4513-6.80-10P
7.00 mm	109 mm	1	4513-7.00-10P
7.20 mm	109 mm	1	4513-7.20-10P
7.50 mm	109 mm	1	4513-7.50-10P
7.80 mm	117 mm	1	4513-7.80-10P
8.00 mm	117 mm	1	4513-8.00-10P
8.50 mm	117 mm	1	4513-8.50-10P
8.60 mm	125 mm	1	4513-8.60-10P
8.80 mm	125 mm	1	4513-8.80-10P
9.00 mm	125 mm	1	4513-9.00-10P
9.20 mm	125 mm	1	4513-9.20-10P
9.50 mm	125 mm	1	4513-9.50-10P
9.60 mm	133 mm	1	4513-9.60-10P
10.00 mm	133 mm	1	4513-10.00-5P
10.20 mm	133 mm	1	4513-10.20-5P
10.30 mm	133 mm	1	4513-10.30-5P
10.50 mm	133 mm	1	4513-10.50-5P
10.80 mm	142 mm	1	4513-10.80-5P
11.00 mm	142 mm	1	4513-11.00-5P
11.50 mm	142 mm	1	4513-11.50-5P
12.00 mm	151 mm	1	4513-12.00-5P
12.50 mm	151 mm	1	4513-12.50-5P
12.80 mm	151 mm	1	4513-12.80-5P
13.50 mm	160 mm	1	4513-13.50-1P
14.00 mm	160 mm	1	4513-14.00-1P
14.50 mm	169 mm	1	4513-14.50-1P
15.00 mm	169 mm	1	4513-15.00-1P
15.50 mm	178 mm	1	4513-15.50-1P
16.00 mm	178 mm	1	4513-16.00-1P
16.50 mm	184 mm	1	4513-16.50-1P
17.00 mm	184 mm	1	4513-17.00-1P
17.50 mm	191 mm	1	4513-17.50-1P
18.00 mm	191 mm	1	4513-18.00-1P
18.50 mm	198 mm	1	4513-18.50-1P
19.00 mm	198 mm	1	4513-19.00-1P
19.50 mm	205 mm	1	4513-19.50-1P

HSS-G Drill Bit Set for Metal - 6 Pcs



4513-SET-6

X	g		
6	150 g	1	4513-SET-6

2.0 to 8.0 mm x 1.0 mm (excl. 7.0 mm)

4413-2.00, 4413-3.00, 4413-4.00, 4413-5.00, 4413-6.00, 4413-8.00

HSS-G Drill Bit Set for Metal - 19 Pcs



4513-SET-19

X	g		
19	600 g	1	4513-SET-19

4413-1.00, 4413-1.50, 4413-2.00, 4413-2.50, 4413-3.00, 4413-3.50, 4413-4.00, 4413-4.50, 4413-5.00, 4413-5.50, 4413-6.00, 4413-6.50, 4413-7.00, 4413-7.50, 4413-8.00, 4413-8.50, 4413-9.00, 4413-9.50, 4413-10.00

HSS-G Drill Bit Set for Metal - 25 Pcs



4513-SET-25

X	g		
25	1200 g	1	4513-SET-25

1x 1.0, 1.5; 2.0; 2.5; 3.0; 3.5; 4.0; 4.5; 5.0; 5.5; 6.0; 6.5; 7.0; 7.5; 8.0; 8.5; 9.0; 9.5; 10.0; 10.5; 11.0; 11.5; 12; 12.5; 13.0 mm

HSS-R Drill Bits for Metal



4415



Ø	L		
1.00 mm	34 mm	1	4415-1.00
1.50 mm	40 mm	1	4415-1.50
2.00 mm	49 mm	1	4415-2.00
2.50 mm	57 mm	1	4415-2.50
3.00 mm	61 mm	1	4415-3.00
3.25 mm	65 mm	1	4415-3.25
3.50 mm	70 mm	1	4415-3.50
4.00 mm	75 mm	1	4415-4.00
4.25 mm	75 mm	1	4415-4.25
4.50 mm	80 mm	1	4415-4.50
5.00 mm	86 mm	1	4415-5.00
5.50 mm	93 mm	1	4415-5.50
6.00 mm	93 mm	1	4415-6.00
6.50 mm	101 mm	1	4415-6.50
7.00 mm	109 mm	1	4415-7.00
7.50 mm	109 mm	1	4415-7.50
8.00 mm	117 mm	1	4415-8.00
8.50 mm	117 mm	1	4415-8.50
9.00 mm	125 mm	1	4415-9.00
10.00 mm	125 mm	1	4415-10.00
10.50 mm	133 mm	1	4415-10.50
11.00 mm	142 mm	1	4415-11.00
11.50 mm	142 mm	1	4415-11.50
12.00 mm	151 mm	1	4415-12.00
12.50 mm	151 mm	1	4415-12.50
13.00 mm	151 mm	1	4415-13.00
13.50 mm	160 mm	1	4415-13.50
14.00 mm	160 mm	1	4415-14.00
14.50 mm	169 mm	1	4415-14.50
15.00 mm	169 mm	1	4415-15.00
15.50 mm	178 mm	1	4415-15.50
16.00 mm	178 mm	1	4415-16.00
16.50 mm	184 mm	1	4415-16.50
17.00 mm	184 mm	1	4415-17.00
17.50 mm	191 mm	1	4415-17.50
18.00 mm	191 mm	1	4415-18.00
18.50 mm	198 mm	1	4415-18.50
19.00 mm	198 mm	1	4415-19.00
19.50 mm	205 mm	1	4415-19.50
20.00 mm	205 mm	1	4415-20.00

Size 1 mm up to 4 mm, two drills in each tube

HSS-R Drill Bits for Metal with Industrial Pack



4515

Ø	L		
1.00 mm	34 mm	1	4515-1.00-10P
1.50 mm	40 mm	1	4515-1.50-10P
2.00 mm	49 mm	1	4515-2.00-10P
2.50 mm	57 mm	1	4515-2.50-10P
3.00 mm	61 mm	1	4515-3.00-10P
3.25 mm	65 mm	1	4515-3.25-10P
3.50 mm	70 mm	1	4515-3.50-10P
4.00 mm	75 mm	1	4515-4.00-10P
4.25 mm	75 mm	1	4515-4.25-10P
4.50 mm	80 mm	1	4515-4.50-10P
5.00 mm	86 mm	1	4515-5.00-10P

Ø	L		
5.50 mm	93 mm	1	4515-5.50-10P
6.00 mm	93 mm	1	4515-6.00-10P
6.50 mm	101 mm	1	4515-6.50-10P
7.00 mm	109 mm	1	4515-7.00-10P
7.50 mm	109 mm	1	4515-7.50-10P
8.00 mm	117 mm	1	4515-8.00-10P
8.50 mm	117 mm	1	4515-8.50-10P
9.00 mm	125 mm	1	4515-9.00-10P
9.50 mm	125 mm	1	4515-9.50-10P
10.00 mm	133 mm	1	4515-10.00-10P
10.50 mm	133 mm	1	4515-10.50-5P
11.00 mm	142 mm	1	4515-11.00-5P
11.50 mm	142 mm	1	4515-11.50-5P
12.00 mm	151 mm	1	4515-12.00-5P
12.50 mm	151 mm	1	4515-12.50-5P
13.00 mm	151 mm	1	4515-13.00-5P

HSS-R Drill Bit Set for Metal - 19 Pcs



4515-SET-19



X	g		
19	600 g	1	4515-SET-19

1x 1.0mm; 1.5mm; 2.0mm; 2.5mm; 3.0mm; 3.5mm; 4.0mm; 4.5mm; 5.0mm; 5.5mm; 6.0mm; 6.5mm; 7mm; 7.5mm; 8mm; 8.5mm; 9.0mm; 9.5mm; 10mm

HSS-R Drill Bit Set for Metal - 25 pcs



4515-SET-25



X	g		
25	1200 g	1	4515-SET-25

1x 1.0; 1.5; 2.0; 2.5; 3.0; 3.5; 4.0; 4.5; 5.0; 5.5; 6.0; 6.5; 7; 7.5; 8; 8.5; 9.0; 9.5; 10; 10.5; 11; 11.5; 12; 12.5; 13 mm

Step Drills for Metal Sheet 4 mm-12 mm



228-SD

6.35 mm	4-5-6-7-8-9-10-11-12 mm	24	228-SD

Step Drills for Metal sheet 4 mm-22 mm



229-SD

10 mm	4-6-8-10-12-14-16-18-20-22 mm	24	229-SD

Step Drills for Metal sheet 5 mm-35 mm



230-SD

12.7 mm	5-13-15-17-19-21-23-25-27-29-31-33-35 mm	25	230-SD



Step Drills for Metal Sheet 6 mm-37 mm



232-SD

10 mm	6-9-12.5-15.2-18.6-20.4-22.5-26-28.3-30.5-34-37 mm	1	232-SD

Step Drills for Metal Sheet 6.5 mm-40.5 mm



234-SD

10 mm	6.5-8.5-10.5-12.5-16.5-20.5-25.5-29-32.5-36.5-40.5 mm	25	234-SD

HSS Step Drill Set - 3 Pcs



228-SET

3	560 g	1	228-SET-SD

228-SD	
229-SD	
230-SD	

HSS-G Countersink Drill Bits for Metal



4435

12.4 mm	56 mm	1	4435-12.4

Installer Drill Bits for Wood



9666

6 mm	400 mm	1	9666-6-400
6 mm	600 mm	1	9666-6-600
8 mm	400 mm	1	9666-8-400
8 mm	600 mm	1	9666-8-600
10 mm	400 mm	1	9666-10-400
10 mm	600 mm	1	9666-10-600
12 mm	400 mm	1	9666-12-400
12 mm	600 mm	1	9666-12-600
14 mm	400 mm	1	9666-14-400
14 mm	600 mm	1	9666-14-600
16 mm	400 mm	1	9666-16-400
16 mm	600 mm	1	9666-16-600
20 mm	400 mm	1	9666-20-400
20 mm	600 mm	1	9666-20-600
22 mm	400 mm	1	9666-22-400
22 mm	600 mm	1	9666-22-600

Auger Drill Bits for Wood



9626

6.0 mm		1	9626-6
7.0 mm		1	9626-7
8.0 mm		1	9626-8
9.0 mm		1	9626-9
10.0 mm		1	9626-10
11.0 mm		1	9626-11
12.0 mm		1	9626-12
13.0 mm		1	9626-13
14.0 mm		1	9626-14
15.0 mm		1	9626-15
16.0 mm		1	9626-16
18.0 mm		1	9626-18
20.0 mm		1	9626-20
22.0 mm		1	9626-22
23.0 mm		1	9626-23
24.0 mm		1	9626-24
25.0 mm		1	9626-25
26.0 mm		1	9626-26
28.0 mm		1	9626-28
30.0 mm		1	9626-30
32.0 mm		1	9626-32
35.0 mm		1	9626-35
6.0 mm		1	9627-6-460
8.0 mm		1	9627-8-460
10.0 mm		1	9627-10-460
12.0 mm		1	9627-12-460
14.0 mm		1	9627-14-460
16.0 mm		1	9627-16-460
18.0 mm		1	9627-18-460
20.0 mm		1	9627-20-460
22.0 mm		1	9627-22-460
24.0 mm		1	9627-24-460
26.0 mm		1	9627-26-460
28.0 mm		1	9627-28-460
30.0 mm		1	9627-30-460
32.0 mm		1	9627-32-460

Auger Bit Set - 6 Pcs



SB-9526/S6

6		20	SB-9526/S6

9526-10, 9526-13, 9526-19, 9526-22, 9526-25
9526-16

Flat Drill Bits for Wood



9629

Ø	L		
6.0 mm	152 mm	1	9629-6
8.0 mm	152 mm	1	9629-8
10.0 mm	152 mm	1	9629-10
12.0 mm	152 mm	1	9629-12
13.0 mm	152 mm	1	9629-13
14.0 mm	152 mm	1	9629-14
16.0 mm	152 mm	1	9629-16
17.0 mm	152 mm	1	9629-17
18.0 mm	152 mm	1	9629-18
19.0 mm	152 mm	1	9629-19
20.0 mm	152 mm	1	9629-20
22.0 mm	152 mm	1	9629-22
24.0 mm	152 mm	1	9629-24
25.0 mm	152 mm	1	9629-25
26.0 mm	152 mm	1	9629-26
28.0 mm	152 mm	1	9629-28
30.0 mm	152 mm	1	9629-30
32.0 mm	152 mm	1	9629-32
35.0 mm	152 mm	1	9629-35
36.0 mm	152 mm	1	9629-36
38.0 mm	152 mm	1	9629-38
40.0 mm	152 mm	1	9629-40
6.0 mm	400 mm	1	9631-6-400
8.0 mm	400 mm	1	9631-8-400
10.0 mm	400 mm	1	9631-10-400
12.0 mm	400 mm	1	9631-12-400
13.0 mm	400 mm	1	9631-13-400
14.0 mm	400 mm	1	9631-14-400
16.0 mm	400 mm	1	9631-16-400
18.0 mm	400 mm	1	9631-18-400
19.0 mm	400 mm	1	9631-19-400
20.0 mm	400 mm	1	9631-20-400
22.0 mm	400 mm	1	9631-22-400
24.0 mm	400 mm	1	9631-24-400
25.0 mm	400 mm	1	9631-25-400
28.0 mm	400 mm	1	9631-28-400
30.0 mm	400 mm	1	9631-30-400
32.0 mm	400 mm	1	9631-32-400
35.0 mm	400 mm	1	9631-35-400
38.0 mm	400 mm	1	9631-38-400

Flat Drill Bit Set for Wood - 8 pcs



9629-SET-8

X	g		
8	630 g	12	9629-SET-8

9629-12, 9629-16, 9629-18, 9629-20, 9629-22, 9629-25, 9629-28, 9629-32



Speed Cut Drill Bit Set for Wood - 6 Pcs



9656-SET-6

X	g		
6	720 g	1	9656-SET-6

Brad Point Drill Bits for Wood



9646

Ø	L		
3 mm		1	9646-3
4 mm		1	9646-4
5 mm		1	9646-5
6 mm		1	9646-6
7 mm		1	9646-7
8 mm		1	9646-8
9 mm		1	9646-9
10 mm		1	9646-10
11 mm		1	9646-11
12 mm		1	9646-12
13 mm		1	9646-13
14 mm		1	9646-14
15 mm		1	9646-15
16 mm		1	9646-16
18 mm		1	9646-18
20 mm		1	9646-20
6 mm		1	9646-6-250
8 mm		1	9646-8-250
10 mm		1	9646-10-250
12 mm		1	9646-12-250

Brad Point Drill Bit Set for Wood - 5 pcs



9646-SET-5

X	g		
5	110 g	1	9646-SET-5

9646-4, 9646-5, 9646-6, 9646-8, 9646-10



Brad Point Drill Bit Set for Wood - 8 pcs



9646-SET-8

X	g		
8	230 g	1	9646-SET-8

9646-3, 9646-4, 9646-5, 9646-6, 9646-7, 9646-8, 9646-9, 9646-10



Drill Bits for Tiles



4626

Ø	L		
4 mm	58 mm	1	4626-4.0
5 mm	58 mm	1	4626-5.0
6 mm	58 mm	1	4626-6.0
8 mm	78 mm	1	4626-8.0
10 mm	98 mm	1	4626-10.0



Multi-Purpose Drill Bits for Tiles, Natural Stone, Wood and Plastic



4629

Ø	L	Icons	Part No.
4.0 mm	75 mm		1 4629-4.0
5.0 mm	85 mm		1 4629-5.0
6.0 mm	100 mm		1 4629-6.0
8.0 mm	120 mm		1 4629-8.0
10.0 mm	120 mm		1 4629-10.0

Drill Set Multi-Purpose with Carbide Tip - 5 pcs



4629-SET-5

Icons	Weight	Quantity	Part No.
	165 g	5	4629-SET-5

4629-8.0, 4629-10.0, 4629-4.0, 4629-5.0, 4629-6.0

Extension Shaft 305 mm 1/4" Quick-Change



9625-6.35QC

Ø	L	Quantity	Part No.
6.35 mm	305 mm	1	9625-6.35QC

Extension Shafts 330 mm



9525

Ø	Quantity	Part No.
7 mm	1	9525-7
10 mm	1	9525-10

SCREWDRIVER BITS

1/4" Diamond Torsion Screwdriver Bits for Phillips Head Screws 25 mm



63D/PH

Icons	Quantity	Part No.
	5	63D/PH3

1/4" Diamond Torsion Screwdriver Bits for Pozidriv Head Screws 25 mm



63D/PZ

Icons	Quantity	Part No.
	5	63D/PZ1
	5	63D/PZ2

1/4" Diamond Torsion Screwdriver Bits for TORX® Head Screws 25 mm



63D/T

Icons	Quantity	Part No.
	5	63D/T10
	5	63D/T15
	5	63D/T40

1/4" Diamond Torsion Screwdriver Bits for Pozidriv Head Screws 50 mm - 5 Pcs/ Plastic Box



63D/50PZ

Icons	Quantity	Part No.
	5	63D/50PZ1
	5	63D/50PZ2
	5	63D/50PZ3

1/4" Diamond Torsion Screwdriver Bits Set with Bit Holder for Phillips/Pozidriv/TORX® Head Screws



63D/7

Icons	Dimensions	Quantity	Part No.
	20 x 50 x 80 mm	7	63D/7-1

63D/PH2

63D/PZ2

63D/T10, 63D/T15, 63D/T25, 63D/T30

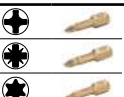

1/4" Tin Torsion Screwdriver Bits for Phillips Head Screws 25 mm



62TIN/PH

10	1	1	62TIN/PH1

1/4" Tin Torsion Screwdriver Bits for Phillips Head Screws 50 mm



62TIN/50PH

5	1	1	62TIN/50PH1
5	3	1	62TIN/50PH3

1/4" ACR Torsion Screwdriver Bits for Phillips Head Screws 25 mm



64A/PH

10	1	1	64A/PH1
10	3	1	64A/PH3

1/4" Tin Torsion Screwdriver Bits for Pozidriv Head Screws 25 mm



62TIN/PZ

10	1	1	62TIN/PZ1
10	2	1	62TIN/PZ2
10	3	1	62TIN/PZ3

1/4" Tin Torsion Screwdriver Bits for Pozidriv Head Screws 50 mm



62TIN/50PZ

5	1	1	62TIN/50PZ1
5	2	1	62TIN/50PZ2
5	3	1	62TIN/50PZ3

1/4" ACR Torsion Screwdriver Bits for Pozidriv Head Screws 25 mm



64A/PZ

10	1	1	64A/PZ1
10	3	1	64A/PZ3

1/4" Tin Torsion Screwdriver Bits for TORX® Head Screws 25 mm



62TIN/T

10	T15	1	62TIN/T15
10	T20	1	62TIN/T20
10	T25	1	62TIN/T25
10	T30	1	62TIN/T30

1/4" Tin Torsion Bit Set for Phillips/Pozidriv/TORX® Head Screws



62TIN/7

7	22 x 65 x 75 mm	1	62TIN/7-1

62TIN/PH2



62TIN/PZ2



62TIN/T15, 62TIN/T20, 62TIN/T25, 62TIN/T30



1/4" Torsion Screwdriver Bits for Phillips Head Screws 25 mm



60T/PH

10	1	1	60T/PH1
10	2	1	60T/PH2
10	3	1	60T/PH3



1/4" Torsion Screwdriver Bits for Pozidriv Head Screws 25 mm



60T/PZ

10	3	1	60T/PZ3



1/4" Torsion Bit Set for Phillips/TORX® head screws - 17 Pcs



60T/17

17	27 x 73 x 82 mm	1 60T/17-1



1/4" Extra Hard Torsion Screwdriver Bits for Pozidriv Head Screws 25 mm



61H/PZ

5	3	1	61H/PZ3



1/4" Torsion Screwdriver Bits for TORX® Head Screws 25 mm



60T/T

10	T7	1	60T/T7
10	T9	1	60T/T9
10	T15	1	60T/T15
10	T20	1	60T/T20
10	T25	1	60T/T25
10	T27	1	60T/T27
10	T40	1	60T/T40



1/4" Extra Hard Torsion Screwdriver Bits for Phillips Head Screws 25 mm



61H/PH

10	2	1	61H/PH2
5	3	1	61H/PH3



1/4" Extra Hard Torsion Screwdriver Bits for Pozidriv Head Screws 50 mm



61H/50PZ

5	1	1	61H/50PZ1
5	3	1	61H/50PZ3



1/4" Torsion Bit Set for Phillips/Pozidriv/TORX® head screws - 7 Pcs



60T/7

7	22 x 65 x 75 mm	1 60T/7-1



1/4" Extra Hard Torsion Screwdriver Bits for Phillips Head Screws 50 mm



61H/50PH

5	1	1	61H/50PH1



1/4" Extra Hard Torsion Screwdriver Bits for TORX® Head Screws 50 mm



61H/50T

5	T10	1	61H/50T10
5	T15	1	61H/50T15
5	T25	1	61H/50T25



1/4" Extra Hard Torsion Screwdriver Bits for TORX® Head Screws 25 mm



61H/T

10	T10	1	61H/T10
10	T15	1	61H/T15
10	T20	1	61H/T20
10	T25	1	61H/T25
5	T40	1	61H/T40



1/4" Heavy-Duty Torsion Screwdriver Bits for TORX® Screws 25 mm



66IM/T

10	T10	50	66IM/T10C-10P
10	T15	50	66IM/T15C-10P
10	T20	50	66IM/T20C-10P
25	T20	25	66IM/T20C-25P
10	T25	50	66IM/T25C-10P
25	T25	25	66IM/T25C-25P
10	T27	50	66IM/T27C-10P
10	T30	50	66IM/T30C-10P
25	T30	25	66IM/T30C-25P
10	T40	50	66IM/T40C-10P
2	T10	80	66IM/T10C-2P
2	T15	80	66IM/T15C-2P
2	T20	80	66IM/T20C-2P
2	T25	80	66IM/T25C-2P
2	T27	80	66IM/T27C-2P
2	T20	80	66IM/T30C-2P
2	T40	80	66IM/T40C-2P



1/4" Heavy-Duty Torsion Screwdriver Bits for Pozidriv Screws 50 mm



66IM/50PZ

10	1	50	66IM/50PZ1-10P
10	2	50	66IM/50PZ2-10P
10	3	50	66IM/50PZ3-10P
2	1	80	66IM/50PZ1-2P
2	2	80	66IM/50PZ2-2P
2	3	80	66IM/50PZ3-2P



1/4" Heavy-Duty Torsion Screwdriver Bits for Phillips Screws 25 mm



66IM/PH

10	1	50	66IM/PH1-10P
10	2	50	66IM/PH2-10P
25	2	25	66IM/PH2-25P
10	3	50	66IM/PH3-10P
2	1	80	66IM/PH1-2P
2	2	80	66IM/PH2-2P
2	3	80	66IM/PH3-2P



1/4" Heavy-Duty Torsion Screwdriver Bits for Phillips Screws 50 mm



66IM/50PH

10	1	50	66IM/50PH1-10P
10	2	50	66IM/50PH2-10P
10	3	50	66IM/50PH3-10P
2	1	80	66IM/50PH1-2P
2	2	80	66IM/50PH2-2P
2	3	80	66IM/50PH3-2P



1/4" Heavy-Duty Torsion Screwdriver Bits for Pozidriv Screws 25 mm



66IM/PZ

10	1	50	66IM/PZ1-10P
10	2	50	66IM/PZ2-10P
25	2	25	66IM/PZ2-25P
10	3	50	66IM/PZ3-10P
2	1	80	66IM/PZ1-2P
2	2	80	66IM/PZ2-2P
2	3	80	66IM/PZ3-2P



66IM/50TC

10	T10	50	66IM/50T10C-10P
10	T15	50	66IM/50T15C-10P
10	T20	50	66IM/50T20C-10P
10	T25	50	66IM/50T25C-10P
10	T27	50	66IM/50T27C-10P
10	T30	50	66IM/50T30C-10P
10	T40	50	66IM/50T40C-10P
2	10	80	66IM/50T10C-2P
2	15	80	66IM/50T15C-2P
2	20	80	66IM/50T20C-2P
2	25	80	66IM/50T25C-2P
2	27	80	66IM/50T27C-2P
2	30	80	66IM/50T30C-2P
2	40	80	66IM/50T40C-2P



1/4" Impact Torsion Screwdriver Bits for Phillips Screws 90 mm



66IM/90PH

2	2	40	66IM/90PH2-2P
2	3	40	66IM/90PH3-2P

1/4" Impact Torsion Screwdriver Bits for Phillips Screws 150 mm



66IM/150PH

2	2	40	66IM/150PH2-2P

1/4" Impact Torsion Hex Head Magnetic Nut Drivers



66IM/M50

1	20	66IM/M50-10-1P
1	20	66IM/M50-11-1P
1	20	66IM/M50-13-1P
1	20	66IM/M50-6-1P
1	20	66IM/M50-7-1P
1	20	66IM/M50-8-1P

1/4" Impact Torsion Screwdriver Bits for Pozidriv Screws 90 mm



66IM/90PZ

2	2	40	66IM/90PZ2-2P
2	3	40	66IM/90PZ3-2P

1/4" Impact Torsion Screwdriver Bits for Pozidriv Screws 150 mm



66IM/150PZ

2	2	40	66IM/150PZ2-2P

1/4" Impact Torsion Hex Universal Magnetic Bit Holders



66IM/KM

1	20	66IM/KM150-1P
1	20	66IM/KM300-1P
1	20	66IM/KM75-1P

1/4" Impact Torsion Screwdriver Bits for TORX® Screws 90 mm



66IM/90TC

2	T15	40	66IM/90T15C-2P
2	T20	40	66IM/90T20C-2P
2	T25	40	66IM/90T25C-2P
2	T30	40	66IM/90T30C-2P
2	T40	40	66IM/90T40C-2P

1/4" Impact Torsion Screwdriver Bits for TORX® Screws 150 mm



66IM/150TC

2	T20	40	66IM/150T20C-2P
2	T25	40	66IM/150T25C-2P
2	T30	40	66IM/150T30C-2P
2	T40	40	66IM/150T40C-2P

1/4" Impact Torsion Hex Universal Magnetic Bit Holders with Quick Release



66IM/KMQR

1	20	66IM/KM75QR-1P

1/4" Impact Torsion Hex Drive Socket Adaptor 50 mm



66IM/K



X		IMPACT	
1	20	66IM/K50-1/2-1P	
1	20	66IM/K50-1/4-1P	
1	20	66IM/K50-3/8-1P	

1/4" Heavy-Duty Torsion Bit Set for Phillips/Pozidriv/TORX® with Soft Plastic Holder - 11 Pcs



66IM/11C-1



X		IMPACT	
11	25 x 37 x 140 mm	40	66IM/11C-1

66IM/PH2-2Px 2, 66IM/PH3-2P		
66IM/PZ2-2Px 2, 66IM/PZ3-2P		
66IM/T20C-2Px 2, 66IM/T25C-2P, 66IM/T30C-2P		
KMT753-QR-1P		

1/4" Heavy-Duty Torsion Bit Set for Phillips/Pozidriv/TORX® with Soft Plastic Holder - 10 Pcs



66IM/10C-1



X		IMPACT	
10	10 x 50 x 140 mm	40	66IM/10C-1

66IM/50PH2-2Px 2, 66IM/50PH3-2P		
66IM/50PZ2-2Px 2, 66IM/50PZ3-2P		
66IM/50T20C-2Px 2, 66IM/50T25C-2P, 66IM/50T30C-2P		

1/4" Impact Torsion Bit Set for Slotted/Phillips/Pozidriv/TORX®/Hex Screws - 31 Pcs



66IM/31C-1

X		IMPACT	
31	42 x 65 x 110 mm	6	66IM/31C-1

66IM/PH1-2P, 66IM/PH2-2Px 3, 66IM/PH3-2P		
66IM/PZ1-2P, 66IM/PZ2-2Px 3, 66IM/PZ3-2P		
66IM/T10C-2P, 66IM/T15C-2Px 3, 66IM/T20C-2Px 3, 66IM/T25C-2Px 2, 66IM/T27C-2P, 66IM/T30C-2Px 2		
66IM/KM75QR-1P		

1/4" Impact Torsion Bit Set for Phillips/Pozidriv/TORX®/Hex Head Screws - 40 Pcs



66IM/40C-1

X		IMPACT	
40	45 x 105 x 175 mm	10	66IM/40C-1

66IM/PZ2-2P		
66IM/T10C-2P, 66IM/T15C-2P, 66IM/T20C-2P, 66IM/T25C-2P, 66IM/T30C-2P		
66IM/50PH1-2P, 66IM/50PH2-2P, 66IM/50PH3-2P		
66IM/50PZ1-2P, 66IM/50PZ2-2P, 66IM/50PZ3-2P		
66IM/50T10C-2P, 66IM/50T15C-2P, 66IM/50T20C-2P, 66IM/50T25C-2P, 66IM/50T27C-2P, 66IM/50T30C-2P, 66IM/50T40C-2P		
66IM/90T15C-2P, 66IM/90T20C-2P, 66IM/90T25C-2P, 66IM/90T30C-2P, 66IM/90T40C-2P		
66IM/KM75QR-1P		
66IM/K50-1/4-1P		
66IM/M50-8-1P, 66IM/M50-10-1P, 66IM/M50-11-1P, 66IM/M50-13-1P		

1/4" Standard Screwdriver Bits for Slotted Head Screws 25 mm



59S/

X		IMPACT	
3	3.0 mm	50	59S/0.5-3.0-3P
10	4.0 mm	1	59S/0.5-4.0
3	4.0 mm	50	59S/0.5-4.0-3P
10	3.5 mm	1	59S/0.6-3.5
3	3.5 mm	50	59S/0.6-3.5-3P
10	4.5 mm	1	59S/0.6-4.5
3	4.5 mm	1	59S/0.6-4.5-3P
10	5.5 mm	1	59S/0.8-5.5
3	5.5 mm	1	59S/0.8-5.5-3P
10	5.5 mm	1	59S/1.0-5.5
3	5.5 mm	50	59S/1.0-5.5-3P
10	6.5 mm	1	59S/1.2-6.5
3	6.5 mm	50	59S/1.2-6.5-3P
10	8.0 mm	1	59S/1.2-8.0
3	8.0 mm	1	59S/1.2-8.0-3P
10	9.0 mm	1	59S/1.6-9.0
10	10 mm	1	59S/1.6-10
3	9.0 mm	50	59S/1.6-9.0-3P
3	10.0 mm	50	59S/1.6-10-3P

1/4" Standard Screwdriver Bit for Phillips Head Screws 25 mm



59S/PH

X		IMPACT	
10	0	1	59S/PH0
3	0	50	59S/PH0-3P
10	1	50	59S/PH1-10P
3	1	1	59S/PH1-3P
30	1	1	59S/PH1-30P
100	*1	100	59S/PH1-IP
500	1	500	59S/PH1-IPB
10	2	50	59S/PH2-10P
3	2	1	59S/PH2-3P
30	2	1	59S/PH2-30P
100	*2	100	59S/PH2-IP
500	*2	500	59S/PH2-IPB
10	3	50	59S/PH3-10P
3	3	1	59S/PH3-3P
30	3	1	59S/PH3-30P
500	3	500	59S/PH3-IPB
10	4	1	59S/PH4
3	4	25	59S/PH4-3P



1/4" Standard Screwdriver Bits for Phillips Dry Wall Head Screws 25 mm



59S/PH2G

Quantity	Bit Type	Quantity	Part Number
10	2G	50	59S/PH2G-10P
3	PH2G	50	59S/PH2G-3P
30	PH2G	1	59S/PH2G-30P

1/4" Standard Screwdriver Bit for Pozidriv Head Screws 25 mm



59S/PZ

Quantity	Bit Type	Quantity	Part Number
3	0	50	59S/PZ0-3P
10	1	50	59S/PZ1-10P
3	1	1	59S/PZ1-3P
30	1	1	59S/PZ1-30P
100	*1	100	59S/PZ1-1P
500	*1	500	59S/PZ1-1PB
10	2	50	59S/PZ2-10P
3	2	1	59S/PZ2-3P
30	2	1	59S/PZ2-30P
100	*2	100	59S/PZ2-1P
500	*2	500	59S/PZ2-1PB
10	3	50	59S/PZ3-10P
3	3	1	59S/PZ3-3P
30	3	1	59S/PZ3-30P
500	3	500	59S/PZ3-1PB
10	4	1	59S/PZ4

1/4" Standard Screwdriver Bits for TORX® Head Screws 25 mm



59S/T

Quantity	Bit Type	Quantity	Part Number
5	T3	1	59S/T3
3	T3	50	59S/T3-3P
3	T4	50	59S/T4-3P
5	T5	1	59S/T5
3	T5	50	59S/T5-3P
3	T6	50	59S/T6-3P
10	T7	1	59S/T7
3	T7	50	59S/T7-3P
10	T8	1	59S/T8
3	T8	50	59S/T8-3P
10	T9	1	59S/T9
3	T9	50	59S/T9-3P
10	T10	50	59S/T10-10P
3	T10	1	59S/T10-3P
30	T10	1	59S/T10-30P
10	T15	50	59S/T15-10P
3	T15	1	59S/T15-3P
30	T15	1	59S/T15-30P
10	T20	50	59S/T20-10P
3	T20	1	59S/T20-3P
30	T20	1	59S/T20-30P
10	T25	50	59S/T25-10P
3	T25	1	59S/T25-3P
30	T25	1	59S/T25-30P
10	T27	50	59S/T27-10P
3	T27	1	59S/T27-3P
10	T30	50	59S/T30-10P
3	T30	1	59S/T30-3P
30	T30	1	59S/T30-30P
10	T40	50	59S/T40-10P
3	T40	1	59S/T40-3P
30	T40	1	59S/T40-30P
5	T45	50	59S/T45-5P
3	T45	50	59S/T45-3P
5	T50	50	59S/T50-5P
3	T50	50	59S/T50-3P

1/4" Standard Screwdriver Conical Bits for Torx® Head Screws 25 mm



59S/TCS

Quantity	Bit Type	Quantity	Part Number
10	T10	20	59S/T10CS
10	T15	20	59S/T15CS
10	T20	20	59S/T20CS
10	T25	50	59S/T25CS-10P
10	T27	20	59S/T27CS
10	T30	20	59S/T30CS
10	T40	20	59S/T40CS

1/4" Standard Screwdriver Bits for TORX® Tamper-Resistant Screws 25 mm



59S/TR

Quantity	Bit Type	Quantity	Part Number
5	TR 7	1	59S/TR7
3	TR7	50	59S/TR7-3P
5	TR 8	1	59S/TR8
3	TR8	50	59S/TR8-3P
5	TR 9	1	59S/TR9
3	TR9	50	59S/TR9-3P
5	TR 10	50	59S/TR10-5P
3	TR 10	1	59S/TR10-3P
5	TR 15	1	59S/TR15
3	TR 15	1	59S/TR15-3P
5	TR 20	50	59S/TR20-5P
3	TR 20	1	59S/TR20-3P
5	TR 25	50	59S/TR25-5P
3	TR 25	1	59S/TR25-3P
5	TR 27	1	59S/TR27
3	TR 27	1	59S/TR27-3P
5	TR 30	50	59S/TR30-5P
3	TR 30	1	59S/TR30-3P
5	TR 40	1	59S/TR40
3	TR 40	1	59S/TR40-3P

1/4" Standard Screwdriver Bit for Hex Head Screws 25 mm



59S/H mm

Quantity	Bit Type	Quantity	Part Number
5	1.5	50	59S/H1.5-5P
3	1.5	50	59S/H1.5-3P
5	2	1	59S/H2
3	2	50	59S/H2-3P
5	2.5	50	59S/H2.5-5P
3	2.5	50	59S/H2.5-3P
5	3	50	59S/H3-5P
3	3	1	59S/H3-3P
5	4	50	59S/H4-5P
3	4	1	59S/H4-3P
500	4	500	59S/H4-1PB
5	5	50	59S/H5-5P
3	5	1	59S/H5-3P
5	6	50	59S/H6-5P
3	6	1	59S/H6-3P
5	8	50	59S/H8-5P
3	8	1	59S/H8-3P
5	10	50	59S/H10-5P
3	10	25	59S/H10-3P

1/4" Standard Screwdriver Bit for Hex Head Screws 25 mm



59S/H "

5	1/4 in	50	59S/H1/16-5P
3	1/16 in	50	59S/H1/16-3P
5	5/64 in	50	59S/H5/64-5P
3	5/64 in	50	59S/H5/64-3P
3	3/32 in	50	59S/H3/32-3P
5	3/32 in	50	59S/H3/32-5P
3	7/64 in	50	59S/H7/64-3P
5		50	59S/H7/64-5P
3	1/8 in	50	59S/H1/8-3P
5	1/8 in	50	59S/H1/8-5P
3	5/32 in	50	59S/H5/32-3P
5	5/32 in	50	59S/H5/32-5P
5	3/16 in	50	59S/H3/16-5P
3	7/32 in	50	59S/H7/32-3P
5	7/32 in	50	59S/H7/32-5P
3	1/4 in	50	59S/H1/4-3P
5	1/4 in	1	59S/H1/4
3	5/16 in	50	59S/H5/16-3P
3	3/8 in	25	59S/H3/8-3P
5	5/16 in	50	59S/H5/16-5P
5	3/8 in	1	59S/H3/8

1/4" Standard Screwdriver Bits for Robertson Head Screws 25 mm



59S/R

10	# 1	1	59S/R1
3	# 1	1	59S/R1-3P
3	# 2	1	59S/R2-3P
10	# 3	1	59S/R3
3	# 3	1	59S/R3-3P
10	# 4	1	59S/R4

1/4" Standard Screwdriver Bit for TORQ-SET Security Head Screws 25 mm



59S/TS

5	0	1	59S/TS-0
5	1	1	59S/TS-1
5	4	50	59S/TS-4-5P
5	5	50	59S/TS-5-5P
5	6	50	59S/TS-6-5P
5	8	50	59S/TS-8-5P
5	10	50	59S/TS-10-5P

1/4" Standard Screwdriver Bits for Tri-Wing Head Screws 25 mm - 5 Pcs/Plastic Box



59S/TW

5	TW 0	1	59S/TW0
5	TW 1	1	59S/TW1
5	TW 2	1	59S/TW2
5	TW 3	1	59S/TW3
5	TW 4	1	59S/TW4
5	TW 5	1	59S/TW5

1/4" Standard Screwdriver Bits for XZN Head Screws 25 mm



59S/M

10	M3	1	59S/M3
3	M3	50	59S/M3-3P
10	M4	1	59S/M4
3	M4	50	59S/M4-3P

10	M5	1	59S/M5
3	M5	50	59S/M5-3P
10	M6	1	59S/M6
3	M6	50	59S/M6-3P
10	M8	1	59S/M8
3	M8	50	59S/M8-3P

1/4" Standard Screwdriver Bits for Slotted Head Screws 50 mm



59S/50

5	3.5 mm	50	59S/50/0.6-3.5-5P
5	4.0 mm	50	59S/50/0.8-4.0-5P
5	5.5 mm	50	59S/50/0.8-5.5-5P
5	6.0 mm	50	59S/50/1.0-6.0-5P
5	6.5 mm	50	59S/50/1.2-6.5-5P
2	3.5 mm	50	59S/50/3.5-2P
2	4.0 mm	50	59S/50/4.0-2P
2	5.5 mm	50	59S/50/5.5-2P
2	6.0 mm	1	59S/50/6.0-2P
2	6.5 mm	50	59S/50/6.5-2P

1/4" Standard Screwdriver Bit for Phillips Head Screws 50 mm



59S/50PH

5	1	50	59S/50PH1-5P
2	1	1	59S/50PH1-2P
5	2	50	59S/50PH2-5P
2	2	1	59S/50PH2-2P
5	3	50	59S/50PH3-5P
2	3	1	59S/50PH3-2P



1/4" Standard Screwdriver Bit for Pozidriv Head Screws 50 mm



59S/50PZ

5	1	50	59S/50PZ1-5P
2	1	1	59S/50PZ1-2P
5	2	50	59S/50PZ2-5P
2	2	1	59S/50PZ2-2P
5	3	50	59S/50PZ3-5P
2	3	1	59S/50PZ3-2P

1/4" Standard Screwdriver Bit for TORX® Head Screws 50 mm



59S/50T

5	T 8	1	59S/50T8
2	T 8	50	59S/50T8-2P
2	T 10	1	59S/50T10-2P
5	T 10	50	59S/50T10-5P
5	T 15	50	59S/50T15-5P
2	T 15	1	59S/50T15-2P
5	T 20	50	59S/50T20-5P
2	T 20	1	59S/50T20-2P
5	T 25	50	59S/50T25-5P
2	T 25	1	59S/50T25-2P
5	T 27	1	59S/50T27
5	T 30	50	59S/50T30-5P
2	T 30	1	59S/50T30-2P
5	T 40	50	59S/50T40-5P
2	T 40	50	59S/50T40-2P

1/4" Standard Screwdriver Bit for Hex Head Screws 50 mm



59S/50H

5	2	1	59S/50H2
2	2	50	59S/50H2-2P
5	2.5	50	59S/50H2.5-5P
2	2.5	50	59S/50H2.5-2P
5	3	50	59S/50H3-5P
2	3	50	59S/50H3-2P
5	4	50	59S/50H4-5P
2	4	50	59S/50H4-2P
5	5	50	59S/50H5-5P
2	5	50	59S/50H5-2P
5	6	50	59S/50H6-5P
2	6	50	59S/50H6-2P
5	8	50	59S/50H8-5P
2	8	50	59S/50H8-2P

1/4" Standard Screwdriver Bits for Imperial Hex Head Screws 50 mm



59S/50H "

5	1/1 in	1	59S/50H1/16
5	5/64 in	1	59S/50H5/64
5	3/32 in	1	59S/50H3/32
5	7/64 in	1	59S/50H7/64
5	1/8 in	1	59S/50H1/8
5	5/32 in	1	59S/50H5/32
5	3/16 in	1	59S/50H3/16
5	7/32 in	1	59S/50H7/32
5	1/4 in	1	59S/50H1/4
5	5/16 in	1	59S/50H5/16
5	3/8 in	1	59S/50H3/8

1/4" Standard Screwdriver Bits for Robertson Head Screws 50 mm



59S/50R

5	#1	1	59S/50R1
2	#1	50	59S/50R1-2P
5	#2	1	59S/50R2
2	#2	50	59S/50R2-2P
5	#3	1	59S/50R3
2	#3	50	59S/50R3-2P

1/4" Standard Screwdriver Bit for Phillips Head Screws 70 mm



59S/70PH

5	1	25	59S/70PH1-5P
2	1	1	59S/70PH1-2P
5	2	25	59S/70PH2-5P
2	2	25	59S/70PH2-2P

1/4" Standard Screwdriver Bit for Pozidriv Head Screws 70 mm



59S/70PZ

5	1	25	59S/70PZ1-5P
2	1	1	59S/70PZ1-2P
5	2	25	59S/70PZ2-5P
2	2	1	59S/70PZ2-2P
5	3	1	59S/70PZ3
2	3	1	59S/70PZ3-2P

1/4" Standard Screwdriver Bits for TORX® Head Screws 70 mm



59S/70T

5	T10	25	59S/70T10-5P
2	T10	1	59S/70T10-2P
5	T15	25	59S/70T15-5P
2	T15	25	59S/70T15-2P
2	T20	25	59S/70T20-2P
5	T20	25	59S/70T20-5P
2	T25	25	59S/70T25-2P
5	T25	25	59S/70T25-5P
5	T27	1	59S/70T27
2	T27	1	59S/70T27-2P
2	T30	1	59S/70T30-2P
5	T30	25	59S/70T30-5P
5	T40	25	59S/70T40-5P
2	T40	1	59S/70T40-2P

1/4" Standard Screwdriver Bits for TORX® Tamper-Resistant Screws 70 mm



59S/70TR

5	TR15	1	59S/70TR15
2	TR15	1	59S/70TR15-2P
5	TR20	1	59S/70TR20
2	TR20	25	59S/70TR20-2P
5	TR25	1	59S/70TR25
2	TR25	25	59S/70TR25-2P
5	TR27	1	59S/70TR27
2	TR27	25	59S/70TR27-2P
5	TR30	1	59S/70TR30
2	TR30	25	59S/70TR30-2P
5	TR40	1	59S/70TR40
2	TR40	25	59S/70TR40-2P

1/4" Standard Screwdriver Bits for Hex with Ball Point Screws 89 mm



59S/H BALL

5	3	1	59S/H3BALL
2	3	1	59S/H3BALL-2P
2	4	1	59S/H4BALL-2P
5	5	1	59S/H5BALL
2	5	1	59S/H5BALL-2P
5	6	1	59S/H6BALL
2	6	1	59S/H6BALL-2P
5	8	1	59S/H8BALL
2	8	1	59S/H8BALL-2P
3	5,6,8	1	59S/HBALL-3P

1/4" Standard Screwdriver Bits for Phillips Head Screws 125 mm



59S/125PH

2	1	25	59S/125PH1-2P
2	2	25	59S/125PH2-2P
100	2	100	59S/125PH2-IP
2	3	25	59S/125PH3-2P
5	3	1	59S/125PH3

1/4" Standard Screwdriver Bits for Pozidriv Head Screws 125 mm



59S/125PZ

5	1	1	59S/125PZ1
2	1	25	59S/125PZ1-2P
5	2	1	59S/125PZ2
2	2	25	59S/125PZ2-2P
5	3	1	59S/125PZ3
2	3	25	59S/125PZ3-2P

1/4" Standard Screwdriver Bits for Plus-Minus/Phillips Head Screws 125 mm



59S/PH COMBI

2	5.0/PH1	1	59S/PH1COMBI-2P
2	6.0/PH2	40	59S/125PH2COMBI-2P
2	8.0/PH3	1	59S/PH3COMBI-2P

1/4" Standard Screwdriver Bits for TORX® Head Screws 150 mm



59S/150T

5	T15	1	59S/150T15
2	T15	1	59S/150T15-2P
2	T20	1	59S/150T20-2P
2	T25	1	59S/150T25-2P
2	T30	1	59S/150T30-2P

7/16" Screwdriver Bits for Hex Head Screws 35 mm



74S/H

5	4 mm	1	74S/H4
2	4 mm	25	74S/H4-2P
2	5 mm	25	74S/H5-2P
5	6 mm	1	74S/H6
2	6 mm	25	74S/H6-2P
5	7 mm	1	74S/H7
2	7 mm	25	74S/H7-2P
5	8 mm	1	74S/H8
2	8 mm	25	74S/H8-2P
5	10 mm	1	74S/H10
2	10 mm	25	74S/H10-2P
5	12 mm	1	74S/H12
2	12 mm	25	74S/H12-2P
5	14 mm	1	74S/H14
2	14 mm	1	74S/H14-2P
5	17 mm	1	74S/H17
2	17 mm	25	74S/H17-2P



5/32" Standard Screwdriver Bits for Phillips Head Screws 25 mm



45S/PH

5	1	1	45S/PH1
2	1	50	45S/PH1-2P
5	2	1	45S/PH2
2	2	50	45S/PH2-2P

5/32" Standard Screwdriver Bits for Hex Head Screws 25 mm



45S/H

5	1.5 mm	1	45S/H1.5
2	1.5 mm	50	45S/H1.5-2P
5	2 mm	1	45S/H2
2	2 mm	50	45S/H2-2P
5	2.5 mm	1	45S/H2.5
2	2.5 mm	50	45S/H2.5-2P
5	3 mm	1	45S/H3
2	3 mm	50	45S/H3-2P

1/4" Bit Set for Phillips/Pozidriv/TORX® Head Screws - 7 Pcs



59S/7-1

7	22 x 65 x 75 mm	1	59S/7-1*

59S/PH1, 59S/PH2		
59S/PZ1, 59S/PZ2		
59S/T15, 59S/T20		

1/4" Bit Set for Phillips/TORX® Head Screws - 7 Pcs



59S/7-2

7	22 x 65 x 75 mm	1	59S/7-2

59S/PH2		
59S/T15x 2, 59S/T20x 2, 59S/T25		

1/4" Bit Set for TORX® Tamper Resistant Screws - 7 Pcs



59S/7-3

7	22 x 65 x 75 mm	1	59S/7-3

59S/TR10, 59S/TR15, 59S/TR20, 59S/TR25, 59S/TR30, 59S/TR40		
--	--	--

1/4" Bit Set for TORX® Head Screws - 7 Pcs



59S/7-4

7	22 x 65 x 75 mm	1	59S/7-4

59S/T10, 59S/T15, 59S/T20, 59S/T25, 59S/T30, 59S/T40		
--	--	--

1/4" Bit Set for Phillips/Pozidriv/Torx® Head Screws in a Plastic Holder with Belt Clip - 10 pcs



59S/10BC

10	23 x 68 x 168 mm	1	59S/10BC

1/4" Conical Bit Set for Torx® Head Screws - 11 pcs



59S/TCS11-1

11	108 x 68 x 31 mm	10	59S/TCS11-1

59S/T10CS, 59S/T15CS, 59S/T20CSx 3, 59S/T25CSx 2, 59S/T30CSx 2, 59S/T40CS		
KM653-QR-1P		

1/4" Bit Set for Slotted/Phillips/Pozidriv/Hex Head Screws - 17 Pcs



59S/17-1

17	27 x 73 x 82 mm	1	59S/17-1

59S/0.5-3.0, 59S/0.6-4.5, 59S/0.8-5.5		
59S/PH1, 59S/PH2x 3		
59S/PH2Gx 2		
59S/PZ1, 59S/PZ2x 2		
59S/H3, 59S/H4, 59S/H5, 59S/H6		

1/4" Bit Set for TORX® Head Screws - 17 Pcs



59S/17-2

17	27 x 73 x 82 mm	1	59S/17-2

59S/T7, 59S/T8, 59S/T9, 59S/T10, 59S/T15x 2, 59S/T20x 3, 59S/T25x 3, 59S/T27, 59S/T30x 2, 59S/T40

1/4" Bit Set for Phillips/ Pozidriv/TORX®/ Hex Head Screws - 17 Pcs



59S/17-3

17	27 x 73 x 82 mm	1	59S/17-3*

59S/PH1, 59S/PH2x 2

59S/PZ1, 59S/PZ2, 59S/PZ3

59S/T10, 59S/T15, 59S/T20, 59S/T25, 59S/T27, 59S/T30, 59S/T40

59S/H3, 59S/H4, 59S/H5

1/4" bit set for Slotted/Phillips/Pozidriv/ TORX® Head Screw - 22 Pcs



59S/22-1

22	20 x 50 x 80 mm	12	59S/22-1

59S/0.5-3.0, 59S/0.6-4.5, 59S/0.8-5.5

59S/PH1, 59S/PH2, 59S/PH3

59S/PH2G

59S/PZ1, 59S/PZ2, 59S/PZ3

59S/T6, 59S/T8, 59S/T9, 59S/T10, 59S/T15, 59S/T20, 59S/T25, 59S/T27, 59S/T30, 59S/T40

K6650-1/4

1/4" bit set for Phillips/ Hex/ TORX® Head Screw - 22 Pcs



59S/22-2

22	20 x 50 x 80 mm	12	59S/22-2

59S/PH2x 3

59S/PH2Gx 3

59S/PZ2x 2

59S/T10, 59S/T15x 4, 59S/T20x 3, 59S/T25x 2

59S/H2.5, 59S/H3

K6650-1/4

1/4" Bit set for Slotted/ Phillips/ TORX®/ Hex/ TORQ-SET head screw - 28 Pcs



59S/28

28	30 x 58 x 110 mm	1	59S/28-4

59S/0.6-4.5, 59S/1.2-6.5, 59S/1.2-8.0

59S/PH1-10Px 2, 59S/PH2-10Px 2, 59S/PH3-10P

59S/T6-3P, 59S/T15-3P

59S/H5/64-5P, 59S/H3/32-5P, 59S/H7/64-5P, 59S/H1/8-5P, 59S/H9/64, 59S/H5/32-5P, 59S/H3/16-5P, 59S/H7/32-5P

59S/TS-4-5Px 2, 59S/TS-6-5Px 2, 59S/TS-8-5Px 2, 59S/TS-10-5Px 2

K6625-1/4B-5P

KM653-5P

1/4" Bit Set for Slotted/Phillips/Pozidriv/ TORX®/Hex Head Screw - 31 Pcs



59S/31B

31	40.25 x 104.90 x 65.35 mm	6	59S/31B

59S/0.6-4.5, 59S/1.0-5.5

59S/PH1, 59S/PH2x 3, 59S/PH3

59S/PH2Gx 2

59S/PZ1, 59S/PZ2x 3, 59S/PZ3

59S/T10, 59S/T15x 3, 59S/T20x 3, 59S/T25x 2, 59S/T27, 59S/T30

59S/H3, 59S/H4, 59S/H5, 59S/H6

K6625-1/4-1P

KM653-QR-1P

1/4" Bit Set for Slotted/Phillips/Pozidriv/ TORX®/Hex Head Screw - 31 Pcs/12 Pcs Carton Display



59S/31B-IP

12	105 x 375 x 205 mm	12	59S/31B-IP

Order 12 pieces of the ref. 59S/31B-IP to receive 1 display

* Until stocks last



1/4" bit set for Slotted/ Phillips/ Pozidriv/ Hex/ TORX® screw - 31 Pcs



59S/31-1

31	42 x 65 x 110 mm	12 59S/31-1

59S/0.5-3.0, 59S/0.6-4.5, 59S/0.8-5.5		
59S/PH1, 59S/PH2x 3, 59S/PH3		
59S/PH2Gx 2		
59S/PZ1, 59S/PZ2x 3, 59S/PZ3		
59S/T10, 59S/T15x 3, 59S/T20x 3, 59S/T25x 2, 59S/T27, 59S/T30		
59S/H3, 59S/H4, 59S/H5, 59S/H6		
KM653-QR		

1/4" Bit Set for Phillips/Pozidriv/TORX® Screws - 31 Pcs



59S/31-2

31	42 x 65 x 110 mm	1 59S/31-2

59S/PH2x 4		
59S/PH2Gx 4		
59S/PZ2x 4		
59S/T10x 2, 59S/T15x 4, 59S/T20x 5, 59S/T25x 5, 59S/T30x 2		
KM653-QR		

1/4" bit set for Phillips/ Pozidriv/ Hex/ TORX® head screw - 35 Pcs



59/S35BC

35	50 x 110 x 180 mm	1 59/S35BC

1/4" Bit Set for Slotted/Phillips/Pozidriv/ Hex/TORX®/TORX® Tamper/Robertson Screw - 54 Pcs



59/S54BC

54	50 x 110 x 184 mm	20 59/S54BC

TORX bits are colored to easy identify the size of the tip

1/4" Bit Set for Slotted/Phillips/Pozidriv/ Hex/TORX®/TORX® Tamper/Robertson Screw - 54 Pcs/8 Pcs Carton Display



59/S54BC-IP

54	300 x 190 x 280 mm	8 59/S54BC-IP

Order 8 pieces of the re. 59/S54BC-IP to receive 1 display TORX bits are colored to easy identify the size of the tip

1/4" Bit Set for Slotted/Phillips/Pozidriv/ Hex/ TORX®/TORX® Tamper/Robertson Screw - 100 Pcs



59/S100BC

100	50 x 110 x 184 mm	1 59/S100BC

TORX bits are colored

1/4" Bit Set for Slotted/Phillips/Pozidriv/ Hex/ TORX®/TORX® Tamper/Robertson Screw - 100 Pcs/8 Pcs Carton Display



59/S100BC-IP

100	300 x 190 x 280 mm	8 59/S100BC-IP

Order 8 pieces of the re. 59/S100BC-IP to receive 1 display TORX bits are colored to easy identify the size of the tip

1/4" Standard Bit and Socket Set for Slotted/Phillips/Pozidriv/TORX®/Hex Head Screw - 26 Pcs



2058/S26

26	80 x 100 x 35 mm	30 2058/S26

SB: Retail pack on a plastic info card

6950CBR	
K6625-1/4-1P	
59S/H6, 59S/H5, 59S/H4, 59S/H3	
59S/T15, 59S/T10, 59S/T30, 59S/T25, 59S/T20	
59S/PZ3, 59S/PZ1, 59S/PZ2	
59S/PH1, 59S/PH2, 59S/PH3	
59S/0.8-5.5, 59S/0.5-4.0	
6700SM-8, 6700SM-7, 6700SM-6, 6700SM-13, 6700SM-10	
59S/1.0-6.0-IP	

1/4" Small Bit and Socket Set for Slotted/Phillips/Pozidriv/TORX®/Hex Head Screw Retail Pack - 26 Pcs



SB2058/S26

26	35 x 85 x 105 mm	12	SB2058/S26

18 bits + 5 sockets + 1 bit ratchet 6950CBR + 1 adaptor + 1 bit holder

1/4" Standard Bit and Socket Set for Slotted/Phillips/Pozidriv/TORX®/Hex Head Screw - 26 Pcs



2058/S26AF

26	80 x 100 x 35 mm	1	2058/S26AF

1/4" Small Bit and Socket Set for Slotted/Phillips/Pozidriv/TORX®/Hex Head Screw - 26 Pcs



2058/S26-2

26	80 x 100 x 35 mm	1	2058/S26-2

2058-BR, K6625-1/4, KM653-QR		
6700SM-8, 6700SM-7, 6700SM-6, 6700SM-5, 6700SM-4		
59S/0.5-3.0, 59S/0.8-5.5, 59S/0.5-4.0		
59S/T8, 59S/T7, 59S/T6, 59S/T5, 59S/T4		
59S/PZ1, 59S/PZ0, 59S/PZ2		
59S/H2, 59S/H2.5, 59S/H1.5, 59S/H3		
59S/PH1, 59S/PH0, 59S/PH2		

1/4" Standard Screwdriver Bit Set for PH2 Head Screws 25 mm - 5 Pcs



59S/PH2PEN

5	13 x 17 x 132 mm	10	59S/PH2PEN*

1/4" Standard Screwdriver Bit Set for PZ2 Head Screws 25 mm - 5 Pcs



59S/PZ2PEN

5	13 x 17 x 132 mm	10	59S/PZ2PEN*

1/4" Standard Screwdriver Bit Set for Torx® Screws 25 mm - 5 Pcs



59S/TORXPEN

5	13 x 17 x 132 mm	10	59S/T15PEN*
5	13 x 17 x 132 mm	10	59S/T20PEN*
5	13 x 17 x 132 mm	10	59S/T25PEN*

1/4" Bit Pocket Set for Phillips/Pozidriv/Torx® Head Screws - 60 Pcs/Counter Display



59S/60PEN/DISP

60	140 x 125 x 215 mm	1	59S/60PEN/DISP*

59S/T15PENx 5, 59S/T20PENx 30, 59S/T25PENx 5		
59S/PH2PENx 10		
59S/PZ2PENx 10		

5/16" Impact Screwdriver Bit for Slotted Head Screws



70S/

2	8.0 mm	25	70S/1.2-8.0-2P
5	9.0 mm	1	70S/1.6-9.0
2	9.0 mm	25	70S/1.6-9.0-2P
2	10.0 mm	25	70S/1.6-10.0-2P
5	12.0 mm	1	70S/2.0-12.0
2	12.0 mm	25	70S/2.0-12.0-2P
5	14.0 mm	1	70S/2.5-14.0
2	14.0 mm	25	70S/2.5-14.0-2P

* Until stocks last



5/16" Screwdriver Bits for Phillips Head Screws 32 mm-38 mm



70S/PH

5	1	1	70S/PH1
2	1	25	70S/PH1-2P
5	2	1	70S/PH2
2	2	25	70S/PH2-2P
5	3	1	70S/PH3
2	3	25	70S/PH3-2P
5	4	1	70S/PH4
2	4	25	70S/PH4-2P

5/16" Screwdriver Bits for Pozidriv Head Screws 32 mm-38 mm



70S/PZ

5	1	1	70S/PZ1
2	1	25	70S/PZ1-2P
5	2	1	70S/PZ2
2	2	25	70S/PZ2-2P
5	3	1	70S/PZ3
2	3	25	70S/PZ3-2P
5	4	1	70S/PZ4
2	4	25	70S/PZ4-2P

5/16" Screwdriver Bits for TORX® Head Screws 35 mm



70S/T

5	T25	50	70S/T25-5P
5	T40	50	70S/T40-5P
5	T20	1	70S/T20

2	T20	25	70S/T20-2P
2	T25	25	70S/T25-2P
2	T27	1	70S/T27-2P
2	T30	25	70S/T30-2P
5	T45	1	70S/T45
2	T45	25	70S/T45-2P
5	T50	1	70S/T50
2	T50	25	70S/T50-2P*
5	T55	1	70S/T55
2	T55	25	70S/T55-2P

5/16" Screwdriver Bits for TORQ-SET® Head Screws 32 mm



70S/TS

5	8 mm	1	70S/TS8
2	8 mm	25	70S/TS8-2P
5	10 mm	1	70S/TS10
2	10 mm	25	70S/TS10-2P

5/16" Imperial Screwdriver Bits for TORQ-SET® Head Screws 32 mm



70S/TS''

5	1/4"	1	70S/TS1/4
2	1/4"	25	70S/TS1/4-2P
5	5/16"	1	70S/TS5/16
2	5/16"	25	70S/TS5/16-2P

5/16" Screwdriver Bits for Hex Socket Head Screws



70S/H

5	4 mm	1	70S/H4
2	4 mm	25	70S/H4-2P
2	5 mm	25	70S/H5-2P
2	6 mm	25	70S/H6-2P
5	7 mm	1	70S/H7
2	7 mm	25	70S/H7-2P
2	8 mm	25	70S/H8-2P
5	10 mm	1	70S/H10*
2	10 mm	25	70S/H10-2P
5	12 mm	1	70S/H12
2	12 mm	25	70S/H12-2P
5	14 mm	1	70S/H14
2	14 mm	25	70S/H14-2P

5/16" Hand Operated Impact Driver with 1/2" Square Drive 125 mm



5521

125 mm		1	5521

1/2" Square screwdriver adaptor for bits 5/16"



54640

40 mm		1	54640

5/16" Bit Set for Slotted/ Phillips/Hex/ TORX® Head Screws - 23 Pcs



7823



23 45 x 70 x 197 mm 16 7823

5521	
54640	
70S/1.2-8.0, 70S/1.6-10.0, 70S/2.0-12.0	
70S/PH2, 70S/PH3, 70S/PH4	
70S/T20, 70S/T25, 70S/T27, 70S/T30, 70S/T40, 70S/T45, 70S/T50, 70S/T55	
70S/H4, 70S/H5, 70S/H6, 70S/H7, 70S/H8, 70S/H10, 70S/H12, 70S/H14	

5/16" Bit Set for Slotted/Phillips/Hex Head Screws - 14 Pcs



7865



15 55 x 90 x 220 mm 1 7865

Including 1 adapter, hexagon 5/16" to 3/8" square drive

5521	
54640	
70S/1.2-8.0, 70S/1.6-10.0	
70S/PH1, 70S/PH2, 70S/PH3, 70S/PH4	
70S/H4, 70S/H5, 70S/H6, 70S/H8	

Threaded Screwdriver Bits for Phillips Head Screws



K18

1	2	5	K18NF-2
1	2	5	K18PH-2M5
1	2	5	K18PH-2M6

Threaded Screwdriver Bits for Pozidriv Head Screws



K19PZD-2NF

1	2	1	K19PZD-2NF
1	2	1	K19PZD-2M5

Threaded Screwdriver Bits for TORX® Head Screws 44.5 mm



K20TORX

1	T25	10	K20TORX-T25

1/4" Hex Head Non-Magnetic Power Nut Driver Socket



K6750

1	1/4 in	1	K6750-6
1	1/4 in	1	K6750-7*
1	1/4 in	20	K6750-8-1P
1	1/4 in	20	K6750-10-1P
1	1/4 in	1	K6750-13
1	1/4 in	1	K6750-1/4
1	1/4 in	1	K6750-3/8

1/4" Hex Head Magnetic Power Nut Driver Socket



KM6750

1		1	KM6750-6
1		1	KM6750-7-1P
1		1	KM6750-8-1P
1		1	KM6750-10-1P
1		1	KM6750-11-1P
1		1	KM6750-13-1P
1		1	KM6750-1/4
1		1	KM6750-3/8

1/4" Hex Universal Magnetic Bit Holders with Quick Release 60 mm



KM653-QR

1	1/4"	50	KM653-QR-1P
5	1/4"	25	KM653-QR-5P

* Until stocks last



1/4" Hex Universal Magnetic Bit Holders with Quick Release 75 mm



KM753-QR

1	1/4 in	1	KM753-QR-1P*

1/4" Heavy-Duty Torsion Screwdriver Bit Holders



KMT753-QR-1P

1/4 in	1/4 in	50	KMT753-QR-1P

1/4" Hex Universal Magnetic Bit Holders with Retaining Ring 75 mm



KMR753

1	1/4 in	1	KMR753-1P
5	1/4 in	1	KMR753

1/4" Hex Universal Bit Holders with Retaining Ring 60 mm



KR653

1	1/4 in	25	KR653-1P
5	1/4 in	1	KR653

1/4" Hex Universal magnetic bit holder with Swivel Function 65 mm



KM653-SF

1	1/4" in	1	KM653-SF

1/4" Hex Copper-Beryllium Universal bit holder with Retaining Ring 75 mm



KCB753

1	1/4 in	1	KCB753

1/4" Hex Universal Magnetic Bit Holders 60 mm



KM653

1	1/4"	25	KM653-1P
5	1/4"	25	KM653-5P

1/4" Hex Universal Magnetic Bit Holder with Retaining Ring 60 mm



KMR653

1	1/4 in	1	KMR653-1P
5	1/4 in	50	KMR653-5P

1/4" Hex Universal Magnetic Bit Holders with Retaining Ring 150 mm



KMR150

1	1/4 in	1	KMR150-1P

1/4" Hex drive Universal Magnetic Bit Holder for 5/16" bits 70 mm



KM1/4-5/16-1P

1	1/4 in	50	KM1/4-5/16-1P

1/4" Hex Drive to 1/4" Socket adaptors 25 mm



K6625

1	1/4 in	80	K6625-1/4B-1P
5	1/4 in	50	K6625-1/4B-5P

1/4" Hex Drive to 3/8" Socket Adaptors 38 mm



K6638

1	1/4 in	25	K6638-3/8-1P
5	1/4 in	1	K6638-3/8

1/4" Hex to 1/2" Square Drive Adaptor 50 mm



K6650

1	1/4 in	20	K6650-1/4B-1P
5	1/4 in	50	K6650-1/4P-5P
5	1/4 in	25	K6650-3/8P-5P
5	1/4 in	25	K6650-1/2P-5P
1	1/4 in	20	K6650-3/8P-1P
1	1/4 in	20	K6650-1/2P-1P

1/4" Hex Drive to 1/4", 3/8" Socket Adaptors 100 mm



K66100

1	1/4 in	20	K66100-1/4P-1P
5	1/4 in	1	K66100-1/4
1	1/4 in	25	K66100-3/8-1P
5	1/4 in	1	K66100-3/8

1/4" Hex Drive to 1/4" Socket Adaptor with Quick Release 60 mm



K6660-QR

1	1/4 in	1	K6660-QR-1P

IMPACT SOCKETS

1/4" Square Drive Impact Sockets with Metric Hex Profile and Phosphate Finish



K6701M

6 mm	1	K6701M-6
7 mm	1	K6701M-7
8 mm	1	K6701M-8
9 mm	1	K6701M-9
10 mm	1	K6701M-10
11 mm	1	K6701M-11
12 mm	1	K6701M-12
13 mm	1	K6701M-13
14 mm	1	K6701M-14

1/4" Square Drive Impact Sockets with Metric Hex Profile and Phosphate Finish - Retail Pack



SBK6701M

6 mm	1	SBK6701M-6
7 mm	1	SBK6701M-7
8 mm	1	SBK6701M-8
9 mm	1	SBK6701M-9
10 mm	1	SBK6701M-10
11 mm	1	SBK6701M-11
12 mm	1	SBK6701M-12
13 mm	1	SBK6701M-13
14 mm	1	SBK6701M-14

* Until stocks last



1/4" Square Drive Magnetic Impact Sockets with Metric Hex Profile and Phosphate Finish



KM6701M

Hex Size	Quantity	Part Number
7 mm	1	KM6701M-7
8 mm	1	KM6701M-8
10 mm	1	KM6701M-10

Safety Clamping Springs for 1/4" Impact Socket



K560F-1

Hex Size	Quantity	Part Number
1/4 in	5	K560F-1

3/8" Square Drive Impact Sockets with Metric Hex Profile and Phosphate Finish



K7401M

Hex Size	Quantity	Part Number
7 mm	1	K7401M-7
8 mm	1	K7401M-8
9 mm	1	K7401M-9
10 mm	1	K7401M-10
11 mm	1	K7401M-11
12 mm	1	K7401M-12
13 mm	1	K7401M-13
14 mm	1	K7401M-14
15 mm	1	K7401M-15
16 mm	1	K7401M-16
17 mm	1	K7401M-17
18 mm	1	K7401M-18
19 mm	1	K7401M-19

Hex Size	Quantity	Part Number
20 mm	1	K7401M-20
21 mm	1	K7401M-21
22 mm	1	K7401M-22
24 mm	1	K7401M-24

3/8" Square Drive Impact Sockets with Metric Hex Profile and Phosphate Finish - Retail Pack



SBK7401M

Hex Size	Quantity	Part Number
7 mm	1	SBK7401M-7
8 mm	1	SBK7401M-8
9 mm	1	SBK7401M-9
10 mm	1	SBK7401M-10
11 mm	1	SBK7401M-11
12 mm	1	SBK7401M-12
13 mm	1	SBK7401M-13
14 mm	1	SBK7401M-14
15 mm	1	SBK7401M-15
16 mm	1	SBK7401M-16
17 mm	1	SBK7401M-17
18 mm	1	SBK7401M-18
19 mm	1	SBK7401M-19
20 mm	1	SBK7401M-20
21 mm	1	SBK7401M-21
22 mm	1	SBK7401M-22
24 mm	1	SBK7401M-24

3/8" Square Drive Deep Impact Sockets with Metric Hex Profile and Phosphate Finish



K7406M

Hex Size	Quantity	Part Number
10 mm	1	K7406M-10
13 mm	1	K7406M-13
17 mm	1	K7406M-17

3/8" Square Drive Impact Sockets with Imperial Hex Profile



K7401Z

Hex Size	Quantity	Part Number
3/8 in	1	K7401Z-3/8"
7/16 in	1	K7401Z-7/16"
1/2 in	1	K7401Z-1/2"
9/16 in	1	K7401Z-9/16"
5/8 in	1	K7401Z-5/8"
11/16 in	1	K7401Z-11/16"
3/4 in	1	K7401Z-3/4"
13/16 in	1	K7401Z-13/16"
7/8 in	1	K7401Z-7/8"

3/8" Square Drive to 1/4" Bit Holder Power Adaptors



K172

Hex Size	Quantity	Part Number
1/4"	1	K172

3/8" Square Drive Bit Holder Adaptors with Phosphate Finish



7407H-7409H

Hex Size	Quantity	Part Number
1/4"	1	7407H
5/16"	1	7408H
11	1	7409H

3/8" Square Drive Impact Sockets with TORX® Head Profile and Phosphate Finish



K7401TORX-E

Head Profile	Thread	Quantity	Part Number
E5	M4	1	K7401TORX-E5*
E6	M5	1	K7401TORX-E6*
E7	M6	1	K7401TORX-E7*
E8	M6, M7	1	K7401TORX-E8*
E10	M6, M8	1	K7401TORX-E10*
E12	M8, M10	1	K7401TORX-E12*
E14	M10, M12	1	K7401TORX-E14*

3/8" Square Drive Impact Power Swivel Sockets with Metric Hex Profile



KS7401M

Hex Profile	Quantity	Part Number
3/8 in	1	KS7401M-9*
3/8 in	1	KS7401M-10*
3/8 in	1	KS7401M-11*
3/8 in	1	KS7401M-12*
3/8 in	1	KS7401M-13*
3/8 in	1	KS7401M-14*
3/8 in	1	KS7401M-15*
3/8 in	1	KS7401M-16*
3/8 in	1	KS7401M-17*
3/8 in	1	KS7401M-18*
3/8 in	1	KS7401M-19*
3/8 in	1	KS7401M-22*

3/8" Square Drive Ball Joint Sockets with Phosphate Finish



K7767S

Hex Profile	Quantity	Part Number
3/8"	1	K7767S

3/8" Square Drive Adaptors with Phosphate Finish



K6964C

Hex Profile	Quantity	Part Number
1/4"	1	K6964C

3/8" Square Drive Adaptors with Phosphate Finish



K8164C

Hex Profile	Quantity	Part Number
1/2"	1	K8164C

3/8" Square Drive Extensions with Phosphate Finish



K7760C

Length	Quantity	Part Number
75 mm	1	K7760C-1
150 mm	1	K7760C-2

Safety Clamping Springs for 3/8" Impact Socket



K560F-2/3

Hex Profile	Hex Size	Quantity	Part Number
3/8"	7-12	5	K560F-2
3/8"	13-24	5	K560F-3

Impact Hexagon Sockets Set with Metric Hex Profile -10 Pcs



K7401M/10

Quantity	Weight	Quantity	Part Number
10	700 g	1	K7401M/10

K7401M-10, K7401M-11, K7401M-12, K7401M-13, K7401M-14, K7401M-15, K7401M-16, K7401M-17, K7401M-18, K7401M-19

* Until stocks last



3/8" Square Drive Impact Socket Set with TORX® Head Profile and Phosphate Finish - 7 Pcs



K7401TORX-E-S7



7 340 g 1 K7401TORX-E-S7*

K7401TORX-E5, K7401TORX-E6, K7401TORX-E7, K7401TORX-E8, K7401TORX-E10, K7401TORX-E12, K7401TORX-E14

1/2" Square Drive Ultrashort Impact Sockets with Metric Hex Profile and Phosphate Finish



K7800M



10 mm	1	K7800M-10
11 mm	1	K7800M-11
12 mm	1	K7800M-12
13 mm	1	K7800M-13
14 mm	1	K7800M-14
15 mm	1	K7800M-15
16 mm	1	K7800M-16
17 mm	1	K7800M-17
18 mm	1	K7800M-18
19 mm	1	K7800M-19
21 mm	1	K7800M-21
22 mm	1	K7800M-22
24 mm	1	K7800M-24

1/2" Square Drive Impact Sockets with Metric Hex Profile and Phosphate Finish



K7801M



8 mm	1	K7801M-8
9 mm	1	K7801M-9
10 mm	1	K7801M-10



11 mm	1	K7801M-11
12 mm	1	K7801M-12
13 mm	1	K7801M-13
14 mm	1	K7801M-14
15 mm	1	K7801M-15
16 mm	1	K7801M-16
17 mm	1	K7801M-17
18 mm	1	K7801M-18
19 mm	1	K7801M-19
20 mm	1	K7801M-20
21 mm	1	K7801M-21
22 mm	1	K7801M-22
23 mm	1	K7801M-23
24 mm	1	K7801M-24
25 mm	1	K7801M-25
26 mm	1	K7801M-26
27 mm	1	K7801M-27
28 mm	1	K7801M-28
29 mm	1	K7801M-29
30 mm	1	K7801M-30
32 mm	15	K7801M-32
34 mm	1	K7801M-34
36 mm	1	K7801M-36

1/2" Square Drive Impact Sockets with Metric Hex Profile and Phosphate Finish - Retail Pack



SBK7801M



8 mm	1	SBK7801M-8
9 mm	1	SBK7801M-9
10 mm	1	SBK7801M-10
11 mm	1	SBK7801M-11
12 mm	1	SBK7801M-12
13 mm	1	SBK7801M-13
14 mm	1	SBK7801M-14
15 mm	1	SBK7801M-15
16 mm	1	SBK7801M-16
17 mm	1	SBK7801M-17
18 mm	1	SBK7801M-18
19 mm	1	SBK7801M-19
20 mm	1	SBK7801M-20
21 mm	1	SBK7801M-21
22 mm	1	SBK7801M-22
23 mm	1	SBK7801M-23
24 mm	1	SBK7801M-24
25 mm	1	SBK7801M-25
26 mm	1	SBK7801M-26
27 mm	1	SBK7801M-27
28 mm	1	SBK7801M-28
29 mm	1	SBK7801M-29
30 mm	1	SBK7801M-30
32 mm	1	SBK7801M-32
34 mm	1	SBK7801M-34
36 mm	1	SBK7801M-36

1/2" Square Drive Deep Impact Sockets with Metric Hex Profile and Phosphate Finish



K7806M



10 mm	1	K7806M-10
11 mm	1	K7806M-11
12 mm	1	K7806M-12
13 mm	1	K7806M-13
14 mm	1	K7806M-14
15 mm	1	K7806M-15
16 mm	1	K7806M-16
17 mm	1	K7806M-17
18 mm	1	K7806M-18
19 mm	1	K7806M-19
21 mm	1	K7806M-21
22 mm	1	K7806M-22
23 mm	1	K7806M-23
24 mm	1	K7806M-24
27 mm	1	K7806M-27
30 mm	1	K7806M-30
32 mm	1	K7806M-32
33 mm	1	K7806M-33
34 mm	1	K7806M-34
36 mm	1	K7806M-36

SB: Retail pack on a plastic info card

1/2" Square Drive Deep Impact Sockets with Metric Hex Profile and Phosphate Finish - Retail Pack



SBK7806M



10 mm	1	SBK7806M-10
11 mm	1	SBK7806M-11
12 mm	1	SBK7806M-12
13 mm	1	SBK7806M-13
14 mm	1	SBK7806M-14
15 mm	1	SBK7806M-15
16 mm	1	SBK7806M-16
17 mm	1	SBK7806M-17
18 mm	1	SBK7806M-18
19 mm	1	SBK7806M-19
21 mm	1	SBK7806M-21
22 mm	1	SBK7806M-22
23 mm	1	SBK7806M-23
24 mm	1	SBK7806M-24
27 mm	1	SBK7806M-27
30 mm	1	SBK7806M-30
32 mm	1	SBK7806M-32
36 mm	1	SBK7806M-36

SB: Retail pack on a plastic info card

1/2" Square Drive Impact Sockets with Imperial Hex Profile and Phosphate Finish



K7801Z



Size	Quantity	Part Number
3/8 in	1	K7801Z-3/8
7/16 in	1	K7801Z-7/16
1/2 in	1	K7801Z-1/2
9/16 in	1	K7801Z-9/16
5/8 in	1	K7801Z-5/8
11/16 in	1	K7801Z-11/16
3/4 in	1	K7801Z-3/4
13/16 in	1	K7801Z-13/16
7/8 in	1	K7801Z-7/8
15/16 in	1	K7801Z-15/16
1 in	1	K7801Z-1
1 1/16 in	1	K7801Z-1.1/16
1 1/8 in	1	K7801Z-1.1/8
1 1/4 in	1	K7801Z-1.1/4
1 5/16 in	5	K7801Z-1.5/16
1 3/8 in	5	K7801Z-1.3/8
1 7/16 in	5	K7801Z-1.7/16
1 1/2 in	5	K7801Z-1.1/2

1/2" Square Drive Deep Impact Sockets with Imperial Hex Profile and Phosphate Finish



K7806Z



Size	Quantity	Part Number
3/8 in	10	K7806Z-3/8
7/16 in	5	K7806Z-7/16
1/2 in	10	K7806Z-1/2
9/16 in	10	K7806Z-9/16
5/8 in	5	K7806Z-5/8
11/16 in	5	K7806Z-11/16
3/4 in	5	K7806Z-3/4
13/16 in	5	K7806Z-13/16
7/8 in	5	K7806Z-7/8
15/16 in	5	K7806Z-15/16
1 in	5	K7806Z-1
1 1/16 in	5	K7806Z-1.1/16
1 1/8 in	5	K7806Z-1.1/8
1 1/4 in	5	K7806Z-1.1/4
1 5/16 in	5	K7806Z-1.5/16
1 3/8 in	5	K7806Z-1.3/8
1 7/16 in	5	K7806Z-1.7/16
1 1/2 in	5	K7806Z-1.1/2

SB: Retail pack on a plastic info card

1/2" Square Drive Impact Socket Drivers for Hex Head Screws Phosphate Finish



7993S



Size	Quantity	Part Number
5 mm	1	7993S0050
6 mm	1	7993S0060
8 mm	1	7993S0080
10 mm	1	7993S0100
12 mm	1	7993S0120
14 mm	1	7993S0140
17 mm	1	7993S0170
18 mm	1	7993S0180
19 mm	1	7993S0190

1/2" Square Drive Impact Sockets with Imperial Hex Profile and Phosphate Finish - Retail Pack



SBK7801Z



Size	Quantity	Part Number
3/8 in	1	SBK7801Z-3/8
7/16 in	1	SBK7801Z-7/16
1/2 in	1	SBK7801Z-1/2
9/16 in	1	SBK7801Z-9/16
5/8 in	1	SBK7801Z-5/8
11/16 in	1	SBK7801Z-11/16
3/4 in	1	SBK7801Z-3/4
13/16 in	1	SBK7801Z-13/16
7/8 in	1	SBK7801Z-7/8
15/16 in	1	SBK7801Z-15/16
1 in	1	SBK7801Z-1
1 1/16 in	1	SBK7801Z-1.1/16
1 1/8 in	1	SBK7801Z-1.1/8
1 1/4 in	1	SBK7801Z-1.1/4
1 5/16 in	1	SBK7801Z-1.5/16
1 3/8 in	1	SBK7801Z-1.3/8
1 7/16 in	1	SBK7801Z-1.7/16
1 1/2 in	1	SBK7801Z-1.1/2

SB: Retail pack on a plastic info card

1/2" Square Drive Deep Impact Sockets with Imperial Hex Profile and Phosphate Finish - Retail pack



SBK7806Z



Size	Quantity	Part Number
3/8 in	10	SBK7806Z-3/8
7/16 in	10	SBK7806Z-7/16
1/2 in	10	SBK7806Z-1/2
9/16 in	10	SBK7806Z-9/16
5/8 in	5	SBK7806Z-5/8
11/16 in	1	SBK7806Z-11/16
3/4 in	1	SBK7806Z-3/4
13/16 in	1	SBK7806Z-13/16
7/8 in	1	SBK7806Z-7/8
15/16 in	1	SBK7806Z-15/16
1 in	1	SBK7806Z-1
1 1/16 in	1	SBK7806Z-1.1/16
1 1/8 in	5	SBK7806Z-1.1/8
1 1/4 in	1	SBK7806Z-1.1/4
1 5/16 in	1	SBK7806Z-1.5/16
1 3/8 in	5	SBK7806Z-1.3/8
1 7/16 in	5	SBK7806Z-1.7/16
1 1/2 in	1	SBK7806Z-1.1/2

SB: Retail pack on a plastic info card

1/2" Square Drive Impact Socket Drivers for TORX® Head Screws Phosphate Finish



7994S



Size	Quantity	Part Number
T20	1	7994S0200
T25	1	7994S0250
T27	1	7994S0270
T-30	1	7994S0300
T-40	1	7994S0400
T-45	1	7994S0450
T-50	1	7994S0500
T-55	1	7994S0550
T-60	1	7994S0600
T-70	1	7994S0700



1/2" Square Drive Impact Sockets with TORX® Head Profile and Phosphate Finish



K7801TORX-E



E10	1	K7801TORX-E10
E12	1	K7801TORX-E12
E14	1	K7801TORX-E14
E16	1	K7801TORX-E16
E18	1	K7801TORX-E18
E20	1	K7801TORX-E20
E24	1	K7801TORX-E24

1/2" Square Drive Ball Joint Sockets with Phosphate Finish



K8167S



1/2"	1/2"	1	K8167S
------	------	---	--------

Safety Clamping Springs for 1/2" Impact Socket



K560F-4/5



1/2"	10-14 mm	5	K560F-4
1/2"	15-32 mm	5	K560F-5

1/2" Square Drive Bit Holders with Phosphate Finish



7807H-7809H



1/2"	1/4 in	1	7807H
1/2"	5/16 in	1	7808H
1/2"	11.2 mm	1	7809H
1/2"	1/4 in	1	SB7807H
1/2"	5/16 in	1	SB7808H
1/2"	7/16 in	1	SB7809H

1/2" Square Drive Adaptors with Phosphate Finish



K7764D/SBK7764D



M 3/8"	F 1/2"	1	K7764D
M 3/8"	F 1/2"	1	SBK7764D

SB: Retail pack

1/2" Square Drive Ultrashort impact socket set, 1/2" - 13 Pcs



K7800M/13



13	43 x 128 x 195 mm	1	K7800M/13
----	-------------------	---	-----------

K7800M-10, K7800M-11, K7800M-12, K7800M-13, K7800M-14, K7800M-15, K7800M-16, K7800M-17, K7800M-18, K7800M-19, K7800M-21, K7800M-22, K7800M-24

4750IB-A5

1/2" Square Drive Extensions with Phosphate Finish



K8160D



75 mm	1	K8160D-1
125 mm	1	K8160D-2
250 mm	1	K8160D-3
75 mm	1	SBK8160D-1
125 mm	1	SBK8160D-2
250 mm	1	SBK8160D-3

1/2" Square Drive to 3/4" Increasing Adaptor with Phosphate Finish



K8964D/SBK8964D



3/4"	1/2"	1	K8964D
M 3/4"	F 1/2"	1	SBK8964D

SB: Retail pack on a plastic info card

1/2" Square Drive Deep Impact Socket Set in Case with Metric Hex Profile and Phosphate Finish - 4 Pcs



K7806M/S4



4	1140 g	1	K7806M/S4
---	--------	---	-----------

K7806M-19, K7806M-22, K7806M-17, K7806M-24

4750IB-A5

1/2" Square Drive Impact Socket Set with Imperial Hex Profile and Phosphate Finish - 10 Pcs



K7801Z/10

10	60 x 220 x 280 mm	1	K7801Z/10

K7801Z-7/16, K7801Z-1/2, K7801Z-11/16, K7801Z-5/8, K7801Z-13/16, K7801Z-3/4, K7801Z-15/16, K7801Z-7/8, K7801Z-1, K7801Z-9/16

1/2" Square Drive Deep Impact Socket Set with Imperial Hex Profile and Phosphate Finish - 10 Pcs



K7806Z/10

10	60 x 220 x 280 mm	1	K7806Z/10

K7806Z-7/16, K7806Z-1/2, K7806Z-9/16, K7806Z-3/4, K7806Z-13/16, K7806Z-11/16, K7806Z-1, K7806Z-7/8, K7806Z-15/16, K7806Z-5/8

1/2" Square Drive Deep Impact Socket Set with Metric Hex Profile and Phosphate Finish - 14 Pcs



DD/S14

14		4	DD/S14

K7806M-10, K7806M-11, K7806M-12, K7806M-13, K7806M-14, K7806M-15, K7806M-16, K7806M-17, K7806M-18, K7806M-19, K7806M-21, K7806M-22, K7806M-24, K7806M-27



1/2" Square Drive Mixed Impact Socket Set with Metric Hex Profile and Phosphate Finish - 20 Pcs



D-DD/

20		4	D-DD/S20

K7801M-10, K7801M-11, K7801M-12, K7801M-13, K7801M-14, K7801M-15, K7801M-16, K7801M-17, K7801M-18, K7801M-19



K7806M-10, K7806M-11, K7806M-12, K7806M-13, K7806M-14, K7806M-16, K7806M-17, K7806M-18, K7806M-19



1/2" Square Drive Impact Socket Set with Metric Hex Profile and Phosphate Finish - 10 Pcs



D/

10		6	D/S10

K7801M-10, K7801M-11, K7801M-12, K7801M-13, K7801M-14, K7801M-15, K7801M-16, K7801M-17, K7801M-18, K7801M-19

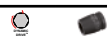

1/2" Square Drive Impact Socket Set with Metric Hex Profile and Phosphate Finish - 14 Pcs



D/S14

14		6	D/S14

K7801M-10, K7801M-11, K7801M-12, K7801M-13, K7801M-14, K7801M-15, K7801M-16, K7801M-17, K7801M-18, K7801M-19, K7801M-21, K7801M-22, K7801M-24, K7801M-27

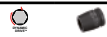

1/2" Square Drive Deep Impact Socket Set with Metric Hex Profile and Phosphate Finish - 10 Pcs



DD/

10		6	DD/S10

K7806M-10, K7806M-11, K7806M-12, K7806M-13, K7806M-14, K7806M-15, K7806M-16, K7806M-17, K7806M-18, K7806M-19

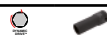

3/4" Square Drive Impact Sockets with Metric Hex Profile and Phosphate Finish



K8901M

Size	Part Number
17 mm	1 K8901M-17
18 mm	1 K8901M-18
19 mm	1 K8901M-19
21 mm	1 K8901M-21
22 mm	1 K8901M-22
23 mm	1 K8901M-23
24 mm	1 K8901M-24
27 mm	1 K8901M-27
28 mm	1 K8901M-28
29 mm	1 K8901M-29
30 mm	1 K8901M-30
32 mm	1 K8901M-32
33 mm	1 K8901M-33
34 mm	1 K8901M-34
36 mm	1 K8901M-36
38 mm	1 K8901M-38
41 mm	1 K8901M-41
46 mm	1 K8901M-46
50 mm	1 K8901M-50
55 mm	1 K8901M-55
60 mm	1 K8901M-60

SB: Retail pack on a plastic info card

3/4" Square Drive Impact Sockets with Metric Hex Profile Hang sell



SBK8901M

Size	Part Number
17 mm	1 SBK8901M-17
18 mm	1 SBK8901M-18
19 mm	1 SBK8901M-19
21 mm	1 SBK8901M-21
22 mm	1 SBK8901M-22
23 mm	1 SBK8901M-23
24 mm	1 SBK8901M-24
27 mm	1 SBK8901M-27
28 mm	1 SBK8901M-28
29 mm	1 SBK8901M-29
30 mm	1 SBK8901M-30
32 mm	1 SBK8901M-32
33 mm	1 SBK8901M-33
34 mm	1 SBK8901M-34
36 mm	1 SBK8901M-36
38 mm	1 SBK8901M-38

Size	Part Number
41 mm	1 SBK8901M-41
46 mm	1 SBK8901M-46
55 mm	1 SBK8901M-55
60 mm	1 SBK8901M-60
50 mm	1 SBK8901M-50

SB: Retail pack on a plastic info card

3/4" Square Drive Deep Impact Sockets with Metric Hex Profile and Phosphate Finish



K8906M

Size	Part Number
17 mm	1 K8906M-17
19 mm	1 K8906M-19
21 mm	1 K8906M-21
22 mm	1 K8906M-22
24 mm	1 K8906M-24
27 mm	1 K8906M-27
30 mm	1 K8906M-30
32 mm	1 K8906M-32
33 mm	1 K8906M-33
34 mm	1 K8906M-34
36 mm	1 K8906M-36
41 mm	1 K8906M-41
42 mm	1 K8906M-42
46 mm	1 K8906M-46

SB: Retail pack on a plastic info card

3/4" Square Drive Impact Sockets with Imperial Hex Profile and Phosphate Finish



K8901Z

Size	Part Number
11/16 in	1 K8901Z-11/16
3/4 in	1 K8901Z-3/4
13/16 in	1 K8901Z-13/16
7/8 in	1 K8901Z-7/8
15/16 in	1 K8901Z-15/16
1 in	1 K8901Z-1
1 1/16 in	1 K8901Z-1.1/16
1 1/8 in	1 K8901Z-1.1/8
1 3/16 in	1 K8901Z-1.3/16
1 1/4 in	1 K8901Z-1.1/4
1 5/16 in	1 K8901Z-1.5/16
1 3/8 in	1 K8901Z-1.3/8
1 7/16 in	1 K8901Z-1.7/16
1 1/2 in	1 K8901Z-1.1/2
1 9/16 in	1 K8901Z-1.9/16

Size	Part Number
1 5/8 in	1 K8901Z-1.5/8
1 11/16 in	1 K8901Z-1.11/16
1 3/4 in	1 K8901Z-1.3/4
1 13/16 in	1 K8901Z-1.13/16
1 7/8 in	1 K8901Z-1.7/8
1 15/16 in	1 K8901Z-1.15/16
2 in	1 K8901Z-2
2 1/16 in	1 K8901Z-2.1/16
2 3/16 in	1 K8901Z-2.3/16
2 1/4 in	1 K8901Z-2.1/4
2 3/8 in	1 K8901Z-2.3/8

SB: Retail pack on a plastic info card

3/4" Square Drive Deep Impact Sockets with Imperial Hex Profile and Phosphate Finish



K8906Z

Size	Part Number
3/4 in	1 K8906Z-3/4
13/16 in	1 K8906Z-13/16
7/8 in	1 K8906Z-7/8
15/16 in	1 K8906Z-15/16
1 mm	1 K8906Z-1
1 1/16 in	1 K8906Z-1.1/16
1.1/8 in	1 K8906Z-1.1/8
1.1/4 in	1 K8906Z-1.1/4
1.5/16 in	1 K8906Z-1.5/16
1.3/8 in	1 K8906Z-1.3/8
1.7/16 in	1 K8906Z-1.7/16
1.1/2 in	1 K8906Z-1.1/2
1.5/8 in	1 K8906Z-1.5/8
1.3/4 in	1 K8906Z-1.3/4
2 mm	1 K8906Z-2

SB: Retail pack on a plastic info card

3/4" Square Drive Impact Socket Drivers for Hex Head Screws Phosphate Finish



7993T

Size	Part Number
12 mm	1 7993T0120
14 mm	1 7993T0140
17 mm	1 7993T0170
19 mm	1 7993T0190
22 mm	1 7993T0220
24 mm	1 7993T0240

3/4" Square Drive Bit Holders with Phosphate Finish



K8909H

22 mm	3/4"	1	K8909H-5

3/4" Square Drive Ball Joint Sockets with Phosphate Finish



K8967S

3/4"	3/4"	1	K8967S

3/4" Square Drive Adaptors with Phosphate Finish



K8164F

1/2"	3/4"	1	K8164F

3/4" Square Drive to 1" Socket Increasing Adaptors with Phosphate Finish



K9564F

1"	3/4"	1	K9564F

3/4" Square Drive Extensions with Phosphate Finish



K8960F

175 mm	1	K8960F-2
250 mm	1	K8960F-3
325 mm	1	K8960F-4

Safety Clamping Springs for 3/4" Impact Socket



K560F-6

3/4"	17-46 mm	5	K560F-6

3/4" Square Drive Impact Socket Set with Metric Hex Profile and Phosphate Finish - 8 Pcs



K8901M/8

8	65 x 240 x 350 mm	1	K8901M/8

K8901M-27, K8901M-24, K8901M-21, K8901M-22, K8901M-30, K8901M-32, K8901M-36, K8901M-41

3/4" Square Drive Deep Impact Socket Set with Metric Hex Profile and Phosphate Finish - 8 Pcs



K8906M/8

8	80 x 250 x 315 mm	1	K8906M/8

K8906M-24, K8906M-27, K8906M-30, K8906M-41, K8906M-36, K8906M-21, K8906M-22, K8906M-32



3/4" Square Drive Impact Socket Set with Imperial Hex Profile and Phosphate Finish - 8 Pcs



K8901Z/8

8	80 x 250 x 310 mm	1	K8901Z/8

K8901Z-1.1/16, K8901Z-1, K8901Z-1.3/8, K8901Z-1.5/16, K8901Z-1.1/4, K8901Z-1.1/2, K8901Z-1.7/16, K8901Z-1.1/8

3/4" Square Drive Impact Socket Set with Imperial Hex Profile and Phosphate Finish - 18 Pcs



K8901Z/18

18	100 x 210 x 595 mm	1	K8901Z/18

K8901Z-11/16, K8901Z-3/4, K8901Z-13/16, K8901Z-7/8, K8901Z-15/16, K8901Z-1, K8901Z-1.1/16, K8901Z-1.1/8, K8901Z-1.3/16, K8901Z-1.1/4, K8901Z-1.5/16, K8901Z-1.3/8, K8901Z-1.7/16, K8901Z-1.1/2, K8901Z-1.9/16, K8901Z-1.5/8, K8901Z-1.11/16, K8901Z-1.3/4

3/4" Square Drive Deep Impact Socket Set with Imperial Hex Profile and Phosphate Finish - 8 Pcs



K8906Z/8

8	125 x 250 x 110 mm	1	K8906Z/8

K8906Z-1, K8906Z-1.1/16, K8906Z-1.1/8, K8906Z-1.1/4, K8906Z-1.5/16, K8906Z-1.3/8, K8906Z-1.7/16, K8906Z-1.1/2

1" Square Drive Impact Sockets with Metric Hex Profile and Phosphate Finish



K9501M

22 mm	1	K9501M-22
24 mm	1	K9501M-24
27 mm	1	K9501M-27
30 mm	1	K9501M-30
32 mm	1	K9501M-32
33 mm	1	K9501M-33
34 mm	1	K9501M-34
36 mm	1	K9501M-36
38 mm	1	K9501M-38
41 mm	1	K9501M-41
42 mm	1	K9501M-42
46 mm	1	K9501M-46
50 mm	1	K9501M-50
55 mm	1	K9501M-55
60 mm	1	K9501M-60
65 mm	1	K9501M-65
70 mm	1	K9501M-70
75 mm	1	K9501M-75
80 mm	1	K9501M-80
85 mm	1	K9501M-85

1" Square Drive Deep Impact Sockets with Metric Hex Profile and Phosphate Finish



K9506M

22 mm	1	K9506M-22
24 mm	1	K9506M-24
27 mm	1	K9506M-27
30 mm	1	K9506M-30
32 mm	1	K9506M-32
33 mm	1	K9506M-33
34 mm	1	K9506M-34
36 mm	1	K9506M-36
38 mm	1	K9506M-38
41 mm	1	K9506M-41
46 mm	1	K9506M-46
50 mm	1	K9506M-50
55 mm	1	K9506M-55
60 mm	1	K9506M-60

1" Square Drive Impact Sockets with Imperial Hex Profile and Phosphate Finish



K9501Z

1 in	1	K9501Z-1
1 1/16 in	1	K9501Z-1.1/16
1 1/8 in	1	K9501Z-1.1/8
1 3/16 in	1	K9501Z-1.3/16
1 1/4 in	1	K9501Z-1.1/4
1 5/16 in	1	K9501Z-1.5/16
1 3/8 in	1	K9501Z-1.3/8
1 7/16 in	1	K9501Z-1.7/16
1 1/2 in	1	K9501Z-1.1/2
1 9/16 in	1	K9501Z-1.9/16
1 5/8 in	1	K9501Z-1.5/8
1 11/16 in	1	K9501Z-1.11/16
1 3/4 in	1	K9501Z-1.3/4
1 13/16 in	1	K9501Z-1.13/16
1 7/8 in	1	K9501Z-1.7/8
15/16 in	1	K9501Z-1.15/16
2 in	1	K9501Z-2
2 1/8 in	1	K9501Z-2.1/8
2 3/16 in	1	K9501Z-2.3/16
2 1/4 in	1	K9501Z-2.1/4
2 5/16 in	1	K9501Z-2.5/16
2 9/16 in	1	K9501Z-2.9/16
2 3/4 in	1	K9501Z-2.3/4

1" Square Drive Deep Impact Sockets with Imperial Hex Profile and Phosphate Finish



K9506Z



1 in	1	K9506Z-1
1 1/16 in	1	K9506Z-1.1/16
1 3/16 in	1	K9506Z-1.3/16
1 1/4 in	1	K9506Z-1.1/4
1 7/16 in	1	K9506Z-1.7/16
1 1/2 in	1	K9506Z-1.1/2
1 5/8 in	1	K9506Z-1.5/8
1 13/16 in	1	K9506Z-1.13/16
1 7/8 in	1	K9506Z-1.7/8

1" Square Drive Adaptors with Phosphate Finish



K8964G



3/4"	1"	1	K8964G
------	----	---	--------

1" Square Drive Ball Joint Sockets with Phosphate Finish



K9567S



1"	1"	1	K9567S
----	----	---	--------

1" Square Drive Bit Holders with 22 mm Male Hex Drive with Phosphate Finish



K9509H5



22 mm	1"	1	K9509H5
-------	----	---	---------

1" to 1-1/2" Square Drive Adaptor with Phosphate Finish



K9895G



1 1/2"	1"	1	K9895G
--------	----	---	--------

Bits with 22 mm Male Hex Drive



K8909ML/K9509ML



12 mm	1	K8909ML-12
14 mm	1	K8909ML-14
17 mm	1	K8909ML-17
19 mm	1	K9509ML-19
22 mm	1	K9509ML-22
24 mm	1	K9509ML-24

1" Square Drive Socket Drivers for Hex Head Screws Phosphate Finish



7993M



17 mm	1	7993M0170
19 mm	1	7993M0190
22 mm	1	7993M0220
27 mm	1	7993M0270

1" Square Drive Extensions with Phosphate Finish



K9560G



100 mm	1	K9560G-0
125 mm	1	K9560G-1
175 mm	1	K9560G-2
325 mm	1	K9560G-3
300 mm	1	K9560G-4
400 mm	1	K9560G-5

Safety Clamping Springs for 1" and 1-1/2" Impact Socket



K560F-7/8



1"	19-70 mm	5	K560F-7
1 & 1 1/2"	75-80 & 46-90 mm	5	K560F-8



1-1/2" Square Drive Impact Sockets with Metric Hex Profile and Phosphate Finish



K9801M



46 mm	1	K9801M-46
50 mm	1	K9801M-50
55 mm	1	K9801M-55
60 mm	1	K9801M-60
65 mm	1	K9801M-65
70 mm	1	K9801M-70
75 mm	1	K9801M-75
80 mm	1	K9801M-80
85 mm	1	K9801M-85
90 mm	1	K9801M-90
95 mm	1	K9801M-95
100 mm	1	K9801M-100
105 mm	1	K9801M-105
110 mm	1	K9801M-110
115 mm	1	K9801M-115
120 mm	1	K9801M-120
125 mm	1	K9801M-125
130 mm	1	K9801M-130
135 mm	1	K9801M-135
140 mm	1	K9801M-140
145 mm	1	K9801M-145
150 mm	1	K9801M-150
155 mm	1	K9801M-155

1-1/2" Square Drive Impact Sockets with Imperial Hex Profile and Phosphate Finish



K9801Z



1 3/8 in	1	K9801Z-1.3/8
1 7/16 in	1	K9801Z-1.7/16
1 1/2 in	1	K9801Z-1.1/2
1 9/16 in	1	K9801Z-1.9/16
1 5/8 in	1	K9801Z-1.5/8
1 11/16 in	1	K9801Z-1.11/16
1 3/4 in	1	K9801Z-1.3/4
1 13/16 in	1	K9801Z-1.13/16
1 7/8 in	1	K9801Z-1.7/8
1 15/16 in	1	K9801Z-1.15/16
2 in	1	K9801Z-2
2 1/16 in	1	K9801Z-2.1/16
2 1/8 in	1	K9801Z-2.1/8
2 3/16 in	1	K9801Z-2.3/16
2 1/4 in	1	K9801Z-2.1/4
2 5/16 in	1	K9801Z-2.5/16
2 3/8 in	1	K9801Z-2.3/8
2 7/16 in	1	K9801Z-2.7/16
2 1/2 in	1	K9801Z-2.1/2
2 9/16 in	1	K9801Z-2.9/16
2 5/8 in	1	K9801Z-2.5/8
2 11/16 in	1	K9801Z-2.11/16
2 3/4 in	1	K9801Z-2.3/4
2 13/16 in	1	K9801Z-2.13/16
2 7/8 in	1	K9801Z-2.7/8
2 15/16 in	1	K9801Z-2.15/16
3 in	1	K9801Z-3
3 1/16 in	1	K9801Z-3.1/16
3 1/8 in	1	K9801Z-3.1/8
3 1/4 in	1	K9801Z-3.1/4
3 5/16 in	1	K9801Z-3.5/16
3 3/8 in	1	K9801Z-3.3/8
3 7/16 in	1	K9801Z-3.7/16
3 1/2 in	1	K9801Z-3.1/2
3 9/16 in	1	K9801Z-3.9/16
3 5/8 in	1	K9801Z-3.5/8
3 11/16 in	1	K9801Z-3.11/16
3 3/4 in	1	K9801Z-3.3/4
3 13/16 in	1	K9801Z-3.13/16
3 7/8 in	1	K9801Z-3.7/8
3 15/16 in	1	K9801Z-3.15/16
4 in	1	K9801Z-4
4 1/16 in	1	K9801Z-4.1/16
4 1/8 in	1	K9801Z-4.1/8
4 1/4 in	1	K9801Z-4.1/4
4 5/16 in	1	K9801Z-4.5/16
4 3/8 in	1	K9801Z-4.3/8
4 7/16 in	1	K9801Z-4.7/16
4 1/2 in	1	K9801Z-4.1/2
4 5/8 in	1	K9801Z-4.5/8
4 3/4 in	1	K9801Z-4.3/4

1-1/2" Square Drive Deep Impact Sockets with Imperial Hex Profile and Phosphate Finish



K9806Z



1 3/8 in	1	K9806Z-1.3/8
1 7/16 in	1	K9806Z-1.7/16
1 1/2 in	1	K9806Z-1.1/2
1 5/8 in	1	K9806Z-1.5/8
1 11/16 in	1	K9806Z-1.11/16
2 in	1	K9806Z-2
2 1/16 in	1	K9806Z-2.1/16
2 3/16 in	1	K9806Z-2.3/16
2 1/4 in	1	K9806Z-2.1/4
2 5/16 in	1	K9806Z-2.5/16
2 3/8 in	1	K9806Z-2.3/8
2 7/16 in	1	K9806Z-2.7/16
2 1/2 in	1	K9806Z-2.1/2
2 9/16 in	1	K9806Z-2.9/16
2 5/8 in	1	K9806Z-2.5/8
2 11/16 in	1	K9806Z-2.11/16
2 3/4 in	1	K9806Z-2.3/4
2 13/16 in	1	K9806Z-2.13/16
2 7/8 in	1	K9806Z-2.7/8
2 15/16 in	1	K9806Z-2.15/16
3 in	1	K9806Z-3
3 1/16 in	1	K9806Z-3.1/16
3 1/8 in	1	K9806Z-3.1/8
3 3/16 in	1	K9806Z-3.3/16
3 1/4 in	1	K9806Z-3.1/4
3 5/16 in	1	K9806Z-3.5/16
3 3/8 in	1	K9806Z-3.3/8
3 7/16 in	1	K9806Z-3.7/16
3 1/2 in	1	K9806Z-3.1/2
3 9/16 in	1	K9806Z-3.9/16
3 5/8 in	1	K9806Z-3.5/8
3 11/16 in	1	K9806Z-3.11/16
3 3/4 in	1	K9806Z-3.3/4
3 13/16 in	1	K9806Z-3.13/16
3 7/8 in	1	K9806Z-3.7/8
3 15/16 in	1	K9806Z-3.15/16
4 in	1	K9806Z-4
4 1/16 in	1	K9806Z-4.1/16
4 1/8 in	1	K9806Z-4.1/8
4 1/4 in	1	K9806Z-4.1/4
4 5/16 in	1	K9806Z-4.5/16
4 3/8 in	1	K9806Z-4.3/8
4 1/2 in	1	K9806Z-4.1/2
4 5/8 in	1	K9806Z-4.5/8
4 3/4 in	1	K9806Z-4.3/4

1-1/2" Square Drive Deep Impact Sockets with Metric Hex Profile and Phosphate Finish



K9806M



41 mm	1	K9806M-41
46 mm	1	K9806M-46
50 mm	1	K9806M-50
55 mm	1	K9806M-55
60 mm	1	K9806M-60
65 mm	1	K9806M-65
70 mm	1	K9806M-70
75 mm	1	K9806M-75
80 mm	1	K9806M-80
85 mm	1	K9806M-85
90 mm	1	K9806M-90
95 mm	1	K9806M-95
100 mm	1	K9806M-100
105 mm	1	K9806M-105
110 mm	1	K9806M-110
115 mm	1	K9806M-115
120 mm	1	K9806M-120

1-1/2" Square Drive Ball Joints with Phosphate Finish



K9867S

1 1/2	1 1/2	1	K9867S

1.1/2" Square Drive to 2.1/2" Socket Increasing Adaptors with Phosphate Finish



K9998H

2 1/2	1 1/2	1	K9998H

1-1/2" Square Drive Extensions with Phosphate Finish



K9860H

255 mm	1	K9860H-1
380 mm	1	K9860H-2
510 mm	1	K9860H-3

2.1/2" Square Drive to 1.1/2" Socket Reducing Adaptor with Phosphate Finish



K9899H

1 1/2	2 1/2	1	K9899H

1-1/2" Square Drive Adaptors with Phosphate Finish



K9598H

1	1 1/2	1	K9598H

Safety Clamping Springs for 1-1/2" Impact Socket



K560F-9

1 1/2"	95-120 mm	5	K560F-9





BAHCO®



Screwdrivers



ERGO™ SCREWDRIVERS WITH RIDGED RUBBER GRIP & COLOUR ID

ERGO™ TORX® Screwdriver Set with Rubber Grip - 5 Pcs



BE-9885

5 1 BE-9885

BE-8910, BE-8930, BE-8915, BE-8920, BE-8925

ERGO™ Slotted/Phillips Screwdriver Set with Rubber Grip - 6 Pcs



BE-9881

6 1 BE-9881

BE-8020, BE-8040
BE-8150, BE-8155
BE-8620, BE-8610

ERGO™ Slotted/Pozidriv Screwdriver Set with Rubber Grip - 6 Pcs



BE-9882

6 1 BE-9882

BE-8020, BE-8040
BE-8155, BE-8150
BE-8810, BE-8820

ERGO™ Slotted-Straight/Phillips/Pozidriv Screwdriver Set with Rubber Grip - 6 Pcs



BE-9884

6 1 BE-9884

BE-8611, BE-8621
BE-8040, BE-8241
BE-8811, BE-8821

ERGO™ Slotted/Phillips/Pozidriv Screwdriver Set with Rubber Grip - 6 Pcs



BE-9886

6 1 BE-9886

BE-8030
BE-8150
BE-8621, BE-8611
BE-8821, BE-8811

ERGO™ Slotted/Phillips/Pozidriv/TORX® Screwdriver Set with Rubber Grip - 6 Pcs



BE-9871



6

1 BE-9871

BE-8220S		
BE-8920, BE-8925		
BE-8820		
BE-8611, BE-8620		

ERGO™ Slotted/Phillips/Pozidriv/Torx® Screwdriver Set with Rubber Grip - 8 pcs



BE-9872



8

45 x 170 x 340 mm

595 g

1 BE-9872

BE-8925, BE-8920, BE-8915		
BE-8030		
BE-8821, BE-8811		
BE-8621, BE-8611		

ERGO™ Slotted/Phillips/Pozidriv/TORX® Screwdriver Set with Rubber Grip - 13 Pcs



BE-9875



13

1 BE-9875

BE-8040		
BE-8150, BE-8155		
BE-8621		
BE-8811, BE-8821		
BE-8910, BE-8915, BE-8920, BE-8925		
BE-8010S, BE-8230S		
BE-8811S		

ERGO™ Slotted/Phillips/Pozidriv/TORX® Screwdriver Set with Rubber Grip - 13 Pcs



BE-9879



13

1 BE-9879

BE-8010, BE-8040		
BE-8150		
BE-8611, BE-8621		
BE-8811, BE-8821		
BE-8910, BE-8915, BE-8920, BE-8925		
BE-8220SL		
BE-8620SL		



ERGO™ Slotted/Phillips/Pozidriv/TORX® Screwdriver Set with Rubber Grip - 15 Pcs



BE-9877



15 1 BE-9877

BE-8030		
BE-8150		
BE-8611, BE-8621		
BE-8811, BE-8821		
BE-8910, BE-8915, BE-8920, BE-8925		
BE-8220S, BE-8040S, BE-8050S		
BE-8611S, BE-8621S		

ERGO™ Slotted Straight Screwdrivers with Rubber Grip 2.0-6.5 mm



BE-8002 - BE-8252



Bit Size	Length	Shank Length	Shank Diameter	Quantity	Part No.
2.0 mm	60 mm	17 mm	103 mm	5	BE-8002
2.5 mm	60 mm	17 mm	103 mm	5	BE-8010
2.5 mm	75 mm	17 mm	103 mm	5	BE-8210
3.0 mm	60 mm	17 mm	103 mm	5	BE-8020
3.0 mm	75 mm	17 mm	103 mm	5	BE-8020L
3.0 mm	100 mm	17 mm	103 mm	5	BE-8022
3.0 mm	125 mm	17 mm	103 mm	5	BE-8220
3.0 mm	200 mm	17 mm	103 mm	5	BE-8225
3.5 mm	75 mm	17 mm	103 mm	5	BE-8030
3.5 mm	125 mm	17 mm	103 mm	5	BE-8230
3.5 mm	200 mm	17 mm	103 mm	5	BE-8235
4.0 mm	100 mm	20 mm	122 mm	5	BE-8040
4.0 mm	175 mm	20 mm	122 mm	5	BE-8240
5.5 mm	125 mm	27 mm	122 mm	5	BE-8241
5.5 mm	150 mm	27 mm	122 mm	5	BE-8242
5.5 mm	200 mm	27 mm	122 mm	5	BE-8250L
6.0 mm	150 mm	36 mm	122 mm	5	BE-8251
6.5 mm	150 mm	36 mm	122 mm	5	BE-8252

ERGO™ Slotted Flat Screwdrivers with Rubber Grip 5.5-10 mm



BE-8150 - BE-8258



Bit Size	Length	Shank Length	Shank Diameter	Quantity	Part No.
5.5 mm	100 mm	27 mm	122 mm	5	BE-8150
5.5 mm	150 mm	27 mm	122 mm	5	BE-8250
6.5 mm	125 mm	36 mm	122 mm	5	BE-8155
6.5 mm	150 mm	36 mm	122 mm	5	BE-8255
8 mm	150 mm	36 mm	122 mm	5	BE-8256
8 mm	175 mm	36 mm	122 mm	5	BE-8257
10 mm	200 mm	36 mm	161 mm	5	BE-8258

ERGO™ Hex Bolster Slotted Flat Screwdrivers with Rubber Grip 5.5-8 mm



BE-8158 - BE-8890



Bit Size	Length	Shank Length	Shank Diameter	Quantity	Part No.
5.5 mm	125 mm	27 mm	122 mm	5	BE-8158
6.5 mm	150 mm	36 mm	122 mm	5	BE-8159
8 mm	125 mm	36 mm	122 mm	5	BE-8160
8 mm	175 mm	36 mm	122 mm	5	BE-8260
8 mm	175 mm	36 mm	161 mm	5	BE-8865
10 mm	175 mm	36 mm	161 mm	5	BE-8870
12 mm	200 mm	36 mm	161 mm	5	BE-8880
14 mm	200 mm	36 mm	161 mm	5	BE-8890

ERGO™ Stubby Slotted Straight Screwdrivers with Rubber Grip 3.5-8.0 mm



BE-8330 - BE-8360



Bit Size	Length	Shank Length	Shank Diameter	Quantity	Part No.
3.5 mm	25 mm	36 mm	58 mm	5	BE-8330
4.0 mm	25 mm	36 mm	58 mm	5	BE-8340
5.0 mm	25 mm	36 mm	58 mm	5	BE-8350

Tip	Length	Shank	Handle	Weight	Part No.
5.0 mm	45 mm	36 mm	58 mm	5	BE-8450
6.5 mm	25 mm	36 mm	58 mm	5	BE-8355
6.0 mm	45 mm	36 mm	58 mm	5	BE-8455
8.0 mm	25 mm	36 mm	58 mm	5	BE-8360

ERGO™ Phillips Screwdrivers with Rubber Grip PH0-PH4



BE-8600 - BE-8624



Tip	Length	Shank	Handle	Weight	Part No.
PH 0	60 mm	17 mm	103 mm	5	BE-8600
PH 0	100 mm	17 mm	103 mm	5	BE-8605
PH 0	200 mm	17 mm	103 mm	5	BE-8608
PH 1	75 mm	27 mm	122 mm	5	BE-8610
PH 1	75 mm	20 mm	122 mm	5	BE-8611
PH 1	* 200 mm	27 mm	122 mm	5	BE-8610L
PH 2	100 mm	36 mm	122 mm	5	BE-8620
PH 2	100 mm	27 mm	122 mm	5	BE-8621
PH 2	150 mm	36 mm	122 mm	5	BE-8622
PH 2	* 200 mm	36 mm	122 mm	5	BE-8620L
PH 3	150 mm	36 mm	122 mm	5	BE-8623
PH 4	200 mm	36 mm	161 mm	5	BE-8624

ERGO™ Hex Bolster Phillips Screwdrivers with Rubber Grip PH1-PH4



BE-8628 - BE-8640



Tip	Length	Shank	Handle	Weight	Part No.
PH 1	100 mm	27 mm	122 mm	5	BE-8628
PH 2	125 mm	36 mm	122 mm	5	BE-8629
PH 3	150 mm	36 mm	122 mm	5	BE-8630
PH 4	200 mm	36 mm	161 mm	5	BE-8640

ERGO™ Stubby Phillips Screwdrivers with Rubber Grip PH1-PH2



BE-8601/BE-8602



Tip	Length	Shank	Handle	Weight	Part No.
PH 1	25 mm	36 mm	58 mm	5	BE-8601
PH 2	25 mm	36 mm	58 mm	5	BE-8602

ERGO™ Pozidriv Screwdrivers with Rubber Grip PZ0-PZ4



BE-8800 - BE-8824



Tip	Length	Shank	Handle	Weight	Part No.
PZ 0	60 mm	17 mm	103 mm	5	BE-8800
PZ 1	75 mm	27 mm	122 mm	5	BE-8810
PZ 1	75 mm	20 mm	122 mm	5	BE-8811
PZ 1	200 mm	27 mm	122 mm	5	BE-8810L
PZ 2	100 mm	36 mm	122 mm	5	BE-8820
PZ 2	100 mm	27 mm	122 mm	5	BE-8821
PZ 2	200 mm	36 mm	122 mm	5	BE-8820L
PZ 3	150 mm	36 mm	122 mm	5	BE-8823
PZ 4	200 mm	36 mm	161 mm	5	BE-8824

ERGO™ Hex Bolster Pozidriv Screwdrivers with Rubber Grip PZ1-PZ4



BE-8828 - BE-8840



Tip	Length	Shank	Handle	Weight	Part No.
PZ 1	100 mm	27 mm	122 mm	5	BE-8828
PZ 2	125 mm	36 mm	122 mm	5	BE-8829
PZ 3	150 mm	36 mm	122 mm	5	BE-8830
PZ 4	200 mm	36 mm	161 mm	5	BE-8840



ERGO™ Stubby Pozidriv Screwdrivers with Rubber Grip PZ1-PZ2



BE-8801/BE-8802



PZ 1	25 mm	36 mm	58 mm	5	BE-8801	
PZ 2	25 mm	36 mm	58 mm	5	BE-8802	

ERGO™ TORX® Screwdrivers with Rubber Grip T4-T45



BE-8904 - BE-8945



T 4	75 mm	17 mm	103 mm	5	BE-8904
T 5	75 mm	17 mm	103 mm	5	BE-8905
T 6	75 mm	17 mm	103 mm	5	BE-8906
T 7	75 mm	17 mm	103 mm	5	BE-8907
T 8	75 mm	17 mm	103 mm	5	BE-8908
T 9	75 mm	17 mm	103 mm	5	BE-8909
T 10	75 mm	20 mm	122 mm	5	BE-8910
T 15	100 mm	27 mm	122 mm	5	BE-8915
T 20	100 mm	27 mm	122 mm	5	BE-8920
T 25	125 mm	27 mm	122 mm	5	BE-8925
T 27	125 mm	27 mm	122 mm	5	BE-8927
T30	150 mm	36 mm	122 mm	5	BE-8930
T40	150 mm	36 mm	161 mm	5	BE-8940
T45	150 mm	36 mm	161 mm	5	BE-8945

ERGO™ TORX® Tamper-Resistant Screwdrivers with Rubber Grip TR7-TR40



BE-7907 - BE-7940



TR 7	75 mm	17 mm	103 mm	5	BE-7907
TR 8	75 mm	17 mm	103 mm	5	BE-7908
TR 9	75 mm	17 mm	103 mm	5	BE-7909

TR 10	75 mm	20 mm	122 mm	5	BE-7910
TR 15	100 mm	27 mm	122 mm	5	BE-7915
TR 20	100 mm	27 mm	122 mm	5	BE-7920
TR 25	125 mm	27 mm	122 mm	5	BE-7925
TR 27	125 mm	27 mm	122 mm	5	BE-7927
TR 30	150 mm	36 mm	122 mm	5	BE-7930
TR 40	150 mm	36 mm	161 mm	5	BE-7940

ERGO™ TORX® Ball End Screwdrivers with Rubber Grip T15-T40



BE-7515 - BE-7540



T 15	100 mm	27 mm	122 mm	5	BE-7515
T 20	100 mm	27 mm	122 mm	5	BE-7520
T 25	125 mm	27 mm	122 mm	5	BE-7525
T 27	125 mm	27 mm	122 mm	5	BE-7527
T 30	150 mm	36 mm	122 mm	5	BE-7530
T 40	150 mm	36 mm	122 mm	5	BE-7540

ERGO™ TORX® Plus Screwdrivers with Rubber Grip T15-T40



BE-7715 - BE-7740



T 15	100 mm	27 mm	122 mm	5	BE-7715
T 20	100 mm	27 mm	122 mm	5	BE-7720
T 25	125 mm	27 mm	122 mm	5	BE-7725
T 27	125 mm	27 mm	122 mm	5	BE-7727
T 30	150 mm	36 mm	122 mm	5	BE-7730
T 40	150 mm	36 mm	122 mm	5	BE-7740

ERGO™ Hex Screwdrivers with Rubber Grip Hex2-3 mm



BE-6902 - BE-6903

Hex Size	Length	Tip Length	Tip Diameter	Weight	Part No.
2 mm	75 mm	17 mm	103 mm	5	BE-6902
2.5 mm	75 mm	17 mm	103 mm	5	BE-6925
3 mm	75 mm	20 mm	122 mm	5	BE-6903

ERGO™ Hex Ball End Screwdrivers with Rubber Grip, metric 1.5-10 mm



BE-8715 - BE-8710

Hex Size	Length	Tip Length	Tip Diameter	Weight	Part No.
1.5 mm	60 mm	17 mm	103 mm	5	BE-8715
2 mm	100 mm	17 mm	103 mm	5	BE-8702
2.5 mm	100 mm	17 mm	103 mm	5	BE-8725
3 mm	100 mm	20 mm	122 mm	5	BE-8703
4 mm	100 mm	27 mm	122 mm	5	BE-8704
5 mm	100 mm	36 mm	122 mm	5	BE-8705
6 mm	125 mm	36 mm	122 mm	5	BE-8706
8 mm	150 mm	36 mm	122 mm	5	BE-8708
10 mm	150 mm	36 mm	161 mm	5	BE-8710

ERGO™ Hex Ball End Screwdrivers with Rubber Grip, inches 7/64-3/8"



BE-8700-7/64 - BE-8700-5/16

Hex Size	Length	Tip Length	Tip Diameter	Weight	Part No.
7/64 in	100 mm	20 mm	122 mm	5	BE-8700-7/64
5/32 in	100 mm	27 mm	122 mm	5	BE-8700-5/32
3/16 in	100 mm	27 mm	122 mm	5	BE-8700-3/16
7/32 in	100 mm	36 mm	122 mm	5	BE-8700-7/32
1/4 in	125 mm	36 mm	122 mm	5	BE-8700-1/4
5/16 in	150 mm	36 mm	122 mm	5	BE-8700-5/16
3/8 in	150 mm	36 mm	161 mm	5	BE-8700-3/8

ERGO™ Robertson - Square Screwdrivers with Rubber Grip #1-#3



BE-9001 - BE-9003

Size	Length	Tip Length	Tip Diameter	Weight	Part No.
# 1	80 mm	27 mm	122 mm	5	BE-9001
# 2	80 mm	27 mm	122 mm	5	BE-9002
# 3	100 mm	27 mm	122 mm	5	BE-9003

ERGO™ TRI-WING® Security Screwdrivers with Rubber Grip #0-#5



BE-9100 - BE-9105

Size	Length	Tip Length	Tip Diameter	Weight	Part No.
0	80 mm	20 mm	122 mm	5	BE-9100
1	80 mm	20 mm	122 mm	5	BE-9101
2	80 mm	27 mm	122 mm	5	BE-9102
3	80 mm	27 mm	122 mm	5	BE-9103
4	100 mm	27 mm	122 mm	5	BE-9104
5	100 mm	27 mm	122 mm	5	BE-9105

ERGO™ TORQ-SET® Security Screwdrivers with Rubber Grip #1-#10



BE-8080

Size	Length	Tip Length	Tip Diameter	Weight	Part No.
1	75 mm	27 mm	122 mm	5	BE-8080-1
2	75 mm	27 mm	122 mm	5	BE-8080-2
3	75 mm	27 mm	122 mm	5	BE-8080-3
4	75 mm	27 mm	122 mm	5	BE-8080-4
5	75 mm	27 mm	122 mm	5	BE-8080-5
6	75 mm	27 mm	122 mm	5	BE-8080-6
8	100 mm	27 mm	122 mm	5	BE-8080-8
10	100 mm	27 mm	122 mm	5	BE-8080-10



ERGO™ Round Tip Awl Screwdriver with Rubber Grip



BE-8985

6 mm	100 mm	27 mm	122 mm	5	BE-8985

ERGO™ Stubby Round Tip Awl Screwdriver with Rubber Grip 6 mm



BE-8986

4 mm	36 mm	50 mm	58 mm	5	BE-8986

ERGO™ Square Tip Reamer Screwdriver with Rubber Grip 6 mm



BE-8980

6 mm	100 mm	27 mm	122 mm	5	BE-8980

ERGO™ Hex Head Nut Drivers with Rubber Grip 4-7 mm



BE-6400M

4 mm	75 mm	20 mm	122 mm	5	BE-6400M-4
5 mm	75 mm	20 mm	122 mm	5	BE-6400M-5
5.5 mm	75 mm	20 mm	122 mm	5	BE-6400M-5.5
7 mm	75 mm	20 mm	122 mm	5	BE-6400M-7

ERGO™ Long Bore Hex Head Nut Drivers with Rubber Grip 3-14 mm



BE-78

3 mm	125 mm	20 mm	122 mm	5	BE-7803
3.5 mm	125 mm	20 mm	122 mm	5	BE-7835
4 mm	125 mm	20 mm	122 mm	5	BE-7804
4.5 mm	125 mm	20 mm	122 mm	5	BE-7845
5 mm	125 mm	20 mm	122 mm	5	BE-7805
5.5 mm	125 mm	20 mm	122 mm	5	BE-7855
6 mm	125 mm	20 mm	122 mm	5	BE-7806
7 mm	125 mm	27 mm	122 mm	5	BE-7807
8 mm	125 mm	27 mm	122 mm	5	BE-7808
9 mm	125 mm	36 mm	122 mm	5	BE-7809
10 mm	125 mm	36 mm	122 mm	5	BE-7810
11 mm	125 mm	36 mm	122 mm	5	BE-7811
12 mm	125 mm	36 mm	122 mm	5	BE-7812
13 mm	125 mm	36 mm	161 mm	5	BE-7813
14 mm	125 mm	36 mm	161 mm	5	BE-7814

ERGO™ Flexible Shaft Hex Head Nut Drivers with Rubber Grip 6-8 mm



BE-76

Bit Size	Length	Shaft Length	Hex Length	Quantity	Part No.
6 mm	150 mm	27 mm	122 mm	5	BE-7606
7 mm	150 mm	27 mm	122 mm	5	BE-7607
8 mm	150 mm	27 mm	122 mm	5	BE-7608

1/4" Hex Blades for Slotted Head Screw - 100 mm



8020-2P - 8252-2P

Blade Size	Blade Width	Quantity	Part No.
3.0 mm	0.5 mm	1	8020-2P
3.5 mm	0.6 mm	1	8030-2P
4.0 mm	0.8 mm	1	8040-2P
5.5 mm	1.0 mm	1	8242-2P
6.5 mm	1.2 mm	1	8252-2P

ERGO™ Bit Holder with Rubber Grip for 1/4" Hex Bit



BE-8577

Bit Size	Length	Shaft Length	Hex Length	Quantity	Part No.
1/4 in	118 mm	36 mm	122 mm	5	BE-8577

1/4" Hex Blades for Phillips Head Screw - 100 mm



8600-2P - 8630-2P

Blade Size	Quantity	Part No.
0	1	8600-2P
1	1	8610-2P
2	1	8620-2P
3	1	8630-2P

ERGO™ Bit Holder Screwdriver with quick release system for 1/4" Hex Blades



BE-8575

Bit Size	Length	Quantity	Part No.
1/4 in	122 mm	1	BE-8575

1/4" Hex Blades for Pozidriv Head Screw - 100 mm



8800-2P - 8830-2P

Blade Size	Quantity	Part No.
0	1	8800-2P
1	1	8810-2P
2	1	8820-2P
3	1	8830-2P



1/4" Hex Blades for TORX® Head Screw - 100 mm



8910-2P - 8940-2P



10	1	8910-2P
15	1	8915-2P
20	1	8920-2P
25	1	8925-2P
27	1	8927-2P
30	1	8930-2P
40	1	8940-2P

1/4" Hex Blades for Phillips Head Screw - 300 mm



8610L-2P - 8620L-2P



1	1	8610L-2P
2	1	8620L-2P

1/4" Hex Blades for Hex Ball Head Screw - 100 mm



8703-2P - 8706-2P



3 mm	1	8703-2P
4 mm	1	8704-2P
5 mm	1	8705-2P
6 mm	1	8706-2P

1/4" Hex Blades for Pozidriv Head Screw - 300 mm



8810L-2P - 8820L-2P



1	1	8810L-2P
2	1	8820L-2P

1/4" Hex Blades for Slotted Head Screw - 300 mm



8040L-2P - 8252L-2P



0.8 mm	4.0 mm	1 8040L-2P
1.0 mm	5.5 mm	1 8242L-2P
1.2 mm	6.5 mm	1 8252L-2P

1/4" Hex Blades for TORX® Head Screw - 300 mm



8915L-2P - 8930L-2P



T15	1	8915L-2P
T20	1	8920L-2P
T25	1	8925L-2P
T27	1	8927L-2P
T30	1	8930L-2P

1/4" Hex Blades for Phillips Head Screw - 400 mm



8620XL-1P - 8630XL-1P



2	1	8620XL-1P
3	1	8630XL-1P

1/4" Hex Blades for Pozidriv Head Screw - 400 mm



8820XL-1P - 8830XL-1P



2	1	8820XL-1P
3	1	8830XL-1P

1/4" Hex Blades for Slotted Head Screw - 400 mm



8252XL-1P



1.2 mm	6.5 mm	1	8252XL-1P
--------	--------	---	-----------

ERGO™ Bit Holder Screwdrivers with quick release system and Interchangeable Blades Set - 7 Pcs



BE-8571



7	85 x 85 x 210 mm	1	BE-8571
---	------------------	---	---------

BE-8575		
8242-2P, 8252-2P		
8610-2P, 8620-2P		
8810-2P, 8820-2P		

ERGO™ Bit Holder Screwdriver with quick release system and Interchangeable Blades Set - 9 Pcs



BE-8572



9	85 x 80 x 210 mm	1	BE-8572
---	------------------	---	---------

BE-8575		
8242-2P, 8252-2P		
8610-2P, 8620-2P		
8810-2P, 8820-2P		
8910-2P, 8915-2P		



ERGO™ Bit Holder Screwdrivers with quick release system and TORX® Interchangeable Blades Set - 8 Pcs



BE-8573



8	85 x 85 x 210 mm	1	BE-8573

BE-8575		
8910-2P, 8915-2P, 8920-2P, 8925-2P, 8927-2P, 8930-2P, 8940-2P		

ERGO™ Bit Holder Screwdrivers with quick release bit holder and Interchangeable Blades Set - 8 Pcs



BE-8574



8	85 x 85 x 210 mm	1	BE-8574

BE-8575		
8610-2P, 8620-2P		
8040-2P		
8820-2P		
8920-2P, 8925-2P, 8930-2P		

ERGO™ Bit Holder Screwdriver with quick release system and Interchangeable Blades/Bits Set - 22 Pcs



BE-8576



23		1 BE-8576

BE-8575		
8030-2P, 8040-2P, 8242-2P, 8252-2P		
8810-2P, 8820-2P, 8830-2P		
8610-2P, 8620-2P, 8630-2P		
8910-2P, 8915-2P, 8925-2P, 8930-2P, 8940-2P		
59S/H2, 59S/H3, 59S/H5, 59S/H4, 59S/H6		
59S/H8		

ERGO™ SCREWDRIVERS WITH IMPACT GRIP

ERGO™ Through Blade Slotted/Phillips/Hex Screwdriver Set with Impact Grip - 6 Pcs



BE-9881TB



6		1 BE-9881TB

BE-8135TB, BE-8145TB, BE-8150TB, BE-8155TB		
BE-8610TB, BE-8620TB		

ERGO™ Through Blade Slotted/Pozidriv/Hex Screwdriver Set with Impact Grip - 6 Pcs



BE-9882TB



6



1 BE-9882TB

BE-8135TB, BE-8145TB, BE-8150TB, BE-8155TB



BE-8810TB, BE-8820TB



ERGO™ Through Blade TORX®/Hex Screwdriver Set with Impact Grip - 5 Pcs



BE-9885TB



5



1 BE-9885TB

BE-8915TB, BE-8920TB, BE-8925TB, BE-8930TB, BE-8940TB



ERGO™ Through Blade Slotted Screwdrivers with Impact Grip 3.5-6.5 mm



BE-8135TB - BE-8262TB



3.5 mm	75 mm	27 mm	122 mm	10	BE-8135TB
4.5 mm	100 mm	27 mm	122 mm	10	BE-8145TB
5.5 mm	100 mm	27 mm	122 mm	10	BE-8150TB

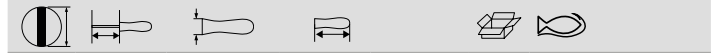

6.5 mm	125 mm	36 mm	122 mm	10	BE-8155TB
8 mm	150 mm	36 mm	122 mm	10	BE-8256TB
10 mm	175 mm	36 mm	122 mm	10	BE-8258TB
12 mm	200 mm	36 mm	122 mm	10	BE-8262TB
3.5 mm	75 mm	27 mm	122 mm	1	SBE-8135TB
4.5 mm	100 mm	27 mm	122 mm	1	SBE-8145TB
5.5 mm	100 mm	27 mm	122 mm	1	SBE-8150TB
6.5 mm	125 mm	36 mm	122 mm	1	SBE-8155TB

ERGO™ Through Blade Phillips Screwdrivers with Impact Grip PH1-PH4



BE-8610TB - BE-8624TB



PH 1	100 mm	27 mm	122 mm	10	BE-8610TB
PH 2	125 mm	36 mm	122 mm	10	BE-8620TB
PH 3	150 mm	36 mm	122 mm	10	BE-8623TB
PH 4	175 mm	36 mm	122 mm	10	BE-8624TB
PH 1	100 mm	27 mm	122 mm	1	SBE-8610TB
PH 2	125 mm	36 mm	122 mm	1	SBE-8620TB

ERGO™ Through Blade Pozidriv Screwdrivers with Impact Grip PZ1-PZ4



BE-8810TB - BE-8824TB

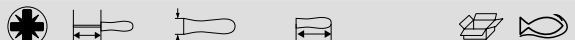

PZ 1	100 mm	27 mm	122 mm	10	BE-8810TB
PZ 2	125 mm	36 mm	122 mm	10	BE-8820TB
PZ 3	150 mm	36 mm	122 mm	10	BE-8823TB
PZ 4	175 mm	36 mm	122 mm	10	BE-8824TB
PZ 1	100 mm	27 mm	122 mm	1	SBE-8810TB
PZ 2	125 mm	36 mm	122 mm	1	SBE-8820TB



ERGO™ Through Blade TORX® Screwdrivers with Impact Grip T10-T40



BE-8910TB - BE-8940TB

T 10	75 mm	27 mm	122 mm	5	BE-8910TB	
T 15	100 mm	27 mm	122 mm	5	BE-8915TB	
T 20	100 mm	27 mm	122 mm	5	BE-8920TB	
T 25	100 mm	27 mm	122 mm	5	BE-8925TB	
T 27	125 mm	27 mm	122 mm	5	BE-8927TB	
T 30	150 mm	36 mm	122 mm	5	BE-8930TB	
T 40	150 mm	36 mm	122 mm	5	BE-8940TB	
T 15	100 mm	27 mm	122 mm	1	SBE-8915TB	
T 20	100 mm	27 mm	122 mm	1	SBE-8920TB	
T 25	100 mm	27 mm	122 mm	1	SBE-8925TB	
T 30	150 mm	36 mm	122 mm	1	SBE-8930TB	
T 40	150 mm	36 mm	122 mm	1	SBE-8940TB	

BAHCOFIT SCREWDRIVERS WITH GROOVED RUBBER GRIP

BahcoFit Slotted/Phillips Screwdriver Set with Rubber Grip - 2 Pcs



B219.002



2	1	B219.002

B191.040.100		
B192.001.100		

BahcoFit Slotted/Phillips Screwdriver Set with Rubber Grip - 2 Pcs



B219.012



2	1	B219.012



B190.055.125		
B192.002.125		

BahcoFit Slotted/Phillips Screwdriver Set with Rubber Grip - 4 Pcs



B219.004



4	1	B219.004

B191.030.100, B191.055.125		
B192.001.100, B192.002.125		

BahcoFit Phillips Screwdriver Set with Rubber Grip - 4 Pcs



B219.014



4	1	B219.014

B192.000.075, B192.001.100, B192.002.125, B192.003.150		
--	--	--

BahcoFit Slotted/Phillips Screwdriver Set with Rubber Grip - 5 Pcs



B219.005



5

1 B219.005

B191.030.075, B191.040.100



B190.055.125



B192.001.100, B192.002.125



BahcoFit Slotted/Pozidriv Screwdriver Set with Rubber Grip - 5 Pcs



B219.015

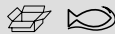

5

1 B219.015

B191.030.075, B191.040.100



B190.055.125



B193.001.100, B193.002.125



BahcoFit TORX® Screwdriver Set with Rubber Grip - 5 Pcs



B219.025



5

1 B219.025

B194.010.075, B194.015.100, B194.020.100, B194.025.125,
B194.030.150



BahcoFit Tamper-Resistant TORX® Screwdriver Set with Rubber Grip - 5 Pcs



B219.035



5

1 B219.035

B141.010.075, B141.015.100, B141.020.100, B141.025.125,
B141.030.150



BahcoFit Slotted Screwdriver Set with Rubber Grip - 5 Pcs



B219.045



5

1 B219.045

B191.030.100, B191.040.125



B190.055.125, B190.065.150, B190.080.175



BahcoFit Slotted/Phillips Screwdriver Set with Rubber Grip - 6 Pcs



B219.006



6

1 B219.006

B191.030.075, B191.040.100



B190.055.125, B190.065.125



B192.001.100, B192.002.125



BahcoFit Slotted/Pozidriv Screwdriver Set with Rubber Grip - 6 Pcs



B219.016



6

1 B219.016

B191.030.075, B191.040.100

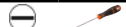

B190.055.125, B190.065.125



B193.001.100, B193.002.125



BahcoFit Slotted/Phillips/Pozidriv Screwdriver Set with Rubber Grip - 6 Pcs



B219.026



6

1 B219.026

B191.030.075, B191.040.100



B192.001.100, B192.002.125



B193.001.100, B193.002.125



BahcoFit Pozidriv/TORX® Screwdriver Set with Rubber Grip - 7 Pcs



B219.007



7

1 B219.007

B193.001.100, B193.002.125



B194.010.075, B194.015.100, B194.020.100, B194.025.125,



B194.030.150

BahcoFit Slotted/Phillips Screwdriver Set with Rubber Grip - 7 Pcs



B219.017



7

1 B219.017

B191.035.100, B191.040.100



B190.055.125, B190.065.150, B190.080.150



B192.001.100, B192.002.125



BahcoFit TORX® Screwdriver Set with Rubber Grip - 7 Pcs



B219.027



7

1 B219.027

B194.010.075, B194.015.100, B194.020.100, B194.025.125,
B194.027.125, B194.030.150, B194.040.150



BahcoFit Slotted/Phillips Screwdriver Set with Rubber Grip - 8 Pcs



B219.008



8

1 B219.008

B191.040.100, B191.055.125



B190.065.150, B190.080.175



B192.001.100, B192.002.125



B195.060.025



B195.002.025



BahcoFit Slotted/Phillips/Pozidriv/TORX® Screwdriver Set with Rubber Grip - 10 Pcs



B219.110



10

1 B219.110

B190.055.100



B192.002.125



B193.002.125



B194.010.075, B194.015.100, B194.020.100



B196.025.075, B196.040.100



B142.001.080



806-1-1



BahcoFit Torx® Screwdriver Set with Rubber Grip - 10 pcs



B219.210



10

4.5 x 33 x 17 mm

1 B219.210

B194.006.075, B194.008.075, B194.009.075, B194.010.075,
B194.015.100, B194.020.100, B194.025.125, B194.027.125,
B194.030.150, B194.040.150



BahcoFit Slotted/Phillips/Pozidriv/Robertson Screwdriver Set with Rubber Grip - 10 Pcs



B219.010



10

1 B219.010

B191.030.075



B190.055.100, B190.065.125, B190.080.150



B192.001.100, B192.002.125, B192.003.150



B195.902.025



B144.001.100, B144.002.125



BahcoFit Slotted Flat Screwdrivers with Rubber Grip 4.0-14 mm



B190



4 mm	75 mm	24.5 mm	95 mm	10	B190.040.075
4 mm	100 mm	24.5 mm	95 mm	10	B190.040.100
5.5 mm	100 mm	30 mm	105 mm	10	B190.055.100
5.5 mm	125 mm	30 mm	105 mm	10	B190.055.125
6.5 mm	125 mm	34 mm	117 mm	10	B190.065.125
6.5 mm	150 mm	34 mm	117 mm	10	B190.065.150
8 mm	150 mm	34 mm	117 mm	10	B190.080.150
8 mm	175 mm	34 mm	117 mm	10	B190.080.175
10 mm	200 mm	34 mm	117 mm	10	B190.100.200
12 mm	250 mm	34 mm	117 mm	10	B190.120.250
14 mm	250 mm	34 mm	117 mm	10	B190.140.250

4 mm	75 mm	24.5 mm	95 mm	1	SB190.040.075
4 mm	100 mm	24.5 mm	95 mm	1	SB190.040.100
5.5 mm	100 mm	30 mm	105 mm	1	SB190.055.100
5.5 mm	125 mm	30 mm	105 mm	1	SB190.055.125
6.5 mm	125 mm	34 mm	117 mm	1	SB190.065.125
6.5 mm	150 mm	34 mm	117 mm	1	SB190.065.150
8 mm	150 mm	34 mm	117 mm	1	SB190.080.150
8 mm	175 mm	34 mm	117 mm	1	SB190.080.175
10 mm	200 mm	34 mm	117 mm	1	SB190.100.200
12 mm	250 mm	34 mm	117 mm	1	SB190.120.250
14 mm	250 mm	34 mm	117 mm	1	SB190.140.250

BahcoFit Slotted Straight Screwdrivers with Rubber Grip 2.5-6.5 mm



B191



2.5 mm	75 mm	24.5 mm	95 mm	10	B191.025.075
3 mm	75 mm	24.5 mm	95 mm	10	B191.030.075
3 mm	100 mm	24.5 mm	95 mm	10	B191.030.100
3 mm	200 mm	24.5 mm	95 mm	10	B191.030.200
3.5 mm	100 mm	24.5 mm	95 mm	10	B191.035.100
4 mm	100 mm	24.5 mm	95 mm	10	B191.040.100
4 mm	125 mm	24.5 mm	95 mm	10	B191.040.125
4 mm	250 mm	24.5 mm	95 mm	10	B191.040.250
5.5 mm	125 mm	30 mm	105 mm	10	B191.055.125
5.5 mm	150 mm	30 mm	105 mm	10	B191.055.150
5.5 mm	300 mm	30 mm	105 mm	10	B191.055.300
6.5 mm	150 mm	34 mm	117 mm	10	B191.065.150
6.5 mm	300 mm	34 mm	117 mm	10	B191.065.300

2.5 mm	75 mm	24.5 mm	95 mm	1	SB191.025.075
3 mm	75 mm	24.5 mm	95 mm	1	SB191.030.075
3 mm	100 mm	24.5 mm	95 mm	1	SB191.030.100
3 mm	200 mm	24.5 mm	95 mm	1	SB191.030.200
3.5 mm	100 mm	24.5 mm	95 mm	1	SB191.035.100
4 mm	100 mm	24.5 mm	95 mm	1	SB191.040.100
4 mm	125 mm	24.5 mm	95 mm	1	SB191.040.125
4 mm	250 mm	24.5 mm	95 mm	1	SB191.040.250
5.5 mm	125 mm	30 mm	105 mm	1	SB191.055.125
5.5 mm	150 mm	30 mm	105 mm	1	SB191.055.150
5.5 mm	300 mm	30 mm	105 mm	1	SB191.055.300
6.5 mm	150 mm	34 mm	117 mm	1	SB191.065.150
6.5 mm	300 mm	34 mm	117 mm	1	SB191.065.300

BahcoFit Stubby Slotted Straight Screwdrivers with Rubber Grip 4.0-6.0 mm



B195



4 mm	25 mm	33 mm	60 mm	10	B195.040.025
5.0 mm	25 mm	33 mm	60 mm	10	B195.050.025
6 mm	25 mm	33 mm	60 mm	10	B195.060.025
4 mm	25 mm	33 mm	60 mm	1	SB195.040.025
5 mm	25 mm	33 mm	60 mm	1	SB195.050.025
6 mm	25 mm	33 mm	60 mm	1	SB195.060.025

BahcoFit Phillips Screwdrivers with Rubber Grip PH0-PH4



B192



PH0	75 mm	24.5 mm	95 mm		10	B192.000.075
PH0	200 mm	24.5 mm	95 mm		10	B192.000.200
PH1	100 mm	30 mm	105 mm		10	B192.001.100
PH1	250 mm	30 mm	105 mm		10	B192.001.250
PH2	125 mm	34 mm	117 mm		10	B192.002.125
PH2	150 mm	34 mm	117 mm		10	B192.002.150
PH2	300 mm	34 mm	117 mm		10	B192.002.300
PH3	150 mm	34 mm	117 mm		10	B192.003.150
PH4	200 mm	34 mm	117 mm		10	B192.004.200
PH0	75 mm	24.5 mm	95 mm		1	SB192.000.075
PH0	200 mm	24.5 mm	95 mm		1	SB192.000.200
PH1	100 mm	30 mm	105 mm		1	SB192.001.100
PH1	250 mm	30 mm	105 mm		1	SB192.001.250
PH2	125 mm	34 mm	117 mm		1	SB192.002.125
PH2	300 mm	34 mm	117 mm		1	SB192.002.300
PH3	150 mm	34 mm	117 mm		1	SB192.003.150
PH4	200 mm	34 mm	117 mm		1	SB192.004.200

BahcoFit Stubby Phillips Screwdrivers with Rubber Grip PH1-PH2



B195PH



PH1	25 mm	33 mm	60 mm		10	B195.001.025
PH2	25 mm	33 mm	60 mm		10	B195.002.025
PH1	25 mm	33 mm	60 mm		1	SB195.001.025
PH2	25 mm	33 mm	60 mm		1	SB195.002.025

BahcoFit Pozidriv Screwdrivers with Rubber Grip PZ0-PZ4



B193



PZ0	75 mm	24.5 mm	95 mm		10	B193.000.075
PZ1	100 mm	30 mm	105 mm		10	B193.001.100
PZ2	125 mm	34 mm	117 mm		10	B193.002.125
PZ3	150 mm	34 mm	117 mm		10	B193.003.150
PZ4	200 mm	34 mm	117 mm		10	B193.004.200
PZ0	75 mm	24.5 mm	95 mm		1	SB193.000.075
PZ1	100 mm	30 mm	105 mm		1	SB193.001.100
PZ2	125 mm	34 mm	117 mm		1	SB193.002.125
PZ3	150 mm	34 mm	117 mm		1	SB193.003.150
PZ4	200 mm	34 mm	117 mm		1	SB193.004.200

BahcoFit Stubby Pozidriv Screwdrivers with Rubber Grip PZ1-PZ2



B195PZ



PZ1	25 mm	33 mm	60 mm		10	B195.901.025
PZ2	25 mm	33 mm	60 mm		10	B195.902.025
PZ1	25 mm	33 mm	60 mm		1	SB195.901.025
PZ2	25 mm	33 mm	60 mm		1	SB195.902.025



BahcoFit TORX® Screwdrivers with Rubber Grip T4-T45



TR10		75 mm	24.5 mm	95 mm	1	SB141.010.075
TR15		100 mm	24.5 mm	95 mm	1	SB141.015.100
TR20		100 mm	24.5 mm	95 mm	1	SB141.020.100
TR25		125 mm	30 mm	105 mm	1	SB141.025.125
TR27		125 mm	30 mm	105 mm	1	SB141.027.125
TR30		150 mm	34 mm	117 mm	1	SB141.030.150
TR40		150 mm	34 mm	117 mm	1	SB141.040.150

B194



T4		75 mm	24.5 mm	95 mm	10	B194.004.075
T5		75 mm	24.5 mm	95 mm	10	B194.005.075
T6		75 mm	24.5 mm	95 mm	10	B194.006.075
T7		75 mm	24.5 mm	95 mm	10	B194.007.075
T8		75 mm	24.5 mm	95 mm	10	B194.008.075
T9		75 mm	24.5 mm	95 mm	10	B194.009.075
T10		75 mm	24.5 mm	95 mm	10	B194.010.075
T15		100 mm	24.5 mm	95 mm	10	B194.015.100
T20		100 mm	24.5 mm	95 mm	10	B194.020.100
T25		125 mm	30 mm	105 mm	10	B194.025.125
T27		125 mm	30 mm	105 mm	10	B194.027.125
T30		150 mm	34 mm	117 mm	10	B194.030.150
T40		150 mm	34 mm	117 mm	10	B194.040.150
T45		150 mm	34 mm	117 mm	5	B194.045.150

BahcoFit Hex Ball End Screwdrivers with Rubber Grip Hex2-8 mm



B143

2		100 mm	24.5 mm	95 mm	5	B143.020.100
2.5		100 mm	24.5 mm	95 mm	10	B143.025.100
3		100 mm	24.5 mm	95 mm	10	B143.030.100
4		100 mm	24.5 mm	95 mm	10	B143.040.100
5		100 mm	30 mm	105 mm	10	B143.050.100
6		125 mm	34 mm	117 mm	10	B143.060.125
8		150 mm	34 mm	117 mm	5	B143.080.150

BahcoFit Tamper-Resistant TORX® Screwdrivers with Rubber Grip TR7-TR40



B141

TR7		75 mm	24.5 mm	95 mm	5	B141.007.075
TR8		75 mm	24.5 mm	95 mm	5	B141.008.075
TR9		75 mm	24.5 mm	95 mm	5	B141.009.075
TR10		75 mm	24.5 mm	95 mm	5	B141.010.075
TR15		100 mm	24.5 mm	95 mm	5	B141.015.100
TR20		100 mm	24.5 mm	95 mm	5	B141.020.100
TR25		125 mm	30 mm	105 mm	5	B141.025.125
TR27		125 mm	30 mm	105 mm	5	B141.027.125
TR30		150 mm	34 mm	117 mm	5	B141.030.150
TR40		150 mm	34 mm	117 mm	5	B141.040.150

BahcoFit Robertson Square Screwdrivers with Rubber Grip #1-#3



B144

#1		100 mm	24.5 mm	95 mm	5	B144.001.100
#2		125 mm	30 mm	105 mm	5	B144.002.125
#3		150 mm	34 mm	117 mm	5	B144.003.150

BahcoFit Awl with Rubber Grip for Pre-Punching/Drilling Holes 6 mm



B145

Ø	Length	Tip Length	Tip Dia	Weight	Part No.
6 mm	100 mm	30 mm	105 mm	5	B145.006.100
6 mm	100 mm	30 mm	105 mm	1	SB145.006.100

BahcoFit Reamers with Rubber Grip for Enlarging/Drilling Holes 6 mm



B146

Ø	Length	Tip Length	Tip Dia	Weight	Part No.
6 mm	100 mm	30 mm	105 mm	5	B146.006.100
6 mm	100 mm	30 mm	105 mm	1	SB146.006.100

BahcoFit Stubby Awl with Rubber Grip 6 mm



B195Awl

Ø	Length	Tip Length	Tip Dia	Weight	Part No.
4 mm	50 mm	33 mm	60 mm	5	B195.006.050
4 mm	50 mm	33 mm	60 mm	1	SB195.006.050

BahcoFit Hex Head Nut Drivers with Rubber Grip 4-14 mm



B198

Ø	Length	Tip Length	Tip Dia	Weight	Part No.
4 mm	125 mm	24.5 mm	95 mm	5	B198.040.125
4.5 mm	125 mm	24.5 mm	95 mm	5	B198.045.125
5 mm	150 mm	30 mm	105 mm	5	B198.050.150
5.5 mm	150 mm	30 mm	105 mm	5	B198.055.150
6 mm	150 mm	30 mm	105 mm	5	B198.060.150
7 mm	150 mm	34 mm	117 mm	5	B198.070.150
8 mm	150 mm	34 mm	117 mm	5	B198.080.150
9 mm	150 mm	34 mm	117 mm	5	B198.090.150
10 mm	150 mm	34 mm	117 mm	5	B198.100.150
11 mm	150 mm	34 mm	117 mm	5	B198.110.150
12 mm	150 mm	34 mm	117 mm	5	B198.120.150
13 mm	150 mm	34 mm	117 mm	5	B198.130.150
14 mm	150 mm	34 mm	117 mm	5	B198.140.150
4 mm	125 mm	24.5 mm	95 mm	1	SB198.040.125
4.5 mm	125 mm	24.5 mm	95 mm	1	SB198.045.125
5 mm	150 mm	30 mm	105 mm	1	SB198.050.150
5.5 mm	150 mm	30 mm	105 mm	1	SB198.055.150
6 mm	150 mm	30 mm	105 mm	1	SB198.060.150
7 mm	150 mm	34 mm	117 mm	1	SB198.070.150
8 mm	150 mm	34 mm	117 mm	1	SB198.080.150
9 mm	150 mm	34 mm	117 mm	1	SB198.090.150
10 mm	150 mm	34 mm	117 mm	1	SB198.100.150
11 mm	150 mm	34 mm	117 mm	1	SB198.110.150
12 mm	150 mm	34 mm	117 mm	1	SB198.120.150
13 mm	150 mm	34 mm	117 mm	1	SB198.130.150
14 mm	150 mm	34 mm	117 mm	1	SB198.140.150



BahcoFit Flexible Shaft Hex Head Nut Driver with Rubber Grip 6-8 mm



B198F



6 mm	150 mm	34 mm	117 mm	5	B198.060.150F	
7 mm	150 mm	34 mm	117 mm	5	B198.070.150F	
8 mm	150 mm	34 mm	117 mm	5	B198.080.150F	
6 mm	150 mm	34 mm	117 mm	1	SB198.060.150F	
7 mm	150 mm	34 mm	117 mm	1	SB198.070.150F	
8 mm	150 mm	34 mm	117 mm	1	SB198.080.150F	

SCREWDRIVERS WITH RUBBERED GRIP

Slotted/Phillips Screwdriver Set with Rubber Grip - 3 Pcs



600-3



3	1 600-3

613-3-100		
611-5.5-125		
615-1-100		

Slotted/Phillips Screwdriver Set with Rubber Grip - 4 Pcs



602-4-LA



4	1 602-4-LA

613-3-100		
611-5.5-100		
615-1-100, 615-2-125		

Slotted/Phillips Screwdriver Set with Rubber Grip - 5 Pcs



604-5



5	1 604-5

613-3-100		
611-4-100, 611-6.5-125		
615-1-100, 615-2-125		

TORX® Screwdriver Set with Rubber Grip - 5 Pcs



612-5



5



1 612-5

618-10-75, 618-15-100, 618-20-100, 618-25-125, 618-30-150



Slotted/Phillips/Pozidriv Screwdriver Set with Rubber Grip 3-4 mm/
PH1-PH2/PZ1-PZ2 - 6 Pcs



605-6



6



1 605-6

613-3-75, 613-4-100



615-1-100, 615-2-125



616-1-100, 616-2-125



Slotted/Phillips Screwdriver Set with Rubber Grip 5.5-6.5 mm/3-4 mm/
PH1-PH2 - 6 Pcs



606-6



6



1 606-6

611-5.5-100, 611-6.5-125



613-3-75, 613-4-100



615-1-100, 615-2-125



Slotted/Pozidriv Screwdriver Set with Rubber Grip - 6 Pcs



610-6



6



1 610-6

611-5.5-100, 611-6.5-125



613-3-75, 613-4-100



616-1-100, 616-2-125



Slotted/Phillips/Robertson Screwdriver Set with Rubber Grip - 10 Pcs



605-10-PC-AU



10



1 605-10-PC-AU

Robertson R1x100; R2x100; Stubby PZ2 X 25

611-5.5-100, 611-6.5-125, 611-8-150

613-3-75

615-1-100, 615-2-125, 615-3-150

616-2-25, 619-1-100, 619-2-100

Slotted Flat Screwdrivers with Rubber Grip 3.5-10 mm



611



3.5 mm	75 mm	25 mm	80 mm	10	611-3.5-75
3.5 mm	100 mm	25 mm	80 mm	10	611-3.5-100
4.0 mm	75 mm	25 mm	80 mm	10	611-4-75
4.0 mm	100 mm	25 mm	80 mm	10	611-4-100
5.5 mm	100 mm	30 mm	97 mm	10	611-5.5-100
5.5 mm	125 mm	30 mm	97 mm	10	611-5.5-125
6.5 mm	25 mm	35 mm	60 mm	10	611-6.5-25
6.5 mm	125 mm	35 mm	110 mm	10	611-6.5-125
6.5 mm	150 mm	35 mm	110 mm	10	611-6.5-150
8.0 mm	150 mm	35 mm	110 mm	10	611-8-150
8.0 mm	175 mm	35 mm	110 mm	10	611-8-175
10.0 mm	200 mm	35 mm	110 mm	10	611-10-200

Slotted Straight Screwdrivers with Rubber Grip 3.0 -6.5 mm



613



3.0 mm	75 mm	25 mm	80 mm	10	613-3-75
3.0 mm	100 mm	25 mm	80 mm	10	613-3-100
3.5 mm	100 mm	25 mm	80 mm	10	613-3.5-100
4.0 mm	100 mm	25 mm	80 mm	10	613-4-100
4.0 mm	125 mm	25 mm	80 mm	10	613-4-125
5.5 mm	150 mm	30 mm	97 mm	10	613-5.5-150
6.5 mm	150 mm	35 mm	110 mm	10	613-6.5-150

Phillips Screwdrivers with Rubbered Grip PH0-PH3



615



PH 0	75 mm	25 mm	80 mm	10	615-0-75
PH 1	100 mm	30 mm	97 mm	10	615-1-100
PH 2	25 mm	35 mm	60 mm	10	615-2-25
PH 2	125 mm	35 mm	110 mm	10	615-2-125
PH 3	150 mm	35 mm	110 mm	10	615-3-150

Pozidriv Screwdrivers with Rubbered Grip PZ0-PZ3



616

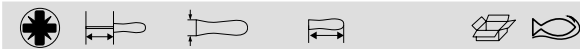

PZ 0	75 mm	25 mm	80 mm	10	616-0-75
PZ 1	100 mm	30 mm	97 mm	10	616-1-100
PZ 2	125 mm	35 mm	110 mm	10	616-2-125
PZ 3	150 mm	35 mm	110 mm	10	616-3-150

TORX® Screwdrivers with Rubber Grip T10-T40



618

T 10		75 mm	25 mm	80 mm	10	618-10-75
T 15		100 mm	25 mm	80 mm	10	618-15-100
T 20		100 mm	25 mm	80 mm	10	618-20-100
T 25		125 mm	30 mm	97 mm	10	618-25-125
T 27		125 mm	30 mm	97 mm	10	618-27-125
T 30		150 mm	35 mm	110 mm	10	618-30-150
T 40		150 mm	35 mm	110 mm	10	618-40-150

SCREWDRIVERS WITH RATCHETING GRIP

1/4" Bit Holder Ratcheting Screwdrivers



808050

1/4"		125 mm	41.6 mm	123 mm	25	808050

1/4" Heavy-Duty Bit Set for Nut Drivers & Slotted/Phillips/Pozidriv/Torx®/Hex Bits with Ratcheting Screwdriver Holder - 36 pcs



59/S36BCR

36	43 x 135 x 215 mm	6	59/S36BCR

Phillips/Pozidriv/Slotted LED Light Ratcheting Screwdriver with Ratcheting Grip



808050L

1/4 in	10x35 mm	808050L	25	808050L
			50	808050L-SP1

1/4" Ratcheting Bit Screwdriver with Pistol Handle



808050P

1/4 in	135 mm	40 mm	125 mm	25	808050P







SCREWDRIVERS WITH PRECISION GRIP

Slotted/Phillips Screwdriver Set with Precision Grip 1.5-3.0mm/PH0-PH1 - 6 Pcs



706-1  

 X	 
6	1 706-1





- 700-2-50, 700-2.5-50, 700-1.5-50, 700-3-50  
- 701-0-50, 701-1-75  

Slotted/Phillips Screwdriver Set with Precision Grip 1.0-1.8 mm/PH0-PH0 - 6 Pcs



706-2  

 X	 
6	1 706-2



- 700-1.5-50, 700-1.2-50, 700-1-50, 700-1.8-50  
- 701-00-50, 701-0-50  

Slotted Screwdriver Set with Precision Grip 1.0 - 2.5 mm - 6 Pcs



706-3 

 X	 
6	1 706-3







- 700-2.5-50, 700-2-50, 700-1.8-50, 700-1.5-50, 700-1.2-50, 700-1-50  

Slotted/Phillips/TORX® Screwdriver Set with Precision Grip - 7 Pcs



706-4  

 X	 
7	1 706-4

- 700-2.5-50, 700-3.5-75, 700-1.5-50  
- 701-1-75, 701-0-50  
- 703-8-50, 703-6-50  



Slotted/Phillips/Pozidriv/TORX/Hex Screwdriver Set with Precision Grip - 24 Pcs



706-5

24	1	706-5

700-3-50, 700-2-50, 700-3.5-75, 700-4-75, 700-1.5-50, 700-1.2-50, 700-1-50, 700-1.8-50	
701-00-50, 701-0-50, 701-1-75	
702-1-75, 702-0-50	
703-6-50, 703-9-50, 703-10-50, 703-7-50, 703-8-50, 703-15-75, 703-20-75	
704-2.5-50, 704-3-75, 704-1.5-50, 704-2-50	

Slotted Screwdrivers with Precision Grip 1.0-4.0 mm



700

Tip Size	Length	Shaft Dia	Tip Dia	Part No.
1 mm	50 mm	14 mm	87 mm	5 700-1-50
1.2 mm	50 mm	14 mm	87 mm	5 700-1.2-50
1.5 mm	50 mm	14 mm	87 mm	5 700-1.5-50
1.8 mm	50 mm	14 mm	87 mm	5 700-1.8-50
2 mm	50 mm	14 mm	87 mm	5 700-2-50
2.5 mm	50 mm	14 mm	87 mm	5 700-2.5-50
3 mm	50 mm	14 mm	87 mm	5 700-3-50
3 mm	100 mm	14 mm	87 mm	5 700-3-100
3 mm	200 mm	14 mm	87 mm	5 700-3-200
3.5 mm	75 mm	14 mm	87 mm	5 700-3.5-75
4 mm	75 mm	14 mm	87 mm	5 700-4-75
4 mm	250 mm	14 mm	87 mm	5 700-4-250

Phillips Screwdrivers with Precision Grip PH00-PH1



701

Tip Size	Length	Shaft Dia	Tip Dia	Part No.
PH 00	50 mm	14 mm	87 mm	5 701-00-50
PH 0	50 mm	14 mm	87 mm	5 701-0-50
PH 0	200 mm	14 mm	87 mm	5 701-0-200
PH 1	75 mm	14 mm	87 mm	5 701-1-75
PH 1	250 mm	14 mm	87 mm	5 701-1-250

Pozidriv Screwdrivers with Precision Grip PZ0-PZ1



702

Tip Size	Length	Shaft Dia	Tip Dia	Part No.
PZ 0	50 mm	14 mm	87 mm	5 702-0-50
PZ 1	75 mm	14 mm	87 mm	5 702-1-75

TORX® Screwdrivers with Precision Grip T4-T20



703

Tip Size	Length	Shaft Dia	Tip Dia	Part No.
T 4	50 mm	14 mm	87 mm	5 703-4-50
T 5	50 mm	14 mm	87 mm	5 703-5-50
T 6	50 mm	14 mm	87 mm	5 703-6-50
T 7	50 mm	14 mm	87 mm	5 703-7-50
T 8	50 mm	14 mm	87 mm	5 703-8-50
T 9	50 mm	14 mm	87 mm	5 703-9-50
T 10	50 mm	14 mm	87 mm	5 703-10-50
T 15	75 mm	14 mm	87 mm	5 703-15-75
T 20	75 mm	14 mm	87 mm	5 703-20-75

Hex Ball Screwdrivers with Precision Grip 1.5-3 mm 3/32"



704



Tip Size	Length	Blade Length	Blade Width	Blade Thickness	Blade Shape	Blade Material
1.5	50 mm	14 mm	87 mm	5	704-1.5-50	
2	50 mm	14 mm	87 mm	5	704-2-50	
2.5	50 mm	14 mm	87 mm	5	704-2.5-50	
3	75 mm	14 mm	87 mm	5	704-3-75	
3/32	75 mm	14 mm	87 mm	5	704Z-3/32	

Watchmakers Slotted Screwdrivers with Precision Grip and 4 Interchangeable Blades



510034



Tip Size	Length	Blade Length	Blade Width	Blade Thickness	Blade Shape	Blade Material
0.25x1.5, 0.3x2, 0.4x2.5, 0.5x3	8.5 mm	10	510034			

0.25x1.5; 0.3x2.0; 0.4x2.5; 0.5x3.0mm

Watchmakers Slotted Screwdrivers with Precision Grip 2.5-4.5 mm



2784



Tip Size	Length	Blade Length	Blade Width	Blade Thickness	Blade Shape	Blade Material
2.5 mm	6 mm	100 mm	1	2784-2.5		
3.5 mm	6 mm	104 mm	1	2784-3.5		
4.5 mm	10 mm	110 mm	1	2784-4.5		

Watchmakers Slotted Screwdriver Set with Precision Grip 0.6-2.5 mm - 5 Pcs



98505



Tip Size	Length	Blade Length	Blade Width	Blade Thickness	Blade Shape	Blade Material
5			5	98505*		

Watchmakers Slotted Screwdriver Set with Precision Grip 1.0-3.5 mm - 6 Pcs



510031



Tip Size	Length	Blade Length	Blade Width	Blade Thickness	Blade Shape	Blade Material
6			5	510031		

Watchmakers Phillips Screwdriver Set with Precision Grip PH000-PH0 - 3 Pcs



510033

Tip Size	Length	Blade Length	Blade Width	Blade Thickness	Blade Shape	Blade Material
3			5	510033		

PH000; PH00; PH0

* Until stocks last



SCREWDRIVERS WITH T-HANDLE GRIP

Hex Screwdriver Set with T-Handle Grip - 6 Pcs



903T-1



6

1 903T-1

900T-030-100, 900T-040-150, 900T-050-150, 900T-060-200, 900T-080-200, 900T-100-200

TORX® Screwdriver Set with T-Handle Grip - 6 Pcs



903T-2



6

1 903T-2

901T-015-150, 901T-020-150, 901T-010-100, 901T-030-200, 901T-040-200, 901T-025-150

BAHCO®

Hex Nut Driver Set with T-Handle Grip - 6 Pcs



903T-3



6

1 903T-3

902T-060-150, 902T-070-175, 902T-050-150, 902T-080-175, 902T-100-175, 902T-130-175

Hex Screwdrivers with T-Handle Grip



900T

2 mm	100 mm	50 mm	85 mm	5	900T-020-100	
2.5 mm	100 mm	50 mm	85 mm	5	900T-025-100	
3 mm	100 mm	50 mm	85 mm	5	900T-030-100	
4 mm	138 mm	50 mm	85 mm	5	900T-040-150	
5 mm	138 mm	60 mm	105 mm	5	900T-050-150	
6 mm	185 mm	60 mm	105 mm	5	900T-060-200	
8 mm	185 mm	60 mm	105 mm	5	900T-080-200	
10 mm	185 mm	60 mm	105 mm	5	900T-100-200	

TORX® Screwdrivers with T-Handle Grip



901T

T 6	100 mm	50 mm	85 mm	5	901T-006-100	
T 7	100 mm	50 mm	85 mm	5	901T-007-100	
T 8	100 mm	50 mm	85 mm	5	901T-008-100	
T 9	100 mm	50 mm	85 mm	5	901T-009-100	
T 10	100 mm	50 mm	85 mm	5	901T-010-100	
T 15	138 mm	50 mm	85 mm	5	901T-015-150	
T 20	138 mm	50 mm	85 mm	5	901T-020-150	
T 25	138 mm	60 mm	105 mm	5	901T-025-150	
T 27	138 mm	60 mm	105 mm	5	901T-027-150	
T 30	185 mm	60 mm	105 mm	5	901T-030-200	



T 40	185 mm	60 mm	105 mm	5	901T-040-200
T 45	185 mm	60 mm	105 mm	5	901T-045-200
T 50	185 mm	60 mm	105 mm	5	901T-050-200

Hex Head Nut Drivers with T-Handle Grip 5-13 mm



902T



5 mm	136 mm	50 mm	85 mm	5	902T-050-150
5.5 mm	136 mm	50 mm	85 mm	5	902T-055-150
6 mm	136 mm	50 mm	85 mm	5	902T-060-150
7 mm	160 mm	60 mm	105 mm	5	902T-070-175
8 mm	160 mm	60 mm	105 mm	5	902T-080-175
9 mm	160 mm	60 mm	105 mm	5	902T-090-175
10 mm	160 mm	60 mm	105 mm	5	902T-100-175
11 mm	160 mm	60 mm	105 mm	5	902T-110-175
12 mm	160 mm	60 mm	105 mm	5	902T-120-175
13 mm	160 mm	60 mm	105 mm	5	902T-130-175

Socket Drivers with T-Handle Grip 1/4"



905T



1/4"	45 mm	60 mm	105 mm	5	905T-060-100
------	-------	-------	--------	---	--------------

SCREWDRIVERS WITH 1/4" BIT HOLDERS

1/4" x 125 mm Magnetic Bit Holders



B705



1/4" in	125 mm	30 mm	105 mm	5	B705.1/4.125
1/4" in	125 mm	30 mm	105 mm	1	SB705.1/4.125

1/4" Hex Head T-Handle Bit Holders



904T



1/4 in	150 mm	5	904T-060-150
--------	--------	---	--------------

1/4" Bit Holder Screwdrivers for Phillips/Pozidriv/Slotted/TORX® Head Screw



808050A/TORX



1/4 in	115 mm	40 mm	115 mm	25	808050A
1/4 in	115 mm	40 mm	115 mm	25	808050TORX

SCREWDRIVERS WITH WOODEN OR PLASTIC GRIP

Slotted Flat Screwdrivers with Wooden Handle 3.5-10 mm



9710



3.5 mm	75 mm	22 mm	95 mm	10	9710-3.5-75
5.5 mm	100 mm	24 mm	100 mm	10	9710-5.5-100
6.5 mm	125 mm	27 mm	110 mm	10	9710-6.5-125
8.0 mm	150 mm	30 mm	120 mm	5	9710-8-150
10.0 mm	175 mm	32 mm	125 mm	5	9710-10-175



Phillips Screwdrivers with Wooden Handle PH1-PH3



9778

PH 1		80 mm	24 mm	100 mm	10	9778-1
PH 2		110 mm	27 mm	110 mm	10	9778-2
PH 3		150 mm	30 mm	120 mm	5	9778-3

Slotted and Phillips Reversible Blade Screwdrivers



1019/1067

4,5 mm		PH 1	10	1067
6 mm		PH 2	10	1019

Pozidriv Screwdrivers with Wooden Handle PZ1-PZ2



9778PZD

PZ 1		80 mm	24 mm	100 mm	10	9778PZD-1
PZ 2		110 mm	27 mm	110 mm	10	9778PZD-2

Slotted/Phillips Reversible blade Screwdriver with Plastic Handle 6.0 mm/PH2



8052

PH 2		80 mm	28 mm	110 mm	5	8052

Slotted/Phillips Screwdriver Set with Wooden Handle - 6 Pcs



9710/S6

6		1	9710/S6

0,8x4,5x90

9710-4.5-90		
9710-5.5-100, 9710-6.5-125, 9710-8-150		
9778-1, 9778-2		

Stubby Slotted and Phillips Reversible Blade Screwdrivers



1016

6 mm		PH 2	10	1016

Reversible Blade Phillips/Slotted Screwdriver Set



6

PH 0, PH 1, PH 2	3,5-5,0-6,5 mm	1	6

Slotted Straight Tipped Screwdrivers with Impact Grip 2.5 x 250 mm



9715

14.0 mm	250 mm	32 mm	140 mm	5 9715-14-250

Precision Slotted Screwdrivers with Plastic Handle 2.0-3.0 mm



7372I

2.0 mm	63 mm	13 mm	80 mm	10 7372I-2-63
2.5 mm	75 mm	13 mm	80 mm	10 7372I-2.5-75
3.0 mm	80 mm	13 mm	80 mm	10 7372I-3-80

ELECTRICAL TESTERS

150-250 V Voltage Testers with neon indicator



806

3.0 mm	65 mm	16 mm	75 mm	6 806-1-1
3.5 mm	100 mm	17.5 mm	90 mm	6 806-1-2

6-24V Auto Tester with neon light



806-1-3

3 mm	45 mm	16 mm	75 mm	6 806-1-3

150-250 V Voltage Tester, 3.5 mm, 77 mm blade with neon indicator



8045VDE

3.5 mm	77 mm	14 mm	92 mm	10 8045VDE



150-250 V Voltage Tester, 3.5 mm, 42 mm blade with neon indicator



8045LVDE



3.5 mm 42 mm 16 mm 90 mm 10 8045LVDE

ACCESSORIES

Magnetising and Demagnetising Boxes for Screwdriver Blades/
Tweezers



M780

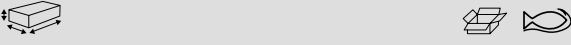

29 x 52 x 50 mm 1 M780

Magnetizer and Demagnetizer for Screwdriver Blades/Tweezers/
Scissors



M781

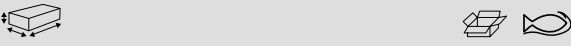

22 x 125 x 40 mm 5 M781



L-Keys



HEXAGONAL TIPPED

Metric Hex L-Keys with Nickel Finish



1998M

Hex Size	Length (L)	Quantity	Part No.
1.5 mm	47 mm	10	1998M-1.5
2 mm	52 mm	10	1998M-2
2.5 mm	59 mm	10	1998M-2.5
3.0 mm	66 mm	10	1998M-3
4.0 mm	74 mm	10	1998M-4
5.0 mm	85 mm	10	1998M-5
6.0 mm	96 mm	10	1998M-6
7.0 mm	102 mm	10	1998M-7
8.0 mm	108 mm	10	1998M-8
9.0 mm	114 mm	5	1998M-9
10 mm	122 mm	10	1998M-10
12.0 mm	137 mm	5	1998M-12
14.0 mm	154 mm	1	1998M-14
17.0 mm	177 mm	1	1998M-17
19.0 mm	199 mm	1	1998M-19
22.0 mm	222 mm	1	1998M-22

Metric Hex L-Key Set with Nickel Finish - 6 Pcs



1998M/

Hex Size	Quantity	Part No.
2, 2.5, 3, 4, 5, 6 mm	6	1998M/6T

1998M-4, 1998M-5, 1998M-6, 1998M-2.5, 1998M-2, 1998M-3

Metric Hex L-Key Set with Nickel Finish - 8 Pcs



1998M/8T

Hex Size	Quantity	Part No.
2, 2.5, 3, 4, 5, 6, 7, 8 mm	8	1998M/8T

1998M-3, 1998M-2, 1998M-6, 1998M-7, 1998M-4, 1998M-5, 1998M-8, 1998M-2.5

Metric Hex L-Key Set with Nickel Finish - 10 Pcs



1998M/10T

Hex Size	Quantity	Part No.
2, 2.5, 3, 4, 5, 6, 7, 8, 9, 10 mm	10	1998M/10T

1998M-5, 1998M-4, 1998M-7, 1998M-6, 1998M-2, 1998M-3, 1998M-2.5, 1998M-8, 1998M-9, 1998M-10

Metric Hex L-Key Set with Nickel Finish - 11 Pcs



1998M/11T

Hex Size	Quantity	Part No.
2, 2.5, 3, 4, 5, 6, 7, 8, 9, 10, 12 mm	11	1998M/11T

1998M-5, 1998M-4, 1998M-7, 1998M-6, 1998M-2, 1998M-3, 1998M-2.5, 1998M-8, 1998M-9, 1998M-10, 1998M-12

Metric Hex L-Key Set with Nickel Finish - 15 Pcs



1998M/15T

Hex Size	Quantity	Part No.
2, 2.5, 3, 4, 5, 6, 7, 8, 9, 10, 12, 14, 17, 19, 22 mm	15	1998M/15T

1998M-2, 1998M-5, 1998M-4, 1998M-7, 1998M-6, 1998M-3, 1998M-2.5, 1998M-14, 1998M-17, 1998M-19, 1998M-22, 1998M-8, 1998M-9, 1998M-10, 1998M-12

Metric Hex L-Key Set with Nickel Finish and Two-Component Compact Holder - 9 Pcs



BE-9878

Hex Size	Quantity	Part No.
1.5, 2, 2.5, 3, 4, 5, 6, 8, 10 mm	9	BE-9878

1998M-1.5, 1998M-2.5, 1998M-2, 1998M-3, 1998M-4, 1998M-5, 1998M-6, 1998M-8, 1998M-10

Metric Hex Folding L-Key Set with Zinc Finish - 7 Pcs



1999M/7H

Hex Size	Quantity	Part No.
2.5 3 4 5 6 8 10 mm	7	1999M/7H*

2.5, 3, 4, 5, 6, 8, 10

Imperial Long Ball End Hex L-Key Set with Nickel Finish - 12 Pcs



BE-9880

Hex Size	Quantity	Part No.
0.050; 1/16; 5/64; 3/32; 7/64; 1/8; 9/64; 5/32; 3/16; 7/32; 1/4; 5/16 in	12	BE-9880

Metric Hex L-Keys with Phosphate Finish



1995M

Hex Size	Length (L)	Quantity	Part No.
0.9 mm	33 mm	10	1995M-0.9
1.5 mm	47 mm	10	1995M-1.5
2.0 mm	52 mm	10	1995M-2
2.5 mm	59 mm	10	1995M-2.5
3.0 mm	66 mm	10	1995M-3
4.0 mm	74 mm	10	1995M-4
5.0 mm	85 mm	10	1995M-5
6.0 mm	96 mm	10	1995M-6
7.0 mm	102 mm	10	1995M-7
8.0 mm	108 mm	10	1995M-8
9.0 mm	114 mm	10	1995M-9
10 mm	122 mm	10	1995M-10
12 mm	137 mm	10	1995M-12
14 mm	154 mm	10	1995M-14
17 mm	177 mm	10	1995M-17
19 mm	199 mm	10	1995M-19
22 mm	222 mm	10	1995M-22

Imperial Hex L-Keys with Phosphate Finish



1995Z

Hex Size	Length (L)	Quantity	Part No.
1/16 in	47 mm	10	1995Z-1/16
5/64 in	52 mm	10	1995Z-5/64
3/32 in	59 mm	10	1995Z-3/32
1/8 in	66 mm	10	1995Z-1/8
5/32 in	74 mm	10	1995Z-5/32
3/16 in	85 mm	10	1995Z-3/16
7/32 in	91 mm	10	1995Z-7/32
1/4 in	96 mm	10	1995Z-1/4
5/16 in	108 mm	10	1995Z-5/16
3/8 in	122 mm	10	1995Z-3/8
7/16 in	129 mm	10	1995Z-7/16
1/2 in	145 mm	10	1995Z-1/2
5/8 in	168 mm	10	1995Z-5/8
3/4 in	199 mm	10	1995Z-3/4

Metric Hex L-Key Set with Phosphate Finish - 6 Pcs



1995M/

Hex Size	Quantity	Part No.
2, 2.5, 3, 4.5, 6 mm	6	1995M/6T

1995M-2, 1995M-2.5, 1995M-3, 1995M-4, 1995M-5, 1995M-6

Metric Hex L-Key Set with Phosphate Finish - 8 Pcs



1995M/8T

Hex Size	Quantity	Part No.
2, 2.5, 3, 4, 5, 6, 7, 8 mm	8	1995M/8T

1995M-2, 1995M-2.5, 1995M-3, 1995M-4, 1995M-5, 1995M-6, 1995M-7, 1995M-8

Metric Hex L-Key Set with Phosphate Finish - 10 Pcs



1995M/10T

Hex Size	Quantity	Part No.
2, 2.5, 3, 4, 5, 6, 7, 8, 9, 10 mm	10	1995M/10T

1995M-2.5, 1995M-2, 1995M-6, 1995M-5, 1995M-4, 1995M-3, 1995M-9, 1995M-10, 1995M-7, 1995M-8

Metric Hex L-Key Set with Phosphate Finish - 11 Pcs



1995M/11T

Hex Size	Quantity	Part No.
2, 2.5, 3, 4, 5, 6, 7, 8, 9, 10, 12 mm	11	1995M/11T

1995M-2, 1995M-6, 1995M-5, 1995M-4, 1995M-2.5, 1995M-3, 1995M-9, 1995M-10, 1995M-7, 1995M-8, 1995M-12

Metric Hex L-Key Set with Phosphate Finish - 15 Pcs



1995M/15T

Hex Size	Quantity	Part No.
2, 2.5, 3, 4, 5, 6, 7, 8, 9, 10, 12, 14, 17, 19, 22 mm	15	1995M/15T

1995M-2, 1995M-2.5, 1995M-3, 1995M-4, 1995M-5, 1995M-6, 1995M-7, 1995M-8, 1995M-9, 1995M-10, 1995M-12, 1995M-14, 1995M-17, 1995M-19, 1995M-22

Metric Hex L-Key Set with Phosphate Finish and Two-Component Holder - 9 Pcs



BE-9578

Hex Size	Quantity	Part No.
1.5, 2, 2.5, 3, 4, 5, 6, 8, 10 mm	9	BE-9578

1995M-2.5, 1995M-2, 1995M-1.5, 1995M-6, 1995M-5, 1995M-4, 1995M-3, 1995M-8, 1995M-10

* Until stocks last



Metric Hex Folding L-Key Set with Two-Component Handle 2.5 mm -10 mm - 7 Pcs



BE-9777B

2.5 3 4 5 6 8 10 mm	7	6	BE-9777B

2.5, 3, 4, 5, 6, 8, 10 mm

Metric Hex Folding L-Key Set 1.5 mm-6 mm - 7 Pcs



BE-9776

1.5 2 2.5 3 4 5 6 mm	6	6	BE-9776

1.5, 2, 2.5, 3, 4, 5, 6 mm

Metric Hex Folding L-Key Set 2.5 mm-10 mm - 7 Pcs



BE-9777

2.5 3 4 5 6 8 10 mm	7	6	BE-9777

2.5, 3, 4, 5, 6, 8, 10 mm

Imperial Hex L-Key Set with Phosphate Finish - 10 Pcs



1995Z/10T

1/16, 5/64, 3/32, 1/8, 5/32, 3/16, 7/32, 1/4, 5/16, 3/8 in	10	1	1995Z/10T

1995Z-1/16, 1995Z-5/64, 1995Z-3/32, 1995Z-1/8, 1995Z-5/32, 1995Z-3/16, 1995Z-3/8, 1995Z-7/32, 1995Z-1/4, 1995Z-5/16

Imperial Hex L-Key Set with Phosphate Finish - 12 Pcs



1995Z/12T

1/16, 5/64, 3/32, 1/8, 5/32, 3/16, 7/32, 1/4, 5/16, 3/8, 7/16, 1/2 in	12	1	1995Z/12T

1995Z-1/16, 1995Z-5/64, 1995Z-3/32, 1995Z-1/8, 1995Z-5/32, 1995Z-3/16, 1995Z-1/2, 1995Z-7/16, 1995Z-3/8, 1995Z-7/32, 1995Z-1/4, 1995Z-5/16

Imperial Hex Folding L-Key Set 3/32" - 3/8" - 7 Pcs



BE-9787

3/32 1/8 5/32 3/16 1/4 5/16 3/8 in	7	6	BE-9787

Metric Long Hex L-Keys with Phosphate Finish



1995LM

1.5 mm	91 mm	10	1995LM-1.5
2 mm	102 mm	10	1995LM-2
2.5 mm	114 mm	10	1995LM-2,5
3.0 mm	129 mm	10	1995LM-3
4.0 mm	144 mm	10	1995LM-4
5.0 mm	165 mm	10	1995LM-5
6.0 mm	186 mm	10	1995LM-6
7.0 mm	197 mm	10	1995LM-7
8.0 mm	208 mm	10	1995LM-8
9.0 mm	219 mm	10	1995LM-9
10 mm	234 mm	10	1995LM-10
12 mm	262 mm	10	1995LM-12
14 mm	294 mm	10	1995LM-14

Metric Long Hex L-Key Set with Phosphate Finish and Two-Component Holder - 6 Pcs



BE-9586

1.5, 2, 2.5, 3, 4, 5 mm	6	1	BE-9586

1995LM-1.5, 1995LM-3, 1995LM-2.5, 1995LM-2, 1995LM-4, 1995LM-5

Metric Long Hex L-Key Set with Phosphate Finish and Two-Component Holder - 9 Pcs



BE-9588

1.5, 2, 2.5, 3, 4, 5, 6, 8, 10 mm	9	1	BE-9588

1995LM-1.5, 1995LM-2, 1995LM-2.5, 1995LM-3, 1995LM-4, 1995LM-5, 1995LM-6, 1995LM-8, 1995LM-10

Metric Long Ball End Hex L-Keys with Phosphate Finish



1996M

Size	Length	Qty	Part No.
1.5 mm	91 mm	10	1996M-1.5
2.0 mm	102 mm	10	1996M-2
2.5 mm	114 mm	10	1996M-2.5
3.0 mm	129 mm	10	1996M-3
4.0 mm	144 mm	10	1996M-4
5.0 mm	165 mm	10	1996M-5
6.0 mm	186 mm	10	1996M-6
8.0 mm	208 mm	10	1996M-8
10 mm	234 mm	10	1996M-10
12 mm	262 mm	5	1996M-12

Metric Long Ball End Coloured Hex L-Key Set - 9 Pcs



C1997LM/9P

Size	Qty	Part No.
1.5, 2, 2.5, 3, 4, 5, 6, 8, 10 mm	9	1 C1997LM/9P

Metric Long Ball End Hex L-Key Set with Phosphate Finish - 6 Pcs



BE-9765

Size	Qty	Part No.
1.5, 2, 2.5, 3, 4, 5 mm	6	3 BE-9765

1996M-1.5, 1996M-2.5, 1996M-2, 1996M-4, 1996M-3, 1996M-5

Metric Long Ball End Hex L-Key Set with Phosphate Finish - 9 Pcs



BE-9770

Size	Qty	Part No.
1.5, 2, 2.5, 3, 4, 5, 6, 8, 10 mm	9	3 BE-9770

Metric Long Ball End Hex L-Key Set with Phosphate Finish and Two-Component Holder - 9 Pcs



BE-9676

Size	Qty	Part No.
1.5, 2, 2.5, 3, 4, 5 mm	6	1 BE-9676

1996M-1.5, 1996M-2, 1996M-2.5, 1996M-3, 1996M-4, 1996M-5

Metric Long Ball End Hex L-Key Set with Phosphate Finish and Two-Component Holder - 9 Pcs



BE-9678

Size	Qty	Part No.
1.5, 2, 2.5, 3, 4, 5, 6, 8, 10 mm	9	1 BE-9678

1996M-4, 1996M-5, 1996M-2.5, 1996M-3, 1996M-10, 1996M-6, 1996M-8, 1996M-2, 1996M-1.5

Metric Long Ball End Hex L-Key Set with Phosphate Finish and Two-Component Magnetiser Holder - 9 Pcs



BE-9688

Size	Qty	Part No.
1.5, 2, 2.5, 3, 4, 5, 6, 8, 10 mm	9	1 BE-9688

1996M-1.5, 1996M-2, 1996M-2.5, 1996M-3, 1996M-4, 1996M-5, 1996M-6, 1996M-8, 1996M-10

Metric Ball End Hex Folding L-Key Set with Two-Component Handle 2.5 mm - 10 mm - 7 Pcs



BE-9776B

Size	Qty	Part No.
2.5, 3, 4, 5, 6, 8, 10 mm	7	6 BE-9776B

Imperial Long Ball End Hex L-Key Set with Phosphate Finish - 7 Pcs



BE-9775

Size	Qty	Part No.
1/16, 5/64, 3/32, 1/8, 5/32, 3/16, 1/4 in	7	3 BE-9775

5/64 3/32 1/4 1/8 1/16 5/32 3/16



Imperial Long Ball End Hex L-Key Set with Phosphate Finish - 12 Pcs



BE-9780

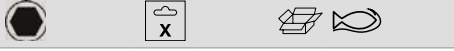

0.05 1/16 5/64 3/32 7/64 1/8 9/64 5/32 3/16 7/32 1/4 5/16 in 12 3 BE-9780

0.05 1/16 5/64 3/32 7/64 1/8 9/64 5/32 3/16 7/32 1/4 5/16

Imperial Long Ball End Hex L-Key Set with Phosphate Finish - 13 Pcs



BE-9785

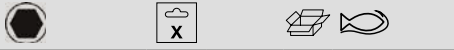

0.05 1/16 5/64 3/32 7/64 1/8 9/64 5/32 3/16 7/32 1/4 5/16 3/8 in 13 3 BE-9785

0.05 1/16 5/64 3/32 7/64 1/8 9/64 5/32 3/16 7/32 1/4 5/16 3/8

TORX® TIPPED

Long TORX® L-Keys with Black Oxide Finish



1995TORX



T 6	75 mm	5	1995TORX-T6
T 7	80 mm	5	1995TORX-T7
T 8	80 mm	5	1995TORX-T8
T 9	80 mm	5	1995TORX-T9
T 10	86 mm	5	1995TORX-T10
T 15	90 mm	5	1995TORX-T15
T 20	95 mm	5	1995TORX-T20
T 25	100 mm	5	1995TORX-T25
T 27	105 mm	5	1995TORX-T27
T 30	114 mm	5	1995TORX-T30
T 40	124 mm	5	1995TORX-T40
T 45	133 mm	5	1995TORX-T45
T 50	152 mm	5	1995TORX-T50
T 55	184 mm	5	1995TORX-T55
T 60	204 mm	5	1995TORX-T60

Long TORX® Coloured L-Key Set - 9 Pcs



C1997TORX/9P

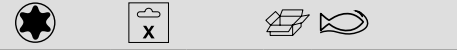

8, 9, 10, 15, 20, 25, 27, 30, 40 9 1 C1997TORX/9P

Long TORX® L-Key Set with Black Oxide Finish - 4 Pcs



1995TORX/

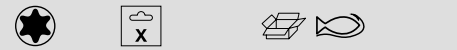

10, 20, 30, 40 4 1 1995TORX/4T

1995TORX-T40, 1995TORX-T30, 1995TORX-T10, 1995TORX-T20

Long TORX® L-Key Set with Black Oxide Finish - 7 Pcs



1995TORX/7T



10, 15, 20, 25, 27, 30, 40 7 1 1995TORX/7T

1995TORX-T20, 1995TORX-T10, 1995TORX-T15, 1995TORX-T27, 1995TORX-T25, 1995TORX-T30, 1995TORX-T40

Long TORX® L-Key Set with Black Oxide Finish - 11 Pcs



1995TORX/11T

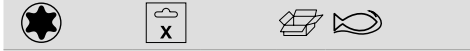

7, 9, 10, 15, 20, 25, 27, 30, 40, 45, 50 11 1 1995TORX/11T

1995TORX-T7, 1995TORX-T9, 1995TORX-T10, 1995TORX-T15, 1995TORX-T20, 1995TORX-T25, 1995TORX-T27, 1995TORX-T30, 1995TORX-T40, 1995TORX-T45, 1995TORX-T50

Long TORX® L-Key Set with Black Oxide Finish - 13 Pcs



1995TORX/13T

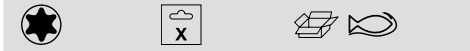

6, 7, 8, 9, 10, 15, 20, 25, 27, 30, 40, 45, 50 13 1 1995TORX/13T

1995TORX-T6, 1995TORX-T7, 1995TORX-T8, 1995TORX-T9, 1995TORX-T10, 1995TORX-T15, 1995TORX-T20, 1995TORX-T25, 1995TORX-T27, 1995TORX-T30, 1995TORX-T45, 1995TORX-T40, 1995TORX-T50

Long TORX® L-Key Set with Black Oxide Finish - 8 Pcs



BE-9575



T9, T10, T15, T20, T25, T27, T30, T40 8 1 BE-9575

1995TORX-T40, 1995TORX-T30, 1995TORX-T27, 1995TORX-T25, 1995TORX-T20, 1995TORX-T15, 1995TORX-T10, 1995TORX-T9

Long TORX® L-Key Set with Black Oxide Finish - 8 Pcs



BE-9585

T9, T10, T15, T20, T25, T27, T30, T40	8	1	BE-9585

1995TORX-T9, 1995TORX-T10, 1995TORX-T15, 1995TORX-T20, 1995TORX-T25, 1995TORX-T27, 1995TORX-T30, 1995TORX-T40

Folding TORX® L-Key Set with Two Component Handle T9 - T40 - 8 Pcs



BE-8975B

T9 - T10 - T15 - T20 - T25 - T27 - T30 - T40	8	6	BE-8975B

Folding TORX® L-Key Set T9 - T40 - 8 Pcs



BE-8975

T9 T10 T15 T20 T25 T27 T30 T40	8	6	BE-8975

Long Ball End TORX® L-Keys with Black Oxide Finish



1996TORX

T9	80 mm	5	1996TORX-T9
T10	86 mm	5	1996TORX-T10
T15	90 mm	5	1996TORX-T15
T20	95 mm	5	1996TORX-T20
T25	100 mm	5	1996TORX-T25
T27	105 mm	5	1996TORX-T27
T30	114 mm	5	1996TORX-T30
T40	124 mm	5	1996TORX-T40
T45	133 mm	5	1996TORX-T45
T50	152 mm	5	1996TORX-T50

Long Ball End TORX® L-Key Set with Black Oxide Finish - 5 Pcs



1996TORX/

T10, T20, T25, T30, T40	5	1	1996TORX/5T

1996TORX-T10, 1996TORX-T20, 1996TORX-T25, 1996TORX-T30, 1996TORX-T40

Long Ball End TORX® L-Key Set with Black Oxide Finish - 8 Pcs



BE-9675

T9, T10, T15, T20, T25, T27, T30, T40	8	1	BE-9675

1996TORX-T9, 1996TORX-T10, 1996TORX-T15, 1996TORX-T20, 1996TORX-T25, 1996TORX-T27, 1996TORX-T30, 1996TORX-T40

Long Tamper-Resistant TORX® L-Keys with Black Oxide Finish



1986TORX

TR 9	80 mm	5	1986TORX-T9
TR 10	86 mm	5	1986TORX-T10
TR 15	90 mm	5	1986TORX-T15
TR 20	95 mm	5	1986TORX-T20
TR 25	100 mm	5	1986TORX-T25
TR 27	105 mm	5	1986TORX-T27
TR 30	114 mm	5	1986TORX-T30
TR 40	124 mm	5	1986TORX-T40

Long Tamper-Resistant TORX® L-Key Set with Black Oxide Finish - 7 Pcs



1986TORX/

TR10, TR15, TR20, TR25, TR27, TR30, TR40	7	1	1986TORX/7T

1986TORX-T10, 1986TORX-T15, 1986TORX-T20, 1986TORX-T25, 1986TORX-T27, 1986TORX-T30, 1986TORX-T40

Long Tamper-Resistant TORX® L-Key Set with Black Oxide Finish - 8 Pcs



BE-8675

T9, T10, T15, T20, T25, T27, T30, T40	8	1	BE-8675

1986TORX-T9, 1986TORX-T10, 1986TORX-T15, 1986TORX-T20, 1986TORX-T25, 1986TORX-T27, 1986TORX-T30, 1986TORX-T40



Folding TORX® Tamper L-Key Set with Two Component Handle T9 - T40 - 8 Pcs



BE-8976B

T9, T10, T15, T20, T25, T27, T30, T40	8	6	BE-8976B

Long TORX® Plus L-Key Set with Black Oxide Finish - 8 Pcs



BE-7675

IP9, IP10, IP15, IP20, IP25, IP27, IP30, IP40	8	1	BE-7675

1976TORX-T9, 1976TORX-T10, 1976TORX-T15, 1976TORX-T20, 1976TORX-T25, 1976TORX-T27, 1976TORX-T30, 1976TORX-T40

Long TORX® Plus L-Keys with Black Oxide Finish



1976TORX

IP 6	75 mm	5	1976TORX-T6
IP 7	80 mm	5	1976TORX-T7
IP 8	80 mm	5	1976TORX-T8
IP 9	80 mm	5	1976TORX-T9
IP 10	86 mm	5	1976TORX-T10
IP 15	90 mm	5	1976TORX-T15
IP 20	95 mm	5	1976TORX-T20
IP 25	100 mm	5	1976TORX-T25
IP 27	105 mm	5	1976TORX-T27
IP 30	114 mm	5	1976TORX-T30
IP 40	124 mm	5	1976TORX-T40

Long TORX® Plus L-Key Set with Black Oxide Finish - 5 Pcs



1976TORX/

IP 10, IP 20, IP 25, IP 30, IP 40	5	1	1976TORX/5T

1976TORX-T10, 1976TORX-T20, 1976TORX-T25, 1976TORX-T40, 1976TORX-T30

Double Offset Phillips L-Keys



2047PR

PH 1 & 2	100 mm	5	2047PR-1-2
PH 3 & 4	200 mm	5	2047PR-3-4

Double Offset Pozidriv L-Keys



2047PZ

PZ1, PZ2	100 mm	5	2047PZ-1-2

DOUBLE OFFSET

Double Offset Slotted L-Keys



2047

4.0 mm	100 mm	5	2047-0.8-4
5.5 mm	125 mm	5	2047-1-5.5
8.0 mm	150 mm	5	2047-1.2-8
10.0 mm	175 mm	1	2047-1.6-10
12.0 mm	200 mm	1	2047-2-12

MULTITOOLS

Mixed Bicycle Folding Tool Set with Pouch



BKE850901N

200 x 35 x 170 mm	10	BKE850901N



Pliers



CUTTING PLIERS

ERGO™ Side Cutting Pliers with Self Opening Dual-Component Handle and Phosphate Finish



ergo



2101G

Cu	Fe*	Plasto	L		
3.5 mm	1.8 mm	1.6 mm	125 mm	5	2101G-125
3.7 mm	2.0 mm	1.8 mm	140 mm	5	2101G-140
3.8 mm	2.5 mm	2.0 mm	160 mm	5	2101G-160
4.0 mm	2.7 mm	2.3 mm	180 mm	5	2101G-180
3.5 mm	1.8 mm	1.6 mm	125 mm	5	2101G-125IP
3.7 mm	2.0 mm	1.8 mm	140 mm	5	2101G-140IP
3.8 mm	2.5 mm	2.0 mm	160 mm	5	2101G-160IP
4.0 mm	2.7 mm	2.3 mm	180 mm	5	2101G-180IP

ERGO™ Side Cutting Pliers with Dual-Component Handle and Phosphate Finish



ergo



2101G D

Cu	Fe*	Plasto	L		
3.5 mm	1.8 mm	1.6 mm	125 mm	5	2101G-125IPD
3.7 mm	2.0 mm	1.8 mm	140 mm	5	2101G-140IPD
3.8 mm	2.5 mm	2.0 mm	160 mm	5	2101G-160IPD
4.0 mm	2.7 mm	2.3 mm	180 mm	5	2101G-180IPD

ERGO™ Side Cutting Pliers with Self Opening Dual-Component Handle and Phosphate Finish for Plastic



ergo



2101PG

L	
160 mm	5 2101PG-160

PLASTIC

ERGO™ Side Cutting Pliers with Self Opening Dual-Component Handle and Nickel-Chrome Finish



ergo



2101GC

Cu	Fe*	Plasto	L		
3.5 mm	1.8 mm	1.6 mm	125 mm	5	2101GC-125IP
3.7 mm	2.0 mm	1.8 mm	140 mm	5	2101GC-140IP
3.8 mm	2.5 mm	2.0 mm	160 mm	5	2101GC-160IP
4.0 mm	2.7 mm	2.3 mm	180 mm	5	2101GC-180IP

Side Cutting Pliers with Mono Material Handles and Phosphate Finish



2101D

Cu	Fe*	Plasto	L		
3.5 mm	1.8 mm	1.6 mm	125 mm	5	2101D-125
3.7 mm	2.0 mm	1.8 mm	140 mm	5	2101D-140
3.8 mm	2.5 mm	2.0 mm	160 mm	5	2101D-160
4.0 mm	2.7 mm	2.3 mm	180 mm	5	2101D-180
3.5 mm	1.8 mm	1.6 mm	125 mm	5	2101D-125IP
3.7 mm	2.0 mm	1.8 mm	140 mm	5	2101D-140IP
3.8 mm	2.5 mm	2.0 mm	160 mm	5	2101D-160IP
4.0 mm	2.7 mm	2.3 mm	180 mm	5	2101D-180IP

ERGO™ Heavy Duty Side Cutting Pliers with Self Opening Dual-Component Handle and Phosphate Finish



ergo



21HDG

Fe*	Plasto	L		
2.3 mm	2.1 mm	140 mm	5	21HDG-140
2.7 mm	2.3 mm	160 mm	5	21HDG-160
3.3 mm	2.8 mm	180 mm	5	21HDG-180
3.3 mm	2.8 mm	200 mm	5	21HDG-200
2.3 mm	2.1 mm	140 mm	5	21HDG-140IP
2.7 mm	2.3 mm	160 mm	5	21HDG-160IP
3.3 mm	2.8 mm	180 mm	5	21HDG-180IP
3.3 mm	2.8 mm	200 mm	5	21HDG-200IP

ERGO™ 14° Side Cutting Pliers with Self Opening Dual-Component Handle and Phosphate Finish



ergo



21HDG-A

2.2 mm	2.0 mm	140 mm	5	21HDG-140A
2.5 mm	2.3 mm	160 mm	5	21HDG-160A
2.7 mm	2.5 mm	180 mm	5	21HDG-180A
3.2 mm	3.0 mm	200 mm	5	21HDG-200A

ERGO™ Heavy Duty Side Cutting Pliers with Self Opening Dual-Component Handle and Chrome Finish



ergo



21HDGC

2.2 mm	2.2 mm	140 mm	5	21HDGC-140IP
2.5 mm	2.5 mm	160 mm	5	21HDGC-160IP
2.8 mm	2.8 mm	180 mm	5	21HDGC-180IP
3.2 mm	3.0 mm	200 mm	5	21HDGC-200IP

Heavy Duty Side Cutting Pliers with Mono Material Handles and Phosphate Finish



21HDD

2.2 mm	2.2 mm	140 mm	5	21HDD-140
2.5 mm	2.5 mm	160 mm	5	21HDD-160
2.8 mm	2.8 mm	180 mm	5	21HDD-180
3.2 mm	3.0 mm	200 mm	5	21HDD-200
2.2 mm	2.2 mm	140 mm	5	21HDD-140IP
2.5 mm	2.5 mm	160 mm	5	21HDD-160IP
2.8 mm	2.8 mm	180 mm	5	21HDD-180IP
3.2 mm	3.0 mm	200 mm	5	21HDD-200IP

Power Cutters with Dual-Component Handle and Phosphate Finish



1520G

3.8 mm	210 mm	5	1520 G
3.8 mm	210 mm	5	1520 G IP

Power Cutters with PVC Coated Handles and Phosphate Finish



1520D

3.8 mm	205 mm	5	1520 D

ERGO™ Compact Side Cutting Pliers with Dual-Component Handle and Phosphate Finish



ergo



4130, 4131

0.3-1.5 mm	120 mm	3	4130
0.3-1.5 mm	120 mm	3	4131



Compact Tapered and Relieved Head Side Cutters with Orange PVC Handle



C3330R/C3340R

0,3-1,25 mm	115 mm	10	C3330R IP*
0,4-1,6 mm	130 mm	10	C3340R IP

Side Cutting Pliers with Cellulose Acetate Handles and Nickel-Chrome Finish For Steel Wire



2666NB-2676NB

2.7 mm	2.0 mm	160 mm	1	2674 NB

Side Cutting Pliers with PVC Coated Handles and Phosphate Finish



2100PD

1.8 mm	3.0 mm	150 mm	5	2100PD-150

PLASTIC

Side Cutting Pliers with Cellulose Acetate Handles and Nickel-Chrome Finish For Piano wire



2667B-2678B

3.7 mm	2.0 mm	2.0 mm	160 mm	1	2676 B
4.0 mm	2.5 mm	2.5 mm	200 mm	1	2678 B

Side Cutting Pliers with Dual-Component Handle and Polished Finish



2171G

2.5 mm	1.6 mm	1.5 mm	150 mm	5	2171G-140
2.5 mm	1.6 mm	1.5 mm	160 mm	5	2171G-160
2.5 mm	1.6 mm	1.5 mm	185 mm	5	2171G-180

Diagonal Cutters with Oval Head



2646M - 2649

0.1-0.8 mm	Flush	108 mm	1	2646 M
0.2-1.25 mm	Micro-bevel	110 mm	1	2646 R
0.2-1.25 mm	Micro-bevel	110 mm	1	2646 RK
0.1-1.0 mm	Flush	110 mm	1	2646 RA
0.3-1.6 mm	Micro-bevel	112.5 mm	1	2666
0.4-2.0 mm	Micro-bevel	125 mm	1	2649

Diagonal Cutters with Tapered Head



2646 - 2648A

Icon	Icon	Icon	Icon	Icon
0.2-1.25 mm	Micro-bevel	110 mm	1	2646
0.2-1.25 mm	Micro-bevel	110 mm	1	2646 K
0.1-1.0 mm	Ultra-flush	110 mm	1	2646 A
0.1-1.0 mm	Ultra-flush	110 mm	1	2646 AK
0.2-1.25 mm	Ultra-flush	112.5 mm	1	2666 FK
0.4-2.0 mm	Micro-bevel	125 mm	1	2648
0.3-1.6 mm	Ultra-flush	125 mm	1	2648 A

ERGO™ 20° Oblique Cutters



ergo®



4231

Icon	Icon	Icon	Icon	Icon
0.3-1.25 mm	119 mm	3	4231	

ERGO™ 45° Oblique Cutters



ergo®



4239

Icon	Icon	Icon	Icon	Icon
0.3-1.0 mm	129 mm	3	4239	

45° Oblique Cutters with PVC Coated Handles and Phosphate Finish



2145PD

Icon	Icon	Icon	Icon	Icon
3.0 mm	1.8 mm	154 mm	5	2145PD-150

PLASTIC

45° Oblique Cutters with Long Head



2787F

Icon	Icon	Icon	Icon	Icon
0.2-1.0 mm	Flush	117.5 mm	1	2787 F

45° Oblique Cutters with Relieved Long Head



2787G





Icon	Icon	Icon	Icon	Icon
0.2-0.8 mm	Flush	117.5 mm	1	2787 G



End Cutting Pliers with Bi-Material Handles and Chrome Finish







527 GC

			
2.0 mm	160 mm	3	527 GC-160
2.5 mm	200 mm	3	527 GC-200

High Leverage End Cutting/Fencing Pliers with Black Epoxy Finish







2339

			
2.2 mm	220 mm	3	2339-220
2.2 mm	220 mm	5	2339-220IP
2.5 mm	250 mm	5	2339-250IP
3.0 mm	280 mm	5	2339-280IP
4.5 mm	300 mm	6	2339-300IP

End Cutting Pliers with PVC Handles and Phosphate Finish







527D

			
2 mm	160 mm	5	527 D-160
2.5 mm	200 mm	5	527 D-200

Pincers with PVC Handles and Black Epoxy Finish







541D

			
2.0 mm	150 mm	5	541 D-150
2.0 mm	180 mm	5	541D-180
2.5 mm	200 mm	5	541 D-200
2.5 mm	225 mm	5	541D-225
2.5 mm	250 mm	5	541 D-250

High Leverage End Cutting/Fencing Pliers with PVC Coated Handles and Black Epoxy Finish







2339D

			
2.2 mm	220 mm	3	2339 D
2.2 mm	220 mm	5	2339 DIP
4.5 mm	300 mm	5	2339D-300
4.5 mm	300 mm	6	2339D-300IP

High Leverage End Cutting/Fencing Pliers with Phosphate Finish



1519D

			
2.5 mm	230 mm	3	1519 D
		1	1519-9

Compact End Cutting Pliers with Orange PVC Handle



C3230

109 mm	10	C3230IP*

90° Side Cutting Pliers with PVC Coated Handles and Phosphate Finish



2190PD

1.8 mm	3.0 mm	143 mm	5	2190PD-150

End Cutters with Synthetic Handles and Mirror Finish



2656/2656A

0.35 - 0.8 mm	Micro	115 mm	1	2656

Cable Cutting/Stripping Pliers with PVC Coated Handles for Cu and Al Cables



2233D

10 mm	50/35 mm	160 mm	5 2233 D-160
13 mm	70/50 mm	200 mm	5 2233 D-200
16 mm	95/70 mm	240 mm	5 2233 D-240
10 mm	50/35 mm	160 mm	5 2233D-160IP
13 mm	70/50 mm	200 mm	5 2233D-200IP
16 mm	95/70 mm	240 mm	5 2233D-240IP

Cable Cutters with Epoxy Painted Handles for Cu and Al Cables 30 mm



2520

550 mm	1	2520

Cable Cutters with Epoxy Painted Handles for Cu and Al Cables 42 mm



2620-80

42 mm	800 mm	1	2620-80

* Until stocks last



Cable Cutters with Epoxy Painted Handles for Cu, Al and Steel Cables



2720

12 mm	600 mm 163 mm	1 2720 1 2720-SH	

Cable Cutters with PVC Coated Handles for Multi Wire and Flexible Conductors



2800N-2801N

0-10 mm 0-15 mm	170 mm 230 mm	1 2800 N 1 2801 N	

Cable Cutters with Elastomer Handles for Solid Materials and Multi Wire Cables



2235-160

165 mm	1 2235-160	

Bolt Cutters with Comfort Grip Handles and Phosphate Finish



4559

6 mm 8 mm 10 mm 13 mm 15 mm 15 mm	5 mm 7 mm 9 mm 10 mm 12 mm 12 mm	4 mm 6 mm 8 mm 9 mm 11 mm 11 mm	330 mm 430 mm 600 mm 750 mm 900 mm 1060 mm
			1 4559-12 8 4559-18 6 4559-24 5 4559-30 3 4559-36 2 4559-42

Cable Cutters with PVC Coated Handles for Cu and Al Cables



2804-2805

16 mm 22 mm	34 mm 52 mm	250 mm 280 mm	1 2804 1 2805-280

Spare Cutting Heads for 4559 Range Bolt Cutters



4559 JC

285 g 600 g 930 g 1260 g 2180 g 3025 g		1 4559-12A JC 1 4559-18B JC 1 4559-24B JC 1 4559-30B JC 1 4559-36B JC 1 4559-42A JC

Diagonal Bolt Cutters with Phosphate Finish



4560-210

250 mm	1	4560-210

COMBINATION PLIERS

ERGO™ Combination Pliers with Self-Opening Dual-Component Handles and Phosphate Finish



2628G

1.8 mm	2.0 mm	160 mm	5	2628 G-160
2.0 mm	2.5 mm	180 mm	5	2628 G-180
2.5 mm	3.0 mm	200 mm	5	2628 G-200
1.8 mm	2.0 mm	160 mm	5	2628 G-160IP
2.0 mm	2.5 mm	180 mm	5	2628 G-180IP
2.5 mm	3.0 mm	200 mm	5	2628G-200IP

ERGO™ Combination Pliers with Self-Opening Dual-Component Handles and Chrome Finish



2628GC

2.0 mm	1.8 mm	160 mm	5	2628 GC-160IP
2.5 mm	2.0 mm	180 mm	5	2628 GC-180IP
3.0 mm	2.5 mm	200 mm	5	2628 GC-200IP

ERGO™ Reinforced Combination Pliers with Self-Opening Dual-Component Handles and Chrome Finish



2630GC

1.8 mm	2.0 mm	160 mm	5	2630GC-160IP
2.0 mm	2.5 mm	180 mm	5	2630GC-180IP
2.5 mm	3.0 mm	200 mm	5	2630GC-200IP

ERGO™ Combi-Snipe Pliers with Self-Opening Dual-Component Handles and Phosphate Finish



2629G

160 mm	2.0 mm	1.8 mm	5	2629G-160
180 mm	3.0 mm	2.5 mm	5	2629G-180
200 mm	2.5 mm	2.0 mm	5	2629G-200
160 mm	2.5 mm	2.0 mm	5	2629G-160IP
180 mm	2.0 mm	1.8 mm	5	2629G-180IP
200 mm	3.0 mm	2.5 mm	5	2629G-200IP

Combination Pliers with Monomaterial Handles and Phosphate Finish



2628D

2.0 mm	1.8 mm	160 mm	5	2628 D-160
2.5 mm	2.0 mm	180 mm	5	2628 D-180
3.0 mm	2.5 mm	200 mm	5	2628 D-200



Reinforced Combination Pliers with Monomaterial Handles and Chrome Finish



2630DC

Fe+	Plano	L		
2.0 mm	1.8 mm	160 mm	5	2630DC-160IP
2.5 mm	2.0 mm	180 mm	5	2630DC-180IP
3.0 mm	2.5 mm	200 mm	5	2630DC-200IP

Combination Pliers with Dual-Component Handles



2678G

Fe+	Plano	L		
1.7 mm	1.3 mm	160 mm	5	2678 G-160
2.0 mm	1.4 mm	180 mm	5	2678 G-180
2.5 mm	1.5 mm	205 mm	5	2678 G-200

Universal Combination Pliers with PVC Coated Handles



2640D

Cu	Fe	Fe+	L		
3.0 mm	2.7 mm	2.5 mm	160 mm	10	2640D-160
3.0 mm	2.7 mm	2.5 mm	180 mm	5	2640D-180
3.5 mm	3.0 mm	2.5 mm	200 mm	5	2640D-200

2 Position Combination Pliers with Lacquered Finish



2970 G-200

L		
200 mm	5	2970G-200

GRIPPING PLIERS

ERGO™ Long Snipe Nose Pliers with Self-Opening Dual-Component Handles and Phosphate Finish



2430G

Cu	Fe	Fe+	L		
2.5 mm	1.8 mm	1.4 mm	140 mm	5	2430 G-140
3.0 mm	1.8 mm	1.6 mm	160 mm	5	2430 G-160
3.0 mm	1.8 mm	1.6 mm	200 mm	5	2430 G-200
2.5 mm	1.8 mm	1.4 mm	140 mm	5	2430 G-140 IP
3.0 mm	1.8 mm	1.6 mm	160 mm	5	2430 G-160 IP
3.0 mm	1.8 mm	1.6 mm	200 mm	5	2430 G-200 IP

High Leverage Universal Combination Pliers with PVC Coated Handles



2688D

Fe+	Fe	Cu	L		
2.5 mm	3.0 mm	3.5 mm	250 mm	3	2688D-250

ERGO™ Long Snipe Nose Pliers with Self-Opening Dual-Component Handles and Chrome Finish



ergo



2430GC

2.5 mm	1.8 mm	1.4 mm	140 mm	5	2430 GC-140 IP
3.0 mm	1.8 mm	1.6 mm	160 mm	5	2430 GC-160 IP
3.0 mm	1.8 mm	1.6 mm	200 mm	5	2430 GC-200 IP

Long Snipe Nose Pliers with Monomaterial Handles and Phosphate Finish



2430D

2.5 mm	1.8 mm	1.4 mm	140 mm	5	2430 D-140
3.0 mm	1.8 mm	1.6 mm	160 mm	5	2430 D-160
3.0 mm	1.8 mm	1.6 mm	200 mm	5	2430 D-200
2.5 mm	1.8 mm	1.4 mm	140 mm	5	2430 D-140 IP
3.0 mm	1.8 mm	1.6 mm	160 mm	5	2430 D-160 IP
3.0 mm	1.8 mm	1.6 mm	200 mm	5	2430 D-200 IP

ERGO™ Long Snipe Nose Pliers without Cutting Edge, with Self-Opening Dual-Component Handles and Phosphate Finish



ergo



2431G

125 mm	5	2431G-125
140 mm	5	2431G-140
160 mm	5	2431G-160
180 mm	5	2431G-180
125 mm	5	2431G-125IP
140 mm	5	2431G-140IP
160 mm	5	2431G-160IP
180 mm	5	2431G-180IP

ERGO™ Compact Snipe Nose Pliers with Dual-Component Handles and Phosphate Finish



ergo



4830, 4831

135 mm	3	4830
135 mm	3	4831

Compact Snipe Nose Pliers with Orange PVC Handle



C3830/C3840

121 mm	10	C3830
121 mm	10	C3830IP
144 mm	10	C3840*
144 mm	10	C3840IP

Compact Snipe Needle Nose Pliers with Orange PVC Handle



C3630/C3640

130 mm	10	C3630
130 mm	10	C3630IP
145 mm	10	C3640
145 mm	10	C3640IP

* Until stocks last



Snipe Nose Pliers with Synthetic Handles and Mirror Polish Finish



2656S

132 mm	1 2656 S

Snipe Nose Pliers with Dual-Component Handles and Lacquered Finish



2470G

3.0 mm 1.5 mm 1.0 mm	165 mm	5 2470 G-160
3.0 mm 1.5 mm 1.0 mm	210 mm	5 2470 G-200

Extra Long Snipe Nose Pliers with PVC Coated Handles and Fine Polish Finish



158-N

280 mm	12 158-N

ERGO™ 45° Bent Tip Snipe Nose Pliers with Self-Opening Dual-Component Handles and Phosphate Finish



2427G

3.0 mm 1.8 mm 1.6 mm	160 mm	5 2427 G-160
3.0 mm 1.8 mm 1.6 mm	200 mm	5 2427 G-200
3.0 mm 1.8 mm 1.6 mm	160 mm	5 2427 G-160 IP
3.0 mm 1.8 mm 1.6 mm	200 mm	5 2427 G-200 IP

ERGO™ 45° Bent Tip Snipe Nose Pliers with Self-Opening Dual-Component Handles and Chrome Finish



2427GC

3.0 mm 1.8 mm 1.6 mm	160 mm	5 2427 GC-160IP
3.0 mm 1.8 mm 1.6 mm	200 mm	5 2427 GC-200IP

45° Bent Tip Snipe Nose Pliers with Monomaterial Handles and Phosphate Finish



2427D

3.0 mm 1.8 mm 1.6 mm	160 mm	5 2427 D-160
3.0 mm 1.8 mm 1.6 mm	200 mm	5 2427 D-200

ERGO™ 60° Bent Tip Snipe Nose Pliers with Dual-Component Handles and Phosphate Finish



4833



130 mm



3 4833

60° Bent Tip Snipe Nose Pliers with Synthetic Handles and Mirror Polished Finish



2656R



129 mm



1 2656 R



Compact Needle Snipe Nose Pliers with 45° Bent Tip and Orange PVC Handle



C3745



141 mm

141 mm



10 C3745
10 C3745IP

45° Bent Tip Snipe Nose Pliers with Dual-Component Handles and Lacquered Finish



2477G-200



3.0 mm

3.0 mm



1.5 mm

1.5 mm



1 mm

1 mm



165 mm

210 mm



5 2477G-160
5 2477 G-200

Compact 90° Bent Tip Snipe Nose Pliers with Orange PVC Handle



C3790



125 mm

125 mm



10 C3790
10 C3790IP

35° Bent Tip Extra Long Snipe Nose Pliers with PVC Coated Handles and Fine Polished Finish



158-NB



270 mm



12 158-NB



ERGO™ Short Flat Nose Pliers with Self-Opening Dual-Component Handles and Phosphate Finish



2420G



125 mm
125 mm



5 2420 G-125
5 2420G-125IP

ERGO™ Long Flat Nose Pliers with Self-Opening Dual-Component Handles and Phosphate Finish



2421G



140 mm
160 mm
180 mm
140 mm
160 mm
180 mm



5 2421 G-140
5 2421 G-160
5 2421 G-180
5 2421 G-140IP
5 2421 G-160 IP
5 2421 G-180 IP

ERGO™ Long Flat Nose Pliers with Self-Opening Dual-Component Handles and Chrome Finish



2421GC



140 mm
160 mm
180 mm



5 2421GC-140IP
5 2421GC-160IP
5 2421GC-180IP

Long Flat Nose Pliers with Monomaterial Handles and Phosphate Finish



2421D



140 mm
160 mm
180 mm



5 2421 D-140IP
5 2421 D-160IP
5 2421 D-180IP

ERGO™ Connector Pliers with Self-Opening Dual-Component Handles and Phosphate Finish



7835G



3.0 mm



1.8 mm



1.6 mm



160 mm



5 7835 G-160

ERGO™ Flat Nose Pliers with Dual-Component Handles and Phosphate Finish



4430



135 mm



3 4430

Compact Flat Nose Pliers with Orange PVC Handle



C3430



129 mm
129 mm



10 C3430
10 C3430IP

Flat Nose Nut Pliers with PVC Coated Handles and Phosphate Finish



2979D



180 mm



5 2979 D-180

Flat Nose Pliers with Synthetic Handles and Mirror Polish Finish



2646MF



120 mm



1 2646 MF



ERGO™ Round Nose Pliers with Self-Opening Dual-Component Handles and Phosphate Finish



2521G



140 mm
160 mm
140 mm
160 mm



5 2521 G-140
5 2521G-160
5 2521G-140IP
5 2521 G-160 IP

Long Flat Nose Pliers with Dual-Component Handles and Lacquered Finish



2471G



180 mm
165 mm



5 2471 G-180
5 2471 G-160

Round Nose Pliers with Monomaterial Handles and Phosphate Finish



2521D



140 mm
160 mm



5 2521D-140IP
5 2521D-160IP



ERGO™ Compact Round Nose Pliers with Dual-Component Handles and Phosphate Finish



4530



135 mm

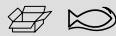

3 4530

Compact Round Nose Pliers with Orange PVC Handle



C3530



127 mm

127 mm



10 C3530
10 C3530IP

Chain Nose Pliers with Synthetic Handle



2646MS



120 mm



1 2646 MS



WATERPUMP PLIERS

ERGO™ Slip Joint Water Pump Pliers with Dual-Component Handles and Phosphate Finish



8223 - 8226



210 mm

250 mm

315 mm

400 mm

210 mm

250 mm

315 mm



4 8223
4 8224
4 8225
1 8226
4 8223 IP
4 8224 IP
4 8225 IP



ERGO™ Slip Joint Water Pump Pliers with Dual-Component Handles and Chrome Finish



8224/8225C



250 mm

315 mm



4 8224CIP
4 8225CIP



ERGO™ Extra Wide Jaw Slip Joint Water Pump Pliers with Dual-Component Handles and Phosphate finish



8231



51 mm

51 mm



225 mm

225 mm







4 8231
4 8231 IP



Quick Adjust Slip Joint Water Pump Pliers with Phosphate Finish







7223-7225

		 
45 mm	200 mm	4 7223
63 mm	250 mm	4 7224
70 mm	300 mm	8 7225
45 mm	200 mm	8 7223IP
63 mm	250 mm	4 7224IP
70 mm	300 mm	4 7225IP

Box Joint Water Pump Pliers with PVC Handle







6221D-6225D

		 
6	125 mm	10 6221D
8	150 mm	10 6222D
10	200 mm	8 6223D
11	250 mm	5 6224D
13	300 mm	10 6225D
6	125 mm	10 6221D IP
8	150 mm	10 6222D IP
10	200 mm	8 6223D IP
11	250 mm	5 6224D IP
13	300 mm	5 6225D IP

Quick-Adjust Water Pump Pliers with PVC Handle







7223D_7225D

		 
16	200 mm	8 7223D*
25	300 mm	4 7225D*
16	200 mm	8 7223D IP*
25	300 mm	4 7225D IP*

Box Joint Water Pump Pliers with Dual-Component Handles and Phosphate Finish







2971G

		 
35 mm	250 mm	5 2971G-250

Box Joint Water Pump Pliers with Dual-Component Handle



6224

		 
11	250 mm	4 6224

Screw Joint Water Pump Pliers with PVC Coated Handles and Phosphate Finish



221 D - 225 D

	 
117 mm	5 221 D
150 mm	5 222 D
192 mm	5 223 D
240 mm	5 224 D
305 mm	5 225 D

* Until stocks last



Screw Joint Water Pump Pliers with PVC Coated Handles and Chrome Finish



5223 - 5226 DC

105 mm	400 mm	1	5226 DC*

Connector Pliers with PVC Coated Handles and Chrome Finish



2650

65 mm	235 mm	1	2650
	235 mm	1	2650 B

Box Joint Water Pump Pliers Set - 3 Pcs



622-3P

110 x 50 x 390 mm	3	1260 g	1	622-3P

6223D, 6224D, 6225D

Water Pump Pliers Set - 3 Pcs



7224-622XD-3P

75 x 50 x 260 mm	3	813 g	1	7224-622XD-3P

6221D, 6224D

7224

CIRCLIP PLIERS

Internal Circlip Pliers with Straight Jaws and Phosphate Finish



2800





8-13 mm	0.8 mm	140 mm	3	2800-140
12-25 mm	1.2 mm	150 mm	3	2800-150
19-60 mm	1.7 mm	180 mm	3	2800-180
40-100 mm	2.2 mm	225 mm	3	2800-225
85-165 mm	3.1 mm	310 mm	1	2800-300

Internal Circlip Pliers with 90° Offset Jaws and Phosphate Finish



2890





8-15 mm	0.8 mm	127 mm	3	2890-125
12-25 mm	1.2 mm	127 mm	3	2890-140

				
19-60 mm	1.7 mm	180 mm	3	2890-180
40-100 mm	2.2 mm	210 mm	3	2890-210
85-165 mm	3.1 mm	300 mm	1	2890-300

Internal Circlip Pliers with Straight Jaws and Chrome Finish







2461

				
8-25 mm	1.0-2.0 mm	140 mm	1	2461 C8
19-60 mm	2.0-2.5 mm	180 mm	1	2461 C19
40-100 mm	2.5-3.5 mm	255 mm	1	2461 C40

Internal Circlip Pliers with 90° Offset Jaws and Chrome Finish







2463





				
8-25 mm	1.0-2.0 mm	130 mm	1	2463 D8
19-60 mm	2.0-2.5 mm	170 mm	1	2463 D19
40-100 mm	2.5-3.5 mm	210 mm	1	2463 D40

External Circlip Pliers with Straight Jaws and Phosphate Finish



2900





				
3-10 mm	0.8 mm	140 mm	3	2900-140
10-25 mm	1.2 mm	150 mm	3	2900-150

				
19-60 mm	1.7 mm	180 mm	3	2900-180
40-100 mm	2.2 mm	215 mm	3	2900-215
85-165 mm	3.1 mm	300 mm	1	2900-300

External Circlip Pliers with 90° Offset Jaws and Phosphate Finish







2990

				
3-10 mm	0.8 mm	12 mm	3	2990-125
10-25 mm	1.2 mm	127 mm	3	2990-140
19-60 mm	1.7 mm	180 mm	3	2990-180
40-100 mm	2.2 mm	200 mm	3	2990-200
85-165 mm	3.1 mm	300 mm	1	2990-300

External Circlip Pliers with Straight Jaws and Chrome Finish



2464

				
3-10 mm	1.0-1.5 mm	120 mm	1	2464 A3
10-25 mm	1.5-2.0 mm	120 mm	1	2464 A10
19-60 mm	2.0-2.5 mm	180 mm	1	2464 A19
40-100 mm	2.5-3.0 mm	210 mm	1	2464 A40



External Circlip Pliers with 90° Offset Jaws and Chrome Finish



2466

⌀	⌀	L	📦	🔗
3-10 mm	1.0-1.5 mm	130 mm	1	2466 B3
10-25 mm	1.5-2.0 mm	130 mm	1	2466 B10
19-60 mm	2.0-2.5 mm	165 mm	1	2466 B19
40-100 mm	2.5-3.0 mm	190 mm	1	2466 B40

Internal and External Circlips Resettable Pliers



2928

⌀	⌀	L	📦	🔗
7-26 mm	3-26 mm	160 mm	1	2928-160
10-51 mm	7-51 mm	200 mm	1	2928-200
46-102 mm	38-102 mm	250 mm	1	2928-250

Spare Tips for 2928 Series Resettable Circlips Pliers



2928-1 - 4

🔗	📦	🔗
2928-160	1	2928-1
2928-200	1	2928-2
2928-250	1	2928-3
2928-250	1	2928-4

External Horseshoe Circlip Pliers with Chrome Finish



2460

L	📦	🔗
175 mm	1	2460

External Horseshoe Circlip Pliers with Nickel-Chrome Finish and PVC Coated Handles



2465D

L	📦	🔗
200 mm	1	2465D-200

Internal and External Circlip Pliers Set - 4 Pcs



28-29/S4

g	📦	🔗
740 g	1	28-29/S4

2900-180	🔗	🔗
2800-180	🔗	🔗
2990-180	🔗	🔗
2890-180	🔗	🔗

Resettable Circlip Pliers Set - 3 Pcs



9938

1640 g	1	9938

2928-160, 2928-200, 2928-250



WIRE STRIPPERS & DISMANTLING TOOLS

ERGO™ Wire Stripping Pliers with Self-Opening Dual-Component Handles and Phosphate Finish



2223G

0.5-5 mm	165 mm	5	2223 G-150

Wire Stripping Pliers with Monomaterial Handles and Phosphate Finish



2223D

0.5-5 mm	165 mm	5	2223 D-150

Automatic Wire Stripping Pliers



3416 B

0,02-10 mm ²	34-8 AWG	10	3416 B

Automatic Wire Stripping Pliers



3416 A

0,2-6 mm ²	24-10 AWG	6	3416 A
		1	3416 A SH



Automatic Wire Stripping Pliers with Built in Side Cutter and Integrated Scale



3418 A

20-10 AWG	0,5-6 mm ²	3 mm	160 mm	1	3418 A

Rotating dismantling tool. 3518ASH spare blade



3518 A

4-28 mm	185 mm	1	3518 A
		1	3518 ASH

Rotating dismantling tool



3520 B

4,5-40 mm	167 mm	10	3520 B
		10	3520 B SH

Universal dismantling tool with hidden knife



3518 B

0,5-6 mm ²	125 mm	1	3518 B

Rotating dismantling tool



3520 A

0,5-6 mm ²	1	3520 A
	1	3520 A SH

Wire Stripping Pliers with Anti-Slip Handle



3517 A

6-13 mm	120 mm	1	3517 A

Stripping Tool for PVC Data Cables



3717 A

115 mm	4.5-10 mm mm	28 g	1	3717 A

Precision Stripping Tool



3719 A

0,12-0,8 mm mm	36-20 AWG	112 mm	12	3719 A

Wire Stripping Tools for Coaxial Cables



3417 A

4.8-7.5 mm	110 mm	12	3417 A

Insertion Tool for LSA Blocks



3718 A

185 mm	0,7-2,6 mm	60 g	12	3718 A

Precision stripping pliers for data cables



3619 A

2,5-11 mm	91 mm	10	3619 A
		10	3619 A SH

Self-Adjusting Automatic Wire Stripping Pliers with Built in Wire Cutter



3419 B

0.25-6.00 mm	1	3419 B
	1	3419 B SH



CRIMPING PLIERS

Crimping/Cutting/Stripping Pliers with Yellow Handle



CR B 01

	AWG			
0.50-6.00 mm ²	20-10	220 mm	60	CR B 01

Crimping/Cutting/Stripping Pliers with Red Handle



CR B 02

	AWG			
1.50-6.00 mm ²	14-10	220 mm	60	CR B 02

Crimping/Cutting/Stripping Pliers with Green Handle



CR B 03

	AWG			
1.50-6.00 mm ²	14-10	220 mm	60	CR B 03

Crimping Pliers for Round Pattern Cable Connections 0.5-2.5 mm²



CR B 05

	AWG			
0.5-2.5 mm ²	20-14	140 mm	2	CR B 05

Crimping Pliers for Round Pattern Cable Connections 0.5-16 mm²



CR B 06

	AWG			
0.5-16 mm ²	20-6	220 mm	2	CR B 06

Ratcheting Crimping Pliers for Insulated Connectors - Oval Profile





CR OV 01

	AWG			
0.5-6.0 mm ²	20-10	256 mm	1	CR OV 01

Ratcheting Crimping Pliers for Insulated Connectors





CR W 01

	AWG		
0.5-6.0 mm ²	20-10	225 mm	1 CR W 01

Ratcheting Crimping Pliers for High Quality Crimping Connections





CR W 04

		
RG 58-59-62 mm ²	225 mm	1 CR W 04

Ratcheting Crimping Pliers for Non-insulated Connectors





CR W 02

	AWG		
0.5-10 mm ²	20-8	225 mm	1 CR W 02

Ratcheting Crimping Pliers for Tubular Connectors 0.5 AWG-4.0 AWG





CR W 05

AWG		
0.5-4.0	225 mm	1 CR W 05

Ratcheting Crimping Pliers for Open Plug Type Connectors





CR W 03

	AWG		
0.5-6.0 mm ²	20-10	225 mm	1 CR W 03

Ratcheting Crimping Pliers for Tubular Connectors 6 AWG-16 AWG



CR W 06

AWG		
6-16	225 mm	1 CR W 06



Self-Adjusting Crimping Pliers - Square Profile



CR SA S01



	AWG			
0.14-10 mm ²	26-8	176 mm	1	CR SA S01

Heavy Duty Crimping Pliers for Non-insulated Connectors 600 mm



CR L 01

10-120 mm ²	10-95 mm ²	600 mm	1	CR L 01

Self-Adjusting Crimping Pliers - Hexagonal Profile



CR SA H01



	AWG			
0.14-10 mm ²	26-8	176 mm	1	CR SA H01
0.14-16 mm ²	26-6	176 mm	1	CR SA H16

Heavy Duty Crimping Pliers for Non-insulated Connectors 360 mm



CR L 02

6-50 mm ²	360 mm	1	CR L 02

Self-Adjusting Crimping Pliers - Trapezoidal Profile



CR SA T01



	AWG			
0.14-10 mm ²	26-8	180 mm	1	CR SA T01

Heavy Duty Crimping Pliers for Non-insulated Connectors 650 mm



CR L 03

25-150 mm ²	650 mm	1	CR L 03

PLIERS SETS

ERGO™ Fine Mechanical Cutters and Pliers Set - 8 Pcs



ergo®



9733



30 x 215 x 215 mm



8



1 9733

4130, 4131



4239



4830



4530



4231



4430



4833



Compact Cutters and Pliers Set C3330R, C3840 and C3745 - 3 Pcs



C3902/3



3



1 C3902/3

C3330R



C3840



C3745



Compact Pliers and Screwdrivers Set - 8 pcs



C3903/2-6



8



1 C3903/2-6

C3330R



C3840



700-1.5-50, 700-2-50, 700-2.5-50, 700-3-50



701-0-50, 701-1-75



ERGO™ Plumber's Set with 9031 Adjustable Wrench - 2 Pcs



ergo®



9031-8224



2



693 g



3 9031-8224

9031



8224



ERGO™ Plumber's Set with 9072P Adjustable Wrench - 2 Pcs



ergo®



9873



25 x 190 x 280 mm



2



1 9873

9072 P



8224



All Round Tool Set - 3 Pcs



9853

25 x 252 x 292 mm	3	1 9853

9071	
2101G-160	
8224	

ERGO™ All Round Pliers Tool Set - 4 Pcs



9897

4	1030 g	1 9897

8224	
2628 G-180	
2101G-160	
2430 G-160	

ERGO™ All-Round Pliers Tool Set - 3 pcs



9897G/3

3	50 x 180 x 400 mm	788 g	1 9897G/3

2628 G-180	
2101G-160	
2430 G-200	

LOCKING PLIERS

Grip Locking Pliers with Curved Jaws



2951

1.2 mm	140 mm	1 2951-140
2 mm	190 mm	1 2951-180
3 mm	235 mm	1 2951-250
4 mm	300 mm	1 2951-300

Self Grip Locking Pliers with Curved Jaws



2953

140 mm	1 2953-140
190 mm	1 2953-200
235 mm	1 2953-250
300 mm	1 2953-300

Grip Locking Pliers with Straight Jaws



2958



135 mm	1	2958-140
190 mm	1	2958-200
235 mm	1	2958-250

Grip Locking Pliers with Long and Slim Jaws



2952



155 mm	1	2952-165
230 mm	1	2952-235

Grip Locking Pliers with Flat Jaws and Longitudinal Section



2968



205 mm	1	2968-190
235 mm	1	2968-235

Special Grips for Sheet Metals with Nickel Finish



2967



180 mm	1	2967-180
--------	---	----------

Grip and Welding Pliers with Multipurpose Jaws



2957



250 mm	1	2957-250
--------	---	----------

Grip Locking Pliers with Parallel Jaws



2955



235 mm	1	2955-250
--------	---	----------



Locking Chain Clamps with Nickel Finish



2999



230 mm
500 mm



1 2999-250
1 2999-SHN

Grip Locking Clamps with C-Clamp



2963



283 mm
458 mm
580 mm



1 2963-280
1 2963-450
1 2963-630

Chain Pipe Cutters with Chrome Finish



2998



240 mm
330 mm



1 2998-250
1 2998-SHN

Self Adjusting Grip Locking Clamps with Parallel C-Clamp



2964



175 mm
280 mm
436 mm
625 mm



1 2964-160
1 2964-280
1 2964-450
1 2964-600

Table Locking Clamp



2960



280 mm



1 2960-280

Self Adjusting Parallel Grip Pliers with Swivel Pads



2950



235 mm



1 2950-250

Steel Clamp, Swivel Pads, Slim



2956



282 mm



1 2956-290

Special Grips for Tubes and Pipes



2966



290 mm



1 2966-280

Stepped C Clamps



2962



290 mm

290 mm

290 mm



1 2962-8-150

1 2962-8-230

1 2962-8-300

Locking Pliers Spare Parts



2951-S



43 mm

46 mm

62 mm

87 mm



15 g

25 g

50 g

70 g



1 2951-S05

1 2951-S07

1 2951-S10

1 2951-S12

Special Grip and Locking U-Clamps



2965



228 mm

290 mm



1 2965-200

1 2965-280

Universal Grip Pliers with 4 Positions Long Jaws



2997



255 mm



5 2997-300



Universal Grip Pliers with 4 Positions Short Jaws



2997-250



235 mm



1 2997-250

Automatic Hand Vices with Phosphate Finish



2949



193 mm
196 mm
240 mm
240 mm



1 2949-190IP
1 2949-200IP
1 2949-240IP
1 2949-250IP

Hand Vices Spare Bolt



2949-L



2949-190IP
2949-200IP, 2949-240IP
2949-250IP

75 mm
120 mm
200 mm



1 2949-L075
1 2949-L120
1 2949-L200

RIVETING TOOLS

Hand Riveters with 360° Swivel Head



2681



285 mm



12 2681

Hand Riveters with Exchangeable Heads



1467-250



255 mm



1 1467-250

Notching pliers.



2690



200 mm



10 2690

Spare Parts for 1467 Series Riveter



1467



10 g
10 g



1 1467-LJ
1 1467-SJ

Long Arm Riveters with Transparent Tube Collects



1467-520



530 mm



1 1467-520

Spare Part Set for 2681 Series Riveter - 4 Pcs



2681-1



15 g



1 2681-1

Extensible Riveters for Cu/Al and Stainless Steel



1467-320-850



850 mm



1 1467-320-850

SPECIAL PLIERS

Automatic Wire Tie Tensioning Tools for Electric Nylon Ties



790450A



<2.2x5 mm



1 790450A



Wire Tie Tensioning Tools for Electric Nylon Ties



790455A



<9.5x2.3 mm



1 790455A

Wire Twisting Pliers with Phosphate Finish



2855



236 mm
287 mm



1 2855
1 2855 D

Wire Twisting Pliers, One-hand Operation



2856



203 mm
268 mm



1 2856-8*
1 2856-10*



Pipe Wrenches & Tubing Tools



PIPE WRENCHES

ERGO™ Quick-Adjust Pipe Wrenches



ergo



1610/1620

L	max		
320 mm	1 in	1	1610
430 mm	1 1/2 in	1	1620

10 times faster vs standard model

ERGO™ Swedish Model 90° Pipe Wrenches



ergo



1410/1420

L	max		
320 mm	1 in	1	1410
430 mm	1 1/2 in	1	1420

ERGO™ Swedish Model 90° Pipe Wrenches with Soft-Touch Shank



ergo



1410D/1420D

L	max		
320 mm	1 in	1	1410D
430 mm	1 1/2 in	1	1420D

Swedish Model 90° Pipe Wrenches



140-147

L	max		
210 mm	3/4 in	1	140
320 mm	1 in	1	141
426 mm	1 1/2 in	1	142
557 mm	2 1/2 in	1	143
722 mm	3 1/2 in	1	144
1060 mm	5 in	1	147

Spare Nuts for Quick-Adjust Pipe Wrenches



1610-nut/1620-nut

Ø	g		
11 mm	34 g	1	1610-NUT
11.5 mm	48 g	1	1620-NUT

Swedish Model 90° Pipe Wrench with Green Powder Coat



DOW175

L	max		
310 mm	1 in	1	DOW 175-1
420 mm	1 1/2 in	1	DOW 175-11/2
560 mm	2 in	1	DOW 175-2
630 mm	3 in	1	DOW 175-3

Corner Pipe Wrench



442 B-444 B

L	max		
320 mm	1 in	1	442 B
430 mm	2 in	1	443 B
545 mm	2 1/2 in	1	444 B

Swedish Model Corner Combination Pipe Wrench



341-344

L	max		
230 mm	1/2 in	1	341
330 mm	1 in	1	342
420 mm	1 1/2 in	1	343
530 mm	2 in	1	344

Swedish Model Corner Combination Pipe Wrench with Green Powder Coat



DOW177

L	max		
325 mm	1 in	1	DOW 177-1/2-1
425 mm	1 1/2 in	1	DOW 177-11/2
534 mm	2 in	1	DOW 177-2

Swedish Model 45° Corner Pipe Wrench with Green Powder



DOW176

L	max		
330 mm	1 in	1	DOW 176-1
415 mm	1 1/2 in	1	DOW 176-11/2
530 mm	2 in	1	DOW 176-2

Heavy Duty Chain Pipe Wrenches



372

L			
1.1 in		1	372-1.1/2
2.1 in		1	372-2.1/2
4 in		1	372-4
6 in		1	372-6
8 in		1	372-8
12 in		1	372-12

Special Pipe Wrenches with Nylon Strap and Steel Handle



375

L			
300 mm		1	375-8

Multipurpose Aluminium Pipe Wrenches



380

L	max		
253 mm	1.1/2 in	1	380-10
320 mm	2 in	1	380-14
455 mm	2.1/2 in	1	380-18
607 mm	3 in	1	380-24
910 mm	4 in	1	380-36
1210 mm	6 in	1	380-48

Spare Chains For Special Pipe Wrenches



3074

L			
340 mm	372-1.1/2	1	307401B
475 mm	372-2.1/2	1	307411B
700 mm	372-4	1	307421B
850 mm	372-6	1	307431B
1000 mm	372-8	1	307441
1400 mm	372-12	1	307451

Telescopic Basin Wrenches with 4 Positionings



363

L			
280 mm		1	363-32

Stillson Pipe Wrenches



361

L	max		
185 mm	1 in	1	361-8
230 mm	1.1/2 in	1	361-10
265 mm	1.3/4 in	1	361-12
315 mm	2 in	1	361-14
450 mm	2.1/2 in	1	361-18
535 mm	3 in	1	361-24
900 mm	4 in	1	361-36

Chain Pipe Wrenches with Steel Handle



370

L			
300 mm		1	370-4

TUBE CUTTING TOOLS

Pipe Cutters



401-16

3-16 mm		12	401-16



Pipe Cutters 3 mm-28 mm



401-28



3-28 mm



12 401-28

Automatic Tube Cutter 10-22 mm



306-



10 mm
12 mm
15 mm
22 mm



1 306-10
1 306-12
12 306-15
12 306-22

Tube Cutter 8-35 mm



302-35



3-35 mm



6 302-35

Pipe Cutters 3 mm-35 mm



402-35



3-35 mm



6 402-35

Compact Tube Cutter 3-16 mm



301-16



3-16 mm



72 mm



12 301-16

Tube Cutter 35-75 mm



302-76



1 302-76-95*

Pipe Cutters with Quick Adjust System



402-76



12-76 mm



6 402-76*

Compact Tube Cutter 3-22 mm



301-22



3-28 mm



12 301-22

Tube Cutter with Quick Adjust System
12-76 mm



302-76N



12-76 mm



318 mm



6 302-76N

Spare Cutting Wheels for 301/302 & 401/402 Series Tube Cutters



302/402-15-95

g	Icons	Quantity	Part Number
5 g		100	302-15-95
5 g		1	402-15-95

Spare Wheels and Pins for 401/402 Pipe Cutters



402-95-SET

g	Icons	Quantity	Part Number
30 g		1	402-95-SET

Plastic Pipe Scissors for PEX



412-28-PEX

mm	Icons	Quantity	Part Number
28 mm		5	412-28-PEX

Spare Wheels Set and Pin for 301/302 Pipe Cutters



302-95-SET

g	Icons	Quantity	Part Number
30 g		1	302-95-SET

Plastic Tube Cutter



311-32

mm	Icons	Quantity	Part Number
32 mm		6	311-32

Plastic Pipe Scissors for Multilayer



412-26-MULTI

mm	Icons	Quantity	Part Number
26 mm		5	412-26-MULTI

Spare Cutting Wheels for 306 Series Tube Cutters



306-15-95

g	Icons	Quantity	Part Number
10 g		1	306-15-95

Plastic Pipe Scissors



411

mm	Icons	Quantity	Part Number
26 mm		4	411-26
35 mm		4	411-35
42 mm		6	411-42
63 mm		5	411-63

Spare Blades for Plastic Pipe Scissors



411-95

mm	g	Icons	Quantity	Part Number
26 mm	39 g		50	411-26-95
35 mm	37 g		50	411-35-95
42 mm	41 g		50	411-42-95
63 mm	48 g		30	411-63-95

* Until stocks last



Spare Blades for 412-28-PEX Pipe Scissors



412-28-PEX-95

1	35 g	30	412-28-PEX-95

Spare Blades for 412-26-MULTI Plastic Pipe Cutters



412-26-MULTI-95

1	10 g	150	412-26-MULTI-95

BENDING & FORMING TOOLS

Multipurpose Tube Bender



1084

250 mm	6,8 10 mm	5	1084

Tube Bender



500

12 mm	1	500-12
14 mm	1	500-14
15 mm	1	500-15
16 mm	1	500-16
18 mm	1	500-18
22 mm	1	500-22

Tube Flaring Tool In Metric Sizes



4480MM

45°	1	4480MM
4, 6, 8, 10, 12, 14, 16, 18 mm		

Imperial Tube Flaring Tool



4480IM

45°	1	4480IM
5/8, 3/16, 1/4, 5/16, 3/8, 7/16, 1/2, 3/4 in		

Tube Cutter and Double Flaring Tool Set



4480/

45 x 140 x 330 mm	1	4480/2-ZD

DEBURRING TOOLS

Aluminium Pen Reamer



316-1

143 mm	12	316-1

Plastic Pen Reamer



316-2

150 mm	12	316-2

Spare Blade for 316-2 Pen Reamer



316-2-95



3 g



1 316-2-95

Aluminium Wheel Reamer



318-38/318-54



8-38 mm
10-54 mm



1 318-38
1 318-54

Plastic Wheel Reamer



317-40



3-40 mm



12 317-40





BAHCO®



Air Tools



IMPACT WRENCHES

3/8" Square Drive Mini Impact Wrenches



BP704

BAR
6.3 bar 1500 min 1 BP704

1/2" Square Drive Angle Impact Wrenches with Jumbo Hammer Mechanism



BP814A

BAR
7000 min 6.2 bar 10 BP814A

1/2" Impact Wrenches with Twin Hammer Mechanism 360 N.m



BP814

BAR
10,000 min 6.3 bar 10 BP814*

1/2" Impact Wrenches with Twin Hammer Mechanism 620 N.m



BP815

BAR
7,000 min 6.3 bar 1 BP815

1/2" Impact Wrench Kit - 13 Pcs



BP815K1

BAR
7,000 min 6.3 bar 1 BP815K1*

BP815

K7800M-10, K7800M-11, K7800M-12, K7800M-13, K7800M-14, K7800M-15, K7800M-17, K7800M-19, K7800M-22, K7800M-24, K7800M-21

PM5142

1/2" Square Drive Micro Impact Wrenches with Twin Hammer Mechanism



BPC813

BAR
10000 min 6.3 bar 10 BPC813

1/2" Square Drive Micro Impact Wrench Set with Ultra Short Sockets



BPC813K1

BAR
1/2 in 65 x 162 x 215 mm 1 BPC813K1*

BPC813

K7800M-13, K7800M-14, K7800M-16, K7800M-17, K7800M-19, K7800M-21, K7800M-22, K7800M-24

1/2" Composite Impact Wrenches with Twin Hammer Mechanism 338 N.m



BPC814

BAR
12000 min 6.3 bar 10 BPC814

1/2" Composite Impact Wrenches with Twin Hammer Mechanism 786 N.m



BPC815

BAR
8000 min 6.3 bar 1 BPC815

1/2" Square Drive Impact Wrench Set with 11 Metric Sockets



BPC815K1

1/2 in	90 x 230 x 390 mm	1 BPC815K1*

BPC815

K7801Z-1/2, K7801Z-5/8, K7801Z-3/4, K7801Z-7/8, K7801Z-15/16

1/2" Square Drive Impact Wrench Set with 5 Metric Sockets



BPC815K2

1/2 in	90 x 230 x 320 mm	1 BPC815K2

BPC815

K7801M-10, K7801M-11, K7801M-12, K7801M-13, K7801M-14, K7801M-15, K7801M-17, K7801M-19, K7801M-21, K7801M-22, K7801M-24

1/2" Square Drive Impact Wrench Set with 5 Imperial Sockets



BPC815K3

1/2 in	90 x 230 x 320 mm	1 BPC815K3*

BPC815

K7801Z-1/2, K7801Z-5/8, K7801Z-3/4, K7801Z-7/8, K7801Z-15/16

1/2" Square Drive Impact Wrench Set with 5 Wheel Metric Sockets



BPC815K4

1/2 in	90 x 230 x 320 mm	1 BPC815K4*

BPC815

BWSS12P5

1/2" Square Drive Impact Wrench Set with 2 Wheel Metric Sockets



BPC815K6

1/2 in	90 x 230 x 320 mm	1 BPC815K6*

BPC815

BWSS12P317, BWSS12P319

3/4" Impact Wrenches with Twin Hammer Mechanism 950 N.m



BP817

	BAR	
4,500 min ⁻¹	6.3 bar	1 BP817

3/4" Square Drive Lightweight Impact Wrenches with Twin Hammer Mechanism



BPC817

	BAR	
5000 min ⁻¹	6.2 bar	4 BPC817

3/4" Square Drive Impact Wrench Set with 4 Metric Sockets



BPC817K1

3/4 in	105 x 295 x 390 mm	1 BPC817K1*

BPC817

K8901M-24, K8901M-27, K8901M-32, K8901M-30

* Until stocks last



3/4" Square Drive Impact Wrench Set with 4 Imperial Sockets



BPC817K2

3/4 in	105 x 295 x 390 mm	1 BPC817K2*

BPC817

K8901Z-15/16, K8901Z-1, K8901Z-1.1/16, K8901Z-1.1/8

1" Square Drive Lightweight Impact Wrenches with Durable Rocking Dog Mechanism



BP901

3800 min	6.2 bar	1 BP901

1" Square Drive Lightweight Impact Wrenches with Durable Rocking Dog Mechanism and 9" Anvil



BP901L

3800 min	6.2 bar	1 BP901L

1" Square Drive Lightweight Impact Wrenches with Twin Hammer Clutch Mechanism



BP905P

6000 min	6.2 bar	2 BP905P

1" Square Drive Lightweight Impact Wrenches with Twin Hammer Mechanism and Long Anvil



BP905L

6000 min	6.2 bar	2 BP905L

RATCHETS

1/4" Mini Air Ratchets with Power Regulator



BP700

300 min	6.3 bar	20 BP700

3/8" Square Drive Stubby Air Ratchets



BP721

350 min	6.3 bar	1 BP721*

3/8" Air Ratchets with Power Regulator



BP820

270 min	6.3 bar	1 BP820*

1/2" Ratchets with Rubber Grip



BP821

150 min	6.3 bar	1 BP821

Air Ratchet Boots for 1/4" Ratchets



BP91B

35 x 40 x 60 mm	12 g	1 BP91BL	
30 x 30 x 45 mm	6 g	1 BP91BS	

Low Speed Air Grinder/Tyre Buffers with Keyed Chuck



BP118

	BAR		
2500 min	6.3 bar	1 BP118*	

Coarse Grinding Bullet Abrasive Wheels with 6 mm Shank - 2 Pcs/Blister Pack



BP421M

53 mm	14 mm	1 BP421M*	

GRINDERS, SANDERS & POLISHERS

Angle Die Grinders with Rubber Grip



BP115

	BAR		
20,000 min	6.3 bar	1 BP115	

Die Grinders with Rubber Grip



BP822

	BAR		
25,000 min	6.3 bar	1 BP822	

Coarse Grinding Spherical Abrasive Wheels with 6 mm Shank - 2 Pcs/Blister Pack



BP423M

53 mm	25 mm	1 BP423M*	

Low Revolution Air Grinder/Tyre Buffers with Hex Quick Change Chuck



BP117

	BAR		
2500 min	6.3 bar	1 BP117*	

Air Die Grinders with 6 mm Shank, Long Anvil and Rubber Grip



BP822E

	BAR		
25000 min	6.3 bar	10 BP822E	

Coarse Grinding 90° Cone Abrasive Wheels with 6 mm Shank - 2 Pcs/Blister Pack



BP424M

57 mm	19 mm	1 BP424M*	

* Until stocks last



Fine Grinding Conical Round Nose
Abrasive Wheels with 3 mm Shank - 2
Pcs/Blister Pack



BP430M



55 mm 12 mm 1 BP430M*

Fine Grinding Small Tapered Ball Abrasive
Wheels with 3 mm Shank - 2 Pcs/Blister
Pack



BP433M



43 mm 14 mm 1 BP433M*

Disc Grinders with Rubber Grip and Safety
Trigger



BP823



10,000 min⁻¹ 6.3 bar 1 BP823

Fine Grinding Small Bullet Abrasive
Wheels with 3 mm Shank - 2 Pcs/Blister
Pack



BP431M



54 mm 13 mm 1 BP431M*

Fine Grinding Small Cylindrical Abrasive
Wheels with 3 mm Shank - 2 Pcs/Blister
Pack



BP434M



45 mm 13 mm 1 BP434M*

4"/102 mm Extended Air Cut-Off Tools



BP111E



15000 min⁻¹ 6.3 bar 12 BP111E*

Fine Grinding Small 90° Cone Abrasive
Wheels with 3 mm Shank - 2 Pcs/Blister
Pack



BP432M



44 mm 15 mm 1 BP432M*

Reversible Cut-Off Tools



BP110



18,000 min⁻¹ 6.3 bar 1 BP110

Exhaust Hoses for BP117 Low Revolution
Grinder/Tyre Buffers



BP117EH



50 x 100 x 50 mm 1 kg 1 BP117EH

Surface Cleaners with 19 Needles



BP127

	BAR		
3700 min	6.3 bar	1	BP127

Coarse Inclined Steel Bristles

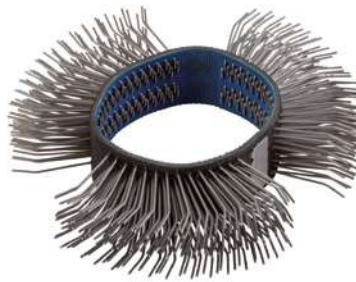

BP830CISB

BP830K	105 mm	1	BP830CISB*

Rubber Eraser, Water Based



BP830EWB

BP830K	105 mm	1	BP830EWB*

Pistol Grip Surface Cleaners with 19 Needles



BP127P

	BAR		
3800 min	6.3 bar	1	BP127P*

Air Blaster Kit



BP830K

	BAR		
4000 min	6.3 bar	4	BP830K*

Straight Steel Bristles

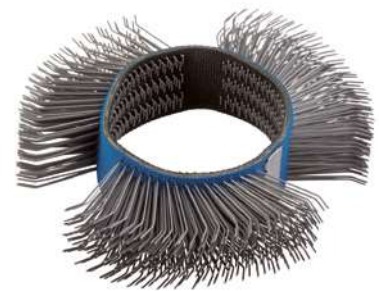

BP830MISB

BP830K	105 mm	1	BP830MISB*

Needle Set



BP12718

BP127, BP127P	3 mm	1	BP12718

Rubber Dish Solvent Based



BP830ESB

30 mm	105 mm	1	BP830ESB*

Straight Bristles Adaptor



BP830SBA

BP830K	105 mm	1	BP830SBA*

* Until stocks last



Straight Steel Bristles



BP830SSB

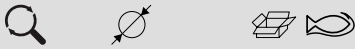

BP830K 105 mm 1 BP830SSB*

Stripping Wheel



BP830SW



BP830K 105 mm 1 BP830SW*

Pistol-Grip Air Sander Set - 71 Pcs



BP204K



15000 min 6.3 bar 1 BP204K*

BP20425180, BP20410800, BP20410320, BP20425220

BP204

Sanding Pads for BP204 Pistol-Grip Sander



BP204PAD

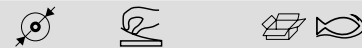

77 mm - 1 BP204PAD*

Belt Sanders with Quick Belt Release Button



BP212



16,000 min 6.3 bar 1 BP212

5 mm Palm Orbital Sanders with Velcro Pad



BP601



152 mm 6.3 bar 1 BP601

Velcro Pad 53 Holes



BP60102



BP601 152 mm 1 BP60102

3" Pistol Grip Orbital Air Sanders with Rubber Grip



BP204



15000 min 6.3 bar 1 BP204*

Sanding Discs for 3" Wheel Sanders



BP204xyyy



77 mm 1 BP20425180*

20 mm Belt Sanders with Quick Belt Release Button



BP222

	BAR		
16,000 min	6.3 bar	1	BP222

2.5 mm Palm Orbital Sanders with Velcro Pad



BP610

	BAR		
152 mm	6.3 bar	1	BP610

Pack of 25 Belts for Belt Sanders



BPN22201/21201

10 mm	1	BPN21201
20 mm	1	BPN22201

7" Air Angle Polishers with Rubber Grip and Spindle Lock



BP809

	BAR		
2500 min	6.3 bar	1	BP809*

7" Vertical Air Polishers with Rubber Grip



BP810

	BAR		
2500 min	6.3 bar	1	BP810*

7" Wool Bonnets



BP80950

178 mm	15 g	1	BP80950

DRILLS & SCREWDRIVERS

1/2" Reversible Drills with Rubber Grip 13 mm



BP825

	BAR		
450 min	6.3 bar	1	BP825

1/2" Reversible Air Drills 800 rpm



BPC825

	BAR		
800 min	6.3 bar	1	BPC825*

3/8" Compact Reversible Air Drills 2,000 rpm



BPC823

	BAR		
2000 min	6.3 bar	1	BPC823*

* Until stocks last



3/8" Compact Angle Air Drills 1,400 rpm



BPA823

	BAR		
1400 min	6.3 bar	1	BPA823*

1/4" Air Screwdrivers 1800 rpm



BP826

	BAR		
1800 min	6.3 bar	1	BP826*

1/4" Air Screwdrivers 800 rpm



BP827

	BAR		
800 min	6.3 bar	1	BP827*

CUTTING TOOLS

Compact Reciprocating Saws with Safety Trigger



BP828

	BAR		
10000 min	6.3 bar	1	BP828

Geared Reciprocating Saws with Safety Trigger



BPG824

	BAR		
7400 min	6.3 bar	10	BPG824*

Windscreen Removers with Low Vibration



BP233

	BAR		
20	6.3 bar	1	BP233

Flat and Jagged Straight Blades



BPBG

15 mm	1	BPBG3515*
25 mm	1	BPBG3525A*
25 mm	1	BPBG3525B*

Scrapers - 2 Pcs/Blister Pack



BPBSC

15 mm	1	BPBSC156*

U Shaped Blades - 2 Pcs/Blister Pack



BPBU

18 mm	1	BPBU18*
24 mm	1	BPBU24*
36 mm	1	BPBU36*
60 mm	1	BPBU60*
90 mm	1	BPBU90*

Air Metal Shears with Rubber Grip and Safety Trigger



BP811

BAR

2,600 min⁻¹ 6.3 bar 1 BP811*

Straight Offset Blades - 2 Pcs/Blister Pack



BPG5725/9057

57 mm 1 BPG5725*
90 mm 1 BPG9057*

HAMMERS, RIVETERS & MARKERS

Air Hammers 3200 bpm



BP910

BAR

6.3 bar 3200 (min⁻¹) 5 BP910

Rotating Flat Chisels with 10.2 mm Shank



BP909TF

170 mm 1 BP909TF*

Rotating Hammer Chisels with 10.2 mm Shank



BP909TH

108 mm 1 BP909TH*

Rotating Tapered Punch Chisels with 10.2 mm Shank



BP909TTP

165 mm 1 BP909TTP*

Rotating Straight Punch Chisels with 10.2 mm Shank



BP909TSP

165 mm 1 BP909TSP*

Rotating Edging Chisels with 10.2 mm Shank



BP909TE

139 mm 1 BP909TE*

Non-Rotating Flat Chisels with 10.2 mm Shank



BP909NF

190.5 mm 1 BP909NF*

* Until stocks last



Non-Rotating Edging Chisels with 10.2 mm Shank



BP909NE



173 mm



1 BP909NE*

Air Riveters 880 kg pulling force



BP277K

BAR



6.3 bar

14



8 BP277K*

Air Riveters 1600 kg pulling force



BP125A

BAR



6.3 bar

19



6 BP125A

Air Engraving Markers with Low Vibration



BP799



BAR

13,000 min⁻¹

6.3 bar



1 BP799

Carbide Tips for Air Engraving Pen



BP79912



10 g



1 BP79912

PAINT GUNS

HVLP Spray Painting Guns



BPHVLP01



0.7 kg

BAR

2-2.8 bar



1 BPHVLP01

Nozzle Set for BPHVLP01 HVLP Painting Spray Guns



BPHVLP



1.2 mm

1.4 mm

1.7 mm

2.0 mm



1 BPHVLP0112

1 BPHVLP0114

1 BPHVLP0117

1 BPHVLP0120

Air Caulking Guns with 300 ml Cartridge Applicator



BP215A

BAR

3.5-4.8 bar



10 BP215A*

BLOWING & CLEANING TOOLS

Air Blow Guns with Brass Inlet



BP218

BAR

6.3 bar



1 BP218

Air Blow Guns with Brass Inlet and Removable Safety Tip



BP219
BAR



6.3 bar 1 BP219

Air Blow Guns with Brass Inlet and Removable Safety Tip Long Nozzle



BP219L
BAR



6.3 bar 1 BP219L

Air Blow Guns with Brass Inlet 1 m Extra Long Nozzle



BP219XL
BAR



6.3 bar 100 l/min 10 BP219XL

Air Blow Vacuum Guns with Removable Safety Tip



BP219V
BAR



6.3 bar 1 BP219V*

Cleaning Guns with Steel Nozzle



BPN010
BAR



6.2 bar 6000-7500 min 1 BPN010

1/2" Filter Regulator Units



BP254



BAR



max 3800 L/min l/min 1-8.5 bar 1 BP254

1/2" Filter Regulator and Lubricator Units



BP255



BAR



max 3,800 l/min 1-8.5 bar 1 BP255

AIR TOOLS ACCESSORIES & EQUIPMENT

Air Blow Guns with Brass Inlet 1 m Extra Long Nozzle



Magnetic Holders for Impact and Torque Wrenches



BP500



0.380 kg 1 BP500*

1/4" Inline Lubricators



BPN251



1/4" in 0.100 kg 1 BPN251

* Until stocks last



1/2" Filter Regulator and Lubricator Units with Type T Clean Dry Air Outlet



BP255T

	BAR		
max 3800 l/min	1-8.5 bar	1	BP255T*

Air Hose Reels with 145° Swivel Steel Bracket and Optional Speed Control Adaptor



BPHRC815/1015

8 mm	15 m	1	BPHRC815
10 mm	14+1 m	1	BPHRC1015

Air Hose Reels with 145° Swivel Steel Bracket



BPHRC1020/1316

10 mm	20 m	1	BPHRC1020
13 mm	15+1 m	1	BPHRC1316

Additional clean dry air outlet for 1/2" filter regulator and lubricator units with type T clean dry air outlet



BP255T-1

	BAR		
max 3800 l/min	1-8.5 bar	1	BP255T-1

Spiral Air Hoses with Threaded Connector 13 mm



BPH1310

1/2"-1/2" in	10 m	1	BPH1310A

1/4" Swivel Air Connectors



BPSJ

1/4" in		1	BPSJ

Spiral Air Hoses with Threaded Connector 10 mm



BPH1010

1/4"-1/4" NPT in	10 m	1	BPH1010A
1/4"-1/4" BSP in	10 m	1	BPH1010B

Speed Control Adaptors for Rewinding Speed Control



BPHRSC

76 x 88 x 114 mm		1	BPHRSC

1/4" Swivel Air Connectors with Rotation Lock System



BPSJL

1/4" in		1	BPSJL



Automotive Tools



ENGINE TOOLS

Timing kit for FCA Group 1.4 Multiair engines



BE501101



68 x 225 x 280 mm

1 BE501101

BE50110101



BE50110102



BE50110103



BE50110104



Timing kit for FCA Group 0.9 petrol Twinair



BE501102



68 x 225 x 280 mm

1 BE501102

BE50110201



BE50110202



BE50110203



Timing kit for FCA Group 1.6-1.9-2.0-2.4 diesel



BE501203



68 x 225 x 280 mm

1 BE501203

BE50120301



BE50120302



BE50120303



BE50120305



BE50110103



BMW crankshaft harmonic balancer holder



BE502104

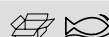

60 x 98 x 269 mm 1726 g

8 BE502104*

BMW crankshaft holding tool



BE502106



80 x 70 x 260 mm

10 BE502106*

Timing kit for FCA Group 1.3 JTD MJ



BE501204

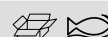

68 x 225 x 280 mm

1 BE501204

BE50120401



BE50120402



BE50120403



BE50120404



BE50120405



Timing kit for BMW 1.8-2.0 petrol

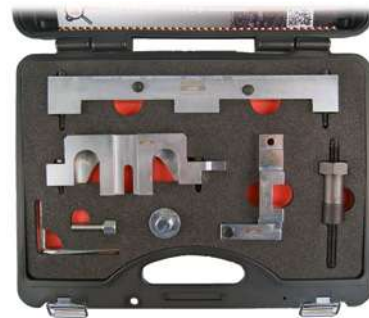

BE502101



95 x 270 x 350 mm

1 BE502101

BE50210101



BE50210102



BE50210103



BE50210104



BE50210105



BE50210106



BE50210107



Timing kit for BMW 1.6 petrol

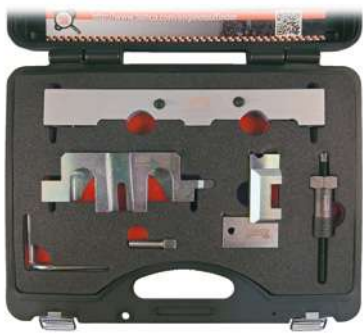

BE502102



270 x 95 x 355 mm



1 BE502102

BE50210103	
BE50210105	
BE50210107	
BE50210201	
BE50210202	
BE50210203	

Timing kit for BMW 1.6-2.0 petrol

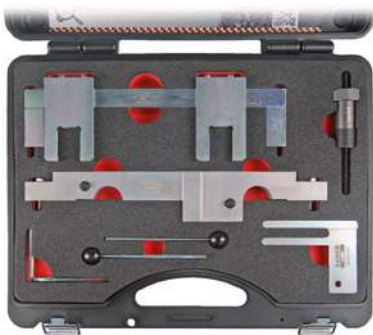

BE502103



80 x 300 x 375 mm



1 BE502103*

BE50210301	
BE50210302	
BE50210303	
BE50210305	
BE50210105	
BE50210107	

Timing kit for BMW 2.0 - 2.5 - 3.0 diesel



BE502204



68 x 225 x 280 mm



1 BE502204

BE50220401	
BE50220403	
BE50220404	
BE50220405	
BE50210305	

Timing kit for BMW Mini 1.6-2.0 diesel



BE503201



68 x 225 x 280 mm



1 BE503201

BE50320101	
BE50320102	
BE50320103	
BE50320105	
BE50210305	

Timing kit for MINI-PSA 1.4-1.6 petrol



BE504102



95 x 270 x 350 mm



1 BE504102

BE50410201	
BE50410202	
BE50410203	
BE50410204	
BE50410206	
BE50210105	

Timing kit for MINI-PSA 1.6 diesel

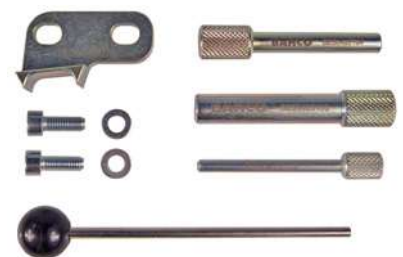

BE504201



50 x 50 x 220 mm



1 BE504201

BE50420101	
BE50420102	
BE50420103	
BE50420104	
BE50210305	

* Until stocks last



Timing kit for Ford 1.25-1.4-1.6 petrol



BE505101



68 x 225 x 280 mm



1 BE505101

BE50510101	
BE50510102	
BE50510103	
BE50510104	
BE50510105	
BE50510106	

Timing kit for Ford 1.0 EcoBoost petrol

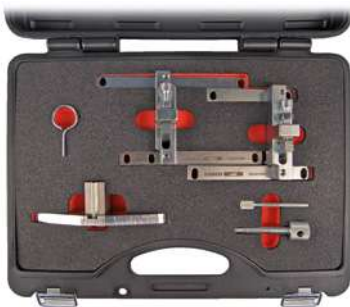

BE505102



95 x 270 x 350 mm



1 BE505102

BE50510201	
BE50510202	
BE50510203	
BE50510204	
BE50420102	
BE50510102	

Timing kit for Ford 2.0 - 2.2 - 2.4 Duratorq TDCI 16v diesel



BE505203



95 x 270 x 350 mm



1 BE505203

BE50520301	
BE50520302	
BE50520303	
BE50520304	
BE50520305	
BE50520306	
BE50520307	

Timing kit for Ford 1.4-1.6-1.8-2.0-2.2-2.5 diesel



BE505204



95 x 270 x 350 mm



1 BE505204

BE50520401	
BE50520402	
BE50520403	
BE50520404	
BE50520405	
BE50520407	
BE50520411	
BE50520412	
BE50520413	
BE50510104	
BE50420102	
BE50420103	
BE50420104	
BE50510106	

Timing kit for Opel 1.0-1.2-1.4 petrol



BE506101



50 x 50 x 160 mm



1 BE506101

BE50610101	
BE50610102	
BE50610103	
BE50610104	
BE50610105	

Timing kit for Opel 1.4-1.6-1.8 petrol



BE506102



68 x 225 x 280 mm



1 BE506102

BE50610201	
BE50610202	
BE50610203	
BE50610204	
BE50610205	
BE50610206	

Timing kit for Opel 1.0-1.2-1.4 Ecoflex petrol



BE506103

95 x 270 x 350 mm 1 BE506103

- BE50610302
- BE50610304
- BE50610102
- BE50610103
- BE50610105

Timing kit for Opel 2.0 diesel



BE506204

85 x 300 x 375 mm 1 BE506204

- BE50620401
- BE50620402
- BE50620403
- BE50620404
- BE50620405

Timing kit for PSA 1.0-1.1-1.4-1.6-1.8-2.0-2.2 petrol



BE507101

95 x 270 x 350 mm 1 BE507101

- BE50710103
- BE50710104
- BE50710105
- BE50710106
- BE50710107
- BE50710108
- BE50710109
- BE50710110
- BE50710111
- BE50710112
- BE50710101
- BE50710102
- BE50710113
- BE50710114
- BE50710116
- BE50710117
- BE50710118
- BE50710119
- BE50420104

Timing kit for PSA 1.0-1.2 petrol



BE507102

68 x 225 x 280 mm 1 BE507102

BE50710201



BE50710202



Timing kit for PSA 1.4-1.5-1.6-1.9-2.0-2.2-2.5 diesel



BE507203

85 x 300 x 375 mm 1 BE507203

- BE50720301
- BE50720302
- BE50720304
- BE50720305
- BE50720307
- BE50720308
- BE50720310
- BE50720312
- BE50720314
- BE50720317
- BE50720318
- BE50720319
- BE50720320
- BE50720321
- BE50720322
- BE50720323
- BE50520404
- BE50520411
- BE50710107
- BE50710104
- BE50710113
- BE50710110
- BE50710102
- BE50710106
- BE50420102
- BE50420103



Timing kit for Renault/Dacia 1.2-1.4-1.6-1.8-2.0 petrol

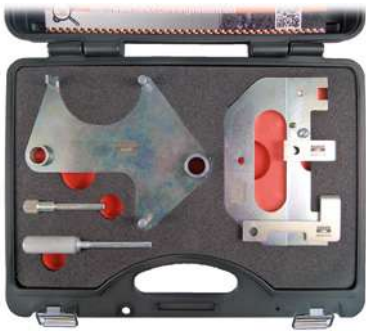

BE508101



95 x 270 x 350 mm



1 BE508101

BE50810101	
BE50810102	
BE50810103	
BE50810104	
BE50810105	
BE50810106	

Timing kit for Renault 1.5-1.9-2.2-2.5 diesel



BE508202



80 x 300 x 375 mm



1 BE508202

BE50820201	
BE50820202	
BE50820203	
BE50820204	
BE50820205	
BE50820206	
BE50820207	
BE50820208	
BE50820209	
BE50820211	
BE50810103	
BE50810104	

Timing kit for Renault 2.0 diesel



BE508203



68 x 225 x 280 mm



1 BE508203

BE50820301	
BE50820302	
BE50820303	
BE50820304	
BE50210305	

Timing set for Renault-Nissan 1.6 diesel



BE508204



95 x 270 x 350 mm



1 BE508204

BE50820402	
BE50820403	
BE50820404	
BE50820302	

Timing kit for VW Group 1.4-1.6-1.8-2.0 petrol



BE509101



80 x 300 x 375 mm



1 BE509101

BE50910101	
BE50910102	
BE50910103	
BE50910104	
BE50910105	
BE50910106	
BE50910107	
BE50910108	
BE50910109	
BE50910110	
BE50910111	
BE50910112	
BE50910114	
BE50520302	

Timing kit for VW Group 1.2-1.4-1.6 petrol



BE509102



68 x 225 x 280 mm



1 BE509102

BE50910201	
BE50910202	
BE50910203	
BE50910205	
BE50910206	
BE50910207	
BE50520302	

Timing kit for VW Group 1.2 TSI petrol



BE509103



50 x 50 x 210 mm



1 BE509103

BE50910302



BE50910203



Timing kit for VW Group 1.0 petrol



BE509104



68 x 225 x 280 mm



1 BE509104

BE50910401



BE50910402



BE50910403



BE50910404



BE50910203



Timing kit for VW Group 1.2-1.4-1.6-1.9-2.0 diesel



BE509205_1



60 x 60 x 220 mm



1 BE509205

BE50910103



BE50920602



BE50920603



Timing kit for VW Group 1.9-2.0 diesel



BE509206



60 x 60 x 220 mm



1 BE509206

BE50920602



BE50910103



BE50920703



Timing kit for VW Group 1.2-1.4-1.6-1.9-2.0 diesel

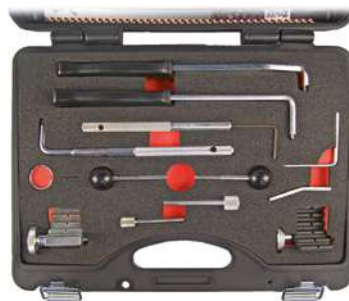

BE509207



95 x 270 x 350 mm



1 BE509207

BE50920703



BE50920707



BE50920708



BE50920709



BE50920710



BE50920711



BE50910103



BE50910112



BE50920602



BE50920603



BE50910109



BE50510102



Timing kit for Volvo 1.6 - 1.8 - 1.9 - 2.0 - 2.3 - 2.4 - 2.5 petrol



BE510101



60 x 60 x 355 mm



1 BE510101

BE51010101



BE51010102

BE51010103

Timing kit for Volvo 1.6 - 1.8 - 2.0 16v petrol



BE510102



50 x 50 x 220 mm



1 BE510102

BE51010201



BE51010202



BE50510102



BE50510105



BE50510106



Timing kit for Volvo 1.6 - 2.0 diesel



BE510203



68 x 225 x 280 mm

1 BE510203

BE50420102



BE50420103



BE50420104



BE50520407



BE50520411



BE50510104



Crankshaft pulley holding tool for Volvo



BE510304



50 x 145 x 265 mm

1 BE510304

Timing kit for Saab 1.8i petrol



BE511101



50 x 50 x 220 mm

1 BE511101

BE51110101



BE51110102



BE50610201



BE50610204



Timing kit for Saab 1.6t petrol



BE511102



50 x 50 x 207 mm

1 BE511102

BE50610201



BE50610202



BE50610205



BE50610203



Timing kit for Saab 1.9 - 2.0 - 2.2 Tid diesel



BE511203



80 x 300 x 375 mm

1 BE511203

BE51120301



BE51120302



BE51120303



BE51120304



BE51120305



BE50120302



BE50120303



BE50120305



BE50610201



Universal set for removing broken glow plugs



BE513201



95 x 270 x 350 mm 2.10 kg

1 BE513201

BE51320101



BE51320102



BE51320103



BE51320104



BE51320105



BE51320106



BE51320107



BE51320108



BE51320109



BE51320110



BE51320111



BE51320112



BE51320113



BE51320114



Sprocket holding wrench universal



BE523106



410 mm

1 BE523106

Adjustable Universal Camshaft Locking Tool



BE5100



345 x 150 x 85 mm

1 BE5100

Stretch belt installer/remover



BE230



35 x 145 x 155 mm

1 BE230

Alternator extractor 24 pcs set



BE500P24



55 x 270 x 370 mm

- 5 BE500P24
- 1 BE500P2401
- 1 BE500P2402
- 1 BE500P2403
- 1 BE500P2404
- 1 BE500P2405
- 1 BE500P2406
- 1 BE500P2407
- 1 BE500P2408



- 1 BE500P2409
- 1 BE500P2410
- 1 BE500P2411
- 1 BE500P2412
- 1 BE500P2413
- 1 BE500P2414
- 1 BE500P2415
- 1 BE500P2416
- 1 BE500P2417
- 1 BE500P2418
- 1 BE500P2419
- 1 BE500P2420
- 1 BE500P2421
- 1 BE500P2422
- 1 BE500P2423
- 1 BE500P2424

Diesel compression tester



BE5401D



105 x 325 x 410 mm

1 BE5401D

Digital petrol engine compressor tester



BE5400P



70 x 160 x 260 mm

1 BE5400P

Belt tension tester



BE239



38 x 82 x 95 mm 95 mm

1 BE239

Electronic belt tension tester



BE240



60 x 270 x 315 mm 315 mm

1 BE240

Data book of tension values for timing and accessory belts, synchronous, V&V and ribbed shape.



BE240-CAT



710 g

1 BE240-CAT



Laser thermometer



BLT550

-50 +550 °C	40 x 95 x 145 mm	10	BLT550

Quick fluid stopper and injector hose separator set



BE257

68 x 225 x 280 mm	8	BE257
	1	BE25710
	1	BE25718
	1	BE2572
	1	BE2576

Universal injector removal tool kit



BE512201

140 x 415 x 600 mm	1	BE512201

BE51220101	
BE51220102	
BE51220103	
BE51220104	
BE51220105	
BE51220106	
BE51220107	
BE51220108	
BE51220109	
BE51220110	
BE51220111	
BE51220112	
BE51220113	
BE51220114	
BE51220115	
BE51220116	
BE51220117	
BE51220118	
BE51220119	
BE51220120	

Injector puller set



BE1311P13

80 x 355 x 445 mm	1	BE1311P13

Injection nozzle socket set; 25, 27, 29 & 30 mm



BE1310P4

68 x 225 x 225 mm	1	BE1310P4*

1/2" impact socket for removing Bosch and Siemens injection nozzles



BE1310P425-BE1310P430

25 mm	1/2 in	1	BE1310P425
27 mm	1/2 in	1	BE1310P427
29 mm	1/2 in	1	BE1310P429
30 mm	1/2 in	1	BE1310P430

Diesel injector seat cleaner set



BE1320S17

76 x 266 x 355 mm	10	BE1320S17

Diesel injector seat cutter



BE1315P7

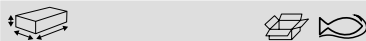

68 x 225 x 280 mm	1 BE1315P7
25 x 180 x 275 mm	1 BE1315P71
20 x 93 x 175 mm	1 BE1315P72
19 x 93 x 140 mm	1 BE1315P73
16 x 93 x 140 mm	1 BE1315P74
20 x 56 x 96 mm	1 BE1315P75
20 x 56 x 96 mm	1 BE1315P76
23 x 56 x 96 mm	1 BE1315P77

Diesel injector washer puller



BE1300

230 mm	35 x 35 x 260 mm	1 BE1300

Valve lapper set



BE762

30 x 90 x 315 mm	68 g	12 BE762

Sets of 30 washers for injectors

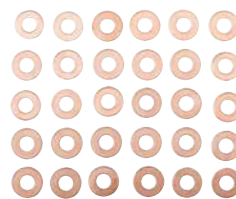

BE1305P450B



1	BE1305P450WS01
1	BE1305P450WS02
1	BE1305P450WS03
1	BE1305P450WS04
1	BE1305P450WS05
1	BE1305P450WS06
1	BE1305P450WS07
1	BE1305P450WS08
1	BE1305P450WS09
1	BE1305P450WS10
1	BE1305P450WS11
1	BE1305P450WS12
1	BE1305P450WS13
1	BE1305P450WS14
1	BE1305P450WS15

Slide hammer / Washer and wiper puller



BE1300SH

235 mm	50 x 50 x 235 mm	10 BE1300SH

Valve spring compressor removal tools



BE76101

40 x 200 x 290 mm	1 BE76101

Special Internal Valve Seat Removal Tool for Denso Common Rail Injectors



BE1312DNS

12 BE1312DNS*

Copper injector sealing ring set



BE1305P450

40 x 140 x 205 mm	1 BE1305P450*

Common rail 8 injectors fuel return tester



BE5350

84 x 341 x 447 mm	5 BE5350*
10 x 56 x 96 mm	1 BE5350C1
10 x 56 x 96 mm	1 BE5350C2
10 x 56 x 96 mm	1 BE5350C3
10 x 56 x 96 mm	1 BE5350C4
115 x 65 x 205 mm	1 BE5350C5

* Until stocks last



Diesel injector tester



BE13ZL11

480 x 230 x 280 mm	4.24 kg	1	BE13ZL11

Tamper Torx socket



BE5008-10/BE5008-45

10	1	BE5008-10*	
15	1	BE5008-15*	
20	1	BE5008-20*	
25	1	BE5008-25*	
27	1	BE5008-27*	
30	1	BE5008-30*	
40	1	BE5008-40*	
45	1	BE5008-45*	

Sets of 5 inserts/coils for repairing/restoring damaged glow plug threads



BE1210P110x

M8x1	50 g	1	BE1210P1101
M10x1	50 g	1	BE1210P1102
M10x1,25	50 g	1	BE1210P1103

1/2" diesel injection socket



7807

29 mm	80 mm	1	7807*

Glow plug socket set



BE1GP5

1/4 in	110 x 240 x 40 mm	1	BE1GP5

Glow plug chamber cleaning set



BE1200P6

50 x 115 x 260 mm	1	BE1200P6

Tamper Torx® Bit/Socket Set, 1/4"



BE5008

40 x 20 x 175 mm	1	BE5008*

BE5008-45, BE5008-27, BE5008-25, BE5008-40, BE5008-30, BE5008-10, BE5008-20, BE5008-15

Glow plug puller



BE1205

130 mm	35 x 35 x 130 mm	1	BE1205

Reamer for BE1200P6



BE1200P6AC1

50 x 158 x 192 mm	1	BE1200P6AC1

T-handle for glow plug sockets



BE1GP5-T

1/4 in	400 mm	10	BE1GP5-T

Glow plug flex sockets



BE1GP58/BE1GP514

8 mm	70 mm	1	BE1GP58
9 mm	70 mm	1	BE1GP59
10 mm	70 mm	1	BE1GP510
12 mm	70 mm	1	BE1GP512
14 mm	70 mm	1	BE1GP514

Glow plug thread repair set



BE1210P11

50 x 120 x 260 mm	1	BE1210P11
112 x 13 x 95 mm	1	BE1210P9AC1

Spark Plug Pliers



BE1P

290 mm	20 x 50 x 290 mm	1	BE1P

Spark Plug Articulated Extension Tool



BE1SP1F

30 mm	21 x 330 x 330 mm	12	BE1SP1F*

Spark plug sockets with magnet, 3/8"



7406ZZ

16 mm	65 mm	1	7406ZZ-16
21 mm	64 mm	1	7406ZZ-21

1/2" Square Drive Spark Plug Sockets



7805GPR

16 mm	64 mm	120	7805GPR-16
21 mm	64 mm	100	7805GPR-21

3/8" Square Drive Spark Plug Sockets



7402GPR

16 mm	120	7402GPR-16
18 mm	120	7402GPR-18
21 mm	100	7402GPR-21

Spark plug wrench



BE1SP

3/8 in	252 mm	10	BE1SP16L
3/8 in	252 mm	1	BE1SP14L

* Until stocks last



Spark plug wrenches



BE1T14/BE1T16/BE1T21

Ø	L	Icon	Part No.
14 mm	65/310 mm		1 BE1T14
16 mm	63/450 mm		1 BE1T16
21 mm	67/450 mm		1 BE1T21

BE110014 / Tap: M14x1.25P



BE110014/BE110015

g	Icon	Part No.
55 g		1 BE110014
55 g		1 BE110015

Insert coils for repairing spark plug threads



BE1100AC1/BE1100AC2

L	Icon	Part No.
9.4 mm		1 BE1100AC1
15 mm		1 BE1100AC2

Ribe 1/2" socket with bit, suitable for engines



BE5102

Icon	Part No.
	1 BE5102

BE51026, BE51025, BE510210, BE510211, BE510212, BE510213, BE51027, BE51028, BE51029

1/2" socket drivers with Ribe bits



BE51025-BE510213

L	Icon	Part No.
RM5	100 mm	1 BE51025
RM6	100 mm	1 BE51026
RM7	100 mm	1 BE51027
RM8	100 mm	1 BE51028
RM9	100 mm	1 BE51029
RM10	100 mm	1 BE510210
RM11	100 mm	1 BE510211
RM12	100 mm	1 BE510212
RM13	100 mm	1 BE510213

XZN 1/2" socket with bit, suitable for engines



BE5103

Icon	Part No.
	1 BE5103

BE51036, BE51038, BE510310, BE510312, BE51035, BE510314

1/2" socket drivers with XZN bits



BE51035-BE510314

Icon	L	Part No.
M5	140 mm	1 BE51035
M6	140 mm	1 BE51036
M8	140 mm	1 BE51038
M10	140 mm	1 BE510310
M12	140 mm	1 BE510312
M14	140 mm	1 BE510314

Spark plug wire brush



52

L	Icon	Part No.
150 mm		12 52

General purpose utility wire brush



782-U



285 mm



1 782-U

Milling cutter



BE110001



60 g



1 BE110001

Refractometer



3046-REF



150 mm



1 3046-REF

Terminal brush



2555



85 mm



1 2555

Piston Ring Tongs



BE74-55100/BE74-80120



55-100 mm



20 x 130 x 205 mm



1 BE74-55100

80-120 mm

20 x 145 x 220 mm

1 BE74-80120

Spark plug thread restorer set



BE1100



68 x 225 x 280 mm



1.55 kg



8 BE1100

Piston ring tightener



BE74-57125/BE74-90175



80 mm

165 mm

80 mm



57-125 mm

90-175 mm

57-125 mm



1 BE74-57125

1 BE74-90175

1 BE74-57125L

Cooling system pressure tester set



BE400P24



127 x 435 x 510 mm



1 BE400P24



Radiator pressure pump with gauge for testing cooling or heating systems



BE400P241

BAR PSI

0-2,5 bar 0-36 psi 1 BE400P241



Thermometer -50°C-150°C



BE400P244



0.02 kg



1 BE400P244

Radiator cap tester for cooling system



BE400P2403



43.5 mm



1 BE400P2403

Radiator cap test connector R124/R123



BE400P242



0.035 kg



1 BE400P242

Radiator cap tester for cooling system



BE400P2401



65 mm



1 BE400P2401

Adaptor for testing the cooling system



BE400P2404



0.055 kg



1 BE400P2404

Radiator cap test connector R123/R125



BE400P243



0.06 kg



1 BE400P243

Radiator cap tester for cooling system



BE400P2402



65 mm



1 BE400P2402

Adaptor for testing the cooling system



BE400P2405



0.065 kg



1 BE400P2405

Adaptor for testing the cooling system



BE400P2406



0.065 kg



1 BE400P2406

Adaptor for testing the cooling system



BE400P2409



0.11 kg



1 BE400P2409

Adaptor for testing the cooling system



BE400P2412



0.085 kg



1 BE400P2412

Adaptor for testing the cooling system



BE400P2407



0.065 kg



1 BE400P2407

Adaptor for testing the cooling system



BE400P2410



0.085 kg



1 BE400P2410

Adaptor for testing the cooling system



BE400P2413



0.065 kg



1 BE400P2413

Adaptor for testing the cooling system



BE400P2408



0.075 kg



1 BE400P2408

Adaptor for testing the cooling system



BE400P2411



0.11 kg



1 BE400P2411

Adaptor for testing the cooling system



BE400P2414



0.11 kg



1 BE400P2414



Adaptor for testing the cooling system



BE400P2415

0.075 kg	1	BE400P2415

Adaptor for testing the cooling system



BE400P2418

0.045 kg	1	BE400P2418

Cooling system purging and filling set



BE410

80 x 300 x 375 mm	4	BE410
45 x 45 x 105 mm	1	BE4101

Adaptor for testing the cooling system



BE400P2416

0.065 kg	1	BE400P2416

Adaptor for testing the cooling system



BE400P2419

0.075 kg	1	BE400P2419

Gasket joints separator set



BE700

90 x 200 x 43 mm	1	BE700*
	1	BE700BP2
	1	BE700SP15

Adaptor for testing the cooling system



BE400P2417

0.11 kg	1	BE400P2417

Plastic wrench for radiator cap



BE400P2420

0.005 kg	1	BE400P2420

10 mm bit set



BE5032

65 x 225 x 225 mm	1	BE5032

BE5049M5, BE5049M6, BE5049M8, BE5049M10, BE5049M12, BE5032M14		
BE5049T20, BE5049T25, BE5049T27, BE5049T30, BE5049T40, BE5049T45, BE5049T50, BE5049T55, BE5049T60		
BE5049H5, BE5049H6, BE5049H8, BE5049H10, BE5049H12, BE5032H14		
BE5032SQ8, BE5032SQ10		
BE5049H6L, BE5049H8L, BE- 5032H10EL		
BE5049T45L, BE5032T55EL		
BE5049M8L, BE5049M10L, BE5049M12L		
BE504901		

Bit for Robertson Metric Head Screws, 10 mm



BE5032SQ

#8 mm	30 mm	1	BE5032SQ8
#10 mm	30 mm	1	BE5032SQ10

1/2" socket drivers with Tamper Torx bits



BE510125-BE510160

TR25	100 mm	1	BE510125
TR27	100 mm	1	BE510127
TR30	100 mm	1	BE510130
TR40	100 mm	1	BE510140
TR45	100 mm	1	BE510145
TR50	100 mm	1	BE510150
TR55	100 mm	1	BE510155
TR60	100 mm	1	BE510160

Crankshaft and camshaft seal installation set



BE5150P27

80 x 270 x 375 mm	1	BE5150P27
56 x 56 x 96 mm	1	BE5150P271
80 x 80 x 195 mm	1	BE5150P272
170 x 160 x 385 mm	1	BE5150P273

A/C repair tool set



BE800P12

43 x 90 x 200 mm	1	BE800P12

Adaptor set for disconnection of A/C hoses



BAC007

240 mm	0.075 kg	1	BAC007

Engine support bar



BH8AC1-500

150 x 165 x 1800 mm	20.71 kg	1	BH8AC1-500

500 kg geared engine stand



BH8AC2-500

500 kg	1	BH8AC2-500

Angle hose clamp pliers 45°



BE250

190 mm	245 g	1	BE250



Hose clamp pliers



BE251A

30 x 55 x 220 mm	228 g	12	BE251A

Spare Cable for BE254A Pliers



BE254A-01

590 mm	130 g	1	BE254A-01

Hose clamp metallic



BE256M

40 x 45 x 310 mm	1	BE256M

EGR type hose clamp pliers



BE253

870 mm	1	BE253

Repair kit for BE254



BE2541

100 g	1	BE2541

Elastic hose clamp pliers



BE258

12-55 mm	285 mm	1	BE258

Standard Space Saver & Hose Clamp Ratcheting Tool



BE254A

18-53 mm	1	BE254A

Cable



BE2542

630 mm	20 g	1	BE2542

Oetiker™ Clamp Pliers



BPOC15

275 mm	12	BPOC15

Hose clamp pliers set



BE256P3

40 x 93 x 330 mm	1	BE256P3
15 x 55 x 155 mm	1	BE256-155
20 x 45 x 185 mm	1	BE256-178
10 x 55 x 250 mm	1	BE256-250

In-Line Fuel Filter Connection Pliers



BE6FCP

104 mm	218 mm	30	BE6FCP

Fuel gauge puller



BE1FTW

75-160 mm	1	BE1FTW

Slotted socket set



BE5500

10/11/12/14/17/19	25	BE5500

Fuel line disconnecting pliers set



BE1FLDS

8-10 mm	1	BE1FLDS

BE1FLD2, BE1FLD3, BE1FLD1

Fuel Filter Wrench Ford 2.2TDCi



BE1FFWF

5 x 142 x 169 mm	12	BE1FFWF

Slotted Sockets



BE5500-10/BE-5500-19

3/8 in	10	1	BE550010
3/8 in	11	1	BE550011
3/8 in	12	1	BE550012
3/8 in	14	1	BE550014
1/2 in	17	1	BE550017
1/2 in	19	1	BE550019

Fuel line disconnecting pliers



BE1FLD1/BE1FLD3

10 mm	1	BE1FLD1
8 mm	1	BE1FLD2
18.5 mm	1	BE1FLD3

Seal and soft hose removal and picking tool set



2633HD/S6

80 x 270 x 375 mm	1	2633HD/S6
42 x 93 x 290 mm	1	2633HD1
30 x 85 x 215 mm	1	2633HD2
30 x 93 x 200 mm	1	2633HD3
20 x 87 x 165 mm	1	2633HD4
10 x 60 x 120 mm	1	2633HD5
10 x 10 x 155 mm	1	2633HD6



T-Handle Set with Hex Metric Tips - 5 pcs



BE1TH-S5

Tip Size	Weight (g)	Quantity	Part Number
5 mm	60 g	10	BE1TH-5
6 mm	127 g	10	BE1TH-6
7 mm	205 g	10	BE1TH-7*
8 mm	205 g	10	BE1TH-8
9 mm	385 g	10	BE1TH-9*

Set of 6 T-Bar Handles for Allen Hex Socket Head Screws 2.5, 3, 4, 5, 6 & 8 mm



BE1TH-S6

Tip Size	Weight (g)	Quantity	Part Number
2.5 mm	15 g	10	BE1TH-2
3 mm	23 g	10	BE1TH-3
4 mm	23 g	10	BE1TH-3.5*
5 mm	60 g	10	BE1TH-4
6 mm	60 g	10	BE1TH-4.5*

BE1TH-2.5, BE1TH-3, BE1TH-4, BE1TH-8, BE1TH-6, BE1TH-5

T-bar handle for Allen - Hexagonal head screws



BE1TH

Tip Size	Weight (g)	Quantity	Part Number
10 mm	385 g	5	BE1TH-10
2 mm	15 g	10	BE1TH-2
2.5 mm	20 g	10	BE1TH-2.5
3 mm	23 g	10	BE1TH-3
3.5 mm	23 g	10	BE1TH-3.5*
4 mm	60 g	10	BE1TH-4
4.5 mm	60 g	10	BE1TH-4.5*

Tip Size	Weight (g)	Quantity	Part Number
5 mm	60 g	10	BE1TH-5
6 mm	127 g	10	BE1TH-6
7 mm	205 g	10	BE1TH-7*
8 mm	205 g	10	BE1TH-8
9 mm	385 g	10	BE1TH-9*

Set of 7 T-Bar Handles with Swivel Sockets 7, 8, 10, 12, 13, 14 & 17 mm 500 mm long



BE1TS-S7

Tip Size	Weight (g)	Quantity	Part Number
7 mm	485 g	10	BE1TS-10
8 mm	485 g	10	BE1TS-11*
10 mm	475 g	10	BE1TS-12
12 mm	485 g	10	BE1TS-13
13 mm	485 g	10	BE1TS-14
14 mm	485 g	10	BE1TS-15*
15 mm	485 g	10	BE1TS-16*
16 mm	495 g	10	BE1TS-17
17 mm	495 g	10	BE1TS-18*
18 mm	510 g	10	BE1TS-19*
19 mm	495 g	8	BE1TS-20*
20 mm	730 g	8	BE1TS-21*
21 mm	765 g	8	BE1TS-22*
22 mm	745 g	8	BE1TS-24*
24 mm	745 g	10	BE1TS-6
6 mm	475 g	10	BE1TS-7
7 mm	475 g	10	BE1TS-8
8 mm	485 g	10	BE1TS-9*

BE1TS-17, BE1TS-13, BE1TS-14, BE1TS-12, BE1TS-7, BE1TS-8, BE1TS-10

T-bar handle with swivel socket 500 mm long



BE1TS

Tip Size	Weight (g)	Quantity	Part Number
10 mm	485 g	10	BE1TS-10
11 mm	485 g	10	BE1TS-11*
12 mm	475 g	10	BE1TS-12
13 mm	485 g	10	BE1TS-13
14 mm	485 g	10	BE1TS-14
15 mm	485 g	10	BE1TS-15*
16 mm	495 g	10	BE1TS-16*
17 mm	495 g	10	BE1TS-17
18 mm	510 g	10	BE1TS-18*
19 mm	495 g	10	BE1TS-19*
20 mm	730 g	8	BE1TS-20*
21 mm	765 g	8	BE1TS-21*
22 mm	745 g	8	BE1TS-22*
24 mm	745 g	8	BE1TS-24*
6 mm	475 g	10	BE1TS-6
7 mm	475 g	10	BE1TS-7
8 mm	485 g	10	BE1TS-8
9 mm	475 g	10	BE1TS-9*

T handle bar with rotating aluminium holder



1945W

Tip Size	Length (mm)	Quantity	Part Number
1/2 in	311 mm	6	1945W12
1/4 in	311 mm	8	1945W14
3/8 in	311 mm	6	1945W38

Bit set 49 pcs with Torx tamper bits



BE5049

Dimensions	Weight (kg)	Quantity	Part Number
55 x 190 x 320 mm	3.56 kg	5	BE5049

1/2" adaptor for 10 mm bits



BE504901

Tip Size	Length (mm)	Quantity	Part Number
10 mm	36 mm	1	BE504901

Bit for Hexagon Metric Head Screws, 10 mm



BE5049H

Size	L	QTY	Part No.
4 mm	30 mm	1	BE5049H4
5 mm	30 mm	1	BE5049H5
6 mm	30 mm	1	BE5049H6
7 mm	30 mm	1	BE5049H7
8 mm	30 mm	1	BE5049H8
10 mm	30 mm	1	BE5049H10
12 mm	30 mm	1	BE5049H12
14 mm	30 mm	1	BE5032H14

Bit for XZN Head Screws, 10 mm



BE5049M

Size	L	QTY	Part No.
M5	30 mm	1	BE5049M5
M6	30 mm	1	BE5049M6
M8	30 mm	1	BE5049M8
M10	30 mm	1	BE5049M10
M12	30 mm	1	BE5049M12
M14	30 mm	1	BE5032M14

Bit for Torx® Head Screws, 10 mm



BE5049T

Size	L	QTY	Part No.
T20	30 mm	1	BE5049T20
T25	30 mm	1	BE5049T25
T27	30 mm	1	BE5049T27
T30	30 mm	1	BE5049T30
T40	30 mm	1	BE5049T40

Size	L	QTY	Part No.
T45	30 mm	1	BE5049T45
T50	30 mm	1	BE5049T50
T55	30 mm	1	BE5049T55
T60	30 mm	1	BE5049T60

Bit for Torx® Tamper Head Screws, 10 mm



BE5049T_H

Size	L	QTY	Part No.
TR20	30 mm	1	BE5049T20H
TR25	30 mm	1	BE5049T25H
TR27	30 mm	1	BE5049T27H
TR30	30 mm	1	BE5049T30H
TR40	30 mm	1	BE5049T40H
TR45	30 mm	1	BE5049T45H
TR50	30 mm	1	BE5049T50H
TR55	30 mm	1	BE5049T55H
TR60	30 mm	1	BE5049T60H

Torx® Tamper 1/2" socket with bit, suitable for engines



BE5101

Size	L	QTY	Part No.
65 x 225	225 mm	1	BE5101

BE510150, BE510145, BE510160, BE510155, BE510127, BE510125, BE510140, BE510130

Engine oil pressure tester set



BE5200

Size	L	QTY	Part No.
85 x 355 x 445 mm		1	BE5200
25 x 105 x 195 mm		1	BE530001
		1	BE52001
		1	BE52002
		1	BE52003

3/8" adaptor for 10 mm bits



BE504902

Size	L	QTY	Part No.
10 mm	28 mm	1	BE504902

Long Bit for Hexagon Metric Head Screws, 10 mm

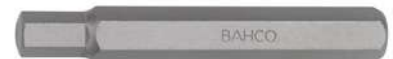

BE5049H_L

Size	L	QTY	Part No.
4 mm	75 mm	1	BE5049H4L
5 mm	75 mm	1	BE5049H5L
6 mm	75 mm	1	BE5049H6L
7 mm	75 mm	1	BE5049H7L
8 mm	75 mm	1	BE5049H8L
10 mm	75 mm	1	BE5049H10L
10 mm	115 mm	1	BE5032H10EL
12 mm	75 mm	1	BE5049H12L

* Until stocks last



Long Bit for XZN Head Screws, 10 mm



BE5049M_L

	L		
M5	75 mm	1	BE5049M5L
M6	75 mm	1	BE5049M6L
M8	75 mm	1	BE5049M8L
M10	75 mm	1	BE5049M10L
M12	75 mm	1	BE5049M12L

Bit set 49 pcs with regular Torx bits



BE5049t

	kg		
55 x 190 x 320 mm	3.54 kg	1	BE5049T

Bit for Torx® Tamper Head Screws, 10 mm



BE5049T_HL

	L		
TR20	75 mm	1	BE5049T20HL
TR25	75 mm	1	BE5049T25HL
TR27	75 mm	1	BE5049T27HL
TR30	75 mm	1	BE5049T30HL
TR40	75 mm	1	BE5049T40HL
TR45	75 mm	1	BE5049T45HL
TR50	75 mm	1	BE5049T50HL
TR55	75 mm	1	BE5049T55HL
TR60	75 mm	1	BE5049T60HL
TR70	100 mm	1	BE5049T70HL
TR80	70 mm	1	BE5049T80HL
TR30	200 mm	1	BE5049T30HXL
TR40	200 mm	1	BE5049T40HXL
TR45	200 mm	1	BE5049T45HXL

Bit for Torx® Head Screws, 10 mm

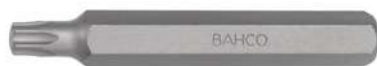

BE5049T_L

	L		
T20	75 mm	1	BE5049T20L
T25	75 mm	1	BE5049T25L
T27	75 mm	1	BE5049T27L
T30	75 mm	1	BE5049T30L
T40	75 mm	1	BE5049T40L
T45	75 mm	1	BE5049T45L
T50	75 mm	1	BE5049T50L
T55	75 mm	1	BE5049T55L
T55	115 mm	1	BE5032T55EL

EXHAUST TOOLS

Exhaust Fume Extractor



BUCPE

L			
5000 mm	1263 x 306 x 300 mm	1	BUCPE
105 mm	15 x 105 x 105 mm	1	BUCPEF1
121 mm	60 x 121 x 121 mm	1	BUCPEF

Tube extension for BUCPE



BUCPE3SH

L			
3000 mm	63,5 mm	1	BUCPE3SH

A dual exhaust pipe for BUCPE



BUCPE3SDH

	L		
420 x 530 x 3000 mm	3000 mm	1	BUCPE3SDH

1/2" Lambda service socket



7812

	L		
22 mm	78 mm	100	7812

Exhaust clamp pliers



BUC50

	L		
65 mm	305 mm	1	BUC50

Universal exhaust removal tool



BUC110

360 mm	50 x 65 x 360 mm	1	BUC110

Universal exhaust puller



BUC100

34-54 mm	320 mm	1	BUC100

OIL SERVICE TOOLS & EQUIPMENT

Fuel Filter Cover Wrench



BE6OF108

3/8 in	108 mm	50	BE6OF108

Oil & Fuel Filter Remover



BE6OFW

57-120 mm	18 x 95 x 325 mm	5	BE6OFW

Oil filter strap wrench



BE611

65-105 mm	25 x 55 x 210 mm	12	BE61110
65-105 mm	1 x 12 x 382 mm	100	BE61110-1
100-155 mm	37 x 75 x 275 mm	12	BE61155
100-155 mm	1 x 12 x 529 mm	1	BE61155-1

Oil filter strap wrench with rubber handle



BE62

65-105 mm	42.5 x 57 x 249 mm	10	BE62110
110-155 mm	42.5 x 85 x 314 mm	10	BE62155

Oil filter chain wrench



BE64520/BE64350

350 mm	60-105 mm	1	BE64350
350 mm	60-105 mm	1	BE64350CH
520 mm	60-160 mm	1	BE64520
520 mm	60-160 mm	1	BE64520CH

Rubber belt wrench



BE66152A

150 mm	95 x 170 x 220 mm	6	BE66152A

3-jaw oil filter wrench



BE65F65120

3/8 in	65-120 mm	12	BE65F65120



Magnetic 3-jaw Oil Filter Wrenches with Opening Width from 65 to 120 mm



BE65R65120

3/8-1/2 in	65-120 mm	1	BE65R65120

Magnetic 3-jaw Oil Filter Wrenches with Opening Width from 80 to 120 mm



BE65R80120

3/8-1/2 in	80-119 mm	1	BE65R80120

Magnetic 3-jaw Oil Filter Wrenches with Opening Width from 106 to 160 mm



BE65R106160

1/2 in	105-160 mm	1	BE65R106160

Oil filter cup set



BE630

87 x 505 x 610 mm	3 BE630

Individual filter cups



BE630 Parts

66 mm	Fiat, Renault	1 BE630666F
64 mm	Daihatsu, Fiat, Nissan, Toyota	12 BE6306514F
65-66 mm	Daihatsu, Toyota	12 BE630656714F
66 mm	Ford, Mazda, Subaru	1 BE6306814F
73 mm	Alfa Romeo, Lexus, Toyota	1 BE6307314F
74 mm	Audi, Chrysler, GM, Rover	1 BE6307415F
74-76 mm	Audi, Ford, Mercedes Benz, Opel, VW	12 BE630747615F
74-75 mm	Audi, Ford, Isuzu, Mercedes Benz, Opel, VW	1 BE630757715F
76 mm	Fiat, Mercedes Benz, Renault	12 BE6307612F
74 mm	Audi, BMW, Mercedes Benz, Opel, Porsche, VW	12 BE6307614F
74 mm	Ford	1 BE6307630F
74 mm	Fiat, Lancia	1 BE630768F
78 mm	Ford, Honda, Nissan, Toyota	12 BE6307815F
80 mm	Honda, Isuzu, Mazda, Nissan, Opel, Subaru, Toyota	1 BE6308015F
80-82 mm	Acura, Honda, Mazda, Nissan, Subaru, Toyota	1 BE630808215F
	Mercedes Benz, Jeep, Chrysler	12 BE6308414F
86 mm	Volvo	1 BE6308616F
86 mm	Audi, Citroen, Peugeot, Renault, VW	1 BE6308618F

89 mm	Honda, Isuzu, Mitsubishi	12 BE6309015F
92 mm	Fiat, Lancia	1 BE6309210F
92 mm	Audi, Ford, Honda, Mazda, Mitsubishi, Nissan, Opel, Porsche, Renault, Volvo, VW	1 BE6309315F
93 mm	Ford	1 BE6309336F
93 mm	Audi, VW	1 BE6309345F
95 mm	Alfa Romeo, Chrysler, Ford, Toyota	1 BE6309515F
96 mm	Audi, Renault, VW	1 BE6309618F
101 mm	Isuzu, Mitsubishi	25 BE63010015F
24 mm	BMW	50 BE630246F
106 mm	Fiat, MAN, Scania	1 BE63010615F
27 mm	Mercedes Benz	50 BE630276F
107 mm	Volvo	1 BE63010815F
32 mm	GM, Mercedes Benz, Opel, Saab	50 BE630326F
108 mm	Renault	1 BE63010818F
36 mm	BMW, Ford, Mercedes Benz, Opel, Rover, VW	100 BE630366F
38 mm	BMW, Opel, Volvo	50 BE630386F
66.5 mm	Daihatsu, Toyota	25 BE63066514F

27 mm oil filter wrench for Ford and PSA Group



BE6302712F

1/2 in	27 mm	5	BE6302712F

Oil Filter Wrench Toyota, Lexus, Subaru, Daihatsu with 4 Cylinders (1.8 to 2.0 litre)



BE63064514F1

Toyota, Lexus, Subaru, Daihatsu 4 cylinders (1.8-2.0l)	64.5 mm	1 BE63064514F1

Oil Filter Wrench Toyota, Lexus, Subaru, Daihatsu with 4, 6 or 8 Cylinders (2.5 to 5.7 litre)



BE63064514F2

64.5 mm Toyota, Lexus, Subaru, Daihatsu 4, 6, 8 cylinders (2.5-5,7L) 1 BE63064514F2

Oil Filter Cup 74 mm 14 Flutes



BE6307414F

14 1 10 BE6307414F

Carter wrenches



BE68

#	L		
8 in	265 mm	12	BE6810Z
8 in	235 mm	1	BE68
8 x 10 mm	270 mm	1	BE6810

1/4" Oil sump plug removal bit for VAG engine 2 litre 4 cylinders



BE6701VAG

10 x 50 x 125 mm 0.02 kg 1 BE6701VAG

Oil drain plug socket set



BE6217

55 x 105 x 220 mm 1 BE6217

3/8" Oil Plug Socket



BE621701-BE621717

#	mm		
6	8 mm	1	BE621701
6	9 mm	1	BE621702
6	10 mm	1	BE621703
6	12 mm	1	BE621704
6	13 mm	1	BE621705
6	14 mm	1	BE621706
6	17 mm	1	BE621707
4	8 mm	1	BE621708
4	9.5 mm	1	BE621709
4	10 mm	1	BE621710
4	10.5 mm	1	BE621711
4	11 mm	1	BE621712
4	12 mm	1	BE621713
4	13.1 mm	1	BE621714
4	10 mm	1	BE621715
3	10 mm	1	BE621716
xZN	M16 mm	1	BE621717

Oil drain plug restorer set



BOD10P64

68 x 225 x 280 mm 8 BOD10P64

Mini oil drain plug restorer sets



BOD10

#			
34 x 93 x 105 mm	1	BOD101	
35 x 95 x 105 mm	1	BOD102	
33 x 93 x 105 mm	1	BOD103	
33 x 93 x 105 mm	1	BOD104	
33 x 93 x 105 mm	1	BOD105	
95 x 105 x 35 mm	1	BOD106	

Oil drain plug and washer set



BOD10XNWS

#			
M13x1.25	1	BOD101NWS	
M13x1.5	1	BOD102NWS	
M15x1.5	1	BOD103NWS	
M17x1.5	1	BOD104NWS	
M20x1.5	1	BOD105NWS	
M22x1.5	1	BOD106NWS	



2 in 1 oil drainer with tank capacity 90L and inspection chamber



BOD8903A

1700 x 419 x 608 mm	1 BOD8903A

Gravity oil drainer with tank capacity 90L



BOD8901

1000 x 413 x 630 mm	32 kg
	1 BOD8901

Adaptor for BOD6080P12 set



BOD6080P12-11

105 g	1 BOD6080P12-11

Oil cans



BOD4200/BOD4500

0.2l	158 x 86 x 128 mm	1 BOD4200
0.5l	158 x 86 x 128 mm	1 BOD4500

2 in 1 oil drainer with tank capacity 90L



BOD8902

1000 x 413 x 632 mm	38 kg
	1 BOD8902

Extension funnel for oil drainers



BOD8901AC1

620 x 620 x 150 mm	1 BOD8901AC1

Automatic transmission fluid refiller



BOD6080P12

595 x 255 x 330 mm	1 BOD6080P12

Oil funnel



BOD301200

225 x 165 x 165 mm	1 BOD301200

Oil drain tank



BOD2008

8 l	115 x 325 x 590 mm	1	BOD2008

2L Can with Flexible Spout



BOD2FS

2 l	330 x 130 x 380 mm	20	BOD2FS

Heavy duty cartridge grease pump



BOD5HD400

60 x 115 x 360 mm	1 BOD5HD400

Oil drain pan



BOD1016

16 l	170 x 450 x 570 mm	1	BOD1016

Rotary barrel pump



BOD70

230 x 250 x 1330 mm	1 BOD70

Cartridge grease pump



BOD5400/BOD5450

55 x 120 x 390 mm	1 BOD5400
65 x 125 x 385 mm	1 BOD5450

For tapping damaged oil plug thread slightly oversize, then fitting a new drain plug and washer



BOD10XT

92 mm	M13x1.25	1	BOD101T
70 mm	M13x1.5	1	BOD102T
70 mm	M15x1.5	1	BOD103T
70 mm	M17x1.5	1	BOD104T
70 mm	M20x1.5	1	BOD105T
70 mm	M22x1.5	1	BOD106T

Lever Action Barrel Pump



BOD60

875 x 57 x 245 mm	1 BOD60

BAHCO BRAKE SYSTEM TOOLS & EQUIPMENT

Brake fluid tester pen



BBR100

20 x 20 x 150 mm	1 BBR100



Brake fluid tester moisture check



BBR110



35 x 65 x 160 mm



1 BBR110

Brake Nipple Spanners



BBR501011-50121314



10 / 11 mm
12 / 14 mm



3/8 in
3/8 in



50 BBR501011
50 BBR50121314*

Air brake system bleeder



BBR350



1/4" in 300 x 125 x 125 mm



1 BBR350

12V Electrical Brake Bleeder



BBRBB12



895 x 390 x 395 mm



14.6 kg



1 BBRBB12

Brake bleeder master cylinder cap adapter kit



Brake Bleeder Master Cylinder Cap Adapter Kit Contents



BBRAS14-01/BBRAS14-14



PN5 in	Universal	1	BBRAS14-01
PN5 in	Honda	1	BBRAS14-02
PN5 in	Honda Accord	1	BBRAS14-03
PN5 in	Universal	1	BBRAS14-04
PN5 in	Chrysler, Jeep, Plymouth	1	BBRAS14-05
PN5 in	Chrysler, Jeep, Plymouth, Dodge	1	BBRAS14-06
PN5 in	Nissan	1	BBRAS14-07
PN5 in	Alfa Romeo, Fiat, Peugeot, Citroën, Audi, BMW, Jaguar, Land-Rover, Mercedes, Porsche, Renault, Saab, VW, Volvo, Chrysler, Daewoo, Ford, Kia, Mazda, Mini, etc	1	BBRAS14-08
PN5 in	Hyundai, Mitsubishi, Nissan, Subaru, Chrysler, Dodge, Ford, etc.	1	BBRAS14-09
PN5 in	GM Models and Mazda	1	BBRAS14-10
PN5 in	Toyota and Lexus	1	BBRAS14-11
N/A in	Holder for universal adaptor	1	BBRAS14-12
N/A in	Syringe	1	BBRAS14-13
N/A in	Hooks, chains and roulettes for BBRAS14-01 and BBRAS14-04	1	BBRAS14-14

Brake pad thickness gauge



BBRPTG1



68 g



10 BBRPTG1

Micrometer with magnetic base



1154



230 x 50 x 75 mm



1 1154

1154-DG



1154-MB



Dial indicator



1154-DG



0-10 mm



0.01 mm



1 1154-DG

Magnetic base holder



1154-MB



70 x 96 x 297 mm



230 + 150 mm



1 1154-MB

Aluminium caliper



BBR400



6 x 89 x 120 mm



1 BBR400

Digital caliper for brake discs



BBR420



0-60 mm



35 x 104 x 176 mm



50 BBR420

Digital Brake Caliper



BBR405



460 mm



20 BBR405

Brake brush, steel



783



223 mm



1 783

Caliper for measuring brake disc and brake shoe diameters



Caliper for measuring brake disc and brake shoe diameters



BBR410



20 x 210 x 280 mm



0.610 kg



24 BBR410

Brake caliper wind-back air tool



BBR320



3/8 in



1/4" in



1 BBR320

* Until stocks last



Universal brake caliper tool set 50 pieces



BBR300P50



82 x 350 x 425 mm 5.56 kg 4 BBR300P50

T30		78 mm	1	BBR203P930
T40		78 mm	1	BBR203P940
T45		78 mm	1	BBR203P945
T50		78 mm	1	BBR203P950
T55		78 mm	1	BBR203P955
T60		78 mm	1	BBR203P960

XZN 1/2" impact socket bit set for brakes



BBR201P6



68 x 225 x 225 mm 8 BBR201P6

BBR201P67814, BBR201P67816, BBR201P67818, BBR201P64018, BBR201P64014, BBR201P64016

1/2 impact socket driver XZN



BBR201P64014-BB201P67818



M14		40 mm	1	BBR201P64014
M16		40 mm	1	BBR201P64016
M18		40 mm	1	BBR201P64018
M14		78 mm	1	BBR201P67814
M16		78 mm	1	BBR201P67816
M18		78 mm	1	BBR201P67818

1/2" impact socket drivers with Torx bits for brakes



BBR203P920-BBR203P960



T20		78 mm	1	BBR203P920
T25		78 mm	1	BBR203P925
T27		78 mm	1	BBR203P927

1/2" pentagon socket and bit set for hand brake



BBR202P4



43 x 90 x 200 mm
 1 BBR202P4
 1 BBR202P410
 1 BBR202P414
 1 BBR202P419
 1 BBR202P455

Shoe brake springs removal and installation set



BBR210P3



80 x 270 x 375 mm
 25 x 59 x 182 mm
 75 x 270 x 350 mm
 1 BBR210P3
 1 BBR210P*
 1 BBR210P2

Brake spring pliers with pivoting head



BBR6135



335 mm 1 BBR6135

Brake spring pliers



BBR6131



210 mm



1 BBR6131

Hand Brake Cable Pliers



BBR204



235 mm



21,9 mm



6 BBR204

Brake Circuit Clamps



BBR150i



13.5 mm



10 x 52 x 165 mm



24 BBR150i

Flaring Kit



BBRFKM1



141 x 115 x 195 mm



1551 g



12 BBRFKM1*

TRANSMISSION & WHEEL TOOLS

Wheel wrenches



29-B/BWXW1/BWXW2



17,19,21 mm

1/2 in

1 29-B

17,19,22 mm

1/2 in

1 BWXW1

24,27,32 mm

3/4 in

4 BWXW2

17, 19, 21, 22 mm

1 BWXW3

24, 27, 32, 38 mm

1 BWXW4

17, 19 and 21 mm impact wheel socket set



BWSS12P3



17, 19, 21 mm 45 x 125 x 145 mm



20 BWSS12P3

BWSS12P317, BWSS12P319, BWS-S12P321

17, 19, 21, 22 and 24 mm impact wheel socket set



BWSS12P5



17, 19, 21, 22, 24 mm 175 x 240 x 50 mm



1 BWSS12P5

BWSS12P319, BWSS12P317, BWSS12P524, BWSS12P522, BWS-S12P321

Wheel socket sets



BWSS12P



1/2 in

17 mm

1 BWSS12P317

1/2 in

19 mm

1 BWSS12P319

1/2 in

21 mm

1 BWSS12P321

1/2 in

22 mm

1 BWSS12P522

1/2 in

24 mm

1 BWSS12P524

15 mm impact wheel socket



BWSMB15



15 mm



25 BWSMB15

* Until stocks last



17 mm impact socket for Mercedes anti-theft wheel nut



BWSMB17



17 mm

1 BWSMB17

21 mm anti-theft impact socket for Hyundai and KIA



BWSHK21



1/2" in

21 mm

25 BWSHK21

17, 19 and 21 mm long reach impact wheel socket set



BWSS12P3L



17, 19, 21 mm 68 x 225 x 225 mm

1 BWSS12P3L

BWSS12P317L, BWSS12P319L, BWSS12P321L



1/2" long reach impact wheel socket



BWSS12PL



1/2 in

17 mm

1 BWSS12P317L

1/2 in

19 mm

1 BWSS12P319L

1/2 in

21 mm

1 BWSS12P321L*

Long twist socket set 1/2" 17, 19 and 21 mm



BWTSP3L



68 x 225 x 150 mm

1 BWTSP3L

BWTSP317L, BWTSP319L, BWTSP321L

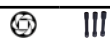

Twist socket set 1/2" 17, 19, 21, 22, 24 mm



BWTSP6



55 x 105 x 217 mm

1 BWTSP6

BWTSP619, BWTSP617, BWTSP622, BWTSP621, BWTSP624



Deep Twist Sockets



BWTSP617-BWTSP624



17 mm

1/2 in

1 BWTSP617

19 mm

1/2 in

1 BWTSP619

21 mm

1/2 in

1 BWTSP621

22 mm

1/2 in

1 BWTSP622

24 mm

1/2 in

1 BWTSP624

17, 19 and 21 mm long reach impact wheel socket set



Deep 1/2" Twist Sockets 150 mm long



BWTS317L-BWTSP321L



1/2 in

17 mm

1 BWTS317L

1/2 in

19 mm

1 BWTSP319L

1/2 in

21 mm

1 BWTSP321L

Twist socket set



BWTSP7



52 x 117 x 207 mm

1 BWTSP7

1/2": 22, 24, 27, 32 mm & 3/4": 36, 41 mm

Twist socket sets



BWTSP16

48 x 125 x 245 mm	1	BWTSP16

3/8": 8, 10, 11, 12, 13, 14, 16, 17, 18, 19 mm & 1/2": 21, 22, 24, 27 mm

Twist socket



BWTSP

8 mm	3/8 in	1	BWTSP1608
10 mm	3/8 in	1	BWTSP1610
11 mm	3/8 in	1	BWTSP1611
12 mm	3/8 in	1	BWTSP1612
13 mm	3/8 in	1	BWTSP1613
14 mm	3/8 in	1	BWTSP1614
16 mm	3/8 in	1	BWTSP1616
17 mm	3/8 in	1	BWTSP1617
18 mm	3/8 in	1	BWTSP1618
19 mm	3/8 in	1	BWTSP1619
21 mm	1/2 in	1	BWTSP1621
22 mm	1/2 in	1	BWTSP1622
24 mm	1/2 in	1	BWTSP1624
27 mm	1/2 in	1	BWTSP1627
32 mm	1/2 in	1	BWTSP732
36 mm	3/4 in	1	BWTSP736
41 mm	3/4 in	1	BWTSP741

Set of 5 torsion bars with 1/2" drive designed for tightening wheel nuts with an impact wrench without exceeding the recommended torque



BWTB12P5

68 x 225 x 280 mm	1.74 kg	1	BWTB12P5

BWTB12P90, BWTB12P100, BWTB12P110, BWTB12P120, BWTB12P135

Torsion bars with 1/2" drive designed for tightening wheel nuts with an impact wrench without exceeding the recommended torque



BWTB12P90-BWTB12P200

	Nm		
200 mm	100 N-m	1	BWTB12P100
200 mm	110 N-m	1	BWTB12P110
200 mm	120 N-m	1	BWTB12P120
200 mm	135 N-m	1	BWTB12P135
200 mm	150 N-m	1	BWTB12P150
200 mm	160 N-m	1	BWTB12P160
200 mm	175 N-m	1	BWTB12P175
200 mm	190 N-m	1	BWTB12P190
200 mm	200 N-m	1	BWTB12P200
200 mm	90 N-m	1	BWTB12P90

1" impact torsion bars



BZWTB

32 mm	450 N-m	1	BZWTB0132450*
32 mm	600 N-m	1	BZWTB0132600*

Wheel bolt bag



BWBB

0.023 kg	180 x 1 x 300 mm	200	BWBB

Thread Tapping Set



BWHTRS12

225 x 67 x 225 mm	1350 g	15	BWHTRS12*

* Until stocks last



Tyre lever



38-8 - 38-24

L	Icons	Quantity	Part No.
200 mm		5	38-8
300 mm		5	38-12
400 mm		5	38-16
500 mm		2	38-20
600 mm		1	38-24

Tyre levers



38A

L	Icons	Quantity	Part No.
200 mm		25	38A-08
240 mm		25	38A-10
304 mm		1	38A-12
382 mm		25	38A-15
537 mm		1	38A-21
655 mm		1	38A-26

Tyre lever for commercial vehicles and trucks



38C

L	Icons	Quantity	Part No.
645 mm		1	38C-26

Tyre lever, special bent form



39-24

L	Icons	Quantity	Part No.
605 mm		1	39-24

Wheel Chocks



BWC1

Dimensions	Icons	Quantity	Part No.
75 x 77 x 110 mm		25	BWC1

Wheel balancing pliers



BWP150

Dimensions	Icons	Quantity	Part No.
20 x 87 x 255 mm		1	BWP150

Digital tyre tread depth gauge



BWTDG1

Scale	Dimensions	Quantity	Part No.
0 - 25 mm	30 x 76 x 156 mm	50	BWTDG1

Tyre pressure gauge



BWTPG1

Dimensions	Icons	Quantity	Part No.
20 x 90 x 394 mm		10	BWTPG1*

Tire Pressure Monitoring System Maintenance Tool Set



BWTPMSS9

Dimensions	Weight	Icons	Quantity	Part No.
68 x 225 x 225 mm	1049 g		8	BWTPMSS9

Tire valve core tool with 0.45 Nm max torque



BWTVCTT355

Torque	Dimensions	Icons	Quantity	Part No.
0.45 N·m	30 x 76 x 156 mm		1	BWTVCTT355

Tyre Nozzle Deflation Caps



BWTPMSS4C



27 x 59 x 108 mm 60 g 25 BWTPMSS4C

3/4" heavy vehicle impact sockets Scania, Volvo



BHVIS08

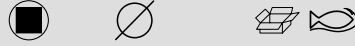

3/4 in	95 mm	1	BHVIS0895
3/4 in	100 mm	1	BHVIS08100
3/4 in	115 mm	1	BHVIS08115
	109 mm	1	BHVIS109BPW12
	120 mm	1	BHVIS120BPW16

Wheel hub plate with slide hammer and hydraulic spindle



BWHEPSSH8

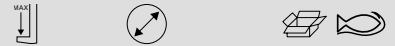

12 to #4-5/116-135 mm 1 BWHEPSSH8

1/2" impact socket and bit set



BT15P5



60 x 85 x 255 mm 1 BT15P5

1" thin wall impact sockets



BHVIS12 / BHVIS06

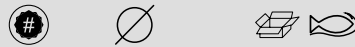

12	68 mm	1	BHVIS1265
6	70 mm	1	BHVIS0670
6	77 mm	1	BHVIS0677
6	80 mm	1	BHVIS0680
6	85 mm	1	BHVIS0685
6	90 mm	1	BHVIS0690
6	95 mm	1	BHVIS0695
6	100 mm	1	BHVIS06100
6	105 mm	1	BHVIS06105

Wheel hub hydraulic puller



BWHEPS

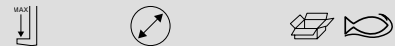

12 to #4-5 / 116-135 mm 1 BWHEPS

BWHEP

BWHEHS

1/2" impact socket with bihex profile



BT15P524-BT15P536

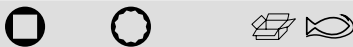

1/2 in	24 mm	1	BT15P524
1/2 in	30 mm	1	BT15P530
1/2 in	32 mm	1	BT15P532
1/2 in	36 mm	1	BT15P536

3/4" Square Drive Special Impact Socket for BPW Axles



BHVISxxBPW

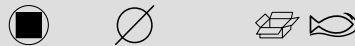

3/4 in	111 mm	1	BHVIS111BPW12
3/4 in	80 mm	1	BHVIS80BPW12
3/4 in	95 mm	1	BHVIS95BPW9

Set of wheel hub plate and slide hammer



BWHEPSH8



#4-5 / 116-135 mm 960 x 150 x 150 mm 1 BWHEPSH8

* Until stocks last



Wheel hub plate



BWHEP

#4-5 / 116-135 mm	90 x 147 x 147 mm	1 BWHEP

Slide hammer, 8 kg



BWSH8

960 x 100 x 100 mm	1 BWSH8

BWSH5	
BWSH51	
BSSHE3	

3.5 kg mass



BSSHE3

60 mm	100 mm	1 BSSHE3

12 T hydraulic spindle



BWHEHS

12 to	265-282 mm	1 BWHEHS

Steering Arm Inner Tie Rod Removal Tool Cages



BS5228-BS523945

28-34 mm	1 BS5228341
34-40 mm	1 BS5234401
39-35 mm	1 BS5239451

5 kg slide hammer



BWSH5

100 x 100 x 985 mm	2 BWSH5

M18 adaptor



BWSH51

M38 mm	M18x38	1 BWSH51

Stainless strap and buckles



BE2512005

5 mm	12 m
	1 BE2512005

5 kg slide hammer



BWSH5

100 x 100 x 985 mm	2 BWSH5

Stainless steel strap pliers



BE251200

170 mm	1 BE251200

CV boot installation pneumatic tool



BPCVB1

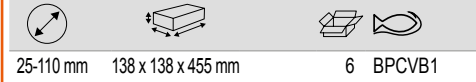

25-110 mm 138 x 138 x 455 mm 6 BPCVB1

Stainless strap and buckles



BE2512008



8 mm 15 m 1 BE2512008

Steering Arm Inner Tie Rod Removal Tool Set.



BS52

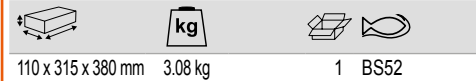

110 x 315 x 380 mm 3.08 kg 1 BS52

Axle joint tool



BS54



57 x 57 x 70 mm 1 BS54

Tie Rod End Extractor



BS56

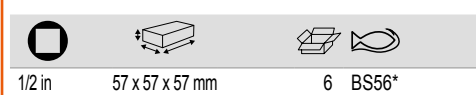

1/2 in 57 x 57 x 57 mm 6 BS56*

Rear Axle Eccentric Socket



BS45BMW

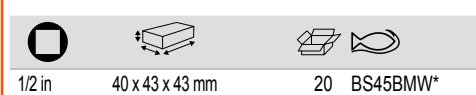

1/2 in 40 x 43 x 43 mm 20 BS45BMW*

Camber Adjusting Tool



BS40VAG



22 mm 52 x 92 x 150 mm 20 BS40VAG

Wheel Bearing Tool Set



BWB14

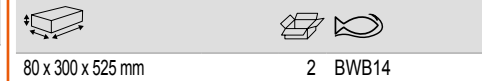

80 x 300 x 525 mm 2 BWB14

Bearing removal and installation set



BT20P26

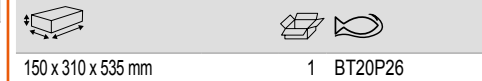

150 x 310 x 535 mm 1 BT20P26

* Until stocks last



Hydraulic Bearing Removal and Installation Set



BT20P49

164 x 520 x 890 mm	1 BT20P49

VW T4 Supporting Joint Tool



4594VWT4

245 x 112 x 320 mm	5 4594VWT4*

Centring Mandrels Set for SAC Clutches



BE301CM-SET

26 x 81.5 x 200 mm	50 BE301CM

BE301CM-01, BE301CM-02

Ball joint fork puller



BS6

18 mm	400 mm	1 BS618
23 mm	400 mm	1 BS623

Ball joint socket puller for PSA



BS100PSA1

56 mm	52 mm	1 BS100PSA1

Centring Mandrels for SAC Clutches



BE301CM

15.19 mm	174 mm	20 BE301CM-01
20.26 mm	174 mm	20 BE301CM-02

Ball joint extractor set with 12T hydraulic spindle



BWHPJ12

12 to	70 mm	4 BWHPJ12

SAC Clutch Tool Set



BE301

80 x 395 x 430 mm	2 BE301

Clutch alignment rectifier



BE310

68 x 225 x 280 mm	1.14 kg	8 BE310

SUSPENSION TOOLS & EQUIPMENT

Suspension arm lever bar



BS25

20 N·m	200 kg	1	BS25

MacPherson spring compressor



BS15

125 x 425 x 510 mm	1 BS15

Double Pneumatic Piston Shock Absorber Compressor with Protective Screen



BS30PG

1180 x 500 x 625 mm	24 kN	1	BS30PG

Universal Shock Absorber Blocking System



BS10AC2

400 x 400 x 200 mm	1 kg	1	BS10AC2

Moving height extension



BS30AC1

336 x 545 x 450 mm	1 BS30AC1

Turnbuckle shock absorber



BS1000

70 x 405 x 575 mm	1 BS1000 1 BS100001 1 BS100002



- 1 BS100003
- 1 BS100004
- 1 BS100005
- 1 BS100006
- 1 BS100007
- 1 BS100008
- 1 BS100009
- 1 BS100010
- 1 BS100011
- 1 BS100012
- 1 BS100013
- 1 BS100014
- 1 BS100015
- 1 BS100016
- 1 BS100017
- 1 BS100018
- 1 BS100019
- 1 BS100020
- 1 BS100021
- 1 BS100022
- 1 BS100023
- 1 BS100024
- 1 BS100025
- 1 BS100026
- 1 BS100027
- 1 BS100028
- 1 BS100029
- 1 BS100030
- 1 BS100031
- 1 BS100032
- 1 BS100033
- 1 BS100034
- 1 BS100035
- 1 BS100036
- 1 BS100037
- 1 BS100038
- 1 BS100039

BATTERY MANAGEMENT & ELECTRICAL TOOLS

On Board Diagnostic Memory Saver Detector



BELMS12OBDL

40 x 70 x 140 mm	8 BELMS12OBDL



Booster 12V 1200 CA



BBAGM12-1200

V	CA		
12 V	1200 A	1	BBAGM12-1200

Automatic electronic booster chargers



BBAGMCHG

70 x 105 x 130 mm	1 BBAGMCHG

Jumper leads



BBJL

16 mm ²	3 m	5 BBJL1630
25 mm ²	3.5 m	1 BBJL2535
35 mm ²	4.5 m	1 BBJL3545

Booster 12/24V 2400 / 1200 CA



BBAGM1224-2400

V	CA		
12 / 24 V	2400 / 1200 A	1	BBAGM1224-2400

Spare Booster 12V Charging Cable



BBAGMCAB

	V	
25 x 80 x 200 mm	12 V	1 BBAGMCAB

3 Amp Fully Automatic Charger/Maintainer for 12V Lead-acid and Lithium LiFeP04 Batteries



BBCE12-3

V	A		
12 V	3 A	2	BBCE12-3

Spare battery for 12V boosters



BBAGMBAT

V		
12 V	25 A·h	1 BBAGMBAT

12V/24V Heavy Duty Booster



BBA1224-3200

V	CA		
12/24 V	3200/1600 A	1	BBA1224-3200

6 Amp Fully Automatic Charger/Maintainer for 12V Batteries



BBCE12-6

V	A		
12 V	6 A	2	BBCE12-6

10 Amp Fully Automatic Charger/
Maintainer for 12V Batteries



BBCE12-10



12V 10A 2 BBCE12-10

15 Amp Fully Automatic Charger/
Maintainer for 12V Batteries with Supply
Mode



BBCE12-15S



12V 10/15A 2 BBCE12-15S

10 Amp Fully Automatic Charger/
Maintainer for 24V Batteries



BBCE24-10



24V 10A 2 BBCE24-10

100A Battery Charger/Power Supply



BBCE12-F100



12V 4/20/70/100AA 1 BBCE12-F100

Mobile charger/starter



BBC420-BBC620



230V 20/1000 A-h 1 BBC420
230V 20/1550 A-h 1 BBC620

Hydrometer battery tester



BB10



50 x 50 x 285 mm 1 BB10

12V digital battery tester



BBT20



90 x 160 x 345 mm 1 BBT20

12V Digital Battery Tester



BBT60A



27 x 95 x 135 mm 36 BBT60A

6V & 12V Digital Battery Tester with Printer



BBT80



64 x 130 x 251 mm 6 BBT80



Digital multimeter, autoranging, true RMS 1000V, with port for connection to PC



BMMTRMS1

155 x 60 x 225 mm	0.8 kg	1	BMMTRMS1

IR & RF key tester



BELTKEY

35 x 63 x 160 mm	1	BELTKEY*

24V Vehicle Lamps Operation Plug Socket Tester



BELT2415A

40 x 138 x 205 mm	1.897 kg	20	BELT2415A

1000V Voltage Absence Tester, Non-Contact Voltage Tester



BMVAT1000

310 x 50 x 100 mm	0.302 kg	50	BMVAT1000

Socket tester 7 pin 12V



BELT127

35 x 63 x 160 mm	1	BELT127*

Socket tester 7 Pin 24V (24N)



BELT247N

55 x 63 x 160 mm	1	BELT247N

1000A AC/DC True RMS Digital Clamp Meter



BDACM1000

60 x 143 x 250 mm	0.551 kg	30	BDACM1000

12V Vehicle Lamps Operation Plug Socket Tester



BELT1213A

40 x 138 x 205 mm	1.726 kg	1	BELT1213A

Socket tester 7 pin 24V (24S)



BELT247S

35 x 63 x 155 mm	1	BELT247S

Professional gas soldering iron



BGIS125

25-125 W	46 x 88 x 295 mm	20	BGIS125

Memory saver 12V



BELS12

35 x 63 x 160 mm	1	BELS12

Ring connectors (quick connect) for BBCE612-2, BBCE12-3 and BBCE12-6 chargers



BBCER1

100 g	1	BBCER1

Terminal set 16 pcs



BELTRP16

58 x 215 x 265 mm	1	BELTRP16
	1	BELTRP1601
	1	BELTRP1602
	1	BELTRP1603
	1	BELTRP1604
	1	BELTRP1605
	1	BELTRP1606
	1	BELTRP1607
	1	BELTRP1608
	1	BELTRP1609
	1	BELTRP1610
	1	BELTRP1611
	1	BELTRP1612
	1	BELTRP1613
	1	BELTRP1614
	1	BELTRP1615
	1	BELTRP1616

12V/24V peak protector



BELP1224

35 x 63 x 160 mm	1	BELP1224

Battery Clamps (quick connect) for Battery Clamps (quick connect) for BBCE12-10 and BBCE24-10 chargers



BBCEC2

68 g	1	BBCEC2

Battery clamps (quick connect) for BBCE612-2, BBCE12-3 and BBCE12-6 chargers



BBCEC1

68 g	1	BBCEC1

Ring connectors (quick connect) for BBCE12-10 and BBCE24-10 chargers



BBCER2

100 g	1	BBCER2



Booster charger cables - spares



BBBCAB



50 x 125 x 50 mm
50 x 125 x 50 mm
50 x 50 x 50 mm

1 BBBCAB-AUZ
1 BBBCAB-EU
1 BBBCAB-UK

PRESSES & ACCESSORIES

Bench Press, 15 Tonne



BH715



15.000 kg

1 BH715

Press, 20T, 30T and 50T

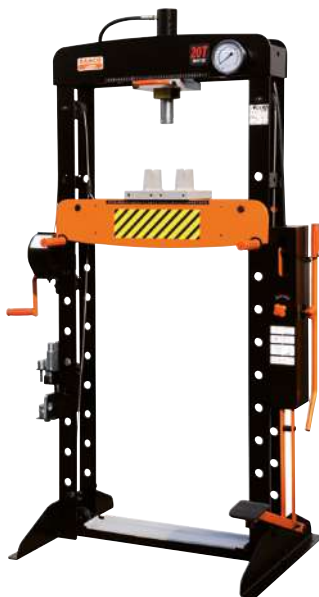

BH720/BH730/BH750



20.000 kg
30.000 kg
50.000 kg

1 BH720
1 BH730
1 BH750

Hydro-pneumatic press 100T



BH7100



100000 kg

1 BH7100A

Universal Press Supports 30 t



BH7PS30



225 x 100 x 275 mm

2 BH7PS30

Press pins set for presses



BH715-13



7.09 kg
7.09 kg

1 BH715-13
1 BH720-22

Safety grids for presses 20, 30 and 50T

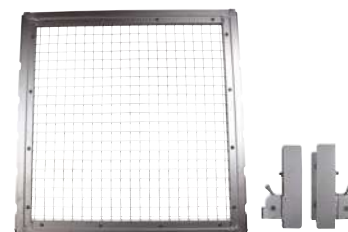

BH7_SG



530 mm
590 mm
625 mm

20 mm
20 mm
20 mm

1 BH720SG
1 BH730SG
1 BH750SG

Safety grid for press 100ton



BH7100SG



150 x 593 x 625 mm

5.54 kg

1 BH7100SG

GENERAL AUTOMOTIVE TOOLS AND EQUIPMENT

Multi-Purpose Tables



BLEMAT1



860 x 155 x 780 mm

28.7 kg

1 BLEMAT1*

Multi-Purpose Table Bottom Trays



BLEMAT1BT



50 x 760 x 890 mm

10.5 kg

1 BLEMAT1BT*

Set of 4 Storage/Protection Bags for
Wheels and Tyres



BWB1418S4/BWB1922S4



355 - 470 mm

6 BWB1418S4

470 - 560 mm

6 BWB1922S4*

Rectangular magnetic tray



BMR240



250 mm

1 BMR240

Magnetic dish



1419-MD



150 mm

1 1419-MD

Pneumatic stool



BLE305



430 x 410 x 430 mm

1 BLE305

Round magnetic dish



BMD150



160 mm

1 BMD150

Pneumatic stool



BLE300



380 x 380 x 550 mm

136 kg

1 BLE300

* Until stocks last



Creeper and stool combo



BLE302

135 x 490 x 1010 mm	136 kg	1	BLE302

Low profile creeper



BLE301

120 x 590 x 1020 mm	136 kg	1	BLE301

Creeper and stool set



BLE304

460 x 1020 x 135 mm	116 / 100 kg	1	BLE304

Seat cover



5750

1390 mm	1 5750

Multipurpose Vehicle Front Body Protector



5770

350 x 300 x 85 mm	990 g	12	5770

Car panel protector



BBS50

900 mm	1.2 mm	1	BBS50

Dual Laser Headlamp Tester



BLBT100

1650 x 500 x 565 mm	1 BLBT100

Rail track for BLBT100



BLBT100AC1

150 x 150 x 1025 mm	7.77 kg	1	BLBT100AC1

Multi-position ratcheting pry bar set



BT10P3

80 x 270 x 375 mm	1 BT10P3

Multi Position Prybar



BT10P325-BT10P338



250 mm	40	BT10P325
300 mm	1	BT10P330
380 mm	1	BT10P338

Long Pry Bar Set with Rubber Grip



BPBLS4



78 x 255 x 1000 mm	9050 g	2	BPBLS4
--------------------	--------	---	--------

BPBL00900, BPBL30900, BPBL70600, BPBL90600

Long Pry Bars with Rubber Grip



BPBL



930 mm	5	BPBL00900*
925 mm	5	BPBL30900
610 mm	5	BPBL70600*
628 mm	5	BPBL90600*

BODY SHOP TOOLS

Universal holder with rubber vacuum pads



BBS3BH1



955 mm	1	BBS3BH1
--------	---	---------

Vacuum Pad for Universal Holder



BBS3BH1-VP



60 x 95 x 95 mm	40	BBS3BH1-VP
-----------------	----	------------

Holder for bodywork shop



BBS3UH



950 x 800 x 1200 mm	20 kg	1	BBS3UH
---------------------	-------	---	--------

Rubber suction cup



BBS075



160 mm	175 mm	12	BBS075
--------	--------	----	--------

Two double suction cups and belt



BBS150



120 mm	400 mm	1	BBS150
--------	--------	---	--------

Glass run channel cleaner



BBS106



25 x 25 x 332 mm	0.145 kg	1	BBS106
------------------	----------	---	--------

Wire starter



BBS103



25 x 25 x 345 mm	1	BBS103
------------------	---	--------

* Until stocks last



T-handle wire pushing tool



BBS102



265 mm

1 BBS102

Wire grip handle set



BBS101



30 x 80 x 115 mm

1 BBS101

Windscreen cut-out wires



BBS150S



50 m
50 m
50 m

1 BBS150R
1 BBS150S
1 BBS150T

Windscreen cut-out tool



BBS105



20 x 90 x 200 mm

1 BBS105

Urethane cutting knife



BBS10450



10 x 30 x 450 mm 0.240 kg

1 BBS10450

Blades for windscreen cut-out tool



BBS107



1 x 18 x 125 mm

1 BBS107

Blades for windscreen cut-out tool



BBS108



20 x 19 x 88 mm

1 BBS108

WIPER ARM PULLER SET



BBS165



117 x 25 x 78 mm

10 BBS165

Wiper puller set



BBS170P13



80 x 275 x 375 mm

1 BBS170P13
1 BBS170P131
1 BBS170P132



- 1 BBS170P133
- 1 BBS170P134
- 1 BBS170P135
- 1 BBS170P136
- 1 BBS170P137
- 1 BBS170P138
- 1 BBS170P139
- 50 BBS165SP4

Bodywork pein & finishing hammer



BBSH2C



40 mm



1 BBSH2C

Bodywork bumping hammer



BBSH3CF



40 mm



37 mm



6 BBSH3CF

12 kg slide hammer



BBS12SH



800 mm



12 kg



1 BBS12SH

Bodywork angled pein & finishing hammer



BBSH2CA



40 mm



12 BBSH2CA

Bodywork shop light bumping hammer



BBSH3CF30



30 mm



25 mm



6 BBSH3CF30

Bodywork dressing hammer



BBSH1F



50x30 mm



1 BBSH1F

Bodywork pick & finishing hammer



BBSH2CP



40 mm



6 BBSH2CP

Bodywork light shrinking hammer



BBSH3FS



37 mm



40 mm



6 BBSH3FS

Bodywork dressing hammer



BBSH1M



50x30 mm



1 BBSH1M

Bodywork pein & finishing hammer



BBSH2F



40 mm



6 BBSH2F

Bodywork shrinking hammer



BBSH3MF



30 mm



27 mm



1 BBSH3MF



Spare handle for BBSH hammers



BBSHWH1



160 g



1 BBSHWH1

Bodywork heel dolly



BBSDH



30 x 60 x 79 mm



1 BBSDH

Bodywork single spoon



BBSS1



25 x 56 x 390 mm



1 BBSS1

Bodywork American dolly



BBSDA



30 x 63 x 83 mm



1 BBSDA

Bodywork toe dolly



BBSDT



26 x 58 x 120 mm



6 BBSDT

Bodywork double spoon short



BBSS2



150 x 60 x 410 mm



8 BBSS2

Bodywork comma dolly



BBSDC



40 x 58 x 128 mm



6 BBSDC

Bodywork wedge dolly



BBSDW



25 x 64 x 112 mm



6 BBSDW

Bodywork double spoon long



BBSS2L



175 x 60 x 520 mm



2.3 kg



1 BBSS2L

Bodywork diablo dolly



BBSDD



55 x 55 x 55 mm



1 BBSDD

Rubber heel dolly



BBSDHR



40 x 62 x 75 mm



1 BBSDHR

Trim pad remover



2485



240 mm



1 2485

Trip pud removal pliers



BBS200



65 x 75 x 250 mm



1 BBS200

Trim remover



BBS20P12



35 x 355 x 585 mm



1 BBS20P12

Plastic repair set



BBS210



100 x 280 x 360 mm
 22 x 64 x 106 mm
 22 x 64 x 106 mm
 22 x 64 x 106 mm
 22 x 64 x 106 mm
 22 x 64 x 106 mm
 22 x 64 x 106 mm
 22 x 64 x 106 mm
 22 x 64 x 106 mm



1 BBS210
 1 BBS210U06
 1 BBS210U08
 1 BBS210UA06
 1 BBS210UA08
 1 BBS210V06
 1 BBS210V08
 1 BBS210W06
 1 BBS210W08

Airbag removal tool set 12 pcs



BBS100



55 x 160 x 275 mm



1 BBS100
 1 BBS10001
 1 BBS10002
 1 BBS10003
 1 BBS10004
 1 BBS10005
 1 BBS100057
 1 BBS10006
 1 BBS10007
 1 BBS10008
 1 BBS10009
 1 BBS10010

Bodywork scraper set, 4 pcs



2220



125 g



1 22209004B

Nut riveter



1468-M6



20 x 110 x 265 mm



1 1468-M6

Nut riveter



1468-M10



50 x 210 x 575 mm



6 1468-M10

1468-M6 nut riveter inserts



1468-6M



15 x 15 x 50 mm
 13 x 13 x 50 mm
 25 x 25 x 55 mm
 20 x 20 x 55 mm



1 1468-6M3
 1 1468-6M4
 1 1468-6M5
 1 1468-6M6

1468-M10 Nut Riveter inserts



1468-10M



17 x 17 x 90 mm
 17 x 17 x 90 mm
 20 x 20 x 90 mm
 20 x 20 x 85 mm
 20 x 20 x 85 mm



1 1468-10M4
 1 1468-10M5
 1 1468-10M6
 1 1468-10M8
 1 1468-10M10



Portable ram sets 4T and 10T



BH8PR

Icon	kg	Icon	Icon
	31 kg		1 BH8PR10000
	18.65 kg		1 BH8PR4000

Body clamps



BH8BC1

Icon	Icon	Icon	Icon
	45 x 135 x 230 mm		1 BH8BC1

Body clamps



BH8BC2

Icon	Icon	Icon	Icon
	51 x 150 x 220 mm		1 BH8BC2

Body clamps



BH8BC3

Icon	Icon	Icon	Icon
	90 x 65 x 240 mm		10 BH8BC3

Body clamps



BH8BC4

Icon	Icon	Icon	Icon
	80 x 120 x 175 mm		6 BH8BC4

Body clamps



BH8BC5

Icon	Icon	Icon	Icon
	45 x 155 x 230 mm		6 BH8BC5

LIFTING EQUIPMENT

Premium Hydraulic Bottle Jacks



BH4B

Icon	Icon	Icon	Icon
	195 x 115 x 135 mm		10 BH4B2
5000 kg	220 x 115 x 155 mm		6 BH4B5
8000 kg	220 x 120 x 175 mm		4 BH4B8
12000 kg	260 x 145 x 200 mm		2 BH4B12
20000 kg	290 x 180 x 230 mm		2 BH4B20
30000 kg	335 x 160 x 240 mm		1 BH4B30

Hydraulic Bottle Jacks



BH4G

Icon	Icon	Icon	Icon
	200 x 105 x 105 mm		6 BH4G2
2000 kg	215 x 110 x 125 mm		6 BH4G4
4000 kg	230 x 120 x 130 mm		4 BH4G6
6000 kg	245 x 130 x 140 mm		4 BH4G8
8000 kg	240 x 140 x 150 mm		4 BH4G12
12000 kg	245 x 155 x 175 mm		2 BH4G20
20000 kg	290 x 200 x 225 mm		1 BH4G50
50000 kg			

Air Hydraulic Welded Bottle Jacks



BH4HP50

50000 kg	300 x 210 x 310 mm	1	BH4HP50

1.5 T Aluminium Trolley Jack



BH1A1500A

1500 kg	170 x 370 x 660 mm	1	BH1A1500A

2.5 T Aluminium Trolley Jack



BH1A2500A

2500 kg	205 x 385 x 800 mm	1	BH1A2500A

Trolley jack, 3T



BH1EU3000

3000 kg	1400 x 340 x 617 mm	1	BH1EU3000

Extra low entry, extra long reach



BH11500

1500 kg	1270 x 364 x 945 mm	1	BH11500

Extra low entry



BH12000

2000 kg	1270 x 364 x 780 mm	1	BH12000

Trolley jack 3T



BH13000

3000 kg	1280 x 364 x 825 mm	1	BH13000

3T trolley jack with Quick Approach



BH13000QA

3000 kg	220 x 395 x 900 mm	1	BH13000QA



Cross beam adaptor, 1 T



BH1CB1000

1000 kg	145 x 125 x 710 mm	1	BH1CB1000

10T Extra Long Trolley Jack



BH110000B

10000 kg	270 x 520 x 1670 mm	1	BH110000B

Spare rubber saddle



BH1RS

BH1EU3000		1	BH1EU3000-03
BH11500, BH12000, BH13000, BH13000QA, BH13000L, BH1M1000, BH1A2500A		1	BH11500-04
BH15000A		1	BH15000A-04
BH110000A		1	BH110000A-04

3T long chassis high elevation trolley jack



BH13000L

3000 kg	1310 x 530 x 1370 mm	1	BH13000L

120 mm extensions for jacks ref. BH15000A and ref. BH110000A



BH15000A-EXT/BH110000A-EXT

151 mm		1	BH110000A-EXT*

Spare front wheels for jacks



BH1_FW

BH1A2500		1	BH1A2500-03
BH13000		1	BH13000-02
BH1EU3000		1	BH1EU3000-01
BH1M1000, BH11500, BH12000		1	BH11500-02
BH1S45		1	BH1S45-03
BH15000A		1	BH15000A-02
BH110000A		1	BH110000A-02

Extra Long Trolley Jack, 5T



BH15000B

5000 kg	330 x 520 x 1670 mm	1	BH15000B

Scissor jack, 4T - 5T



BH1S45

4000 kg	1194 x 212 x 680 mm	1	BH1S45

2 step balloon jacks



BH9BJ22SSH

2000 kg	345 x 265 x 265 mm	1	BH9BJ22SSH

2 step balloon jacks



BH9BJ22

2000 kg	1000 x 265 x 265 mm	1	BH9BJ22SLH

Extensions for pneumatic stage jacks



BH9BJ260_80

970 g 1180 g	1	BH9BJ260 BH9BJ280

Air-hydraulic jack 30T/15T



BH23015

30000 kg	1250 x 282 x 810 mm	1	BH23015

3 step balloon jacks



BH9BJ23SSH

2000 kg	490 x 250 x 250 mm	1	BH9BJ23SSH

Air hydraulic jack, 30T



BH230

360 mm 627 mm	1	BH230	

Extra low entry air-hydraulic



BH2402010

40000 kg	1225 x 302 x 825 mm	1	BH2402010

3 step balloon jacks



BH9BJ23

2000 kg	1000 x 250 x 250 mm	1	BH9BJ23SLH

Compact air hydraulic jack, 15T - 30T



BH23015C

30000 kg	1350 x 290 x 430 mm	1	BH23015C

Air-hydraulic



BH2604020

60000 kg	1250 x 295 x 875 mm	1	BH2604020



Air Hydraulic Jacks 80/50T



BH28050

80000 kg	380 x 470 x 1200 mm	1 BH28050

Jack stands (pair)



BH33000/BH36000

3000 kg 6000 kg	1 BH33000 1 BH36000

Heavy duty jack stand



BH3HD8000

8000 kg	2 BH3HD8000

Heavy duty saddles

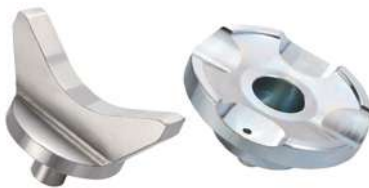

BH2AC60

78 x 70 x 110 mm	0.97 kg	1 BH2AC60V110*

Auto-rising jack stands



BH3A

3000 kg 5000 kg 10000 kg	1 BH3A3000 1 BH3A5000 1 BH3A10000

Heavy duty jack stand



BH3HD12000

12000 kg	1 BH3HD12000

Pair of aluminium of jack stands, 2,500kg capacity



BH3AL2500

2500 kg	1 BH3AL2500*

Square base jack stand



BH3SQ

7000 kg 15000 kg	2 BH3SQ7000 2 BH3SQ15000

Heavy duty jack stand



BH3HD16000

16000 kg	1 BH3HD16000

20T Heavy Duty Jack Stand



BH3HD20000A

20000 kg		1	BH3HD20000A

Hydraulic transmission jack single piston
500kg capacity



BH5SP500QA

500 kg	2041 x 660 x 660 mm	1	BH5SP500QA

Hydraulic transmission jack double piston
1000kg capacity



BH5DP1000QA

1000 kg	1954 x 759 x 759 mm	1	BH5DP1000QA

Universal saddle for transmission jacks



BH5US1000

250 x 340 x 420 mm	260-510 mm	1	BH5US1000

Car dolly for vehicle manoeuvring



BH1CD680

16.22 kg	610 x 240 x 220 mm	1	BH1CD680

Storage rack for car dollies



BH1CD680ST

715 x 130 x 155 mm	135 kg	1	BH1CD680ST

Hydraulic Wheel Dolly 600kg capacity



BH8AC3-600

1030 x 1050 x 1020 mm	93.5 kg	1	BH8AC3-600

Hydraulic Wheel Dolly, 1.5T



BH8AC3-1500A

310 x 1070 x 1345 mm	132 kg	1	BH8AC3-1500A

Foldable europallet crane, 600 kg



BH6PC600

2315 x 1040 x 1480 mm	96 kg	1	BH6PC600



* Until stocks last



Foldable crane 1T



BH6FC1000

 2175 x 1030 x 1480 mm 85 kg 1 BH6FC1000

Hydraulic ISO VG15 oil spare can 250 ml



BHVG15-250







 160 x 60 x 60 mm 220 g 1 BHVG15-250

Foldable crane, 2T



BH6FC2000







 2640 x 1220 x 1845 mm 170 kg 1 BH6FC2000

Spare rear wheels for jacks



BH1_RW

 BH1A1500 1 BH1A1500-04
 BH1A2500 1 BH1A2500-04
 BH1M1000,BH11500,BH12000,
 BH13000 1 BH11500-01
 BH1EU3000 1 BH1EU3000-08
 BH13000L 1 BH13000L-01
 BH1S45-01 1 BH1S45-01
 BH15000A,BH110000A 1 BH15000A-01

Engine Hoist Load Balancer



BH6AC1-680A



 565 x 12 x 774 mm 1 BH6AC1-680A



Lighting Equipment



HAND LIGHTS

Pocket Lamps with Torch



BLTS7P

45 lm	58	BLTS7P

Aluminium Flex Work Lights with Torch



BLTFC1

180 lm	20	BLTFC1

Slim Lights with Torch



BLTS10

400 lm	20	BLTS10

HEAD LIGHTS

Head Lights with Elastic Strap



BFRL11

260 lm	1	BFRL11

CABLE REELS

2-Phase 230 VAC Cable Reels without Lamp



BLCR230

230 V	800/2000 W	1	BLCR230FR
230 V	800/2000 W	1	BLCR230SC

3-Phase 400 VAC Cable Reels without Lamp



BLCR400E

400 V	2800/5000 W	1	BLCR400E

Speed Control Adaptors for Cable Reels



BLCRSC

BLCR		
230PL,FR,SC	76 x 91 x 117 mm	1 BLCRSC1
24VCL,VLL	76 x 91 x 117 mm	1 BLCRSC2



Inspection Tools



ENDOSCOPES

Fibre Optic Lens Cables for Endoscopes



BE200C

Ø	L	Icons	Part No.
25 mm	10 m	1	BE200CAB250SH10*
25 mm	25 m	1	BE200CAB250SH25
25 mm	3 m	1	BE200CAB250SH3*
4 mm	1 m	1	BE200CAB40F1*
5.5 mm	1 m	1	BE200CAB55F1*
5.5 mm	3 m	1	BE200CAB55F3*
5.8 mm	1 m	1	BE200CAB58SR1
5.8 mm	3 m	1	BE200CAB58SR3
8 mm	1 m	1	BE200CAB80SR1
8 mm	3 m	1	BE200CAB80SR3

Mirrored and Magnetic Tips for Endoscopes



BE200M

°	Icons	Part No.
0°	5.5, 5.8	1 BE200MAG55
35°	5.5, 5.8	1 BE200MIR5535
45°	5.5, 5.8	1 BE200MIR5545
55°	5.5, 5.8	1 BE200MIR5555
35°	8	1 BE200MIR8035
45°	8	1 BE200MIR8045
55°	8	1 BE200MIR8055
35°	4	1 BE200MIR4035
55°	4	1 BE200MIR4055

STETHOSCOPES

Garage Stethoscope Set



BE220

Icons	kg	Icons	Part No.
130 x 370 x 340 mm	2.94 kg	1	BE220

Stethoscopes with Steel Probe



5050

Icons	Part No.
1050 mm	1 5050

MIRRORS

Magnifying Swivel Head Mirrors



5515GV

Icons	Part No.
215 mm 30 mm	1 5515GV

Telescopic Swivel Head Mirrors 52 mm



5515T-52

Icons	Part No.
255-450 mm 52 mm	25 5515T-52

Pivoting Inspection Mirror with LED and Insulated Semi-rigid Cable



5515FL

Icons	Part No.
550 mm 62 x 38 mm	10 5515FL

Pivoting Inspection Mirror with UV and Insulated Semi-rigid Cable



5515FUV

Icons	Part No.
550 m 65x42 mm	1 5515FUV

Plastic Repair Mirrors



5515B

Icons	Part No.
220 mm 28.5 mm	25 5515B

Repair Mirrors with Metal Handle 30 mm



5515M

210 mm	30 mm	1	5515M

Swivel Head Telescopic Pocket Mirrors



5515T

180-690 mm	30 mm	25	5515T

Magnifying Small and Light Mirrors 18 mm



5515L

160 mm	21 mm	1	5515L

MAGNIFIERS

Optical Magnifier



BOM10X

180 mm	10	BOM10X

* Until stocks last





BAHCO®



Extractors & Pullers



MECHANICAL

2-Arm Universal Pullers with Induction Hardened Spindle and Galvanized Finish



4532

25-80 mm	100 mm	1			4532-A
25-80 mm	200 mm	1			4532-AL
25-130 mm	100 mm	1			4532-B
25-130 mm	200 mm	1			4532-BL
50-160 mm	150 mm	1			4532-C
50-160 mm	300 mm	1			4532-CL
60-200 mm	150 mm	1			4532-D
80-250 mm	200 mm	1			4532-E
80-350 mm	200 mm	1			4532-F
110-520 mm	200 mm	1			4532-G
110-520 mm	300 mm	1			4532-G-SO
170-640 mm	225 mm	1			4532-H

4532/B: Spare body 4532K: Pair of spare arms 4532LK: Pair of long spare arms 4532/S: Spare spindles

Pair of Spare Arm for 4532 Extractor



4532K-4532LK

4532-A, 4532-B	100 mm	1			4532K1
4532-C, 4532-D	150 mm	1			4532K2
4532-E, 4532-F, 4532-G	200 mm	1			4532K3
4532-H	225 mm	1			4532K4
4532-AL, 4532-BL	200 mm	1			4532LK1
4532-CL	300 mm	1			4532LK2
4532-G-SO	300 mm	1			4532LK3
4532-E, 4532-F, 4532-G, 4532-G-SO	400 mm	1			4532LK4
4532-E, 4532-F, 4532-G, 4532-G-SO	500 mm	1			4532LK5

Spindle for 4532 Puller



4532-S

4532-O, 4532-A, 4532-AL, 4532-B, 4532-BL	1				4532-OAB/S
4532-C, 4532-CL, 4532-D	1				4532-CD/S
4532-E, 4532-F, 4532-G, 4532-G-SO	1				4532-EFG/S
4532-H	1				4532-H/S

2-Arm Universal Pullers with Galvanized Finish



4532-0

20-90 mm	100 mm	1			4532-0

4532-0/B: Spare body 4532K0: Pair of spare arms

2-Arm Universal Pullers with Long Arms/ Spindle and Galvanized Finish



3115

80-250 mm	300 mm	1			3115

2-Arm Universal Puller Set Displays with Galvanized Finish



4532ST/5

16700 g	1				4532ST/5

4532-A, 4532-B, 4532-C, 4532-D, 4532-E

3-Leg and Multi Arm Pullers



4533

150-700 mm	185 mm	1			4533HP
150-700 mm	200 mm	1			4533M
	185 mm	1			4533HPK
	200 mm	1			4533MK
		1			4533HP/S
		1			4533M/S

4533HP: hydraulic 4533M: mechanical 4533/S: Spare spindle 4533/K: Set of 3 spare arms

Hydraulic Rams with Galvanized Finish



4529

8 to 15 to	T_n max				
	60 N·m	1			4529-8
	70 N·m	1			4529-15

3-Arm Hydraulic Extractors



4528

50-350 mm	135 mm	1	4528-1

4528K: Set of 3 spare arms 4528/B: Spare body 4533HP/S: Spare hydraulic spindle

2-Arm Heavy Duty Pullers with Galvanized Finish



4544

10-100 mm	80 mm	1	4544-1
10-120 mm	120 mm	1	4544-2
20-160 mm	160 mm	1	4544-3
20-200 mm	200 mm	1	4544-4
		1	4544-110/S
		1	4544-220/S
		1	4519-1/S
		1	4544-440/S

4544-1/4:w/2 arms 4544-10/30:w/3 arms 4544/B: spare body 4544K: spare arm 4544/S: spare spindle

3-Arm Heavy Duty Pullers with Galvanized Finish



4544-

10-100 mm	80 mm	1	4544-10
10-120 mm	120 mm	1	4544-20
20-160 mm	160 mm	1	4544-30

2-Arm Heavy Duty Pullers with Galvanized Finish



4543

10-60 mm	40 mm	1	4543-1
10-70 mm	74 mm	1	4543-2
10-90 mm	84 mm	1	4543-3
		1	4543-1/S
		1	4543-2/S
		1	4543-3/S

4543-1/3:w/2 arms 4543-10/30:w/3 arms 4543/B: Spare body 4543K: Spare arm 4543/S: Spare spindle

3-Arm Light Duty Pullers with Galvanized Finish



4543-

10-60 mm	40 mm	1	4543-10
10-70 mm	74 mm	1	4543-20
10-90 mm	84 mm	1	4543-30

2-Arm Pullers with Galvanized Finish



4541

20-150 mm	85 mm	1	4541-A
40-220 mm	130 mm	1	4541-B

4541/B: Spare body 4541K: Spare arm 4532-4519/S: Spare spindle

3-Arm Pullers with Galvanized Finish



4542

20-150 mm	85 mm	1	4542-A
40-220 mm	130 mm	1	4542-B

4542/B: Spare body 4541K: Spare arm 4532-4519/S: Spare spindle

2-Arm Puller with Galvanized Finish



4537

20-170 mm	130 mm	1	4537-1
20-230 mm	200 mm	1	4537-2
50-300 mm	250 mm	1	4537-3
50-350 mm	350 mm	1	4537-4

4537/B: Spare body 4537K: Spare arm 4532-4519/S: Spare spindle

3-Arm Pullers for 4528M1/4528M2/4528M3 Extractors



4528M

20-170 mm	130 mm	1	4528M1
20-230 mm	200 mm	1	4528M2
50-300 mm	250 mm	1	4528M3
50-350 mm	350 mm	1	4528M4
50-400 mm	400 mm	1	4528M5

4528M/B: Spare body 4537K-4528MK: Spare arm 4532/S-4519/S: Spare spindle



2-Arm Pullers with Clamp and Galvanized Finish



4519

20-110 mm	80-170 mm	1	4519-1
40-150 mm	90-270 mm	1	4519-2
40-150 mm	90-330 mm	1	4519-3

4519/B: spare body 4519K: spare arm 4519/S: spare spindle

Scissor-Type Pullers with Galvanized Finish



4614

6-100 mm	70-85 mm	1	4614-1
10-140 mm	85-120 mm	1	4614-2

4614/B: spare body 4614K: pair of spare arms 4543-4532/S: spare spindle

Multiple Extractors



4540

30-170 mm	65-140 mm	1	4540-17
		1	4540-17/S
75-250 mm	77-180 mm	1	4540-25
		1	4540-25/S

Extractors for Separators



4552

4551-A-B	1	4552-1	
4551-C	1	4552-2	
4551-D	1	4552-3	

4552/B: Spare body 4552K: Spare tie rod 4532/S: Spare spindle

Separators with Galvanized Finish



4551

4552-1	1	4551-A	
4552-1	1	4551-B	
4552-2	1	4551-C	
4552-3	1	4551-D	

4551/S: spare spindle

Pullers and Separator Set with Galvanized Finish



4574

105 x 300 x 360 mm	1	4574	

4532-A, 4532-C

4532LK1, 4532LK2

4551-C

4529-15

Ball Bearing Extractors without Arms



4581N-4583N

4581NA, 4581NB	1	4581N-1	
4581NB2, 4581NC, 4582NA	1	4582N-1	
4581NC, 4582NA, 4582NB	1	4582N-2	
4582NA, 4583NA	1	4583N-1	
4582NA, 4582NB, 4583NB	1	4583N-2	

Extractors Spare Arms Set



4581NA-4583NB

145 mm	4581N-1	1	4581NA
120 mm	4581N-1	1	4581NB
130 mm	4582N-1	1	4581NB2
130 mm	4582N-1, 4582N-2	1	4581NC
150 mm	4582N-1, 4582N-2, 4583N-1, 4583N-2	1	4582NA
150 mm	4582N-2, 4583N-2	1	4582NB
190 mm	4583N-1	1	4583NA
235 mm	4583N-2	1	4583NB

Ball Bearing Puller Set with Galvanized Finish



4580N/7

66 x 192 x 287 mm	1	4580N/7	

4581N-1, 4582N-1, 4582N-2, 4583N-1, 4583N-2, 4581NA to 4583NB

Ball Bearing Extractor Set with Galvanized Finish



4578

75 x 235 x 285 mm	1 4578

4581N-1, 4582N-2, 4581NA, 4581NB, 4581NB2, 4581NC

Ball Bearing Internal Extractors with Gunmetal Finish



4521N

5-7 mm	1 4521N-00
7-9 mm	1 4521N-0
9-12 mm	1 4521N-A
10-13 mm	1 4521N-B
13-17 mm	1 4521N-C
14-19 mm	1 4521N-D
16-21 mm	1 4521N-E
18-23 mm	1 4521N-F
20-25 mm	1 4521N-G
25-30 mm	1 4521N-H
30-37 mm	1 4521N-I
35-42 mm	1 4521N-K
38-45 mm	1 4521N-L
43-50 mm	1 4521N-M
40-75 mm	1 4521N-S
70-115 mm	1 4521N-T

2-Arm Counter Stay Extractors with Galvanized Finish



4522

35-75 mm	1 4522-1
60-130 mm	1 4522-2

4522/B: Spare body 4522/K: Spare arm 4522/S: Spare spindle

Sliding Hammer Pulling Bars with Gunmetal Finish



4523G

Ø10x170 mm	1 4523G

Sliding Hammer Pulling Bars with Galvanized Finish



4524G

Ø16 x 250 mm	1 4524G

Complete Workshop Puller Assortment Set - 9 Pcs



4521N/7

95 x 360 x 310 mm	6800 g	1 4521N/7

4521N-B, 4521N-D, 4521N-H, 4521N-I, 4521N-L, 4521N-S, 4521N-G

4522-2, 4522-1

Universal Ball Joint Pullers with Galvanized Finish



4545-N

Max 50 mm	18-22 mm	1 4545-N1
Max 90 mm	27-36 mm	1 4545-N11
Max 50 mm	26 mm	1 4545-N2
60-80 mm	26 mm	1 4545-N21

4545/S: Spare spindle

Universal Hub Pullers with Galvanized Finish



4518

225 mm	140 mm	1 4518-3
225 mm	140 mm	1 4518-4
225 mm	140 mm	1 4518-5



Ball Joint Extractors with Galvanized Finish



4545

18 mm	1	4545-1
25 mm	1	4545-2
29 mm	1	4545-3
40 mm	1	4545-4
45 mm	1	4545-5

Extractors Set for Car Maintenance



4577

70 x 340 x 425 mm	1	4577

4545-N2	
4532-B	
4614-1	
4521N-D, 4521N-B, 4521N-H, 4521N-I, 4521N-G, 4521N-L	
4522-1	

Internal and External Extractor with Sliding Hammer Set



4590SHS5

79 x 230 x 500 mm	4	4590SHS5

Mini Puller Set with Galvanized Finish



4579

65 x 210 x 275 mm	1	4579

4543-2, 4543-3, 4543-1020/B, 4543-30/B, 4543K220, 4543K330

Hydraulic Nut Splitters with Galvanized and Gunmetal Finish



4610

M4-M14	1	4610-1

Mechanical Nut Splitters with Galvanised and Gunmetal Finish



4611

to M16	1	4611-2
to M24	1	4611-3

4611/S: spare spindles 4611/B: spare blades

Stud Removers with Chromed Plated



4553

5-20 mm	1	4553

Stud Removers with Galvanised and Gunmetal Finish



4591-4593

10-19 mm	1	4592
5-15 mm	1	4591
18-28 mm	1	4593

Stud Extractors Rolled Thread



1420-1424

M 3-6	1	1420-1.4
M 6-8	1	1421-2.1
M 8-11	1	1422-3.1
M11-14	1	1423-4.8
M14-18	1	1424-6.2

Stud Extractors - 5 Pcs



1435/5

15 x 50 x 90 mm	110 g	1 1435/5

1423-4.8, 1420-1.4, 1422-3.1, 1421-2.1, 1424-6.2

Stud Extractors - 8 Pcs



1435/8

29 x 110 x 118 mm	700 g	1 1435/8

1420-1.4, 1421-2.1, 1422-3.1, 1423-4.8, 1424-6.2

Stud Extractors for Broken-Off Screws/
Bolts/Studs M5-M24



1419-M5/1419-M16

M5-M10	1	1419-M5
M8-M14	1	1419-M8
M12-M20	1	1419-M12
M16-M24	1	1419-M16

Stud Extractor Set for Broken-Off Screws/
Bolts/Studs - 4 Pcs



1419/4

M5-M24	430 g	1 1419/4

M5-M10; M8-M14; M12-M20; M16-M24

Multi Spline Extractors Set - 15 Pcs



BWMSP15

43 x 90 x 200 mm	0.54 kg	1 BWMSP15

Stud Extraction Bits with Blasted Finish



BWMSP15

3 mm	13 mm	1	BWMSP1501
4 mm	13 mm	1	BWMSP1502
5 mm	13 mm	1	BWMSP1503
5.5 mm	13 mm	1	BWMSP1504
6 mm	13 mm	1	BWMSP1505
8 mm	13 mm	1	BWMSP1506
10 mm	13 mm	1	BWMSP1507
1/8 in	13 mm	1	BWMSP1508
3/16 in	13 mm	1	BWMSP1509
1/4 in	13 mm	1	BWMSP1510
3/8 in	13 mm	1	BWMSP1511
11 mm	16 mm	1	BWMSP1512
12 mm	16 mm	1	BWMSP1513
14 mm	16 mm	1	BWMSP1514
1/2 in	16 mm	1	BWMSP1515

Stud Extractors for Broken-Off Screws/
Bolts/Studs M5-M16



1418S

25 x 127 x 162 mm	M6-M16	1 1418S

1418-4, 1418-5, 1418-6, 1418-7.5, 1418-8.5



Stud Extractors with Alloy Steel



1418

M5-M8	1	1418-4
M8-M10	1	1418-5
D11-M12	1	1418-6
M12-M14	1	1418-7.5
M14-M16	1	1418-8.5

Flat Head Pinch Bars with Flat Shank



3680

400 mm	1	3680

Flat Head Pry Bar with Through Blade for Hammering



2484T-20/2484T-60

210 mm	1	2484T-20
312 mm	1	2484T-30
450 mm	1	2484T-45
600 mm	1	2484T-60

PRY BARS

Combination Pinch Bars with Hexagon Shank



2632

170 mm	1	2632

Flat Head Pry Bars with PP Handle



2484-20/2484-60

205 mm	1	2484-20
305 mm	1	2484-30
465 mm	1	2484-45
615 mm	1	2484-60

4 pcs Flat Head Pry Bars with Through Blade for Hammering



2484T/S4

42 x 145 x 693 mm	1950 g	1	2484T/S4

Flat Head Pinch Bars with Hexagon Shank



3684

406 mm	1	3684-16
457 mm	1	3684-18
609 mm	1	3684-24
760 mm	1	3684-30

Flat Head Pry Bar Set with PP Handle



2484/S4

42 x 145 x 693 mm	10	2484/S4

Rolling Head Pry Bar



3683

400 mm	1	3683

2484-20, 2484-30, 2484-45, 2484-60

Rolling Head Pry Bars with Phosphated Body



3681

L	Icon	Quantity	Part No.
304 mm		1	3681-11
406 mm		1	3681-16
503 mm		1	3681-20

PICKING TOOLS

ERGO™ Neodymium Magnetic Pick-Up Tool 4 mm x 290 mm



ergo

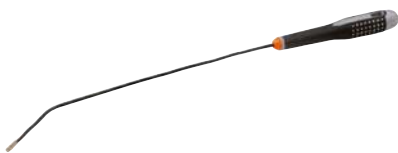

2535F0

Icon	Icon	Icon	Quantity	Part No.
			1	2535F0

BahcoFit Flexible Magnetic Pullers with Rubber Grip 10-18 mm



B147

Icon	Icon	Icon	Quantity	Part No.
			1	B147.001.400
			1	B147.003.400

Magnetic pick-up ERGO™



ergo



2535F

Icon	Icon	Icon	Quantity	Part No.
			1	2535F1
			1	2535F2
			1	2535F3

Magnetic pick-up tool with light



2535L

Icon	Icon	Icon	Quantity	Part No.
			12	2535L

Flexible Pick-Up Tools with Steel Core



2509

L	Icon	Quantity	Part No.
555 mm		50	2509

Claw Pick-Up Tools with Steel Core



2530

L	Icon	Quantity	Part No.
605 mm		1	2530

THREAD TOOLS

Thread Cutting Toolset - 37 Pcs



1460M/1

Icon	Icon	Icon	Quantity	Part No.
			1	1460M/1

Thread Cutting Toolset - 55 Pcs



1460M/2

Icon	Icon	Icon	Quantity	Part No.
			1	1460M/2

Thread Cutting Toolset - 54 Pcs



1460Z/2

Icon	Icon	Icon	Quantity	Part No.
			1	1460Z/2



Tap Wrenches with Chrome Finish



600



3-10 mm	1	600.003.010
5-12 mm	1	600.005.012

Imperial Double Thread Restorers



1450D-WW



230 mm	1	1450D-WW
--------	---	----------

Metric Double Thread Restorers



1450D-ISO



230 mm	1	1450D-ISO
--------	---	-----------

Double Thread Restorers Set in Wooden Box



1450D/2



40 x 70 x 270 mm	M5-M27	1	1450D/2
------------------	--------	---	---------

1450D-ISO

1450D-WW



Tool Storage & Toolkits



TOOL TROLLEYS

53" Tool Trolley General Purpose Tool Kit
- 488 Pcs



XXL



986 x 501 x 1430 mm



1 XXL

1476KXXL7BK		
2058-BR, 6954, 6963, 7757, 7764, K6650-1/4-1P		
6700SM-10, 6700SM-11, 6700SM-12, 6700SM-13, 6700SM-14, 6700SM-4, 6700SM-4.5, 6700SM-5, 6700SM-5.5, 6700SM-6, 6700SM-7, 6700SM-8, 6700SM-9		
6700TORX-E10, 6700TORX-E4, 6700TORX-E5, 6700TORX-E6, 6700TORX-E7, 6700TORX-E8		
6950SL		
6956		
6960, 6962, 6962L, 696EX-11		
6966		
6972H		
7400SM-10, 7400SM-11, 7400SM-12, 7400SM-13, 7400SM-14, 7400SM-15, 7400SM-16, 7400SM-17, 7400SM-18, 7400SM-19, 7400SM-20, 7400SM-21, 7400SM-22, 7400SM-6, 7400SM-7, 7400SM-8, 7400SM-9		
7400TORX-E10, 7400TORX-E11, 7400TORX-E12, 7400TORX-E14, 7400TORX-E16, 7400TORX-E18, 7400TORX-E8		
7406ZZ-16, 7406ZZ-21		
7409BH-10, 7409BH-4, 7409BH-5, 7409BH-6, 7409BH-8		
7409F-10, 7409F-6.5, 7409F-8		
7409TORX-R-T27, 7409TORX-R-T30, 7409TORX-R-T40, 7409TORX-R-T45, 7409TORX-R-T50		
7409TORX-T25, 7409TORX-T27, 7409TORX-T30, 7409TORX-T40, 7409TORX-T45, 7409TORX-T50		
7750SL		
7758		
7759		
7760		

7761-W		
7765		
7766		
7767		
776EX-11		
7800SM-10, 7800SM-11, 7800SM-12, 7800SM-13, 7800SM-14, 7800SM-15, 7800SM-16, 7800SM-17, 7800SM-18, 7800SM-19, 7800SM-20, 7800SM-21, 7800SM-22, 7800SM-23, 7800SM-24, 7800SM-25, 7800SM-26, 7800SM-27, 7800SM-28, 7800SM-29, 7800SM-30, 7800SM-32, 7800SM-33, 7800SM-34, 7800SM-36, 7800SM-8, 7800SM-9		
7800TORX-E10, 7800TORX-E11, 7800TORX-E12, 7800TORX-E14, 7800TORX-E16, 7800TORX-E18, 7800TORX-E20, 7800TORX-E24, 7800TORX-E8		
7805SM-10, 7805SM-12, 7805SM-13, 7805SM-14, 7805SM-15, 7805SM-16, 7805SM-17, 7805SM-18, 7805SM-19, 7805SM-20, 7805SM-21, 7805SM-22, 7805SM-23, 7805SM-24, 7805SM-25, 7805SM-26, 7805SM-27, 7805SM-28, 7805SM-29, 7805SM-30, 7805SM-32		
7809M-10, 7809M-12, 7809M-14, 7809M-4, 7809M-5, 7809M-6, 7809M-7, 7809M-8		
7809M-10-140, 7809M-5-100, 7809M-6-100, 7809M-7-100, 7809M-8-120		
7809XZN-10, 7809XZN-10-100, 7809XZN-12, 7809XZN-12-100, 7809XZN-14, 7809XZN-14-100, 7809XZN-16, 7809XZN-18, 7809XZN-6, 7809XZN-8, 7809XZN-8-100		
8150SL		
8160-3, 8160-5		
8160W-10		
8164-1/2		
8171		
8166		
8167		
A6800DM-10, A6800DM-11, A6800DM-12, A6800DM-13, A6800DM-14, A6800DM-4, A6800DM-5, A6800DM-5.5, A6800DM-6, A6800DM-7, A6800DM-8, A6800DM-9		
A7402DM-10, A7402DM-11, A7402DM-12, A7402DM-13, A7402DM-14, A7402DM-15, A7402DM-16, A7402DM-17, A7402DM-18, A7402DM-19, A7402DM-21, A7402DM-7, A7402DM-8, A7402DM-9		
K6625-1/4-1P		
K6650-1/2-1P, K6650-3/8-1P		
2101G-160		
2421 G-140IP, 2421 G-180		
2427 G-200		
2430 G-160		
2628 G-180		
2800-140, 2800-180, 2800-225		
2890-125, 2890-180, 2890-210		
2900-140, 2900-180, 2900-215		
2951-250		
2952-165		
2990-140, 2990-180, 2990-200		
3416 A		
4130		
7224		
BE256-155, BE256-178, BE256-250		

BLTS7P		
CR W 01		
1150-1/2H/P		
1544		
2633/S4x 4		
59/S100BCx 100		
806-1-3		
808050L		
BE-7607		
BE-8020L		
BE-8155TB, BE-8256TB, BE-8258TB		
BE-8355		
BE-8600		
BE-8602		
BE-8610TB, BE-8620TB, BE-8623TB, BE-8624TB		
BE-8802		
BE-8810TB, BE-8820TB, BE-8823TB, BE-8824TB		
BE-8907, BE-8908, BE-8909, BE-8910, BE-8915, BE-8920, BE-8925, BE-8927, BE-8930, BE-8940		
BE-8986		
BE-9770x 9		
BE-9785x 13		
MTC-5-16-C1		
1-170-08-2-2		
1-210-08-2-2		
1-230-08-2-2		
208		
2484T-30, 2484T-60		
2509		
2535L		
319		
3625N-32		
3681-16		
3734-2, 3734-3, 3734-4, 3734-5, 3734-6, 3734-8		
3735-4-120, 3735-5-120		
3740-150, 3740-250		
3906-300-32-5Px 5		
479-08		
481-1000, 481-400		
5515T		
782-U		
KBGU-5P-DISPENx 5		
KERU-01		
111M-10, 111M-11, 111M-12, 111M-13, 111M-14, 111M-15, 111M-16, 111M-17, 111M-18, 111M-19, 111M-20, 111M-21, 111M-22, 111M-23, 111M-24, 111M-25, 111M-26, 111M-27, 111M-28, 111M-29, 111M-30, 111M-32, 111M-33, 111M-34, 111M-36, 111M-6, 111M-7, 111M-8, 111M-9		
1RM-10, 1RM-11, 1RM-12, 1RM-13, 1RM-14, 1RM-15, 1RM-16, 1RM-17, 1RM-18, 1RM-19, 1RM-21, 1RM-22, 1RM-24, 1RM-27, 1RM-30, 1RM-32, 1RM-6, 1RM-7, 1RM-8, 1RM-9		
4040M-10-11, 4040M-12-13, 4040M-14-15, 4040M-16-17, 4040M-18-19, 4040M-8-9		
8069, 8071, 8073		

Tool Trolley General Purpose Tool Kit - 758 pcs



MONSTER



1370 x 501 x 1100 mm

1 MONSTER

FF1BSET-MONSTER



Tool Trolley Auto Repair Tool Kit - 357 pcs



AUTO



976 x 510 x 820 mm

1 AUTO

FF1ASET-AUTO



Tool Trolley General Purpose Tool Kit - 158 pcs



BASIC1



952 x 510 x 782 mm

1 BASIC

FF1ASET-BASIC



Tool Trolley General Purpose Tool Kit - 560 pcs



XLARGE



1360 x 510 x 820 mm

1 XLARGE

FF1ASET-XLARGE



Tool Trolley General Purpose Tool Kit - 346 pcs



LARGE



952 x 510 x 782 mm

1 LARGE

FF1ASET-LARGE



Tool Trolley General Purpose Tool Kit - 187 pcs



1475KXL6CBK-FF6



986 x 501 x 1100 mm

1 1475KXL6CBK-FF6

FF1A65



FF1A66



FF1A67



FF1A68



FF1A194



Tool Trolley General Purpose Tool Kit - 210 pcs



1475KXL6CBK-FF5



986 x 501 x 1100 mm

1 1475KXL6CBK-FF5

FF1A48



FF1A49



FF1A50



FF1A51



FF1A213



FF1A53

26" E77 Premium Storage HUB Tool Trolleys with 9 Drawers



1477K9



976 x 510 x 820 mm
976 x 510 x 820 mm
976 x 510 x 820 mm
976 x 510 x 820 mm
976 x 510 x 820 mm

1 1477K9
1 1477K9BLACK
1 1477K9GREY
1 1477K9WHITE
1 1477K9RED

26" E77 Premium Storage HUB Tool Trolleys with 8 Drawers



1477K8



976 x 510 x 820 mm
976 x 510 x 820 mm

1 1477K8
1 1477K8BLACK



976 x 510 x 820 mm
976 x 510 x 820 mm
976 x 510 x 820 mm

1 1477K8GREY
1 1477K8WHITE
1 1477K8RED

26" E77 Premium Storage HUB Tool Trolleys with 7 Drawers



1477K7



976 x 510 x 820 mm
976 x 510 x 820 mm
976 x 510 x 820 mm
976 x 510 x 820 mm
976 x 510 x 820 mm

1 1477K7
1 1477K7BLACK
1 1477K7GREY
1 1477K7WHITE
1 1477K7RED

26" E77 Premium Storage HUB Tool Trolleys with 6 Drawers



1477K6



976 x 510 x 820 mm
976 x 510 x 820 mm
976 x 510 x 820 mm
976 x 510 x 820 mm
976 x 510 x 820 mm

1 1477K6
1 1477K6BLACK
1 1477K6GREY
1 1477K6WHITE
1 1477K6RED

Premium E87 Storage HUB Top Chests with 4-Drawers



1487K4



402 x 510 x 692 mm
402 x 510 x 692 mm
402 x 510 x 692 mm

1 1487K4
1 1487K4BLACK
1 1487K4GREY

Premium E87 Storage HUB Top Chests on Wheels with 4 Drawers



1487K4W



564 x 510 x 692 mm
564 x 510 x 692 mm

1 1487K4W
1 1487K4BKW

26" E72 Storage HUB Tool Trolleys with 8 Drawers



1472K8



952 x 510 x 782 mm
952 x 510 x 782 mm
952 x 510 x 782 mm
952 x 510 x 782 mm
952 x 510 x 782 mm
952 x 510 x 782 mm

1 1472K8
1 1472K8BLACK
1 1472K8GREY
1 1472K8WHITE
1 1472K8RED
1 1472K8BLUE

26" E72 Storage HUB Tool Trolleys with 7 Drawers



1472K7



952 x 510 x 782 mm	1	1472K7
952 x 510 x 782 mm	1	1472K7BLACK
952 x 510 x 782 mm	1	1472K7GREY
952 x 510 x 782 mm	1	1472K7WHITE
952 x 510 x 782 mm	1	1472K7RED
952 x 510 x 782 mm	1	1472K7BLUE

26" E72 Storage HUB Tool Trolleys with 6 Drawers



1472K6



952 x 510 x 782 mm	1	1472K6
952 x 510 x 782 mm	1	1472K6BLACK
952 x 510 x 782 mm	1	1472K6GREY
952 x 510 x 782 mm	1	1472K6WHITE
952 x 510 x 782 mm	1	1472K6RED
952 x 510 x 782 mm	1	1472K6BLUE

26" E72 Storage HUB Tool Trolleys with 5 Drawers



1472K5



952 x 510 x 782 mm	1	1472K5
952 x 510 x 782 mm	1	1472K5BLACK
952 x 510 x 782 mm	1	1472K5GREY
952 x 510 x 782 mm	1	1472K5WHITE
952 x 510 x 782 mm	1	1472K5RED
952 x 510 x 782 mm	1	1472K5BLUE

26" E72 Storage HUB Top Chests with 4 Drawers



1482K4



386 x 510 x 692 mm	1	1482K4
386 x 510 x 692 mm	1	1482K4BLACK
386 x 510 x 692 mm	1	1482K4GREY
386 x 510 x 692 mm	1	1482K4WHITE
386 x 510 x 692 mm	1	1482K4RED
386 x 510 x 692 mm	1	1482K4BLUE

26" E72 Storage HUB Top Chests on Wheels with 5 Drawers



1482K5W



542 x 515 x 699 mm	1	1482K5W
--------------------	---	---------

26" E72 Storage HUB Top Chests on Wheels with 4 Drawers



1482K4W



542 x 515 x 699 mm	1	1482K4W
542 x 515 x 699 mm	1	1482K4BKW

Top Tool Panels for 1477K Storage HUB Tool Trolleys



1477K-AC12



396 x 25 x 610 mm	1	1477K-AC12
-------------------	---	------------

Top Side Tool Panels for 1477K Storage HUB Tool Trolleys



1477K-AC13



400 x 25 x 365 mm	1	1477K-AC13
-------------------	---	------------



Work Document Boards for 1477K Storage HUB Tool Trolleys



1477K-AC14



327 x 25 x 240 mm



1 1477K-AC14

Jacket Holders for 1477K Storage HUB Tool Trolleys



1477K-AC17



68 x 65 x 435 mm



1 1477K-AC17

Spray Canister Holders for 1477K and 1472K Storage HUB Tool Trolleys



1477K-AC20



125 x 105 x 307 mm



1 1477K-AC20

Laptop Boards for 1477K Storage HUB Tool Trolleys



1477K-AC15



80 x 298 x 424 mm



1 1477K-AC15

Roll Holders for 1477K and 1472K Storage HUB Tool Trolleys



1477K-AC18



33 x 265 x 313 mm



1 1477K-AC18

Power Tool Holders for 1477K and 1472K Storage HUB Tool Trolleys



1477K-AC21



115 x 175 x 302 mm



1 1477K-AC21

Windshield Supports for 1477K Storage HUB Tool Trolleys



1477K-AC16



106 x 115 x 208 mm



1 1477K-AC16

Document Holders for 1477K and 1472K Storage HUB Tool Trolleys



1477K-AC19



241 x 65 x 300 mm



1 1477K-AC19

Side Tool Panels for 1477K and 1472K Storage HUB Tool Trolleys



1477K-AC22



659 x 18 x 300 mm



1 1477K-AC22

Folding Tray for 1472K and 1477K Trolleys



1477K-AC30



22 x 430 x 460 mm



1 1477K-AC30

Pin Code Locking Systems for 1477K Storage HUB Tool Trolleys



1477K-AC24



135 x 36 x 62 mm



1 1477K-AC24

Wooden Top Middle Parts for 1477K & 1487K Storage HUB Tool Trolleys



1477K-ACTW



20 x 510 x 550 mm



1 1477K-ACTW

Removable Drawer Dividers for 1477K Storage HUB Tool Trolleys



1477K-AC26



48 x 2 x 147 mm 0.07 kg



1 1477K-AC26

Mifare Locking Systems for 1477K Storage HUB Tool Trolleys



1477K-AC25



135 x 36 x 62 mm



1 1477K-AC25

Composite Bench Tops for 1477K Storage HUB Tool Trolley



1477K-ACTP



20 x 510 x 550 mm



1 1477K-ACTP

Bottom Drawers for 1477K Storage HUB Tool Trolleys



1477K-AC10



110 x 390 x 495 mm



1 1477K-AC10

Stainless Steel Top Middle Parts for 1477K & 1487K Storage HUB Tool Trolleys



1477K-ACTSS



20 x 510 x 550 mm



1 1477K-ACTSS

MDF Top Middle Parts for 1477K Storage HUB Tool Trolleys



1477K-ACTD



20 x 510 x 550 mm



1 1477K-ACTD



Stainless Steel Tops for 1472K & 1482K Storage HUB Tool Trolley



1472K-ACTSS



30 x 501 x 682 mm

1 1472K-ACTSS

Chestnut Wood Tops for 1472K & 1482K Storage HUB Tool Trolley



1472K-ACTW



30 x 501 x 680 mm

1 1472K-ACTW

MDF Tops for 1472K & 1482K Storage HUB Tool Trolley



1472K-ACTD



30 x 501 x 682 mm

1 1472K-ACTD

53" Tool Trolleys with 7 Drawers



1476KXXL7BK



986 x 501 x 1430 mm

1 1476KXXL7BK

53" Double Bank Tool Trolleys with 12 Drawers



1471KXXL12BKTSS



1016 x 501 x 1440 mm

1 1471KXXL12BKTSS

53" Special Tool Trolley with 8 Drawers and Side Cabinet



1475KXXL8CWTSS



1218 x 500 x 1505 mm 1089 kg

1 1475KXXL8CWTSS

40" Classic C75 Tool Trolleys with 12 Drawers



1475KXL12



986 x 501 x 1100 mm

1 1475KXL12

986 x 501 x 1100 mm

1 1475KXL12BLACK

986 x 501 x 1100 mm

1 1475KXL12RED

40" Classic C75 Tool Trolleys with 8 Drawers



1475KXL8



986 x 501 x 1100 mm

1 1475KXL8

986 x 501 x 1100 mm

1 1475KXL8BLACK

986 x 501 x 1100 mm

1 1475KXL8BLUE

986 x 501 x 1100 mm

1 1475KXL8RED

40" Classic C75 Tool Trolleys with 7 Drawers



1475KXL7



986 x 501 x 1100 mm

1 1475KXL7

986 x 501 x 1100 mm

1 1475KXL7BLACK

986 x 501 x 1100 mm

1 1475KXL7BLUE

986 x 501 x 1100 mm

1 1475KXL7RED

40" Classic C75 Tool Trolleys with 6 Drawers



1475KXL6



986 x 501 x 1100 mm	1	1475KXL6
986 x 501 x 1100 mm	1	1475KXL6BLACK
986 x 501 x 1100 mm	1	1475KXL6BLUE
986 x 501 x 1100 mm	1	1475KXL6RED

40" Classic C75 Tool Trolleys with 6 Drawers and Side Cabinet



1475KXL6C



986 x 501 x 1100 mm	1	1475KXL6C
986 x 501 x 1100 mm	1	1475KXL6CBLACK

40" Classic C85 Top Chests with 4 Drawers



1485KXL4



417 x 500 x 1016 mm	1	1485KXL4
417 x 500 x 1016 mm	1	1485KXL4BLACK
417 x 500 x 1016 mm	1	1485KXL4BLUE
417 x 500 x 1016 mm	1	1485KXL4RED

26" Classic C75 Tool Trolleys with 8 Drawers



1475K8



956 x 501 x 763 mm	1	1475K8
956 x 501 x 763 mm	1	1475K8BLACK
956 x 501 x 763 mm	1	1475K8BLUE
956 x 501 x 763 mm	1	1475K8RED

26" Classic C75 Tool Trolleys with 7 Drawers



1475K7



956 x 501 x 763 mm	1	1475K7
956 x 501 x 763 mm	1	1475K7BLACK
956 x 501 x 763 mm	1	1475K7BLUE
956 x 501 x 763 mm	1	1475K7RED

26" Classic C75 Tool Trolleys with 6 Drawers



1475K6



956 x 501 x 763 mm	1	1475K6
956 x 501 x 763 mm	1	1475K6BLACK
956 x 501 x 763 mm	1	1475K6BLUE
956 x 501 x 763 mm	1	1475K6RED

26" Low Height Tool Trolleys with 7 Drawers



1470K7LH



755 x 501 x 760 mm	1	1470K7LH
--------------------	---	----------

26" Classic C85 Top Chests with 4 Drawers



1485K4



417 x 500 x 677 mm	1	1485K4
417 x 500 x 677 mm	1	1485K4BLACK
417 x 500 x 677 mm	1	1485K4BLUE
417 x 500 x 677 mm	1	1485K4RED

Stainless Steel Tops for 1475KXXL Tool Trolley



1475KXXL-ACTSS



45 x 495 x 1347 mm	1	1475KXXL-ACTSS
--------------------	---	----------------

Chestnut Wood Tops for 1475KXXL Tool Trolley



1475KXXL-ACTW



45 x 495 x 1347 mm	1	1475KXXL-ACTW
--------------------	---	---------------



Stainless Steel Tops for Tool Trolleys 40 mm



1470K-ACTSS



40 x 495 x 1010 mm
38 x 495 x 670 mm

1 1470KXL-ACTSS
1 1470K-ACTSS

Chestnut Tops for Tool Trolleys 40 mm



1470K-ACTW



40 x 500 x 1012 mm
40 x 497 x 674 mm

1 1470KXL-ACTW
1 1470K-ACTW

MDF Top for Tool Trolleys 40 mm



1470K-ACTD



40 x 495 x 1012 mm
40 x 497 x 674 mm

1 1470KXL-ACTD
1 1470K-ACTD

Side Cabinet with Lock for 1475KXL Trolley



1475KXL-AC20BK



820 x 503 x 419 mm

1 1475KXL-AC20BK

Foldable Trays for 1470 and 1475 Drawers



1470K-AC1



9 x 455 x 395 mm

1 1470K-AC1

Can Holders for 1470 and 1475 Drawers



1470K-AC3



140 x 90 x 457 mm

1 1470K-AC3

Document Holders for 1470 and 1475 Drawers



1470K-AC4



180 x 83 x 360 mm

1 1470K-AC4

Tool Holders for 23 Pcs Screwdrivers/Pry Bars

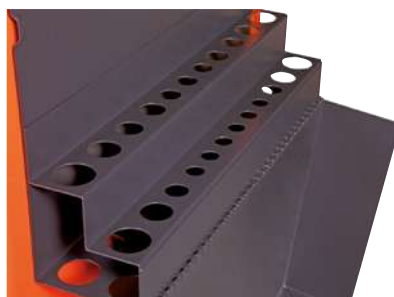

1470K-AC2



280 x 100 x 428 mm

1 1470K-AC2

Metallic Side Panels with Slots and Dots



1470K-ACSIDE



822 x 20 x 418 mm

1 1470K-ACSIDE

26" ABS Tops for 26" Trolleys



1470K-AC7



45 x 497 x 674 mm

1 1470K-AC7

Metallic Side Panels for 1495TP Hook System



1475K-ACSIDE



822 x 20 x 418 mm

1 1475K-ACSIDE

Metallic Adjustable Trays for Side Cabinet



1470KXLC-TRAY



470 x 10 x 310 mm

1 1470KXLC-TRAY

Three Tray Steel Roll Carts



1470KC3A



1051 x 435 x 764 mm

1 1470KC3A

Two Tray Steel Roll Carts



1470KC2



1051 x 435 x 764 mm

1 1470KC2

Middle Trays for 1470KC2 Roll Cart



1470KCTRAY



750 mm

420 mm

1 1470KCTRAY

Folding Transport Trolleys with Aluminium Tray



1430FT120



1077 x 520 x 487 mm

6.4 kg

1 1430FT120

General Purpose 11 Foam Tool Kit - 758 pcs



FF1BSET-MONSTER



40 x 445 x 880 mm

1 FF1BSET-MONSTER

FF1B01LM



FF1B02LM



FF1B03LM



FF1B04LM



FF1B05LM



FF1B10LM



FF1B11LM



FF1B08LM



FF1B09LM



FF1B06LM



FF1B07LM



Foam Inlay for 40" Trolley 1/4" Metric & Imperial Socket Sets - 141 pcs



FF1B01LM



35 x 445 x 880 mm

1 FF1B01LM

6700SM-10, 6700SM-11, 6700SM-12, 6700SM-13, 6700SM-14, 6700SM-4, 6700SM-4.5, 6700SM-5, 6700SM-5.5, 6700SM-6, 6700SM-7, 6700SM-8, 6700SM-9

6700SZ-1/2, 6700SZ-1/8, 6700SZ-9/16, 6700SZ-1/4, 6700SZ-11/32, 6700SZ-3/16, 6700SZ-3/8, 6700SZ-5/16, 6700SZ-7/16, 6700SZ-7/32, 6700SZ-9/32, 6700SZ-5/32

6700TORX-E4, 6700TORX-E5, 6700TORX-E6, 6700TORX-E7, 6700TORX-E8, 6700TORX-E10

6950SL

6962L, 6960, 6961

6972H

7400SM-10, 7400SM-11, 7400SM-12, 7400SM-13, 7400SM-14, 7400SM-15, 7400SM-16, 7400SM-17, 7400SM-18, 7400SM-19, 7400SM-20, 7400SM-21, 7400SM-22, 7400SM-6, 7400SM-7, 7400SM-8, 7400SM-9

7400TORX-E10, 7400TORX-E11, 7400TORX-E12, 7400TORX-E14, 7400TORX-E16, 7400TORX-E18

7406ZZ-16, 7406ZZ-21

7409TORX-R-T27, 7409TORX-R-T30, 7409TORX-R-T40, 7409TORX-R-T45, 7409TORX-R-T50

7409TORX-T25, 7409TORX-T27, 7409TORX-T30, 7409TORX-T40, 7409TORX-T45, 7409TORX-T50

7750SL

2058-BR, K6650-1/4-1P, 6954, 6963, 7764

8164-1/2

A6800DM-10, A6800DM-12, A6800DM-13, A6800DM-4, A6800DM-5, A6800DM-5.5, A6800DM-6, A6800DM-7, A6800DM-8, A6800DM-9, A6800DM-11, A6800DM-14

A6800DZ-9/16, A6800DZ-1/2, A6800DZ-1/4, A6800DZ-11/32, A6800DZ-3/16, A6800DZ-3/8, A6800DZ-5/16, A6800DZ-7/16, A6800DZ-7/32, A6800DZ-9/32

A7400DZ-1/2, A7400DZ-11/16, A7400DZ-3/4, A7400DZ-3/8, A7400DZ-5/8, A7400DZ-7/16, A7400DZ-17/32, A7400DZ-9/16, A7400DZ-19/32, A7400DZ-13/16, A7400DZ-7/8, A7400DZ-1/4, A7400DZ-5/16

K6625-1/4-1P	
6956	
6966	
7760, 7761	
7762	
7765	
7766	
7409BH-4, 7409BH-5, 7409BH-6, 7409BH-8, 7409BH-10	
A7402DM-10, A7402DM-11, A7402DM-12, A7402DM-13, A7402DM-14, A7402DM-15, A7402DM-16, A7402DM-17, A7402DM-18, A7402DM-19, A7402DM-8, A7402DM-9	
K6650-3/8-1P	
7756	

Foam Inlay for 40" Trolley 1/2" Metric & Imperial Socket Sets - 76 pcs



FF1B02LM



40 x 445 x 880 mm

1 FF1B02LM

7800DM-10, 7800DM-11, 7800DM-12, 7800DM-13, 7800DM-14, 7800DM-15, 7800DM-16, 7800DM-17, 7800DM-18, 7800DM-19, 7800DM-20, 7800DM-21, 7800DM-22, 7800DM-24, 7800DM-27, 7800DM-30, 7800DM-32, 7800DM-34, 7800DM-36

7800DZ-1, 7800DZ-1.1/16, 7800DZ-1.1/4, 7800DZ-1.1/8, 7800DZ-1.3/16, 7800DZ-1/2, 7800DZ-11/16, 7800DZ-13/16, 7800DZ-15/16, 7800DZ-25/32, 7800DZ-3/4, 7800DZ-3/8, 7800DZ-5/8, 7800DZ-7/16, 7800DZ-7/8, 7800DZ-9/16, 7800DZ-19/32

7809M-10, 7809M-12, 7809M-14, 7809M-4, 7809M-5, 7809M-6, 7809M-7, 7809M-8

8150SL

SBS87

K7801M-13, K7801M-15, K7801M-16, K7801M-17, K7801M-18, K7801M-19, K7801M-21, K7801M-22, K7801M-24

K8160D-2

K7806M-13, K7806M-14, K7806M-16, K7806M-17, K7806M-18, K7806M-19, K7806M-21, K7806M-22, K7806M-24

7809M-5-100, 7809M-6-100, 7809M-7-100, 7809M-8-120, 7809M-10-140

K6650-1/2-1P

8160-3, 8160-5, 8160-10

8171

8166

Foam Inlay for 40" Trolley Combination Spanner & Ratcheting Spanner Sets - 36 pcs



FF1B03LM



35 x 445 x 880 mm

1 FF1B03LM

111M-10, 111M-11, 111M-12, 111M-13, 111M-14, 111M-15, 111M-16, 111M-17, 111M-18, 111M-19, 111M-20, 111M-21, 111M-22, 111M-24, 111M-27, 111M-30, 111M-32, 111M-34, 111M-8, 111M-9

1RM-10, 1RM-11, 1RM-12, 1RM-13, 1RM-14, 1RM-15, 1RM-16, 1RM-17, 1RM-18, 1RM-19, 1RM-21, 1RM-22, 1RM-24, 1RM-27, 1RM-8, 1RM-9

Foam Inlay for 40" Trolley Combination Spanner, Flex-Head Spanners & Telescopic Mirror - 26 pcs



FF1B04LM



35 x 445 x 880 mm

1 FF1B04LM

1RM-30, 1RM-32

111Z-1, 111Z-1.1/16, 111Z-1.1/4, 111Z-1.1/8, 111Z-1/2, 111Z-11/16, 111Z-13/16, 111Z-15/16, 111Z-3/4, 111Z-3/8, 111Z-5/16, 111Z-5/8, 111Z-7/16, 111Z-7/8, 111Z-9/16

4040M-10-11, 4040M-12-13, 4040M-14-15, 4040M-16-17, 4040M-18-19, 4040M-8-9

5515T

BLTS7P

2535L

Foam Inlay for 40" Trolley Pliers, Compact Pliers, Spanners & Calipers - 32 pcs



FF1B05LM



35 x 445 x 880 mm

1 FF1B05LM

1150-1/2H/P	
1520 G	
1620	
2101S-160	1000 V IEC60900
21HDG-160	
2223 S-150	1000 V IEC60900
2430 G-160	
2430 S-200	1000 V IEC60900
2628 G-180	
2628 S-180	1000 V IEC60900
2744	
426TOR9	6.35" x 9.5mm
KBGU-10P-DISPEN	
KERU-01	
MTC-5-16-C1	
8224	16
9029, 9031	
806-1-3	
C3330R	
C3530	
C3230	
C3640	

Foam Inlay for 40" Trolley ERGO™ Insulated and Precision Screwdriver Sets - 88 pcs



FF1B06LM



40 x 445 x 880 mm

1 FF1B06LM

700-2.5-50, 700-2-50, 700-3-50	
701-00-50, 701-0-50, 701-1-75	
703-10-50, 703-15-75, 703-6-50, 703-7-50, 703-8-50, 703-9-50	

808050L	
BE-8010S	
BE-8020, BE-8040	
BE-8040SL, BE-8050SL	
BE-8150, BE-8155, BE-8256	
BE-8355	
BE-8600, BE-8611, BE-8621, BE-8623	
BE-8600S	
BE-8602	
BE-8610SL, BE-8620SL	
BE-8702, BE-8725	
BE-8820SL	
BE-8870	
BE-8975B	
BE-9777B	
BE-9787	
BE-9770	
BE-9785	

Foam Inlay for 40" Trolley ERGO™ Screwdrivers & Bit Sets - 169 pcs



FF1B07LM



40 x 445 x 880 mm

1 FF1B07LM

BE-8256TB, BE-8258TB	
BE-8620TB, BE-8623TB	
59/S100BC	
7455-200	
BE-8907, BE-8908, BE-8909, BE-8910, BE-8915, BE-8920, BE-8925, BE-8927, BE-8930, BE-8940	
BE-8811, BE-8821	
BE-8830	
BE-8802	
BE5049T	
BE-7607	

Foam Inlay for 40" Trolley Striking, Filing & Extracting Sets - 45 pcs



FF1B08LM



40 x 445 x 880 mm

1 FF1B08LM

1-100-08-2-2	
1-170-08-2-2	
1-210-08-2-2	
1-230-08-2-2	
1435/5	
2484-30, 2484-45, 2484-60	
3734-2, 3734-3, 3734-4, 3734-5, 3734-6, 3734-8	
3735-4-120, 3735-5-120	
3740-150, 3740-250	
4543-3	
4611-3	
481-400	
7865	
3625N-32	
1418-4, 1418-5, 1418-6, 1418-7.5	

Foam Inlay for 40" Trolley Hexagonal T-Handle, Multi-Position Pry Bars & Feeler Gauges Sets - 21 pcs



FF1B09LM



35 x 445 x 880 mm

1 FF1B09LM

900T-025-100, 900T-030-100, 900T-040-150, 900T-050-150, 900T-060-200, 900T-080-200	
901T-010-100, 901T-015-150, 901T-020-150, 901T-025-150, 901T-027-150, 901T-030-200, 901T-040-200	
BE256-155, BE256-178, BE256-250	
BE66152	
BT10P325, BT10P330, BT10P338	
1544	



Foam Inlay for 40" Trolley Hand Hacksaw, Cirdclip Pliers & Grips - 20 pcs



FF1B10LM

45 x 445 x 880 mm 1 FF1B10LM

2633/S4	
2800-140, 2800-180	
2890-125, 2890-180	
2900-140, 2900-180	
2951-180	
2952-165	
2963-280	
2965-200	
2990-125, 2990-180	
BE-8986	
325	
2681	
CR B 02	

Foam Inlay for 40" Trolley Metal Clips for 1/4", 3/8", 1/2" Sockets & 3/4" Sockets Set - 104 pcs



FF1B11LM

50 x 445 x 880 mm 1 FF1B11LM

RAIL-264	
CLIPS-1/4	
CLIPS-3/8	
CLIPS-1/2	
SLX 17	

General Purpose 12 Foam Tool Kit - 560 pcs



FF1ASET-XLARGE

40 x 543 x 445 mm 1 FF1ASET-XLARGE

FF1A195LM	
FF1A196LM	
FF1A197LM	
FF1A198LM	
FF1A199LM	
FF1A200LM	
FF1A201LM	
FF1A202LM	
FF1A203LM	
FF1A204LM	
FF1A205LM	
FF1A206LM	

General Purpose 6 Foam Tool Kit - 346 pcs



FF1ASET-LARGE

40 x 543 x 445 mm 1 FF1ASET-LARGE

FF1A207LM	
FF1A208LM	
FF1A209LM	
FF1A210LM	
FF1A211LM	
FF1A212LM	

General Purpose 3 Foam Tool Kit - 158 pcs



FF1ASET-BASIC

40 x 543 x 445 mm 1 FF1ASET-BASIC

FF1A214LM	
FF1A215LM	
FF1A216LM	

MRO 7 Foam Toolkit - 256 Pcs



FF1ASET-MRO2

530 x 600 x 800 mm 1 FF1ASET-MRO2

FF1A130	
FF1A131	
FF1A132	
FF1A133	
FF1A134	
FF1A135	
FF1A136	

MRO 5 Foam Toolkit - 188 Pcs



FF1ASET-MRO3

530 x 600 x 800 mm 1 FF1ASET-MRO3

FF1A138		
FF1A134		
FF1A139		
FF1A141		
FF1A137		

MRO 4 Foam Toolkit - 147 Pcs



FF1ASET-MRO4

 530 x 600 x 800 mm 1 FF1ASET-MRO4

FF1A143		
FF1A145		
FF1A134		
FF1A142		

MRO 3 Foam Toolkit - 84 Pcs



FF1ASET-MRO5

 530 x 600 x 800 mm 1 FF1ASET-MRO5

FF1A147		
FF1A146		
FF1A134		

Auto Repair 8 Foam Tool Kit - 357 pcs



FF1ASET-AUTO

 40 x 543 x 445 mm 1 FF1ASET-AUTO

FF1A218LM		
FF1A219LM		
FF1A220LM		
FF1A221LM		
FF1A222LM		
FF1A223LM		
FF1A224LM		
FF1A225LM		

Auto Repair 5 Foam Toolkit - 196 Pcs



FF1ASET-AUTO1

 50 x 543 x 445 mm 1 FF1ASET-AUTO1

FF1A19		
FF1A20		
FF1A21		
FF1A23		
FF1A22		

Auto Repair 4 Foam Toolkit - 168 Pcs



FF1ASET-AUTO2

 50 x 543 x 445 mm 1 FF1ASET-AUTO2

FF1A19		
FF1A24		
FF1A21		
FF1A25		

Auto Repair 3 Foam Toolkit - 140 Pcs



FF1ASET-AUTO3

 50 x 543 x 445 mm 1 FF1ASET-AUTO3

FF1A28		
FF1A26		
FF1A27		



Auto Repair 4 Foam Toolkit - 177 Pcs



FF1ASET-AUTO6



50 x 543 x 445 mm

1 FF1ASET-AUTO6

FF1A19	
FF1A72	
FF1A70	
FF1A71	

Auto Repair 2 Foam Tool Kit - 62 pcs



FF1ASET-AUTO-M1



50 x 543 x 445 mm

1 FF1ASET-AUTO-M1

BP910	
BP909TH	
BE-9678	
BE-9675	
29M-30	
2997-250	
1995LM-9, 1995LM-8, 1995LM-6	
3750	
1177-SCRIBE	
K7801M-9, K7801M-10, K7801M-11, K7801M-12, K7801M-13, K7801M-14, K7801M-15, K7801M-16, K7801M-17, K7801M-18, K7801M-19, K7801M-21, K7801M-22, K7801M-23, K7801M-24, K7801M-30, K7801M-32	
K7806M-15, K7806M-21, K7806M-24, K7806M-27	
K8901M-32, K8901M-34, K8901M-36	
K8964D	
K8167S	
K8160D-3	
2800-150	

2900-150	
3734S/6	
BE-8258TB	

Auto Repair 2 Foam & SAC Alignment Tool Kit - 54 pcs



FF1ASET-AUTO-M2



60 x 543 x 445 mm

1 FF1ASET-AUTO-M2

BE301	
K7801TORX-E10, K7801TORX-E12, K7801TORX-E14, K7801TORX-E16, K7801TORX-E18, K7801TORX-E20	
K8160D-2	
BE301CM	
BWHEPSSH8	
BE51038, BE510310, BE510312	
BP822	
BP825	

Auto Repair 2 Foam Tool Kit - 34 pcs



FF1ASET-AUTO-M3



40 x 543 x 445 mm

1 FF1ASET-AUTO-M3

BE1GP5-T	
6968	
BE1SP1F	
BE6OF108	
BE6307414F	
BE6OFW	

BE1FFWF	
BE63064514F1	
BE6810Z, BE6810	
BE6FCP	
52	
1546	
5515M	
BE1P	
7455-60	
BE1FLD2, BE1FLD1, BE1FLD3	
BE65F65120	
7764, 6962-W, 6954	
8164-1/2	
BE6302712F	
BE6701VAG	
BE62110	
BE1310P427	
7406ZZ-21, 7406ZZ-16	
BE1SP14L	
BE1GP5	
2421GC-160IP	
8166	

Auto Repair 2 Foam Tool Kit - 23 pcs



FF1ASET-AUTO-M4



60 x 543 x 445 mm

1 FF1ASET-AUTO-M4

BS618	
4545-N1, 4545-N11	
4545-1, 4545-2	
MTB-3-16	
361-14	
8900SM-41	
BS52	
747-22, 747-21, 747-19, 747-17, 747-15, 747-14, 747-13, 747-12	
BS40VAG	
BS56	
BS100PSA1	
BS45BMW	
8157-24	
8171	

Auto Repair 2 Foam Tool Kit - 32 pcs



FF1ASET-AUTO-M5

45 x 543 x 445 mm 1 FF1ASET-AUTO-M5

319	
484-1000	
SB3654BM-20	
3625S-44	
B192.004.200	
BE-8258TB	
2484/S4	
6225D	
B194.030.150, B194.025.125, B194.020.100, B194.010.075	
600.005.012	
BBS165	
K7801TORX-E10, K7801TORX-E12, K7801TORX-E14, K7801TORX-E16, K7801TORX-E18, K7801TORX-E20, K7801TORX-E24	
BBR203P920, BBR203P925, BBR203P930, BBR203P940, BBR203P945, BBR203P950, BBR203P955, BBR203P960	

Auto Repair 2 Foam Tool Kit - 42 pcs



FF1ASET-AUTO-M6

40 x 543 x 445 mm 1 FF1ASET-AUTO-M6

FM10	
782-U	
BBR405	
BBR400	
BBR210P3	
BBR6131	
BBR204	

BBR1501	
BBR501011, BBR50121314	
2900-215	
7823	
BBR100	
1154	
6M-16-17, 6M-14-15	
1949M-17-19, 1949M-12-13, 1949M-10-11, 1949M-8-9	

Fit&Go 3/3 Foam Laser Marked Inlay 1/2" & 1/4" Socket Set & Bit Set - 139 pcs



FF1A195LM

40 x 445 x 543 mm 1 FF1A195LM

A6800DZ-9/16, A6800DZ-1/2, A6800DZ-1/4, A6800DZ-11/32, A6800DZ-3/16, A6800DZ-3/8, A6800DZ-5/16, A6800DZ-7/16, A6800DZ-7/32, A6800DZ-9/32	
K6625-1/4-1P	
K6650-1/4-1P, 6954, 6963, 2058-BR	
K6650-3/8-1P	
7767	
8167	
59/S31B	
SL25L	
S330L	

Fit&Go 3/3 Foam Laser Marked Inlay 1/2" Socket Set & 1/2" Deep Socket Set - 67 pcs



FF1A196LM

40 x 445 x 543 mm 1 FF1A196LM

7800DZ-1.1/16, 7800DZ-1.1/4, 7800DZ-1.1/8, 7800DZ-1.3/16, 7800DZ-1/2, 7800DZ-11/16, 7800DZ-13/16, 7800DZ-15/16, 7800DZ-25/32, 7800DZ-3/4, 7800DZ-3/8, 7800DZ-5/8, 7800DZ-7/16, 7800DZ-7/8, 7800DZ-9/16, 7800DZ-19/32	
--	--

7809M-10, 7809M-12, 7809M-14, 7809M-4, 7809M-5, 7809M-6, 7809M-7, 7809M-8	
7809M-5-100, 7809M-6-100, 7809M-7-100, 7809M-8-120, 7809M-10-140	
K6650-1/2-1P	
S1612L	
8967	
S240	

Fit&Go 3/3 Foam Laser Marked Inlay 1/2" Impact Socket Set, Cutting & Measuring - 36 pcs



FF1A197LM

40 x 445 x 543 mm 1 FF1A197LM

1150-1/2H/P	
2744	
426TOR9	
K7801M-13, K7801M-15, K7801M-16, K7801M-17, K7801M-18, K7801M-19, K7801M-21, K7801M-22, K7801M-24	
K8160D-2	
K7806M-13, K7806M-14, K7806M-16, K7806M-17, K7806M-18, K7806M-19, K7806M-21, K7806M-22, K7806M-24	
KBGU-10P-DISPEN	
KERU-01	
MTC-5-16-C1	
325	
1544	

Fit&Go 3/3 Foam Laser Marked Inlay Combination Spanners Set - 20 pcs



FF1A198LM

35 x 445 x 543 mm 1 FF1A198LM

111M-10, 111M-11, 111M-12, 111M-13, 111M-14, 111M-15, 111M-16, 111M-17, 111M-18, 111M-19, 111M-20, 111M-21, 111M-22, 111M-24, 111M-27, 111M-30, 111M-32, 111M-34, 111M-8, 111M-9	
--	--



Fit&Go 3/3 Foam Laser Marked Inlay Adjustable, Ratcheting & Swivel Head Spanners Set - 23 pcs



FF1A199LM

35 x 445 x 543 mm 1 FF1A199LM

- 1RM-10, 1RM-11, 1RM-12, 1RM-13, 1RM-14, 1RM-15, 1RM-16, 1RM-17, 1RM-18, 1RM-19, 1RM-21, 1RM-22, 1RM-24, 1RM-8, 1RM-9
- 4040M-10-11, 4040M-12-13, 4040M-14-15, 4040M-16-17, 4040M-18-19, 4040M-8-9
- 9029, 9031

Fit&Go 3/3 Foam Laser Marked Inlay Pipe Wrench, Holding, Cutting & Circlip Pliers - 14 pcs



FF1A200LM

35 x 445 x 543 mm 1 FF1A200LM

- 1520 G
- 1620
- 2101G-160
- 2223 S-150
- 2233 D-160
- 2430 G-190HD
- 2628 G-180
- 2890-180
- 2990-180
- C3330R
- C3530
- C3230
- C3640
- 8224

Fit&Go 3/3 Foam Laser Marked Inlay ERGO™ Screwdrivers, Precision Screwdrivers & L-Keys - 37 pcs



FF1A201LM

40 x 445 x 543 mm 1 FF1A201LM

- BE-8256TB
- BE-8620TB, BE-8623TB
- 700-2-50
- 701-00-50, 701-0-50, 701-1-75
- 703-10-50, 703-15-75, 703-6-50, 703-7-50, 703-8-50, 703-9-50
- BE-8040SL
- BE-8040
- BE-8150, BE-8155, BE-8256
- BE-8355
- BE-8600, BE-8611, BE-8621, BE-8623
- BE-8602
- BE-8811, BE-8821
- BE-8802
- BE-8870
- BE-9787

Fit&Go 3/3 Foam Laser Marked Inlay ERGO™ Screwdrivers, T-Handle Screwdrivers & L-Keys - 39 pcs



FF1A202LM

40 x 445 x 543 mm 1 FF1A202LM

- 900T-025-100, 900T-030-100, 900T-040-150, 900T-050-150, 900T-060-200, 900T-080-200
- BE-8907, BE-8908, BE-8909, BE-8910, BE-8915, BE-8920, BE-8925, BE-8927, BE-8930
- BE-8702, BE-8725
- BE-9770
- BE-9785

Fit&Go 3/3 Foam Laser Marked Inlay Ratcheting Screwdrivers, T-Handle Screwdrivers & Bit Set - 114 pcs



FF1A203LM

40 x 445 x 543 mm 1 FF1A203LM

- 59/S100BC
- 808050L
- 2058-BR
- 901T-010-100, 901T-015-150, 901T-020-150, 901T-025-150, 901T-027-150, 901T-030-200, 901T-040-200

Fit&Go 3/3 Foam Laser Marked Inlay Striking & Files - 40 pcs



FF1A204LM

40 x 445 x 543 mm 1 FF1A204LM

- 1-100-08-2-2
- 1-170-08-2-2
- 1-210-08-2-2
- 1-230-08-2-2
- 1435/5
- 3734-2, 3734-3, 3734-4, 3734-5, 3734-6, 3734-8
- 3735-4-120, 3735-5-120
- 3740-150, 3740-250
- 481-400
- 7865
- 3625N-32
- 1418-4, 1418-5, 1418-6, 1418-7.5

Fit&Go 3/3 Foam Laser Marked Inlay Awls, Hooks, Inspection Mirrors & Rivet Gun - 14 pcs



FF1A205LM



35 x 445 x 543 mm

1 FF1A205LM

2484-45	
2633/S4	
2951-180	
5515T	
BE66152	
BE-8986	
BT10P330	
2681	
1450D-ISO	
806-1-3	
5515FL	

Fit&Go 3/3 Foam Laser Marked Inlay 3/4" Socket Set - 17 pcs



FF1A206LM



50 x 445 x 543 mm

1 FF1A206LM

SLX 17	
--------	--

Fit&Go 3/3 Foam Laser Marked Inlay 1/4" & 3/8" Socket Set, T-Handle Screwdrivers, Caliper & Bit Set - 192 pcs



FF1A207LM



40 x 445 x 543 mm

1 FF1A207LM

1150-1/2H/P	
59/S100BC	
808050L	
2058-BR, K6650-1/4-1P, 6963, 6954	
6956	
K6650-3/8-1P	
8967/S3	
6966	
696EX-08	
904T-060-150	
905T-060-100	
6973A	
SL25L	
S330	

Fit&Go 3/3 Foam Laser Marked Inlay 1/2" Socket Set, 1/2" Impact Socket Set & Cutting - 56 pcs



FF1A208LM



45 x 445 x 543 mm

1 FF1A208LM

2744	
7809M-10, 7809M-12, 7809M-14, 7809M-4, 7809M-5, 7809M-6, 7809M-7, 7809M-8	
K7801M-13, K7801M-15, K7801M-16, K7801M-17, K7801M-18, K7801M-19, K7801M-21, K7801M-22, K7801M-24	
K8160D-2	
KBGU-10P-DISPEN	
KERU-01	
319	
K6650-1/2-1P	
S240	

Fit&Go 3/3 Foam Laser Marked Inlay Combination Spanners & Magnetic Pick-Up with LED Light - 56 pcs



FF1A209LM



35 x 445 x 543 mm

1 FF1A209LM

111M-10, 111M-11, 111M-12, 111M-13, 111M-14, 111M-15, 111M-16, 111M-17, 111M-18, 111M-19, 111M-20, 111M-21, 111M-22, 111M-24, 111M-27, 111M-30, 111M-32, 111M-34, 111M-8, 111M-9	
2535L	

Fit&Go 3/3 Foam Laser Marked Inlay ERGO™ Screwdrivers, Spanners & Pliers - 24 pcs



FF1A210LM



40 x 445 x 543 mm

1 FF1A210LM

1RM-10, 1RM-11, 1RM-12, 1RM-13, 1RM-14, 1RM-15, 1RM-16, 1RM-17, 1RM-18, 1RM-19, 1RM-8, 1RM-9	
1520 G	
2101G-160	
2430 G-190HD	
2628 G-180	
BE-8602	
BE-8611, BE-8621	
BE-8811, BE-8821	
BE-8802	
8224	
9031	



Fit&Go 3/3 Foam Laser Marked Inlay
ERGO™ Screwdrivers, T-Handle
Screwdrivers & L-Keys - 35 pcs



ergo



FF1A211LM



40 x 445 x 543 mm

1 FF1A211LM

900T-025-100, 900T-030-100, 900T-040-150, 900T-050-150, 900T-060-200, 900T-080-200		
BE-8910, BE-8915, BE-8920, BE-8925, BE-8930		
BE-8020, BE-8040		
BE-8050SL		
BE-8150, BE-8155		
BE-8355		
BE-9787		
BE-9770		

Fit&Go 3/3 Foam Laser Marked Inlay
ERGO™ Screwdrivers, T-Handle
Screwdrivers & L-Keys - 18 pcs



ergo



FF1A212LM



35 x 445 x 543 mm

1 FF1A212LM

1-100-08-2-2		
1-210-08-2-2		
1-230-08-2-2		
3734-2, 3734-3, 3734-4, 3734-5, 3734-6, 3734-8		
3735-4-120		
3740-150, 3740-250		
426TOR9		
481-400		
BE-8986		
MTC-5-16-C1		
2446		
3625N-32		

Fit&Go 3/3 Foam Inlay 1/4" & 3/8" Socket
Set & Torque Wrench - 85 pcs



FF1A213



52 x 445 x 543 mm

1 FF1A213

8150SL		
7800SM-8, 7800SM-9, 7800SM-12, 7800SM-13, 7800SM-10, 7800SM-11, 7800SM-30, 7800SM-32, 7800SM-24, 7800SM-22, 7800SM-23, 7800SM-27, 7800SM-16, 7800SM-17, 7800SM-14, 7800SM-15, 7800SM-21, 7800SM-18, 7800SM-19		
7455-200		
7809TORX-T45, 7809TORX-T40, 7809TORX-T30, 7809TORX-T20, 7809TORX-T25		
7809M-6, 7809M-5, 7809M-8, 7809M-7, 7809M-10, 7809M-14, 7809M-12		
7809M-6-140, 7809M-5-180, 7809M-10-140, 7809M-8-120		
6950SL		
6962-W, K6650-1/4-1P		
6960-W, 6960W-6		
6968		
6700SM-9, 6700SM-10, 6700SM-7, 6700SM-8, 6700SM-13, 6700SM-14, 6700SM-11, 6700SM-12, 6700SM-4, 6700SM-6, 6700SM-5		
6709M-6, 6709M-8, 6709M-4, 6709M-5, 6709M-3		
A6709M-2.5, A6709M-5, A6709M-6, A6709M-3, A6709M-4		
6962L, 6960-14		
7400SM-17, 7400SM-18, 7400SM-15, 7400SM-16, 7400SM-19, 7400SM-9, 7400SM-10, 7400SM-7, 7400SM-8, 7400SM-13, 7400SM-14, 7400SM-11, 7400SM-12, 7400SM-6		
7760-W, 7761-W		
7750SL		
7768		
8160-5, 8160-10		
8166		

Fit&Go 3/3 Foam Laser Marked Inlay 1/4" & 1/2" Socket Set, Pliers & Bit Set - 91 pcs



FF1A214LM



40 x 445 x 543 mm

1 FF1A214LM

2058-BR, K6650-1/4-1P, 6963		
6956		
K6650-1/2-1P		
SL25		
8072		
2971G-250		
806-1-3		
2171G-160		
59/S31B		
S240		

Fit&Go 3/3 Foam Laser Marked Inlay
ERGO™ Screwdrivers & Combination
Spanners - 31 pcs



FF1A215LM



40 x 445 x 543 mm

1 FF1A215LM

111M-10, 111M-11, 111M-12, 111M-13, 111M-14, 111M-15, 111M-16, 111M-17, 111M-18, 111M-19, 111M-20, 111M-21, 111M-22, 111M-24, 111M-8, 111M-9		
BE-8910, BE-8915, BE-8920, BE-8925, BE-8930		
BE-8020, BE-8040		
BE-8155		
BE-8355		
BE-8602		
BE-8611, BE-8621		
BE-8811, BE-8821		
BE-8802		

Fit&Go 3/3 Foam Laser Marked Inlay Striking, Cutting, Files & L-Keys - 36 pcs



FF1A216LM

40 x 445 x 543 mm 1 FF1A216LM

1-100-08-2-2		
1-210-08-2-2		
1-230-08-2-2		
3734-3, 3734-4, 3734-5		
3735-4-120		
481-400		
BE-8986		
BE-9770		
S4RM-8-11, S4RM-12-15, S4RM-16-19		
KB18-01		
KSBG18-10DISPEN		
MTG-3-16		
WR2-MM		
3740-200		
317		

Fit&Go 3/3 Foam Laser Marked Inlay Window Click Torque Wrench, Spark Plug Sockets & 1/4" Socket Set - 79 pcs



FF1A218LM

45 x 445 x 543 mm 1 FF1A218LM

1178-SCRIBE		
1547		
74WR-200		
7805ZZ-16, 7805ZZ-21		

BBR201P64014, BBR201P64016, BBR201P64018, BBR201P67814, BBR201P67816, BBR201P67818



BWSS12P3		
MTC-3-13-C1		
7800SM-34, 7800SM-36		
SL25L		
SR200-MM		
S240		

Fit&Go 3/3 Foam Laser Marked Inlay 1/2" Deep Socket & Socket Hex Bits Set - 49 pcs



FF1A219LM

35 x 445 x 543 mm 1 FF1A219LM

1-100-08-2-2		
S1612L		
S18HEX		
S18TORX		

Fit&Go 3/3 Foam Laser Marked Inlay Combination Spanner Set & Adjustable Spanner - 21 pcs



FF1A220LM

35 x 445 x 543 mm 1 FF1A220LM

111M-10, 111M-11, 111M-12, 111M-13, 111M-14, 111M-15, 111M-16, 111M-17, 111M-18, 111M-19, 111M-20, 111M-21, 111M-22, 111M-23, 111M-24, 111M-27, 111M-30, 111M-32, 111M-8, 111M-9		
8071		

Fit&Go 3/3 Foam Laser Marked Inlay Ratcheting Combination Spanner, Swivel Head Spanner & L-Keys Sets - 42 pcs



FF1A221LM

40 x 445 x 543 mm 1 FF1A221LM

1RM-10, 1RM-11, 1RM-12, 1RM-13, 1RM-14, 1RM-17, 1RM-19, 1RM-8		
2681		
4040M-10-11, 4040M-12-13, 4040M-14-15, 4040M-16-17, 4040M-18-19, 4040M-8-9		
8045LVDE		
806-1-1		
808050		
808050S		
9715-14-250		
BE-9575		
BE-9770		

Fit&Go 3/3 Foam Laser Marked Inlay ERGO™ Screwdrivers, Caliper, Bit Set & 1/2" Impact Socket Set - 65 pcs



FF1A222LM

45 x 445 x 543 mm 1 FF1A222LM

BE-7805, BE-7806, BE-7807, BE-7808, BE-7809, BE-7810, BE-7811, BE-7813, BE-7855		
D/S14		
K8160D-1, K8160D-2		
K8167S		
BE-8135TB, BE-8145TB, BE-8150TB, BE-8155TB		
BE-8610TB, BE-8620TB, BE-8623TB		
1150-1/2H/P		
59/S31B		



Fit&Go 3/3 Foam Laser Marked Inlay Pliers & T-Type Hex Key Spanners - 15 pcs



FF1A223LM

35 x 445 x 543 mm 1 FF1A223LM

5226 DC	
158-N	
158-NB	
21HDG-200	
2430 G-190HD	
2628G-200IP	
2968-190	
8224 IP	
BE1P	
BE1TH-2.5, BE1TH-3, BE1TH-4, BE1TH-5, BE1TH-6, BE1TH-8	

Fit&Go 3/3 Foam Laser Marked Inlay Striking, Cutting & Hose Clamp Set - 26 pcs



FF1A224LM

40 x 445 x 543 mm 1 FF1A224LM

1435/8	
319	
3625S-35	
3734S/6	
3735-5-150	
3740-200	
3750	
3906-300-24-2P	
479-16	
KBFU-01	
BE256P3	

Fit&Go 3/3 Foam Laser Marked Inlay Awls, Hooks, Scraper, Magnetic Pick Up Tool & Torx Bits Set - 60 pcs



FF1A225LM

40 x 445 x 543 mm 1 FF1A225LM

2487	
2535F1	
2633/S4	
2485	
782-U	
BE5049T	
BE66152	
2484-45	
5515T-52	

Fit&Go 3/3 Foam Inlay 1/4" + 1/2" Screwdriver/Socket Set - 77 Pcs



FF1A01

45 x 445 x 543 mm 1 FF1A01

A6800DM-4, A6800DM-5, A6800DM-6, A6800DM-7, A6800DM-8, A6800DM-9, A6800DM-10, A6800DM-11, A6800DM-12, A6800DM-13	
6700SM-4.5, 6700SM-5, 6700SM-5.5, 6700SM-6, 6700SM-7, 6700SM-8, 6700SM-9, 6700SM-10, 6700SM-11, 6700SM-12, 6700SM-13, 6700SM-4	
59S/22-1	
6950SL	
6954	
6956	
6960, 6961	
6966	
6972H	

7800SM-18, 7800SM-19, 7800SM-10, 7800SM-11, 7800SM-12, 7800SM-13, 7800SM-14, 7800SM-15, 7800SM-16, 7800SM-17, 7800SM-22, 7800SM-27, 7800SM-24, 7800SM-30, 7800SM-32

7805ZZ-21	
7807H	
B191.040.100, B191.055.150	
B192.001.100, B192.002.125	
8150SL	
8154-11	
8160-3, 8160-10	
8166	
6960-2	
6960-4	

Fit&Go 3/3 Foam Inlay Combination and Double Open End Wrench Set - 19 Pcs



FF1A02

45 x 445 x 543 mm 1 FF1A02

111M-12, 111M-13, 111M-14, 111M-17, 111M-19, 111M-22, 111M-6, 111M-7, 111M-8, 111M-10	
6M-6-7, 6M-8-9, 6M-10-11, 6M-12-13, 6M-14-15, 6M-16-17, 6M-18-19, 6M-20-22	
808050L	

Fit&Go 3/3 Foam Inlay Pliers/Striking/Measuring Toolset - 18 Pcs



FF1A03

50 x 445 x 543 mm 1 FF1A03

BE-9770	
MTB-5-25	
3734N-4-150, 3734N-6-150	
1-100-08-2-2	
2171G-160	
2971G-250	
481-400	
2678 G-160	
306	

Fit&Go 3/3 Foam Inlay Adjustable/Combination/Double Open End Wrench Set - 30 Pcs



FF1A04

50 x 445 x 543 mm 1 FF1A04

S4RM-12-15, S4RM-16-19, S4RM-8-11	
111M-30, 111M-32, 111M-6, 111M-7, 111M-8, 111M-9, 111M-10, 111M-11, 111M-12, 111M-13, 111M-14, 111M-15, 111M-16, 111M-17, 111M-18, 111M-19, 111M-21, 111M-22, 111M-24, 111M-27	
6M-10-11, 6M-12-13, 6M-14-15, 6M-17-19, 6M-6-7, 6M-8-9	
9071C	

Fit&Go 3/3 Foam Laser Marked Inlay 1/2" & 1/4" Sockets Ratcheting Screwdriver & Bit Set - 104 pcs



FF1A051

50 x 445 x 543 mm 1 FF1A051

BE-9678	
SBS60-4, SBS60-4.5, SBS60-5, SBS60-5.5, SBS60-6, SBS60-7, SBS60-8, SBS60-9, SBS60-10, SBS60-11, SBS60-12, SBS60-13, SBS60-14	
SBS61	
SBS63-2, SBS63-4, SBS63-6	
SBS65	
SBS67	
SBS69	
7800SM-10, 7800SM-11, 7800SM-12, 7800SM-13, 7800SM-14, 7800SM-15, 7800SM-16, 7800SM-18, 7800SM-19, 7800SM-21, 7800SM-17, 7800SM-22, 7800SM-24, 7800SM-27, 7800SM-32, 7800SM-30	
SBS88	
59S/31-1	
6956	
6972H	
7809M-5, 7809M-6, 7809M-7, 7809M-8, 7809M-10, 7809M-12, 7809M-14, 7809M-17, 7809M-19	
7809TORX-T20, 7809TORX-T25, 7809TORX-T27, 7809TORX-T30, 7809TORX-T40, 7809TORX-T45, 7809TORX-T50, 7809TORX-T55, 7809TORX-T60	
808050	
8150SL	
8154-11	
8160-W	
8160-10	
8166	
6954	

Fit&Go 3/3 Foam Inlay Screwdriver/Pliers Set - 23 Pcs



FF1A06

45 x 445 x 543 mm 1 FF1A06

BE-8020L, BE-8040	
BE-8150, BE-8255, BE-8256	
BE-8350	

BE-8601	
BE-8610, BE-8620	
BE-8910, BE-8915, BE-8920, BE-8925, BE-8927, BE-8930	
MTB-3-16	
2101G-160IP	
2427 G-200 IP	
2535L	
2628 G-160IP	
2951-180	
5515T-52	
8224 IP	

Fit&Go 3/3 Foam Inlay File/Striking Toolset with Hacksaw Frame - 15 Pcs



FF1A07

40 x 445 x 543 mm 1 FF1A07

3734N-3-150, 3734N-5-150, 3734N-6-150	
3735N-4-120	
3740-175	
SQZ150003	
1-100-08-2-2	
1-210-08-2-2	
1-230-08-2-2	
2744	
3625W-35	
3745-150	
481-400	
782-U	
317	



Fit&Go 3/3 Foam Inlay 1/4" + 1/2" + 3/8" Socket and Pear Head Ratchet Set - 138 Pcs



FF1A08

60 x 445 x 543 mm 1 FF1A08

A6800DM-5.5, A6800DM-6, A6800DM-7, A6800DM-8, A6800DM-9, A6800DM-10, A6800DM-11, A6800DM-12, A6800DM-13		
A7402DM-10, A7402DM-11, A7402DM-12, A7402DM-13, A7402DM-14, A7402DM-15, A7402DM-16, A7402DM-17, A7402DM-18, A7402DM-19		
1544		
2058-BR, 6954, 7764		
6700SM-5.5, 6700SM-6, 6700SM-7, 6700SM-8, 6700SM-9, 6700SM-10, 6700SM-11, 6700SM-12, 6700SM-13		
6709M-3, 6709M-4, 6709M-5, 6709M-6, 6709M-8		
6709PH-1, 6709PH-2, 6709PH-3		
6709TORX-T20, 6709TORX-T25, 6709TORX-T27, 6709TORX-T30, 6709TORX-T40, 6709TORX-T8, 6709TORX-T9, 6709TORX-T10, 6709TORX-T15		
6950SL		
6956		
6958		
6960, 6961, 6962, 6962L, 6960-6, 6960-14		
6966		
6972H		
7400SM-6, 7400SM-7, 7400SM-8, 7400SM-9, 7400SM-10, 7400SM-11, 7400SM-12, 7400SM-13, 7400SM-14, 7400SM-15, 7400SM-16, 7400SM-17, 7400SM-18, 7400SM-19, 7400SM-22		
7407H		
7409M-3, 7409M-4, 7409M-5, 7409M-6, 7409M-7, 7409M-8, 7409M-10		
7409TORX-T25, 7409TORX-T27, 7409TORX-T30, 7409TORX-T40, 7409TORX-T45, 7409TORX-T50		
7750SL		
7754, 7760, 7761		
7758		
7762, 7760-3, 7760-5		
7765		
7766		
7800SM-10, 7800SM-11, 7800SM-12, 7800SM-13, 7800SM-14, 7800SM-15, 7800SM-16, 7800SM-17, 7800SM-18, 7800SM-19, 7800SM-21, 7800SM-22, 7800SM-24, 7800SM-27, 7800SM-30, 7800SM-32		

7807H		
7809M-5, 7809M-6, 7809M-7, 7809M-8, 7809M-10, 7809M-12, 7809M-14, 7809M-17, 7809M-19		
7809TORX-T20, 7809TORX-T25, 7809TORX-T27, 7809TORX-T30, 7809TORX-T40, 7809TORX-T45, 7809TORX-T55, 7809TORX-T50, 7809TORX-T60		
8150SL		
8164-1/2		
8154-11		
8160-5, 8160-10		
8171		
8166		
8172		
6960-2, 6972		
6960-4		
7771		

Fit&Go 3/3 Foam Inlay Adjustable/Combination/Double Open End Wrench Set - 34 Pcs



FF1A09

50 x 445 x 543 mm 1 FF1A09

111M-30, 111M-32, 111M-6, 111M-7, 111M-8, 111M-9, 111M-10, 111M-11, 111M-12, 111M-13, 111M-14, 111M-15, 111M-16, 111M-17, 111M-18, 111M-19, 111M-21, 111M-22, 111M-24, 111M-27		
1320RM-10-11, 1320RM-12-13, 1320RM-8-9		
6M-6-7, 6M-8-9, 6M-10-11, 6M-12-13, 6M-14-15, 6M-16-17, 6M-18-19, 6M-20-22, 6M-24-27, 6M-30-32		
9071C		

Fit&Go 3/3 Foam Inlay T-Handle + L-Key Screwdriver Set - 19 Pcs



FF1A1004

38 x 445 x 543 mm 1 FF1A1004

900T-050-150, 900T-020-100, 900T-025-100, 900T-030-100, 900T-040-150, 900T-060-200, 900T-080-200, 900T-100-200		
BE-9777B		

Fit&Go 3/3 Hex/TORX T-Handle Screwdriver Set - 12 Pcs

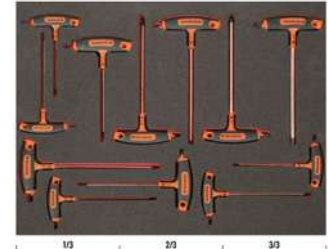

FF1A1011

35 x 445 x 543 mm 1 FF1A1011

903T-2		
903T-1		

Fit&Go 3/3 Foam Inlay Combination Wrenches and Pliers Set - 82 Pcs



FF1A102

40 x 445 x 543 mm 1 FF1A102

111M-32, 111M-8, 111M-9, 111M-10, 111M-11, 111M-12, 111M-13, 111M-14, 111M-15, 111M-16, 111M-17, 111M-18, 111M-19, 111M-21, 111M-22, 111M-24, 111M-27		
7224		
2800-180		
2900-180		
2890-180		
2990-180		
2101G-180		
2628 G-180IP		

Fit&Go 3/3 Foam Inlay Socket Set - 93 Pcs



FF1A106



55 x 543 x 445 mm

1 FF1A106

S87+7

Fit&Go 3/3 Foam Inlay Pliers Set - 16 Pcs



FF1A11



43 x 543 x 445 mm

1 FF1A11

2101GC-125IP, 2101GC-160IP

21HDGC-200IP

2427 GC-200IP

2430 GC-200 IP

2628 GC-160IP

2928-160, 2928-200, 2928-250

2951-250

2952-165

8224CIP

BFLA01

Fit&Go 3/3 Foam Inlay Striking and Cutting Toolset - 11 Pcs



FF1A110



50 x 445 x 543 mm

1 FF1A110

2535L

426TOR9

9572-200

MTB-8-25

SQZ150003

3875-LY3

479-24

481-400

529-20-L

225-PLUS

208

Fit&Go 3/3 Foam Inlay Wrench/Adjustable Wrench Set - 22 Pcs



FF1A112



35 x 445 x 543 mm

1 FF1A112

S4RM/3T

111M-6, 111M-7, 111M-8, 111M-9, 111M-10, 111M-11, 111M-12, 111M-13, 111M-14, 111M-15, 111M-16, 111M-17, 111M-18, 111M-19, 111M-20, 111M-21, 111M-22, 111M-24, 111M-27

9031

9070

Fit&Go 3/3 Foam Inlay Pliers and Striking Toolset - 18 Pcs



FF1A114



42 x 445 x 543 mm

1 FF1A114

8224 IP

2632

3734-2, 3734-3, 3734-4, 3734-5, 3734-6, 3734-8

2800-180

2890-180

2900-180

2990-180

4611-2

479-24

1435/5

1178-SCRIBE

2430 G-160 IP

2101G-180IP

Fit&Go 3/3 Foam Inlay Measuring and Cutting Toolset - 9 Pcs



FF1A115



35 x 445 x 543 mm

1 FF1A115

1-210-08-1-2

9045-B-250

406T-225

MTB-5-25

BFLA01

K-AP-1

268

5515T-52

319



Fit&Go 3/3 Foam Inlay Wrench and Screwdriver Set - 26 Pcs



FF1A117

35 x 445 x 543 mm 1 FF1A117

B191.040.100	
B190.055.125, B190.065.150	
B192.000.075, B192.001.100, B192.002.125	
111M-32, 111M-6, 111M-7, 111M-8, 111M-9, 111M-10, 111M-11, 111M-12, 111M-13, 111M-14, 111M-15, 111M-16, 111M-17, 111M-18, 111M-19, 111M-21, 111M-22, 111M-24, 111M-27	
8073 IP	

Fit&Go 3/3 Foam Inlay Striking and File Set - 19 Pcs



FF1A12

35 x 445 x 543 mm 1 FF1A12

FS-8	
1-100-06-1-2, 1-100-06-2-2	
1-160-06-1-2	
1-210-06-1-2	
1-230-06-1-2	
2509	
2535F2	
3625W-35	
3734-3, 3734-5, 3734-8	
3735-4-120	
3740-150	
3745-150	
481-300, 481-500	
319	
8157-15	

Fit&Go 3/3 Foam Inlay Wrench/Pliers Set - 28 Pcs



FF1A121

40 x 445 x 543 mm 1 FF1A121

111M-8, 111M-9, 111M-10, 111M-11, 111M-12, 111M-13, 111M-14, 111M-15, 111M-16, 111M-17, 111M-18, 111M-19, 111M-22	
2470 G-200	
7224	
2953-250	
6M-6-7, 6M-8-9, 6M-10-11, 6M-12-13, 6M-14-15, 6M-16-17, 6M-18-19, 6M-20-22	
2800-180	
2900-180	
2101G-160IP	

Fit&Go 3/3 Foam Inlay Wrench/Screwdriver Set - 25 Pcs



FF1A124

45 x 445 x 543 mm 1 FF1A124

B191.040.100	
B190.055.125, B190.065.150	
B192.000.075, B192.001.100, B192.002.125	
111M-32, 111M-6, 111M-7, 111M-8, 111M-9, 111M-10, 111M-11, 111M-12, 111M-13, 111M-14, 111M-15, 111M-16, 111M-17, 111M-18, 111M-19, 111M-21, 111M-22, 111M-24, 111M-27	

Fit&Go 3/3 Foam Inlay Striking/Cutting Toolset - 11 Pcs

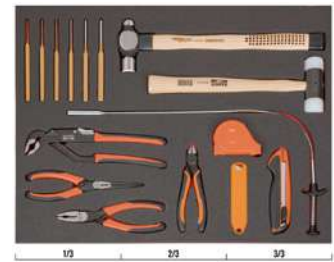

FF1A127

35 x 445 x 543 mm 1 FF1A127

3734S/6	
479-16	
3625W-35	
MTG-3-16	
KB18-01	
KSBG18-10DISPEN	
8224 IP	
2101G-160IP	
2628 G-180IP	
2430 G-200 IP	
2530	

Fit&Go 3/3 Foam Inlay 1/4" + 3/8" Socket and Pear Head Ratchet Set - 83 Pcs



FF1A13

55 x 445 x 543 mm 1 FF1A13

A6700DZ-1/2, A6700DZ-1/4, A6700DZ-11/32, A6700DZ-3/16, A6700DZ-3/8, A6700DZ-5/16, A6700DZ-7/16, A6700DZ-7/32, A6700DZ-9/16, A6700DZ-9/32	
A6710DZ-1/2, A6710DZ-1/4, A6710DZ-11/32, A6710DZ-3/16, A6710DZ-3/8, A6710DZ-5/16, A6710DZ-7/16, A6710DZ-7/32, A6710DZ-9/16, A6710DZ-9/32	
A6800DM-4, A6800DM-10	
A6800DZ-1/2, A6800DZ-1/4, A6800DZ-11/32, A6800DZ-3/16, A6800DZ-3/8, A6800DZ-5/16, A6800DZ-7/16, A6800DZ-7/32, A6800DZ-9/16, A6800DZ-9/32	

A7400DZ-1/2, A7400DZ-1/4, A7400DZ-11/16, A7400DZ-13/16, A7400DZ-17/32, A7400DZ-19/32, A7400DZ-3/4, A7400DZ-3/8, A7400DZ-5/16, A7400DZ-5/8, A7400DZ-7/16, A7400DZ-7/8, A7400DZ-9/16		
A7402DZ-1/2, A7402DZ-1/4, A7402DZ-11/16, A7402DZ-13/16, A7402DZ-19/32, A7402DZ-3/4, A7402DZ-3/8, A7402DZ-5/8, A7402DZ-7/16, A7402DZ-7/8, A7402DZ-9/16		
6700SZ-5/32		
6950SL		
6954, 7764		
6956		
6958		
6960, 6961, 6962, 6962L, 6960-6, 6960-14		
6966		
6972H		
7407H, 7408H		
7750SL		
7752		
7754, 7760, 7761		
7758		
7762, 7760-3, 7760-5		
7765		
7766		
8164-1/2		
U-S6106KA, 6960-4		
8171		
6960-2, 6972		
7771		

Fit&Go 3/3 Foam Inlay Socket/Bit Set - 53 Pcs



FF1A130

45 x 445 x 543 mm 1 FF1A130

7800SM-8, 7800SM-9, 7800SM-10, 7800SM-11, 7800SM-12, 7800SM-13, 7800SM-14, 7800SM-15, 7800SM-16, 7800SM-17, 7800SM-18, 7800SM-19, 7800SM-21, 7800SM-22, 7800SM-23, 7800SM-24, 7800SM-27, 7800SM-30, 7800SM-32		
8150SL		
SBS87S, SBS87, 8158-10, 8158-15		
SBS83-3, SBS83-5, SBS83-10		
SBS85		
SBS86		
SBS88		
SBS89		

7809TORX-T20, 7809TORX-T25, 7809TORX-T27, 7809TORX-T30, 7809TORX-T40, 7809TORX-T45, 7809TORX-T50, 7809TORX-T55, 7809TORX-T60		
7809M-5, 7809M-6, 7809M-7, 7809M-8, 7809M-9, 7809M-10, 7809M-12, 7809M-14, 7809M-17, 7809M-19		
7809M-5-180, 7809M-6-140, 7809M-7-100, 7809M-8-120, 7809M-10-140		

Fit&Go 3/3 Foam Inlay Mixed Tightening/Measuring Toolset - 10 Pcs



FF1A131

40 x 445 x 543 mm 1 FF1A131

SQZ150003		
FS-8		
SQZ150003-SBL		
481-400		
3734-2, 3734-4, 3734-5, 3734-6, 3734-8, 3734-3		
3735-5-120		
3740-175		
BE-9678		
1547		
319		
208		
3625N-32		

Fit&Go 3/3 Foam Inlay Mixed Sockets/File Set - 31 Pcs



FF1A132

40 x 445 x 543 mm 1 FF1A132

7400SM-6, 7400SM-7, 7400SM-8, 7400SM-9, 7400SM-10, 7400SM-11, 7400SM-12, 7400SM-13, 7400SM-14, 7400SM-15, 7400SM-16, 7400SM-17, 7400SM-18, 7400SM-19		
--	--	--

7750SL		
SBS705		
SBS755		
SBS723, SBS724		
SBS775		
SBS760, SBS761, SBS762		
1-100-08-1-2		
1-160-08-1-2		
1-170-08-2-2		
1-210-08-1-2		
1-230-08-1-2		
2635		
1150D		
2681		

Fit&Go 3/3 Foam Inlay Screwdriver Set - 17 Pcs



FF1A133

35 x 445 x 543 mm 1 FF1A133

900T-020-100, 900T-025-100, 900T-030-100, 900T-040-150, 900T-050-150, 900T-060-200, 900T-080-200, 900T-100-200		
B194.006.075, B194.007.075, B194.008.075, B194.009.075, B194.010.075, B194.015.100, B194.020.100, B194.025.125, B194.030.150		

Fit&Go 3/3 Foam Inlay Combination Wrench Set - 21 Pcs



FF1A134

37 x 445 x 543 mm 1 FF1A134

111M-30, 111M-32, 111M-6, 111M-7, 111M-8, 111M-9, 111M-10, 111M-11, 111M-12, 111M-13, 111M-14, 111M-15, 111M-16, 111M-17, 111M-18, 111M-19, 111M-20, 111M-21, 111M-22, 111M-24, 111M-27		
---	--	--



Fit&Go 3/3 Foam Inlay Wrench/Bit Set - 51 Pcs



FF1A135



40 x 445 x 543 mm

1 FF1A135

4040M-8-9, 4040M-10-11, 4040M-12-13, 4040M-14-15, 4040M-16-17, 4040M-18-19, 4040M-20-22, 4040M-21-23



59S/31-1



6M-6-7, 6M-8-9, 6M-10-11, 6M-12-13, 6M-14-15, 6M-16-17, 6M-18-19, 6M-20-22, 6M-21-23, 6M-24-27, 6M-25-28, 6M-30-32



Fit&Go 3/3 Foam Inlay 1/4" Socket/Pliers/Screwdriver Set - 40 Pcs



FF1A136



40 x 445 x 543 mm

1 FF1A136

2628 G-180



2430 G-160



8224



2101G-160



6700SM-4.5, 6700SM-5, 6700SM-5.5, 6700SM-6, 6700SM-7, 6700SM-8, 6700SM-9, 6700SM-10, 6700SM-11, 6700SM-12, 6700SM-13, 6700SM-14, 6700SM-4



6950SL

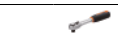

SBS67

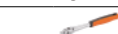

SBS69

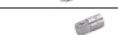

BAHCO

SBS65



SBS63-2, SBS63-4, SBS63-6



2800-180

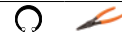

2890-180



2900-180



2990-180



B191.030.075, B191.040.100



B190.055.100, B190.065.125, B190.080.150



B195.050.025



B195.001.025



B192.001.100, B192.002.125



808050



6954

Fit&Go 3/3 Foam Inlay Socket and Round Head Ratchet Set - 59 Pcs



FF1A137



50 x 445 x 543 mm

1 FF1A137

7800SM-8, 7800SM-9, 7800SM-10, 7800SM-11, 7800SM-12, 7800SM-13, 7800SM-14, 7800SM-15, 7800SM-16, 7800SM-17, 7800SM-18, 7800SM-19, 7800SM-21, 7800SM-22, 7800SM-23, 7800SM-24, 7800SM-27, 7800SM-30, 7800SM-32

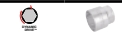

8150SL



SBS87S, SBS87, 8158-10, 8158-15



SBS83-3, SBS83-5, SBS83-10



SBS85

SBS86, 6954

SBS88

SBS89



7809TORX-T50, 7809TORX-T20, 7809TORX-T25, 7809TORX-T27, 7809TORX-T30, 7809TORX-T40, 7809TORX-T45, 7809TORX-T55, 7809TORX-T60



6700SM-4, 6700SM-4.5, 6700SM-5, 6700SM-5.5, 6700SM-6, 6700SM-7, 6700SM-8, 6700SM-9, 6700SM-10, 6700SM-11, 6700SM-12, 6700SM-13, 6700SM-14



6950SL



SBS67



SBS69



SBS65



SBS63-2, SBS63-4, SBS63-6



Fit&Go 3/3 Foam Inlay Mixed Striking/Cutting Toolset - 16 Pcs



FF1A138



40 x 445 x 543 mm

1 FF1A138

SQZ150003



FS-8



SQZ150003-SBL



481-400



3734-2, 3734-3, 3734-4, 3734-5, 3734-6, 3734-8



3735-5-120



3740-175



BE-9678



319



208



3625N-32



Fit&Go 3/3 Foam Inlay Screwdriver Set - 18 Pcs



FF1A139



38 x 445 x 543 mm

1 FF1A139

808050



900T-020-100, 900T-025-100, 900T-030-100, 900T-040-150, 900T-050-150, 900T-060-200, 900T-080-200, 900T-100-200



B191.030.075, B191.040.100



B190.055.100, B190.065.125, B190.080.150

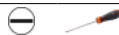

B195.050.025



B195.001.025



B192.001.100, B192.002.125



Fit&Go 3/3 Foam Inlay Imperial Combination and Double Open End Wrench Set - 43 Pcs



FF1A14

46 x 445 x 543 mm 1 FF1A14

111Z-1, 111Z-1/2, 111Z-1/4, 111Z-11/16, 111Z-13/16, 111Z-15/16, 111Z-3/4, 111Z-3/8, 111Z-5/16, 111Z-5/8, 111Z-7/16, 111Z-7/8, 111Z-9/16	
1320RZ-1/2-9/16, 1320RZ-1/4-5/16, 1320RZ-3/8-7/16, 1320RZ-5/16-11/32	
1931Z-1/2, 1931Z-1/4, 1931Z-11/32, 1931Z-3/16, 1931Z-3/8, 1931Z-5/16, 1931Z-5/32, 1931Z-7/16, 1931Z-7/32, 1931Z-9/16, 1931Z-9/32	
1950MZ-3/8	
1952Z-11/32	
6Z-1.1/16-1.1/4, 6Z-1-1.1/8, 6Z-1/2-9/16, 6Z-1/4-5/16, 6Z-15/16-1, 6Z-19/32-11/16, 6Z-25/32-13/16, 6Z-3/8-7/16, 6Z-5/16-11/32, 6Z-5/8-3/4, 6Z-7/8-15/16	
8069 C IP	
9070C	

Fit&Go 3/3 Foam Inlay Mixed Wrench/Pliers Set - 46 Pcs

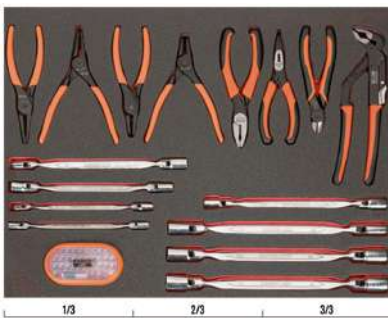

FF1A141

42 x 445 x 543 mm 1 FF1A141

2628 G-180	
2430 G-160	
8224	
2101G-160	
2800-180	

2890-180	
2900-180	
2990-180	
4040M-8-9, 4040M-10-11, 4040M-12-13, 4040M-14-15, 4040M-16-17, 4040M-18-19, 4040M-20-22, 4040M-21-23	
59S/31-1	

Fit&Go 3/3 Foam Inlay Mixed Striking/Cutting Toolset - 15 Pcs



FF1A143

45 x 445 x 543 mm 1 FF1A143

SQZ150003	
FS-8	
SQZ150003-SBL	
MTB-5-25	
481-400	
3734-2, 3734-3, 3734-4, 3734-5, 3734-6, 3734-8	
3735-5-120	
3740-175	
319	
208	
3625N-32	

Fit&Go 3/3 Foam Inlay Screwdriver/File/Pliers Set - 20 Pcs



FF1A145

38 x 445 x 543 mm 1 FF1A145

2628 G-180	
2430 G-160	
8224	
2101G-160	
2800-180	

2628 G-180	
2430 G-160	
8224	
2101G-160	
8045LVDE	
808050	
613-3-75	
611-4-100, 611-5.5-100, 611-6.5-150, 611-8-150, 611-6.5-25	
615-1-100, 615-2-125, 615-2-25	
1-100-08-1-2	
1-160-08-1-2	
1-170-08-2-2	
1-210-08-1-2	
1-230-08-1-2	

Fit&Go 3/3 Foam Inlay 1/2" Socket/Pliers Set - 34 Pcs



FF1A146

50 x 445 x 543 mm 1 FF1A146

2628 G-180	
2430 G-160	
8224	
2101G-160	
FS-8	
7800SM-8, 7800SM-9, 7800SM-10, 7800SM-11, 7800SM-12, 7800SM-13, 7800SM-14, 7800SM-15, 7800SM-16, 7800SM-17, 7800SM-18, 7800SM-19, 7800SM-21, 7800SM-22, 7800SM-23, 7800SM-24, 7800SM-27, 7800SM-30, 7800SM-32	
8150SL	
SBS87S, SBS87, 8158-10, 8158-15	
8160-3, 8160-5, 8160-10	
8166	
8154-11	
8171	
8172	



Fit&Go 3/3 Foam Inlay Cutters and Pliers Set - 12 Pcs



FF1A15



40 x 445 x 543 mm

1 FF1A15

2101GC-125IP, 2101GC-160IP	
2233D-240IP	
2421GC-180IP	
2427 GC-200IP	
2430 GC-200 IP	
2628 GC-160IP	
2650	
2855, 2855 D	
2951-180	
8224CIP	

Fit&Go 3/3 Foam Inlay 1/4" & 1/2" Socket Set and Wrenches - 94 Pcs



FF1A153



335 x 445 x 543 mm

1 FF1A153

S87+7

Fit&Go 3/3 Foam Inlay Mixed Toolset - 18 Pcs



FF1A16



40 x 445 x 543 mm

1 FF1A16

KE18-01	
1150-1/2H/P	
MTB-3-16	
1177-SCRIBE	
1544	
2509	
2535F2	
2632	
268	
2744	
2820EF2	
3525HB	
5471 F-145	
5515T	
5515T-52	
5516	
BFLA01	
SR300-E	

Fit&Go 3/3 Foam Inlay Cutting Tools, Files & Impact Driver Set - 36 pcs



FF1A168



40 x 445 x 543 mm

1 FF1A168

1-100-08-2-2	
1-210-08-2-2	
1-230-08-2-2	

2485	
2487	
319	
268	
3740-100, 3740-150	
5515T	
782-U	
7865	
KB18-01	
KSBG18-10DISPEN	

Fit&Go 3/3 Foam Inlay Metric Double Head Offset Socket Spanners Set - 14 pcs



FF1A170



40 x 445 x 543 mm

1 FF1A170

28M-16, 28M-15, 28M-18, 28M-17, 28M-12, 28M-11, 28M-14, 28M-13, 28M-24, 28M-19, 28M-22, 28M-8, 28M-10, 28M-9	
--	--

Fit&Go 3/3 Foam Inlay Striking/File Set - 24 Pcs



FF1A18



44 x 445 x 543 mm

1 FF1A18

1-476-04-3-2	
2633/S4	
3734S/6	
3736S/6	
481-200, 481-500	
782-U	
3625N-32	

Fit&Go 3/3 Foam Inlay Striking, Cutting & Pliers - 15 Pcs



FF1A185



40 x 445 x 543 mm 1 FF1A185

3734S/6-T	
479-16	
3625W-35	
KB18-01	
KSBG18-10DISPEN	
2101G-180IP	
2470 G-200	
2678 G-180	
8224 IP	
2530	

Fit&Go 3/3 Foam Inlay Adjustable/Combination/Double Open End Wrench Set - 33 Pcs



FF1A19



50 x 543 x 445 mm 1 FF1A19

111M-30, 111M-32, 111M-6, 111M-7, 111M-8, 111M-9, 111M-10, 111M-11, 111M-12, 111M-13, 111M-14, 111M-15, 111M-16, 111M-17, 111M-18, 111M-19, 111M-20, 111M-21, 111M-22, 111M-24, 111M-27	
6M-6-7, 6M-8-9, 6M-10-11, 6M-12-13, 6M-14-15, 6M-16-17, 6M-18-19, 6M-20-22, 6M-21-23, 6M-24-27, 6M-30-32	
92C	

Fit&Go 3/3 Foam Inlay 1/2" & 1/4" Socket Set & Torque Wrench - 51 pcs



FF1A194



40 x 445 x 543 mm 1 FF1A194

6968	
6700SM-14, 6700SM-13, 6700SM-12, 6700SM-11, 6700SM-10, 6700SM-9, 6700SM-8, 6700SM-7, 6700SM-6, 6700SM-5, 6700SM-4	
6709M-3, 6709M-8, 6709M-6, 6709M-5, 6709M-4	
6950SL	
7800SM-24, 7800SM-23, 7800SM-22, 7800SM-13, 7800SM-12, 7800SM-11, 7800SM-10, 7800SM-9, 7800SM-8, 7800SM-21, 7800SM-19, 7800SM-18, 7800SM-17, 7800SM-16, 7800SM-15, 7800SM-14	
7809M-8, 7809M-7, 7809M-10, 7809M-6, 7809M-5	
7809TORX-T20, 7809TORX-T25, 7809TORX-T30, 7809TORX-T40	
7455-200	
8150SL	
8168	
K6650-1/4-1P	
6960W-2, 6960W-6	
8160-10, 8160-5	

Fit&Go 3/3 Foam Inlay Double Ring End/Double Socket Head Ratchet Set - 18 Pcs



FF1A20



50 x 445 x 543 mm 1 FF1A20

6958	
6954	
6960, 6962, 6960-6	
6966	
6950SL	
4532-A	
8157-15	
8154-11	
8160-3, 8160-5	
8166	
6960-2	

2M-6-7, 2M-8-9, 2M-10-11, 2M-12-13, 2M-14-15, 2M-16-17, 2M-18-19, 2M-20-22, 2M-21-23, 2M-24-27, 2M-30-32	
4040M-10-11, 4040M-12-13, 4040M-14-15, 4040M-16-17, 4040M-18-19, 4040M-21-23	
2953-250	

Fit&Go 3/3 Foam Inlay Puller/Round Head Ratchet/Socket Set - 58 Pcs



FF1A22



50 x 445 x 543 mm 1 FF1A22

7800SM-10, 7800SM-12, 7800SM-13, 7800SM-14, 7800SM-16, 7800SM-17, 7800SM-18, 7800SM-19, 7800SM-21, 7800SM-22, 7800SM-23, 7800SM-24, 7800SM-27, 7800SM-30, 7800SM-32	
7805SM-13, 7805SM-16, 7805SM-17, 7805SM-18, 7805SM-19, 7805SM-21, 7805SM-22, 7805SM-24, 7805SM-27, 7805SM-30, 7805SM-32	
7809M-5, 7809M-6, 7809M-8, 7809M-10, 7809M-12, 7809M-14	
8150SL	
6700SM-4, 6700SM-4.5, 6700SM-5, 6700SM-5.5, 6700SM-6, 6700SM-7, 6700SM-8, 6700SM-9, 6700SM-10, 6700SM-11, 6700SM-12, 6700SM-13	
6958	
6954	
6960, 6962, 6960-6	
6966	
6950SL	
4532-A	
8157-15	
8154-11	
8160-3, 8160-5	
8166	
6960-2	



Fit&Go 3/3 Foam Inlay Measuring Tape/
Striking/Pliers Set - 21 Pcs



FF1A23

40 x 445 x 543 mm		1	FF1A23

3735-4-120	
3734-2, 3734-3, 3734-4, 3734-5, 3734-6, 3734-8	
2630GC-180IP	
2430 GC-200 IP	
2427 GC-200IP	
2900-180	
2890-180	
2990-180	
2800-180	
7224	
2101GC-160IP	
479-16	
1547	
MTB-3-16	
SC127	
3625N-32	

Fit&Go 3/3 Foam Inlay Circlip Pliers &
Spanners Set - 17 pcs



FF1A230

40 x 445 x 543 mm		1	FF1A230

1RM-9, 1RM-8, 1RM-11, 1RM-10, 1RM-13, 1RM-12, 1RM-15, 1RM-14, 1RM-17, 1RM-16, 1RM-19, 1RM-18		
28-29/S4		
8072 C		

Fit&Go 3/3 Foam Inlay 3/4" Socket Set -
26 Pcs



FF1A2301

70 x 445 x 543 mm		1	FF1A2301

8900DM-19, 8900DM-22, 8900DM-23, 8900DM-24, 8900DM-25, 8900DM-26, 8900DM-27, 8900DM-28, 8900DM-29, 8900DM-30, 8900DM-32, 8900DM-33, 8900DM-34, 8900DM-36, 8900DM-41, 8900DM-46, 8900DM-50, 8900DM-55, 8900DM-60		
8954, 8954-15		
8954A		
8958A		
8961		
8965, 8971		
8966		
8955N/B		
8957A		
8960-8		

Fit&Go 3/3 Laser Marked Foam Inlay with
Automotive Plug Socketry - 31 pcs



FF1A235

50 x 445 x 543 mm	4.10 kg	1	FF1A235

BE61110	
BE621702, BE621703, BE621701, BE621706, BE621707, BE621704, BE621705, BE621710, BE621711, BE621708, BE621709, BE621714, BE621715, BE621712, BE621713, BE621716, BE621717	
BE6810	
2M-6-7, 2M-8-9, 2M-12-13, 2M-18-19, 2M-16-17, 2M-10-11, 2M-14-15, 2M-24-26, 2M-21-23, 2M-27-29, 2M-20-22, 2M-30-32	

Fit&Go 3/3 Laser Marked Foam Inlay for
Automotive Body Shop - 13 pcs



FF1A236

55 x 445 x 543 mm	9.5 kg	1	FF1A236

3-330-14-2-0	
9-462-14-0-0	
1467-250	
BBSH2F	
BBSH2CA	
BBSDW	
BBSDA	
BBSDT	
BBSDH	
BBSDC	
BBSDHR	
BBSS1	
2485	





Fit&Go 3/3 Foam Inlay Measuring Tape/
Striking/Pliers Set - 19 Pcs



FF1A24

45 x 445 x 543 mm		1	FF1A24

3735-4-120	
3734-2, 3734-3, 3734-4, 3734-5, 3734-6, 3734-8	
2630GC-180IP	
2430 GC-200 IP	
2900-180	
2890-180	
2990-180	
2800-180	
7224	
2101GC-160IP	



























479-16	
3625N-32	
MTB-3-16	
SC127	

Fit&Go 3/3 Foam Inlay Socket and Round Head Ratchet Set - 50 Pcs



FF1A25

   50 x 445 x 543 mm 1 FF1A25

























































7800SM-10, 7800SM-12, 7800SM-13, 7800SM-14, 7800SM-15, 7800SM-16, 7800SM-17, 7800SM-18, 7800SM-19, 7800SM-21, 7800SM-22, 7800SM-23, 7800SM-24, 7800SM-27, 7800SM-30, 7800SM-32		
7805SM-13, 7805SM-16, 7805SM-17, 7805SM-18, 7805SM-19, 7805SM-21, 7805SM-22, 7805SM-24, 7805SM-27, 7805SM-30, 7805SM-32		
8150SL		
6700SM-4, 6700SM-4.5, 6700SM-5, 6700SM-5.5, 6700SM-6, 6700SM-7, 6700SM-8, 6700SM-9, 6700SM-10, 6700SM-11, 6700SM-12, 6700SM-13		
6954		
6960, 6962, 6960-6		
6966		
6950SL		
2953-250		
8166		
8154-11		
8160-3, 8160-5		
6960-2		

Fit&Go 3/3 Foam Inlay 1/4" + 1/2" + 3/8" Socket and Pear/Round Head Ratchet Set - 83 Pcs



FF1A2501

   50 x 445 x 543 mm 1 FF1A2501



































6700SM-4, 6700SM-5, 6700SM-5.5, 6700SM-6, 6700SM-7, 6700SM-8, 6700SM-9, 6700SM-10, 6700SM-11, 6700SM-12, 6700SM-13		
6700TORX-E8, 6700TORX-E10		
6709M-3, 6709M-4, 6709M-5, 6709M-6, 6709M-8		
6709TORX-T8, 6709TORX-T10, 6709TORX-T15, 6709TORX-T20, 6709TORX-T25, 6709TORX-T27, 6709TORX-T30, 6709TORX-T40		
6950SL		
6954, 7764		
6956		
6962, 6960-6		
6966		
7400SM-8, 7400SM-9, 7400SM-10, 7400SM-11, 7400SM-12, 7400SM-13, 7400SM-14, 7400SM-15, 7400SM-16, 7400SM-17, 7400SM-18, 7400SM-19, 7400SM-20, 7400SM-21, 7400SM-22		
7400TORX-E8, 7400TORX-E10, 7400TORX-E12, 7400TORX-E14		
7750SL		
7754		
7762		
7765		
7766		
7768		
7800SM-13, 7800SM-17, 7800SM-12, 7800SM-18, 7800SM-19, 7800SM-20, 7800SM-27, 7800SM-30, 7800SM-32, 7800SM-21, 7800SM-22, 7800SM-24		
7809M-12, 7809M-10		
7809TORX-T20, 7809TORX-T25, 7809TORX-T40, 7809TORX-T50, 7809TORX-T55		
8150SL		
8164-1/2		
8154-11		
8160-10		
8171		
8166		
8172		
7771		
6972		

Fit&Go 3/3 Foam Inlay 1/2"-3/8" Socket Set - 101 Pcs



FF1A2503

   55 x 445 x 543 mm 1 FF1A2503















6700SM-4.5, 6700SM-4, 6700SM-5, 6700SM-5.5, 6700SM-6, 6700SM-7, 6700SM-8, 6700SM-9, 6700SM-10, 6700SM-11, 6700SM-12, 6700SM-13, 6700SM-14		
7800SM-10, 7800SM-11, 7800SM-12, 7800SM-13, 7800SM-14, 7800SM-15, 7800SM-18, 7800SM-19, 7800SM-21, 7800SM-22, 7800SM-23, 7800SM-24, 7800SM-30, 7800SM-26, 7800SM-27, 7800SM-28, 7800SM-32, 7800SM-16, 7800SM-17, 7800SM-8, 7800SM-9		
BE-9678		
7809M-10, 7809M-12, 7809M-14, 7809M-17, 7809M-19, 7809M-5, 7809M-7, 7809M-8, 7809M-9, 7809M-6		
59S/31-1		
7809M-10-140, 7809M-5-180, 7809M-6-140, 7809M-7-100, 7809M-8-120		
808050		
8155-1/2		
6950		
6954		
6956		
6960, 6962, 6960-6		
6966		
8154-11		
8160-5, 8160-10		
8166		
6960-2		

Fit&Go 3/3 Foam Inlay Pliers and Wrench Set - 27 Pcs



FF1A26

   50 x 445 x 543 mm 1 FF1A26

111M-30, 111M-32, 111M-6, 111M-7, 111M-8, 111M-9, 111M-10, 111M-11, 111M-12, 111M-13, 111M-14, 111M-15, 111M-16, 111M-17, 111M-18, 111M-19, 111M-20, 111M-21, 111M-22, 111M-24, 111M-27		
2630GC-180IP		
2430 GC-200 IP		
7224		
2953-250		
2101GC-160IP		
SC127		



Fit&Go 3/3 Foam Inlay Socket and Striking Set - 48 Pcs



FF1A28

50 x 445 x 543 mm 1 FF1A28

- 7800SM-18, 7800SM-19, 7800SM-21, 7800SM-22, 7800SM-23, 7800SM-24, 7800SM-27, 7800SM-30, 7800SM-32, 7800SM-10, 7800SM-12, 7800SM-13, 7800SM-14, 7800SM-15, 7800SM-16, 7800SM-17
- 8150SL
- 6700SM-4.5, 6700SM-5, 6700SM-5.5, 6700SM-6, 6700SM-7, 6700SM-8, 6700SM-9, 6700SM-10, 6700SM-11, 6700SM-12, 6700SM-13, 6700SM-4
- 6954
- 6960, 6962, 6960-6
- 6966
- 6950SL
- 3735-4-120
- 3734-2, 3734-3, 3734-4, 3734-5, 3734-6, 3734-8
- 479-16
- MTB-3-16
- 3625N-32
- 8154-11
- 8160-3, 8160-5
- 8166
- 6960-2

Fit&Go 3/3 Foam Inlay Combination Ratcheting Wrench Set - 7 Pcs



FF1A3002

35 x 445 x 543 mm 1 FF1A3002

- 1RM-24, 1RM-22, 1RM-21, 1RM-19, 1RM-32, 1RM-30, 1RM-27

Fit&Go 3/3 Foam Inlay Combination Offset Wrench Set - 28 Pcs



FF1A3003

40 x 445 x 543 mm 1 FF1A3003

- 1952M-27, 1952M-21, 1952M-20, 1952M-19, 1952M-18, 1952M-24, 1952M-22, 1952M-13, 1952M-12, 1952M-11, 1952M-10, 1952M-17, 1952M-16, 1952M-15, 1952M-14, 1952M-9, 1952M-8, 1952M-7, 1952M-6

BE-9778

Fit&Go 3/3 Foam Inlay Combination Wrench Set - 21 Pcs



FF1A3001

40 x 445 x 543 mm 1 FF1A3001

- 111M-32, 111M-30, 111M-24, 111M-22, 111M-27, 111M-17, 111M-16, 111M-15, 111M-14, 111M-21, 111M-20, 111M-19, 111M-18, 111M-9, 111M-8, 111M-7, 111M-6, 111M-13, 111M-12, 111M-11, 111M-10

Fit&Go 3/3 Foam Inlay Standard Combination and Ratcheting Wrench Set - 30 Pcs



FF1A3004

48 x 445 x 543 mm 1 FF1A3004

- 111M-24, 111M-22, 111M-17, 111M-16, 111M-15, 111M-14, 111M-21, 111M-20, 111M-19, 111M-18, 111M-9, 111M-8, 111M-7, 111M-6, 111M-13, 111M-12, 111M-11, 111M-10

- 1RM-19, 1RM-10, 1RM-9, 1RM-8, 1RM-14, 1RM-13, 1RM-12, 1RM-11, 1RM-18, 1RM-17, 1RM-16, 1RM-15

Fit&Go 3/3 Foam Inlay Offset Combination and Ratcheting Wrench Set - 28 Pcs



FF1A3005

38 x 445 x 543 mm 1 FF1A3005

- 1952M-19, 1952M-18, 1952M-22, 1952M-13, 1952M-12, 1952M-11, 1952M-10, 1952M-17, 1952M-16, 1952M-15, 1952M-14, 1952M-9, 1952M-8, 1952M-7, 1952M-6

- 1RM-6, 1RM-10, 1RM-9, 1RM-8, 1RM-7, 1RM-24, 1RM-22, 1RM-19, 1RM-14, 1RM-13, 1RM-12, 1RM-11, 1RM-17

Fit&Go 3/3 Foam Inlay Screwdriver/Bit/Socket Set - 89 Pcs



FF1A36

50 x 445 x 543 mm 1 FF1A36

- 4040M-8-9, 4040M-10-11, 4040M-12-13, 4040M-14-15, 4040M-16-17

- 808050S

- 808050

- 6972H

- K6650-1/4-1P, 59S/H8, SB6963

- 6950SL

- 59S/31-1

- 59S/H2, 59S/H3, 59S/H4, 59S/H5, 59S/H6

8030-2P, 8040-2P, 8242-2P, 8252-2P		
8610-2P, 8620-2P, 8630-2P		
8810-2P, 8820-2P, 8830-2P		
8910-2P, 8915-2P, 8925-2P, 8930-2P, 8940-2P		
BE-8575		
SBS60-11, SBS60-12, SBS60-13, SBS60-4, SBS60-4.5, SBS60-5, SBS60-5.5, SBS60-6, SBS60-7, SBS60-8, SBS60-9, SBS60-10		
SBS64		

2421 G-140IP, 2421 G-180 IP		
2427 G-200 IP		
2628 G-180IP		
2681		
2951-140, 2951-300		
8224 IP		

Fit&Go 3/3 Foam Inlay Spanners Set - 31 pcs 



Fit&Go 3/3 Foam Inlay Socket and Wrench Set - 46 Pcs 



FF1A37
35 x 445 x 543 mm 1 FF1A37 

Fit&Go 3/3 Foam Inlay Pliers Set - 11 Pcs 





FF1A4002
42 x 445 x 543 mm 1 FF1A4002 

FF1A48
44 x 543 x 445 mm 1 FF1A48 

111M-6, 111M-7, 111M-8, 111M-9, 111M-10, 111M-11, 111M-12, 111M-13, 111M-14, 111M-15, 111M-16, 111M-17, 111M-18, 111M-19, 111M-21, 111M-22, 111M-24		
8071 IP		
2101G-160		
2430 G-160		
8224		
S240NB-NR		
8150SL		

2101G-160IP		
2430 G-200 IP		
2465D-200		
2628 G-160IP		
2744		
2951-140		
2952-165		
1520 G		
527 D-160		
7224		
5515FL		

1RM-6, 1RM-7, 1RM-8, 1RM-9, 1RM-10, 1RM-11, 1RM-12, 1RM-13, 1RM-14, 1RM-17, 1RM-19, 1RM-22, 1RM-24, 1RM-27 

111M-6, 111M-7, 111M-8, 111M-9, 111M-10, 111M-11, 111M-12, 111M-13, 111M-14, 111M-15, 111M-16, 111M-17, 111M-18, 111M-19, 111M-20, 111M-21, 111M-22 

Fit&Go 3/3 Foam Inlay Pliers Set - 12 Pcs 



FF1A4001
38 x 445 x 543 mm 1 FF1A4001 

Fit&Go 3/3 Foam Inlay Circlip Pliers Set - 12 Pcs 



FF1A4003
35 x 445 x 543 mm 1 FF1A4003 

Fit&Go 3/3 Foam Inlay Pliers/Wrench Set - 13 Pcs 



FF1A50
45 x 445 x 543 mm 1 FF1A50 

1520 D		
2101G-160IP		
21HDG-200IP		
2223 G-150		

2800-150, 2800-180, 2800-225		
2890-140, 2890-180, 2890-210		
2900-150, 2900-180, 2900-215		
2990-140, 2990-180, 2990-200		

8223 IP, 8224 IP, 8225 IP		
1420		
2430 G-160 IP		
2427 G-160 IP		
8069		
9070		
9031		
2101G-160IP		
21HDG-180IP		



Fit&Go 3/3 Foam Inlay Wrench/Drift Punch Set - 27 Pcs



FF1A5002

50 x 445 x 543 mm 1 FF1A5002

111M-30, 111M-32, 111M-6, 111M-7, 111M-8, 111M-9, 111M-10, 111M-11, 111M-12, 111M-13, 111M-14, 111M-15, 111M-16, 111M-17, 111M-18, 111M-19, 111M-20, 111M-21, 111M-22, 111M-24, 111M-27

3734S/6

Fit&Go 3/3 Foam Inlay 1/4" + 3/8" Socket and Combination Wrench Set - 91 Pcs



FF1A5003

45 x 445 x 543 mm 1 FF1A5003

111M-13, 111M-12, 111M-10, 111M-8, 111M-19, 111M-17, 111M-15

6700SM-5.5, 6700SM-5, 6700SM-14, 6700SM-13, 6700SM-12, 6700SM-11, 6700SM-10, 6700SM-9, 6700SM-8, 6700SM-7, 6700SM-6

6700TORX-E5, 6700TORX-E4, 6700TORX-E10, 6700TORX-E8, 6700TORX-E7, 6700TORX-E6

6709TORX-T27, 6709TORX-T25, 6709TORX-T20, 6709TORX-T15, 6709TORX-T10, 6709TORX-T9, 6709TORX-T8, 6709TORX-T40, 6709TORX-T30

6950

6961, 6962, 6960-6

6966

7400SM-13, 7400SM-12, 7400SM-11, 7400SM-10, 7400SM-9, 7400SM-8, 7400SM-21, 7400SM-19, 7400SM-18, 7400SM-17, 7400SM-16, 7400SM-15, 7400SM-14, 7400SM-22

7400TORX-E18, 7400TORX-E16, 7400TORX-E14, 7400TORX-E12, 7400TORX-E11, 7400TORX-E10, 7400TORX-E8

7409TORX-T30, 7409TORX-T27, 7409TORX-T25, 7409TORX-T50, 7409TORX-T45, 7409TORX-T40

7750

7760, 7761

7762, 7760-3, 7760-5

7764

7765

7766

A6800DM-8, A6800DM-7, A6800DM-6, A6800DM-14, A6800DM-13, A6800DM-12, A6800DM-11, A6800DM-10, A6800DM-9

A7402DM-19, A7402DM-18, A7402DM-17, A7402DM-16, A7402DM-15, A7402DM-14, A7402DM-13, A7402DM-12, A7402DM-11, A7402DM-10

8157-15

6960-4

7771

6972

Fit&Go 3/3 Foam Inlay Wrench/Socket Set - 38 Pcs



FF1A5004

55 x 445 x 543 mm 1 FF1A5004

1RM-19, 1RM-13, 1RM-12, 1RM-11, 1RM-10, 1RM-9, 1RM-8, 1RM-27, 1RM-7, 1RM-24, 1RM-6, 1RM-22, 1RM-17

6700SM-13, 6700SM-12, 6700SM-11, 6700SM-10, 6700SM-9, 6700SM-8, 6700SM-7, 6700SM-6

6950

6960

6966

7800SM-19, 7800SM-17, 7800SM-32, 7800SM-30, 7800SM-13, 7800SM-27, 7800SM-24, 7800SM-22

8155-1/2

SBS86, 6954

8160-5

8166

6960-2

Fit&Go 3/3 Foam Inlay Standard Combination Wrench/Socket Set - 83 Pcs



FF1A5005

50 x 445 x 543 mm 1 FF1A5005

111M-17, 111M-15, 111M-13, 111M-19, 111M-8

6700SM-8, 6700SM-7, 6700SM-6, 6700SM-12, 6700SM-11, 6700SM-10, 6700SM-9, 6700SM-14, 6700SM-13, 6700SM-5, 6700SM-4

6709M-5, 6709M-4, 6709M-8, 6709M-6, 6709M-3

6950SL

6962, 6960-6

6968

7400SM-8, 7400SM-7, 7400SM-6, 7400SM-12, 7400SM-11, 7400SM-10, 7400SM-9, 7400SM-16, 7400SM-15, 7400SM-14, 7400SM-13, 7400SM-18, 7400SM-17

7750SL

7760-W

7761

7768

7800SM-11, 7800SM-10, 7800SM-15, 7800SM-14, 7800SM-13, 7800SM-12, 7800SM-19, 7800SM-18, 7800SM-17, 7800SM-16, 7800SM-22, 7800SM-21, 7800SM-27, 7800SM-24, 7800SM-32, 7800SM-30, 7800SM-8, 7800SM-9

7809M-17, 7809M-14, 7809M-12, 7809M-10, 7809M-5, 7809M-6, 7809M-7, 7809M-8

7809TORX-T40, 7809TORX-T30, 7809TORX-T25, 7809TORX-T20, 7809TORX-T45

8150SL

A6709M-6, A6709M-5, A6709M-4, A6709M-3, A6709M-2.5

K6650-1/4-1P

6960W-2, 6960W-6, 6960-W

8160-5, 8160-10

8166

7760-5

Fit&Go 3/3 Foam Inlay Files and Wrench Set - 27 Pcs



FF1A5006

54 x 445 x 543 mm 1 FF1A5006

1-100-08-2-2		
1-210-08-2-2		
1-230-06-2-2, 1-230-10-2-2		
111M-7, 111M-8, 111M-9, 111M-10, 111M-11, 111M-12, 111M-13, 111M-14, 111M-15, 111M-16, 111M-17, 111M-18, 111M-19, 111M-21, 111M-22		
1320RM-6-7, 1320RM-8-9, 1320RM-10-11, 1320RM-12-13, 1320RM-14-15, 1320RM-16-17, 1320RM-18-19, 1320RM-22-24		

Fit&Go 3/3 Foam Inlay Socket/Striking Toolset - 60 Pcs



FF1A5007

50 x 445 x 543 mm 1 FF1A5007

K6650-1/4-1P, 6954		
3734-2, 3734-3, 3734-4, 3734-5, 3734-6, 3734-8		
481-400		
6700SM-11, 6700SM-12, 6700SM-13, 6700SM-14, 6700SM-10, 6700SM-5, 6700SM-6, 6700SM-7, 6700SM-8, 6700SM-9, 6700SM-4		

6709F-8, 6709F-5.5	
6709M-3, 6709M-4, 6709M-5, 6709M-6	
6709PH-1, 6709PH-2	
6950SL	
6960, 6962, 6960-6	
6966	
7800SM-18, 7800SM-19, 7800SM-10, 7800SM-11, 7800SM-12, 7800SM-13, 7800SM-14, 7800SM-15, 7800SM-16, 7800SM-17, 7800SM-21, 7800SM-22, 7800SM-23, 7800SM-24, 7800SM-25, 7800SM-26, 7800SM-27, 7800SM-28, 7800SM-30, 7800SM-32	
8072 IP	
B145.006.100	
8150SL	
8224 IP	
8154-11	
8160-5, 8160-10	
8166	
6960-2	

Fit&Go 3/3 Foam Inlay Adjustable Wrench/Striking/Measuring Toolset - 24 Pcs



FF1A5008

50 x 445 x 543 mm 1 FF1A5008

1-100-08-2-2		
1-160-08-2-2		
1-170-08-2-2		
1-210-08-2-2		
1-230-08-2-2		
1150D		
1450D-ISO		
1547		
3625N-40		
3734-2, 3734-3, 3734-4, 3734-5, 3734-6, 3734-8		
3735-4-120, 3735-5-150		
3740-125, 3740-150		
38-20		
5515T		
9029, 9031		
MTB-3-16		

Fit&Go 3/3 Foam Inlay Insulated Wrench/Pliers/Screwdriver Set - 17 Pcs



FF1A5009

38 x 445 x 543 mm 1 FF1A5009

2101S-160		1000 V ESCRIBO
2223 S-150		1000 V ESCRIBO
2250V-170		1000 V ESCRIBO
2430 S-200		1000 V ESCRIBO
2628 S-180		1000 V ESCRIBO
8072V		1000 V ESCRIBO
BE-8220S, BE-8040S, BE-8050S, BE-8255S, BE-8065S		
BE-8340		
BE-8601		
BE-8610S, BE-8620S		
BE-8810S, BE-8820S		

Fit&Go 3/3 Foam Inlay Adjustable Wrench/Striking/File/Pliers Set - 22 Pcs



FF1A5010

35 x 445 x 543 mm 1 FF1A5010

1-100-08-1-2		
1-160-08-1-2		
1-170-08-2-2		
1-210-08-1-2		
1-230-08-1-2		
2101G-180IP		
2427 G-200 IP		
2430 G-200 IP		
2628 G-180IP		
3733-2, 3733-4, 3733-6		
3734-2, 3734-3, 3734-4, 3734-5, 3734-6, 3734-8		
3735-4-120		
481-300		
8069 IP		
9031		



Fit&Go 3/3 Foam Inlay Pliers/Striking/File/Screwdriver Set - 27 Pcs



FF1A5011

44 x 445 x 543 mm	1	FF1A5011

1-476-04-3-2	
1178-SCRIBE	
1547	
2101G-160IP	
2427 G-160 IP	
2430 G-160 IP	
3734-2, 3734-3, 3734-4, 3734-5, 3734-6, 3734-8	
3735-5-120	
481-500	
BE-8020L, BE-8040	
BE-8150, BE-8255, BE-8256	
BE-8610, BE-8620	
MTB-3-16	

Fit&Go 3/3 Foam Inlay Striking and Measuring Toolset - 13 Pcs



FF1A5012

48 x 445 x 543 mm	1	FF1A5012

141	
3734-2, 3734-3, 3734-4, 3734-5, 3734-6	
479-08	
481-1000, 481-300	
782-U	
MTS-5-25	
SQZ150003	
319	

Fit&Go 3/3 Foam Inlay Socket/Combination Wrench Set - 41 Pcs



FF1A5013

50 x 445 x 543 mm	1	FF1A5013

111M-6, 111M-7, 111M-8, 111M-9, 111M-12, 111M-13, 111M-17, 111M-10, 111M-11, 111M-19, 111M-20, 111M-22, 111M-24, 111M-27, 111M-32, 111M-30	
6700SM-6, 6700SM-7, 6700SM-8, 6700SM-9, 6700SM-10, 6700SM-11, 6700SM-12, 6700SM-13, 6700SM-14	
6950	
6960	
6966	
7800SM-19, 7800SM-17, 7800SM-13, 7800SM-22, 7800SM-27, 7800SM-24, 7800SM-30, 7800SM-32	
8155-1/2	
SBS86, 6954	
8160-5	
8166	
6960-2	

Fit&Go 3/3 Foam Inlay Wrench/Pliers/Socket Set - 47 Pcs



FF1A5019

52 x 445 x 543 mm	1	FF1A5019

111M-17, 111M-18, 111M-19, 111M-20, 111M-6, 111M-7, 111M-8, 111M-13, 111M-14, 111M-15, 111M-16, 111M-9, 111M-10, 111M-11, 111M-12	
2101G-160IP	
2430 G-160 IP	
2628 G-180IP	

7800DM-12, 7800DM-13, 7800DM-14, 7800DM-15, 7800DM-10, 7800DM-11, 7800DM-20, 7800DM-21, 7800DM-22, 7800DM-23, 7800DM-16, 7800DM-17, 7800DM-18, 7800DM-19, 7800DM-28, 7800DM-30, 7800DM-32, 7800DM-24, 7800DM-25, 7800DM-26, 7800DM-27, 7800DM-8, 7800DM-9

8155-1/2	
8224 IP	
8154-11	
8160-5, 8160-10	
8166	

Fit&Go 3/3 Foam Inlay Screwdriver/Cutting Tool Set - 17 Pcs



FF1A5021

45 x 445 x 543 mm	1	FF1A5021

BE-8020L, BE-8040	
BE-8150, BE-8255, BE-8256	
BE-8340	
BE-8601	
BE-8610, BE-8620	
319	
MTB-5-25	
2444	
268	
5515T	
2509	
2744	
208	

Fit&Go 3/3 Foam Inlay Pliers/Wrench/Socket Set - 26 Pcs



FF1A5022

50 x 445 x 543 mm	1	FF1A5022

6700SM-4.5, 6700SM-5, 6700SM-5.5, 6700SM-6, 6700SM-7, 6700SM-8, 6700SM-9, 6700SM-10, 6700SM-11, 6700SM-12, 6700SM-13, 6700SM-14, 6700SM-4	
6950	
6954	
6956	
6960, 6962, 6960-6	
6966	
8070	
9031	
9072 P	
141	
2101G-160IP	
2430 G-160 IP	
2628 G-180IP	
8224 IP	
6960-2	

Fit&Go 3/3 Foam Inlay Screwdriver/Cutting Tool Set - 16 Pcs



FF1A5023

45 x 445 x 543 mm 1 FF1A5023

208	
2444	
2509	
268	
2744	
319	
5515T	
BE-8020L, BE-8040	
BE-8150, BE-8255, BE-8256	
BE-8340	
BE-8601	
BE-8610, BE-8620	

Fit&Go 3/3 Foam Inlay Wrench and Pliers Set - 28 Pcs



FF1A5024

45 x 445 x 543 mm 1 FF1A5024

111M-12, 111M-13, 111M-6, 111M-7, 111M-8, 111M-9, 111M-10, 111M-11	
1RM-17, 1RM-18, 1RM-19, 1RM-8, 1RM-9, 1RM-10, 1RM-11, 1RM-12, 1RM-13, 1RM-14, 1RM-15, 1RM-16	
2101G-160IP	
2430 G-160 IP	
141	
2628 G-180IP	
9031	
9072 P	
8070	
8224 IP	

Fit&Go 3/3 Foam Inlay Socket/Wrench Set - 32 Pcs



FF1A5028

45 x 445 x 543 mm 1 FF1A5028

111M-6, 111M-7, 111M-8, 111M-9, 111M-10, 111M-11, 111M-14, 111M-15, 111M-16, 111M-17, 111M-18, 111M-19, 111M-20, 111M-12, 111M-13	
1419-MD	
BE-8906, BE-8907, BE-8908, BE-8909, BE-8910, BE-8915, BE-8920, BE-8925, BE-8927, BE-8930, BE-8940, BE-8945	
7805DM-12, 7805DM-13, 7805DM-17, 7805DM-10, 7805DM-19	

Fit&Go 3/3 Foam Inlay Socket and Wrench Set - 75 Pcs



FF1A5032

55 x 445 x 543 mm 1 FF1A5032

6700SM-10, 6700SM-11, 6700SM-8, 6700SM-9, 6700SM-14, 6700SM-12, 6700SM-13, 6700SM-4, 6700SM-6, 6700SM-7, 6700SM-5, 6700SM-4.5, 6700SM-5.5	
6950	
6954	
6956	
6960, 6962, 6960-6	
6966	
7400SM-6, 7400SM-7, 7400SM-10, 7400SM-11, 7400SM-8, 7400SM-9, 7400SM-14, 7400SM-15, 7400SM-12, 7400SM-13, 7400SM-18, 7400SM-19, 7400SM-16, 7400SM-17, 7400SM-22, 7400SM-20, 7400SM-21	
7754, 7760, 7761	
7755-3/8	
7762, 7760-3, 7760-5	
7766	
7800DM-11, 7800DM-14, 7800DM-15, 7800DM-12, 7800DM-13, 7800DM-18, 7800DM-19, 7800DM-16, 7800DM-17, 7800DM-22, 7800DM-23, 7800DM-20, 7800DM-21, 7800DM-26, 7800DM-27, 7800DM-24, 7800DM-30, 7800DM-32, 7800DM-28, 7800DM-8, 7800DM-9, 7800DM-10, 7800DM-25, 7800DM-29	
8155-1/2	
111M-19, 111M-17, 111M-18, 111M-15, 111M-16, 111M-14, 111M-20	
8154-11	
8160-5, 8160-10	
8166	
6960-2	



Fit&Go 3/3 Foam Inlay Hose Clamp Set - 6 Pcs



FF1A5036

38 x 445 x 543 mm 1 FF1A5036

- BE258
- BE250
- BE256P3
- BE254A

Fit&Go 3/3 Foam Inlay File/Pliers/Punch Set - 23 Pcs



FF1A51

40 x 445 x 543 mm 1 FF1A51

- 1-100-08-1-2
- 1-210-08-1-2
- 1-230-08-1-2
- 4-144-08-2-2
- 1-170-08-1-2
- 3735-4-120
- 3733-4, 3733-2, 3733-6
- 3734-2, 3734-3, 3734-4, 3734-5, 3734-6, 3734-8
- 2800-180, 2800-150
- 2890-140, 2890-180
- 2900-150, 2900-180
- 2990-140, 2990-180

Fit&Go 3/3 Foam Inlay 1/4" + 3/8" Long Socket Set - 75 Pcs



FF1A54

35 x 445 x 543 mm 1 FF1A54

- S1612L
- S0810L
- S330L

Fit&Go 3/3 Foam Inlay Wrenches/Hand Hacksaw Set - 28 Pcs



FF1A65

50 x 445 x 543 mm 1 FF1A65

- 111M-19, 111M-17, 111M-18, 111M-24, 111M-21, 111M-22, 111M-7, 111M-8, 111M-6, 111M-11, 111M-12, 111M-9, 111M-10, 111M-15, 111M-16, 111M-13, 111M-14, 111M-20
- 1RM-8, 1RM-9, 1RM-12, 1RM-13, 1RM-10, 1RM-11, 1RM-17, 1RM-14, 1RM-19
- 319

Fit&Go 3/3 Foam Inlay Measuring Tape and Screwdriver Set - 50 Pcs



FF1A66

50 x 445 x 543 mm 1 FF1A66

- 038.055.100, 038.065.125, 038.080.150
- 039.001.100, 039.002.125
- 1178-SCRIBE
- 426TOR9
- 6972H
- 9045-B-250
- BE-8010S, BE-8230S
- BE-8040
- BE-8150, BE-8155
- BE-8800, BE-8811, BE-8821
- BE-8830
- MTB-5-25
- SQZ150003
- 59S/31-1

Fit&Go 3/3 Foam Inlay Screwdriver/Wrench/Pliers Set - 28 Pcs



FF1A67

39 x 445 x 543 mm 1 FF1A67

- 9031
- 2101G-160IP
- 21HDG-180IP
- 2427 G-160 IP
- 2430 G-160 IP
- 8224 IP
- BE-8600, BE-8611, BE-8621
- BE-8630
- BE-8910, BE-8915, BE-8920, BE-8925
- 7865

Fit&Go 3/3 Foam Inlay Files/Striking/Circlip Pliers/Hex Key Set - 30 Pcs



FF1A68

37 x 445 x 543 mm 1 FF1A68

1-100-08-1-2		
1-170-08-1-2		
1-210-08-1-2		
1-230-08-1-2		
2800-180		
2890-180		
2900-180		
2990-180		
3733-4, 3733-2, 3733-6		
3734-8, 3734-5, 3734-6, 3734-3, 3734-4, 3734-2		
3735-4-120		
4-144-08-2-2		
481-400		
BE-9770		

Fit&Go 3/3 Foam Inlay Automotive Bit Set and Clamping Tip Set - 105 Pcs



FF1A70

42 x 445 x 543 mm 1 FF1A70

BE5049		
S560		

Fit&Go 3/3 Foam Inlay Slotted/Phillips/T-Handle Screwdriver Set - 45 Pcs



FF1A71

41 x 445 x 543 mm 1 FF1A71

901T-010-100, 901T-015-150, 901T-020-150, 901T-027-150, 901T-030-200, 901T-040-200, 901T-025-150, 901T-045-200, 901T-050-200		
--	--	--

B190.055.125		
B191.030.075, B191.040.100		
B192.001.100, B192.002.125		
B705.1/4.125		
59/S31B		

Fit&Go 3/3 Foam Inlay Automotive Pliers Set - 18 Pcs



FF1A72

38 x 445 x 543 mm 1 FF1A72

2101GC-160IP		
2430 GC-200 IP		
2630GC-180IP		
2800-180		
2890-180		
2900-180		
2953-200		
2990-180		
3640-200-C		
3734N-10-150, 3734N-2-150, 3734N-3-150, 3734N-4-150, 3734N-5-150, 3734N-6-150, 3734N-8-150		
479-16		
3625W-35		

Fit&Go 3/3 Foam Inlay Striking, Cutting, Pliers & Measuring Tape - 25 pcs



FF1A82

43 x 445 x 543 mm 1 FF1A82

3734S/6		
479-16		
3625W-35		
MTG-3-16		
KB18-01		
KSBG18-10DISPEN		
2101G-180IP		
2678 G-180		
2470 G-200		
720031		
8224 IP		

Fit&Go 2/3 Foam Inlay Slotted Screwdriver Set - 9 Pcs



FF1F1001

40 x 362 x 445 mm 1 FF1F1001

BE-8210, BE-8030, BE-8040, BE-8240, BE-8242, BE-8252, BE-8250L		
BE-8255, BE-8257		

Fit&Go 2/3 Foam Inlay Phillips Screwdriver Set - 11 Pcs



FF1F1002

40 x 362 x 445 mm 1 FF1F1002

BE-8020, BE-8040, BE-8242, BE-8252		
BE-8330		
BE-8256, BE-8258		
BE-8610, BE-8620, BE-8623		
BE-8602		



Fit&Go 2/3 Foam Inlay Slotted/Phillips Screwdriver Set - 11 Pcs



ergo



FF1F1003

Fit & Go

38 x 362 x 445 mm 1 FF1F1003

BE-8030, BE-8242, BE-8252		
BE-8155		
BE-8870		
BE-8600, BE-8610, BE-8620, BE-8623, BE-8624		
808050TS		

Fit&Go 2/3 Foam Inlay TORX® Screwdriver Set - 10 Pcs



ergo



FF1F1004

Fit & Go

38 x 362 x 445 mm 1 FF1F1004

BE-8904, BE-8907, BE-8908		
BE-7910, BE-7915, BE-7920, BE-7925, BE-7927, BE-7930, BE-7940		

Fit&Go 2/3 Foam Inlay TORX®/Bit Screwdriver Set - 12 Pcs



FF1F1005

Fit & Go

43 x 362 x 445 mm 1 FF1F1005

BAHCO

BE-8908, BE-8909, BE-8910, BE-8915, BE-8920, BE-8925, BE-8927, BE-8930		
K6650-1/4-1P		
808050S		
808050		
59S/31-3		

Fit&Go 2/3 Foam Inlay Insulated Slotted/Phillips/Pozidriv Screwdriver Set - 8 Pcs



ergo



FF1F1006



40 x 362 x 445 mm 1 FF1F1006

BE-8230S, BE-8040S, BE-8050S, BE-8255S		
BE-8810S, BE-8820S		
BE-8610S, BE-8620S		

Fit&Go 2/3 Foam Inlay TORX® T-Handle Screwdriver Set - 7 Pcs



FF1F1007



35 x 362 x 445 mm 1 FF1F1007

901T-010-100, 901T-015-150, 901T-020-150, 901T-025-150, 901T-027-150, 901T-030-200, 901T-040-200		
--	--	--

Fit&Go 2/3 Foam Inlay Screwdriver/Hex Key/Bit Set - 49 Pcs



FF1F1008

Fit & Go

38 x 362 x 445 mm 1 FF1F1008

B219.026		
B705.1/4.125		
B146.006.100		
B145.006.100		
BE-9770		
59S/31-1		

Fit&Go 2/3 Foam Inlay Slotted/Phillips/Pozidriv/TORX Screwdriver Set - 14 Pcs



FF1F1009

Fit & Go

38 x 362 x 445 mm 1 FF1F1009

B219.026		
B219.025		
B196.030.100		
B195.002.025		
B195.050.025		

Fit&Go 2/3 Foam Inlay 1/4" Socket and Pear Head Ratchet Set - 44 Pcs



FF1F2001



37 x 362 x 445 mm

1 FF1F2001

A6800DM-4, A6800DM-5, A6800DM-5.5, A6800DM-6, A6800DM-7, A6800DM-8, A6800DM-9, A6800DM-10, A6800DM-11, A6800DM-12, A6800DM-13

6700SM-5, 6700SM-5.5, 6700SM-6, 6700SM-7, 6700SM-8, 6700SM-9, 6700SM-10, 6700SM-11, 6700SM-12, 6700SM-13, 6700SM-14

6709PH-1, 6709PH-2, 6709PH-3

6709PZ-1, 6709PZ-2

6709M-3, 6709M-4, 6709M-5, 6709M-6, 6709M-8

6709F-4.5, 6709F-5.5, 6709F-8

BE-9778

6950SL

7765

6954

6962, 6960-6

6966

6972H

6956

1998M-12

6972

Fit&Go 2/3 Foam Inlay 3/8" Socket and Pear Head Ratchet Set - 36 Pcs



FF1F2101



37 x 362 x 445 mm

1 FF1F2101

7400SM-7, 7400SM-8, 7400SM-9, 7400SM-10, 7400SM-11, 7400SM-12, 7400SM-13, 7400SM-14, 7400SM-15, 7400SM-16, 7400SM-17, 7400SM-18, 7400SM-19, 7400SM-20, 7400SM-21, 7400SM-22

7409M-4, 7409M-6, 7409M-8, 7409M-10

A7402DM-10, A7402DM-11, A7402DM-12, A7402DM-13

A7410DZ-5/16, A7410DZ-7/16, A7410DZ-9/16, A7410DZ-3/8, A7410DZ-5/8

7750SL

7762

7754

7766

7764

8164-1/2

7756

7771

Fit&Go 2/3 Foam Inlay Socket/Bit Set with Magnetic Dish - 53 Pcs



FF1F2002

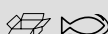

45 x 362 x 445 mm

1 FF1F2002

SL25L

2058/S26

6956

1419-MD

Fit&Go 2/3 Foam Inlay 3/8" Standard/Deep Socket Set - 34 Pcs



FF1F2102



40 x 362 x 445 mm

1 FF1F2102

S330L

Fit&Go 2/3 Foam Inlay 3/8" Socket Set - 38 Pcs

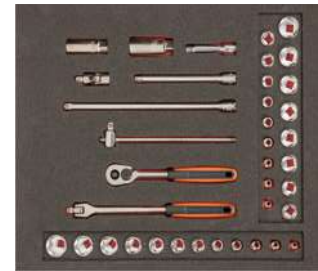

FF1F2103



35 x 362 x 445 mm

1 FF1F2103

S380

Fit&Go 2/3 Foam Inlay 1/2" Socket and Round Head Ratchet Set - 35 Pcs



FF1F2201



50 x 362 x 445 mm

1 FF1F2201

7800SM-10, 7800SM-12, 7800SM-13, 7800SM-17, 7800SM-18, 7800SM-19, 7800SM-20, 7800SM-21, 7800SM-22, 7800SM-24, 7800SM-27, 7800SM-30, 7800SM-32

7800DM-10, 7800DM-11, 7800DM-12, 7800DM-13, 7800DM-14, 7800DM-15, 7800DM-16, 7800DM-17, 7800DM-18, 7800DM-19

7809M-5, 7809M-6, 7809M-7, 7809M-8, 7809M-10, 7809M-12

8150SL

8160-5, 8160-10

8166

8154-11

8171



Fit&Go 2/3 Foam Inlay 1/2" Socket and Pear Head Ratchet Set - 24 Pcs



FF1F2202



50 x 362 x 445 mm

1 FF1F2202

S240



S81SL



Fit&Go 2/3 Foam Inlay Bit Set/Magnetic Dish Set - 50 Pcs



FF1F5004



35 x 362 x 445 mm

1 FF1F5004

BE5049



1419-MD



Fit&Go 2/3 Foam Inlay Turnbuckle Shock Absorber Set - 39 Pcs



FF1F5013



35 x 362 x 445 mm

1 FF1F5013

BS1000



Fit&Go 2/3 Foam Inlay 1/2" Deep Impact Socket Set - 27 Pcs



FF1F2203



50 x 362 x 445 mm

1 FF1F2203

K7801M-10, K7801M-12, K7801M-13, K7801M-14, K7801M-15, K7801M-16, K7801M-17, K7801M-18, K7801M-19, K7801M-21, K7801M-22, K7801M-24



K7806M-10, K7806M-12, K7806M-13, K7806M-14, K7806M-15, K7806M-16, K7806M-17, K7806M-18, K7806M-19, K7806M-21, K7806M-22, K7806M-24, K7806M-27, K7806M-30, K7806M-32



Fit&Go 2/3 Foam Inlay Double Open End Wrench Set - 11 Pcs



FF1F3001



40 x 362 x 445 mm

1 FF1F3001

6M-6-7, 6M-8-9, 6M-10-11, 6M-12-13, 6M-14-15, 6M-16-18, 6M-17-19, 6M-20-22, 6M-21-23, 6M-24-27, 6M-30-32



Fit&Go 2/3 Foam Inlay Combination Wrench Set - 18 Pcs



FF1F3002



41 x 362 x 445 mm

1 FF1F3002

111M-6, 111M-7, 111M-8, 111M-9, 111M-10, 111M-11, 111M-12, 111M-13, 111M-14, 111M-15, 111M-16, 111M-17, 111M-18, 111M-19, 111M-21, 111M-22, 111M-24, 111M-27



Fit&Go 2/3 Foam Inlay Combination Wrench Set - 30 Pcs



FF1F3003



40 x 362 x 445 mm

1 FF1F3003

111M-6, 111M-7, 111M-8, 111M-9, 111M-10, 111M-11, 111M-12, 111M-13, 111M-14, 111M-15, 111M-16, 111M-17, 111M-18, 111M-19, 111M-20, 111M-21, 111M-22



1320SRM-14-19



1RMA-19-1/4-SQ



1RMA-19-1/2-SQ2



1RMA-13-10-BIT



BE-9778



Fit&Go 2/3 Foam Inlay Imperial Combination Wrench Set - 13 Pcs



FF1F3004



42 x 362 x 445 mm

1 FF1F3004

111Z-3/8, 111Z-11/16, 111Z-1, 111Z-1/2, 111Z-13/16, 111Z-5/16, 111Z-5/8, 111Z-15/16, 111Z-7/16, 111Z-3/4, 111Z-1/4, 111Z-9/16, 111Z-7/8



Fit&Go 2/3 Foam Inlay Combination Ratchet Wrench Set - 15 Pcs



FF1F3005



39 x 362 x 445 mm

1 FF1F3005

1RM-8, 1RM-10, 1RM-12, 1RM-13,
1RM-14, 1RM-15, 1RM-16, 1RM-17,
1RM-18, 1RM-19, 1RM-21, 1RM-22

1RMA-13-10-BIT

1RMA-19-1/2-SQ2

Fit&Go 2/3 Foam Inlay Combination Ratchet Wrench Set - 17 Pcs



FF1F3006



35 x 362 x 445 mm

1 FF1F3006

1RM-19, 1RM-21, 1RM-22, 1RM-24,
1RM-27, 1RM-30

Fit&Go 2/3 Foam Inlay Double Open Ring Offset Wrench Set - 10 Pcs



FF1F3007



47 x 362 x 445 mm

1 FF1F3007

2M-6-7, 2M-8-9, 2M-10-11, 2M-12-13,
2M-14-15, 2M-16-18, 2M-17-19, 2M-21-
23, 2M-24-27, 2M-30-32

Fit&Go 2/3 Foam Inlay Double Socket Head Wrench Set - 9 Pcs



FF1F3008



38 x 362 x 445 mm

1 FF1F3008

4040M-6-7, 4040M-8-9, 4040M-10-11,
4040M-12-13, 4040M-14-15, 4040M-
16-17, 4040M-18-19, 4040M-20-22,
4040M-21-23

Fit&Go 2/3 Foam Inlay Flare Nut Wrench Set - 8 Pcs



FF1F3009



35 x 362 x 445 mm

1 FF1F3009

1949M-8-9, 1949M-10-11, 1949M-
12-13, 1949M-14-15, 1949M-17-19,
1949M-19-22, 1949M-24-27, 1949M-
30-32

Fit&Go 2/3 Foam Inlay Combination Wrench Set - 17 Pcs



FF1F3010



35 x 362 x 445 mm

1 FF1F3010

1RM/S5

111M/SH12



Fit&Go 2/3 Foam Inlay Metric Combination Wrench and Ratcheting Ring Wrench Set - 13 Pcs



FF1F3011



35 x 362 x 445 mm

1 FF1F3011

S4RM/3T

111M/SH12



Fit&Go 2/3 Foam Inlay Wrench and Pliers Set - 8 Pcs



FF1F4001



35 x 362 x 445 mm

1 FF1F4001

2430 G-160 IP

2421 G-180 IP

2101G-160IP

2628 G-200

8224 IP

9029

2951-140, 2951-300



Fit&Go 2/3 Foam Inlay Scissors and Pliers Set - 8 Pcs



FF1F4002

35 x 362 x 445 mm	1 FF1F4002

2928-160	
2951-250	
SC127	
2101G-160IP	
2430 G-160 IP	
2339 DIP	
2628 G-180IP	
8224 IP	

Fit&Go 2/3 Foam Inlay Pliers Set - 4 Pcs



FF1F4003

35 x 362 x 445 mm	1 FF1F4003

2101G-160IP	
8224 IP	
2951-180	
2430 G-200 IP	

Fit&Go 2/3 Foam Inlay Circlip Pliers Set - 8 Pcs



FF1F4004

35 x 362 x 445 mm	1 FF1F4004

2800-140, 2800-180	
2890-140, 2890-180	
2900-140, 2900-180	
2990-140, 2990-180	

Fit&Go 2/3 Foam Inlay Insulated Cutter/Pliers Set - 5 Pcs



FF1F4005

38 x 362 x 445 mm	1 FF1F4005

2101S-160		1000 V ESD0000
2430 S-200		1000 V ESD0000
2427 S-200		1000 V ESD0000
8224 IP		17E
2628 S-180		1000 V ESD0000

Fit&Go 2/3 Foam Inlay File/Measuring Tape/Pliers Set - 10 Pcs



FF1F5001

40 x 362 x 445 mm	1 FF1F5001

1-100-08-1-2	
1-160-08-1-2	
1-170-08-1-2	
1-210-08-1-2	
1-230-08-1-2	
2430 G-200 IP	
2628G-200IP	
7224	
2101G-160IP	
MTB-3-16	

Fit&Go 2/3 Foam Inlay Tin Snip/Rivet Gun/Measuring Tape Set - 5 Pcs



FF1F5002

38 x 362 x 445 mm	1 FF1F5002

2681	
MA401	
MA411	
1178-SCRIBE	
MTG-5-19	

Fit&Go 2/3 Foam Inlay Pliers/Adjustable Wrench Set - 5 Pcs



FF1F5003

35 x 362 x 445 mm	1 FF1F5003

8224	
2101G-160	
2430 G-160	
8071	
2951-250	

Fit&Go 2/3 Foam Inlay Cutting Tool Set - 8 Pcs



FF1F5005

40 x 362 x 445 mm 1 FF1F5005

317	
3906-300-24-5P	
268	
2446	

Fit&Go 2/3 Foam Inlay End Terminal Pliers/Multimeter Set - 4 Pcs



FF1F5006

50 x 362 x 445 mm 1 FF1F5006

CR W 01	
CR B 05	
3418 A	
BMMTRMS1	

Fit&Go 2/3 Foam Inlay Puller Set - 5 Pcs



FF1F5007

45 x 362 x 445 mm 1 FF1F5007

4543-1, 4543-2, 4543-3	
4545-2	
4541-A	

Fit&Go 2/3 Foam Inlay Knife/Awl/Hook Set - 11 Pcs



FF1F5008

37 x 362 x 445 mm 1 FF1F5008

2633/S4	
2633L/S4	
2489	
2485	
KE18-01	

Fit&Go 2/3 Foam Inlay Puller/Joint Fork Set - 5 Pcs



FF1F5009

60 x 362 x 445 mm 1 FF1F5009

BS618, BS623	
4545-2	
4545-N11	
4532-0	

Fit&Go 2/3 Foam Inlay Mix Brush/Ring Wrench Set - 9 Pcs



FF1F5010

45 x 362 x 445 mm 1 FF1F5010

BBR6135	
BBR6131	
BBR110	
1949M-8-9, 1949M-10-11	
7809M-6, 7809M-8, 7809M-10	
783	

Fit&Go 2/3 Foam Inlay 1/2" Impact Wrench Set - 7 Pcs



FF1F5011

100 x 362 x 445 mm 1 FF1F5011

BP815	
BP821	
BP822	
BP823	

Fit&Go 2/3 Foam Inlay 1/2" Mini Impact Wrench Set - 9 Pcs



FF1F5012

55 x 362 x 445 mm 1 FF1F5012

BWSS12P317, BWSS12P319, BWS-S12P321	
BPC814	
BWTB12P120	
GL008-10	
783	
8157-15	



Fit&Go 1/3 Foam Inlay 4 Slotted/3 Phillips Screwdriver Set - 7 Pcs



FF1E1001



38 x 181 x 445 mm

1 FF1E1001

BE-8030, BE-8040, BE-8242, BE-8252



BE-8610, BE-8620, BE-8623



Fit&Go 1/3 Foam Inlay 5 Slotted/2 Phillips Screwdriver Set - 7 Pcs



FF1E1002



39 x 181 x 445 mm

1 FF1E1002

BE-8242, BE-8040, BE-8030



BE-8257, BE-8255



BE-8611, BE-8621



Fit&Go 1/3 Foam Inlay Slotted/Pozidriv Screwdriver Set - 6 Pcs



FF1E1003



38 x 181 x 445 mm

1 FF1E1003

BE-8240



BE-8150, BE-8255, BE-8256



BE-8810, BE-8820



Fit&Go 1/3 Foam Inlay Slotted/Phillips/Pozidriv Screwdriver Set - 8 Pcs



FF1E1004



40 x 181 x 445 mm

1 FF1E1004

BE-8340, BE-8350



BE-8600, BE-8610



BE-8811, BE-8800, BE-8820L, BE-8821



Fit&Go 1/3 Foam Inlay Slotted/Phillips/Pozidriv/Hex Screwdriver Set - 7 Pcs



FF1E1005



40 x 181 x 445 mm

1 FF1E1005

BE-8210, BE-8010



BE-8811, BE-8821, BE-8800



BE-8600



BE-8830



Fit&Go 1/3 Foam Inlay Slotted/Phillips/Pozidriv Screwdriver Set - 6 Pcs



FF1E1006



40 x 181 x 445 mm

1 FF1E1006

BE-8210



BE-8610, BE-8620



BE-8630



BE-8811, BE-8820



Fit&Go 1/3 Foam Inlay TORX® Screwdriver Set T10-T40 - 6 Pcs



FF1E1007



40 x 181 x 445 mm

1 FF1E1007

BE-8910, BE-8915, BE-8920, BE-8925, BE-8930, BE-8940



Fit&Go 1/3 Foam Inlay TORX® Tamper-Resistant Screwdriver Set TR10-TR40 - 6 Pcs



FF1E1008



38 x 181 x 445 mm

1 FF1E1008

BE-7910, BE-7930, BE-7925, BE-7920, BE-7915, BE-7940



Fit&Go 1/3 Foam Inlay TORX® Screwdriver Set T8-T30 - 6 Pcs



FF1E1009



38 x 181 x 445 mm

1 FF1E1009

BE-8908, BE-8910, BE-8915, BE-8920,
BE-8925, BE-8930



Fit&Go 1/3 Foam Inlay Slotted/Phillips
Insulated Screwdriver Set 39 mm x 181
mm x 445 mm - 6 Pcs



ergo



FF1E1010



39 x 181 x 445 mm

1 FF1E1010

BE-8010S, BE-8230S, BE-8050S,
BE-8255S



BE-8610S, BE-8620S



Fit&Go 1/3 Foam Inlay Slotted/Phillips
Insulated Screwdriver Set 45 mm x 181
mm x 445 mm - 6 Pcs



ergo



FF1E1011



45 x 181 x 445 mm

1 FF1E1011

BE-8040S, BE-8050S, BE-8255S,
BE-8065S



BE-8610S, BE-8620S



Fit&Go 1/3 Foam Inlay 1/4" Socket and
Pear Head Ratchet Set - 37 Pcs



FF1E2001



38 x 181 x 445 mm

1 FF1E2001

6700SM-4, 6700SM-5, 6700SM-5.5,
6700SM-6, 6700SM-7, 6700SM-8,
6700SM-9, 6700SM-10, 6700SM-11,
6700SM-12, 6700SM-13, 6700SM-14



6700TORX-E4, 6700TORX-E5,
6700TORX-E6, 6700TORX-E7,
6700TORX-E8, 6700TORX-E10



6709M-3, 6709M-4, 6709M-5, 6709M-6,
6709M-8



6709TORX-T8, 6709TORX-T9,
6709TORX-T10, 6709TORX-T15,
6709TORX-T20, 6709TORX-T25,
6709TORX-T30, 6709TORX-T27,
6709TORX-T40



6950SL



6954

6956



6960



6966



6960-2



Fit&Go 1/3 Foam Inlay 1/4" Socket and
Pear Head Ratchet Set - 45 Pcs



FF1E2002



38 x 181 x 445 mm

1 FF1E2002

6700SM-4, 6700SM-4.5, 6700SM-5,
6700SM-5.5, 6700SM-6, 6700SM-7,
6700SM-8, 6700SM-9, 6700SM-10,
6700SM-11, 6700SM-12, 6700SM-13,
6700SM-14



6709PZ-1, 6709PZ-3, 6709PZ-2



6709PH-1, 6709PH-2, 6709PH-3

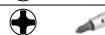

6709TORX-T10, 6709TORX-T15,
6709TORX-T20, 6709TORX-T25,
6709TORX-T30, 6709TORX-T40

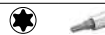

6709F-4.5, 6709F-5.5, 6709F-8



6709M-3, 6709M-4, 6709M-5, 6709M-6,
6709M-8

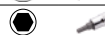

1998M-3, 1998M-2.5, 1998M-2, 1998M-
1.5



6950SL



6962-W, 6954

6966



6956



6960, 6961



7765



6960-2, 6972



6960-4



Fit&Go 1/3 Foam Inlay 1/4" Socket and
Pear Head Ratchet Set - 19 Pcs



FF1E2003



38 x 181 x 445 mm

1 FF1E2003

6700SM-5, 6700SM-5.5, 6700SM-6,
6700SM-7, 6700SM-8, 6700SM-9,
6700SM-10, 6700SM-11, 6700SM-12,
6700SM-13, 6700SM-14

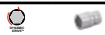

BE-9778



6950SL



6956



6962, 6960-6



6966



7765



6954



1998M-12



6972

Fit&Go 1/3 Foam Inlay 1/4" Socket and
Pear Head Ratchet Set - 48 Pcs



FF1E2004



44 x 181 x 445 mm

1 FF1E2004

A6700DM-8, A6700DM-9, A6700DM-10,
A6700DM-11, A6700DM-12,
A6700DM-13, A6700DM-14,
A6700DM-5, A6700DM-5.5,
A6700DM-6, A6700DM-7

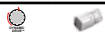

808050S



6950SL



6966



6972H



6962, 6960-6



7765



59S/31-1

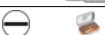

6972



Fit&Go 1/3 Foam Inlay 1/4" Socket and Pear Head Ratchet Set - 17 Pcs



FF1E2005

35 x 181 x 445 mm 1 FF1E2005

- 6700SM-5.5, 6700SM-6, 6700SM-7, 6700SM-8, 6700SM-9, 6700SM-10, 6700SM-11, 6700SM-12, 6700SM-13, 6700SM-14
- 6950RN
- 6962, 6960, 6960-6
- 6966
- 6954
- 6956
- 6972H
- 6960-2

Fit&Go 1/3 Foam Inlay 1/4" Socket and Round Head Ratchet Set - 35 Pcs



FF1E2006

39 x 181 x 445 mm 1 FF1E2006

- 6700SZ-5/16, 6700SZ-5/32, 6700SZ-11/32, 6700SZ-7/16, 6700SZ-9/32, 6700SZ-3/16, 6700SZ-3/8, 6700SZ-7/32, 6700SZ-1/4, 6700SZ-1/2, 6700SZ-9/16
- 6709PZ-1, 6709PZ-2, 6709PZ-3
- 6709PH-1, 6709PH-2, 6709PH-3
- 6709TORX-T8, 6709TORX-T10, 6709TORX-T15, 6709TORX-T20, 6709TORX-T25, 6709TORX-T30
- 6709F-4.5, 6709F-6.5, 6709F-8
- 6950RN
- 6954, 6963
- 6972H
- 6960, 6962, 6960-6
- 6966
- 6956
- 7765
- 6960-2, 6972

Fit&Go 1/3 Foam Inlay 1/4" Socket and Round Head Ratchet Set - 24 Pcs



FF1E2007

35 x 181 x 445 mm 1 FF1E2007

- 6700SZ-9/32, 6700SZ-3/16, 6700SZ-3/8, 6700SZ-1/4, 6700SZ-7/16, 6700SZ-7/32, 6700SZ-1/2, 6700SZ-11/32
- 1995Z-5/64, 1995Z-5/32, 1995Z-3/8, 1995Z-3/32, 1995Z-7/32, 1995Z-1/8, 1995Z-5/16, 1995Z-3/16, 1995Z-1/4
- 6950RN
- 6954
- 6972H
- 6960, 6962, 6960-6
- 6956
- 6966
- 6960-2

Fit&Go 1/3 Foam Inlay 1/4" Socket and Round Head Ratchet Set - 26 Pcs



FF1E2008

35 x 181 x 445 mm 1 FF1E2008

- 6700SM-5.5, 6700SM-6, 6700SM-7, 6700SM-8, 6700SM-9, 6700SM-10, 6700SM-11, 6700SM-12, 6700SM-13, 6700SM-14
- 1995M-2, 1995M-3, 1995M-4, 1995M-5, 1995M-6, 1995M-7, 1995M-8, 1995M-9, 1995M-10
- 6950RN
- 6960, 6962, 6960-6
- 6966
- 6954
- 6956
- 6972H
- 6960-2

Fit&Go 1/3 Foam Inlay 3/8" Socket and Pear Head Ratchet Set - 24 Pcs



FF1E2101

40 x 181 x 445 mm 1 FF1E2101

- 7400SM-6, 7400SM-7, 7400SM-8, 7400SM-9, 7400SM-10, 7400SM-11, 7400SM-12, 7400SM-13, 7400SM-14, 7400SM-15, 7400SM-16, 7400SM-17, 7400SM-18, 7400SM-19, 7400SM-20, 7400SM-22
- 7750SL
- 7760, 7761, 7754
- 7762, 7760-3, 7760-5
- 7764
- 7766
- 8164-1/2
- 7771

Fit&Go 1/3 Foam Inlay 3/8" Socket and Pear Head Ratchet Set - 25 Pcs



FF1E2102

38 x 181 x 445 mm 1 FF1E2102

- 7400SM-6, 7400SM-7, 7400SM-8, 7400SM-9, 7400SM-10, 7400SM-11, 7400SM-12, 7400SM-13, 7400SM-14, 7400SM-15, 7400SM-16, 7400SM-17, 7400SM-18, 7400SM-19
- 7409M-4, 7409M-5, 7409M-6, 7409M-8, 7409M-10
- 7750SL
- 7760, 7754
- 7762, 7760-3
- 7768
- 8164-1/2

Fit&Go 1/3 Foam Inlay 3/8" Socket and Pear Head Ratchet Set - 28 Pcs



FF1E2103



38 x 181 x 445 mm

1 FF1E2103

7400SM-7, 7400SM-8, 7400SM-9, 7400SM-10, 7400SM-11, 7400SM-12, 7400SM-13, 7400SM-14, 7400SM-15, 7400SM-16, 7400SM-17, 7400SM-18, 7400SM-19, 7400SM-20, 7400SM-21, 7400SM-22		
7400TORX-E8, 7400TORX-E10, 7400TORX-E12, 7400TORX-E14, 7400TORX-E16, 7400TORX-E18		
7750SL		
7760		
7762, 7760-3		
7768		
7766		
SBS705		

Fit&Go 1/3 Foam Inlay 3/8" Socket and Round Head Ratchet Set - 20 Pcs



FF1E2104



38 x 181 x 445 mm

1 FF1E2104

7400SM-6, 7400SM-8, 7400SM-9, 7400SM-10, 7400SM-11, 7400SM-12, 7400SM-13, 7400SM-14, 7400SM-15, 7400SM-16, 7400SM-17, 7400SM-18, 7400SM-19, 7400SM-20, 7400SM-22		
7750RN		
7761		
7762, 7760-5		
7766		
7768		

Fit&Go 1/3 Foam Inlay 3/8" Socket and Bit Driver Set - 28 Pcs



FF1E2105



35 x 181 x 445 mm

1 FF1E2105

7400TORX-E8, 7400TORX-E10, 7400TORX-E11, 7400TORX-E12, 7400TORX-E14, 7400TORX-E16, 7400TORX-E18		
7409TORX-T25, 7409TORX-T30, 7409TORX-T40, 7409TORX-T45, 7409TORX-T50		
7409TORX-T25-L, 7409TORX-T30-L, 7409TORX-T40-L, 7409TORX-T45-L, 7409TORX-T50-L		
7409M-4, 7409M-5, 7409M-6, 7409M-8, 7409M-10		
7409F-6.5, 7409F-8, 7409F-10		
7409PH-1, 7409PH-2, 7409PH-3		

Fit&Go 1/3 Foam Inlay 1/2" Socket and Round Head Ratchet Set - 21 Pcs



FF1E2201



44 x 181 x 445 mm

1 FF1E2201

7800SM-10, 7800SM-11, 7800SM-12, 7800SM-13, 7800SM-14, 7800SM-15, 7800SM-17, 7800SM-18, 7800SM-19, 7800SM-20, 7800SM-21, 7800SM-22, 7800SM-24, 7800SM-27		
7805SM-16, 7805SM-21		
8150SL		
8160-5, 8160-10		
8166		
8171		

Fit&Go 1/3 Foam Inlay 1/2" Socket and Pear Head Ratchet Set - 21 Pcs



FF1E2202



45 x 181 x 445 mm

1 FF1E2202

7800SM-8, 7800SM-9, 7800SM-10, 7800SM-11, 7800SM-12, 7800SM-13, 7800SM-14, 7800SM-15, 7800SM-16, 7800SM-17, 7800SM-18, 7800SM-19, 7800SM-20, 7800SM-21, 7800SM-23, 7800SM-24, 7800SM-27		
8150-1/2		
8160-5, 8160-10		
8166		

Fit&Go 1/3 Foam Inlay 1/2" Socket and Round Head Ratchet Set - 22 Pcs



FF1E2203



50 x 181 x 445 mm

1 FF1E2203

7800SM-8, 7800SM-9, 7800SM-10, 7800SM-11, 7800SM-12, 7800SM-13, 7800SM-14, 7800SM-15, 7800SM-16, 7800SM-17, 7800SM-18, 7800SM-19, 7800SM-22, 7800SM-21, 7800SM-24, 7800SM-27, 7800SM-30, 7800SM-32		
8150RN-1/2		
8160-5, 8160-10		
8166		



Fit&Go 1/3 Foam Inlay 1/2" Socket and Round Head Ratchet Set - 15 Pcs



FF1E2204



45 x 181 x 445 mm



1 FF1E2204

7800DZ-1/2, 7800DZ-3/4, 7800DZ-19/32, 7800DZ-7/8, 7800DZ-7/16, 7800DZ-11/16, 7800DZ-9/16, 7800DZ-13/16, 7800DZ-3/8, 7800DZ-5/8, 7800DZ-15/16

8150RN-1/2

8160-5, 8160-10

8166

Fit&Go 1/3 Foam Inlay 1/2" Socket Set - 28 Pcs



FF1E2205



50 x 181 x 445 mm



1 FF1E2205

7800DM-10, 7800DM-11, 7800DM-12, 7800DM-13, 7800DM-14, 7800DM-15, 7800DM-16, 7800DM-17, 7800DM-18, 7800DM-19, 7800DM-20, 7800DM-21, 7800DM-22, 7800DM-23, 7800DM-24, 7800DM-25, 7800DM-26, 7800DM-27, 7800DM-28, 7800DM-30, 7800DM-32

7809M-6, 7809M-7, 7809M-8, 7809M-9, 7809M-10, 7809M-12, 7809M-14

Fit&Go 1/3 Foam Inlay 1/2" Socket Set - 27 Pcs



FF1E2206



50 x 181 x 445 mm



1 FF1E2206

7800SM-10, 7800SM-11, 7800SM-12, 7800SM-13, 7800SM-14, 7800SM-15, 7800SM-16, 7800SM-17, 7800SM-18, 7800SM-19, 7800SM-20, 7800SM-21, 7800SM-22, 7800SM-23, 7800SM-24, 7800SM-25, 7800SM-26, 7800SM-27, 7800SM-28, 7800SM-30, 7800SM-32

7809XZN-8, 7809XZN-10

7809PZ-2, 7809PZ-3

7809F-8, 7809F-10

Fit&Go 1/3 Foam Inlay 1/2" Socket Set/Bit Set/Key Set - 25 Pcs



FF1E2207



40 x 181 x 445 mm



1 FF1E2207

7809TORX-T20, 7809TORX-T25, 7809TORX-T27, 7809TORX-T30, 7809TORX-T40, 7809TORX-T55, 7809TORX-T45, 7809TORX-T50, 7809TORX-T60

7800TORX-E8, 7800TORX-E10, 7800TORX-E12, 7800TORX-E14, 7800TORX-E16, 7800TORX-E18, 7800TORX-E20, 7800TORX-E24

BE-9675

Fit&Go 1/3 Foam Inlay 1/2" Bit Driver Set - 12 Pcs



FF1E2208



35 x 181 x 445 mm



1 FF1E2208

7809M-6, 7809M-7, 7809M-8, 7809M-9, 7809M-10, 7809M-12, 7809M-14, 7809M-17

7809M-5-180, 7809M-6-140, 7809M-8-120, 7809M-10-140

Fit&Go 1/3 Foam Inlay 1/2" Bit Driver Set - 20 Pcs



FF1E2209



35 x 181 x 445 mm



1 FF1E2209

7809M-5, 7809M-6, 7809M-7, 7809M-8, 7809M-10, 7809M-12, 7809M-14, 7809M-17

7809TORX-T25, 7809TORX-T27, 7809TORX-T30, 7809TORX-T40, 7809TORX-T45, 7809TORX-T50, 7809TORX-T55, 7809TORX-T60

7809XZN-6, 7809XZN-8, 7809XZN-10, 7809XZN-12

Fit&Go 1/3 Foam Inlay 1/2" Bit Driver Set/Impact Socket Set - 14 Pcs









FF1E2210



38 x 181 x 445 mm



1 FF1E2210

7809M-5, 7809M-6, 7809M-7, 7809M-8, 7809M-10, 7809M-12, 7809M-14, 7809M-17, 7809M-19		
BE-7606, BE-7607		
BWSS12P317, BWSS12P319, BWS-S12P321		







Fit&Go 1/3 Foam Inlay 1/2" Socket Set - 21 Pcs



FF1E2211

50 x 181 x 445 mm 1 FF1E2211

7993S0050, 7993S0060, 7993S0080, 7993S0100, 7993S0120, 7993S0140, 7993S0170, 7993S0190		
7994S0300, 7994S0400, 7994S0450, 7994S0500, 7994S0550, 7994S0600		
K7801TORX-E10, K7801TORX-E12, K7801TORX-E14, K7801TORX-E16, K7801TORX-E18, K7801TORX-E20, K7801TORX-E24		



Fit&Go 1/3 Foam Inlay 1/2" Socket Set - 12 Pcs



FF1E2212



40 x 181 x 445 mm 1 FF1E2212

K7801M-10, K7801M-12, K7801M-13, K7801M-14, K7801M-15, K7801M-16, K7801M-17, K7801M-18, K7801M-19, K7801M-21, K7801M-22, K7801M-24		
--	---	---

Fit&Go 1/3 Foam Inlay 1/2" Power Deep Socket Set - 15 Pcs



FF1E2213



45 x 181 x 445 mm 1 FF1E2213

K7806M-10, K7806M-12, K7806M-13, K7806M-14, K7806M-15, K7806M-16, K7806M-17, K7806M-18, K7806M-19, K7806M-21, K7806M-22, K7806M-24, K7806M-27, K7806M-30, K7806M-32		
---	---	--





Fit&Go 1/3 Foam Inlay 1/2" Socket Set - 13 Pcs



FF1E2501



35 x 181 x 445 mm 1 FF1E2501

A7402DM-10, A7402DM-11, A7402DM-12, A7402DM-13, A7402DM-14		
7805SM-12, 7805SM-13, 7805SM-14, 7805SM-15, 7805SM-16, 7805SM-17, 7805SM-18, 7805SM-19		





Fit&Go 1/3 Foam Inlay 1/2" to 3/4" Power Socket Set - 7 Pcs



FF1E2502

45 x 181 x 445 mm 1 FF1E2502

K560F-4, K560F-5	
K8167S	
K8160D-1, K8160D-2	
K7764D	
K8964D	



Fit&Go 1/3 Foam Inlay Socket/Extractor Set - 35 Pcs



FF1E5005

36 x 181 x 445 mm 1 FF1E5005

BWTSP16		
1418S		







Fit&Go 1/3 Foam Inlay Socket/Torsion Bar Set - 6 Pcs



FF1E5006

42 x 181 x 445 mm 1 FF1E5006

D/S14		
BWSS12P3		
BWTB12P120, BWTB12P110		



Fit&Go 1/3 Foam Inlay Mix Oil Plug Socket Set - 17 Pcs



FF1E5009

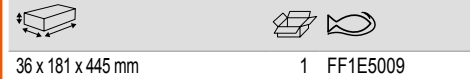

36 x 181 x 445 mm 1 FF1E5009

BE6217

Fit&Go 1/3 Foam Inlay Double Open End Wrench Set - 8 Pcs



FF1E3001

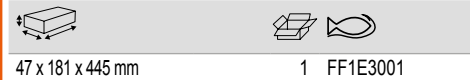

47 x 181 x 445 mm 1 FF1E3001

6M-6-7, 6M-8-9, 6M-10-11, 6M-12-13, 6M-14-15, 6M-16-17, 6M-18-19, 6M-21-23, 6M-22-24

Fit&Go 1/3 Foam Inlay Double Open End Wrench Set - 3 Pcs



FF1E3002



35 x 181 x 445 mm 1 FF1E3002

6M-25-28, 6M-27-29, 6M-30-32

Fit&Go 1/3 Foam Inlay Double Open End Wrench Set - 9 Pcs



FF1E3003



41 x 181 x 445 mm 1 FF1E3003

6Z-1/2-9/16, 6Z-15/16-1, 6Z-5/16-11/32, 6Z-5/8-3/4, 6Z-3/8-7/16, 6Z-25/32-13/16, 6Z-19/32-11/16, 6Z-1/4-5/16, 6Z-3/4-7/8

Fit&Go 1/3 Foam Inlay Combination Ratcheting Wrench Set - 10 Pcs



FF1E3004

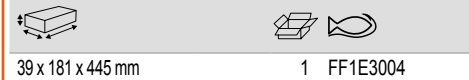

39 x 181 x 445 mm 1 FF1E3004

1RM-10, 1RM-9, 1RM-8, 1RM-14, 1RM-13, 1RM-12, 1RM-11, 1RM-17, 1RM-16, 1RM-15

Fit&Go 1/3 Foam Inlay Combination Ratcheting Wrench Set - 40 Pcs



FF1E3005



42 x 181 x 445 mm 1 FF1E3005

59S/31-1

6966

41RM-8, 41RM-10, 41RM-12, 41RM-13, 41RM-14, 41RM-17, 41RM-19

8166

Fit&Go 1/3 Foam Inlay Ratcheting Wrench Set - 8 Pcs



FF1E3006

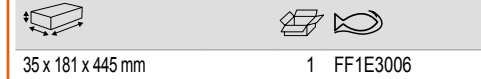

35 x 181 x 445 mm 1 FF1E3006

1320RM-6-7, 1320RM-8-9, 1320RM-10-11, 1320RM-12-13, 1320RM-14-15, 1320RM-16-17, 1320RM-18-19, 1320RM-22-24

Fit&Go 1/3 Foam Inlay Double Open Ring Offset Wrench Set - 7 Pcs



FF1E3007



35 x 181 x 445 mm 1 FF1E3007

2M-6-7, 2M-8-9, 2M-10-11, 2M-12-13, 2M-14-15, 2M-16-17, 2M-18-19

Fit&Go 1/3 Foam Inlay Double Open End Pipe Wrench Set - 9 Pcs



FF1E3008



50 x 181 x 445 mm 1 FF1E3008

27M-8-9, 27M-10-11, 27M-12-13, 27M-14-15, 27M-16-17, 27M-18-19, 27M-20-22, 27M-21-23, 27M-24-27

Fit&Go 1/3 Foam Inlay Pliers Set - 4 Pcs



ergo®



FF1E4001



35 x 181 x 445 mm

1 FF1E4001

2628 G-180IP	
8231 IP	
2430 G-200 IP	
2101G-160IP	

Fit&Go 1/3 Foam Inlay Circlip Pliers Set - 4 Pcs



FF1E4002



35 x 181 x 445 mm

1 FF1E4002

2900-180		
2890-180		
2990-180		
2800-180		

Fit&Go 1/3 Foam Inlay Wrench and Pliers Set - 3 Pcs



ergo®



FF1E5007



38 x 181 x 445 mm

1 FF1E5007

1410	
9033	
8225	

Fit&Go 1/3 Foam Inlay Measuring Tool Set - 7 Pcs



FF1E5001



45 x 181 x 445 mm

1 FF1E5001

MTB-5-25	
8045LVDE	
WR2-MM	
1544	
1178-SCRIBE	
5515T	
1150D	

Fit&Go 1/3 Foam Inlay Hammer/Punch/Impact Driver Set - 35 Pcs



FF1E5004



36 x 181 x 445 mm

1 FF1E5004

481-400	
3734S/6	
7865	

Fit&Go 1/3 Foam Inlay Hammer/Flat Chisel/Cotter Pin Punch Set - 11 Pcs



FF1E5002



35 x 181 x 445 mm

1 FF1E5002

3740-150, 3740-175, 3740-200	
3734-2, 3734-3, 3734-4, 3734-5, 3734-6, 3734-8	
481-100	
1157	

Fit&Go 1/3 Foam Inlay Hammer/Flat Chisel/Drift Punch Set - 11 Pcs



FF1E5003



35 x 181 x 445 mm

1 FF1E5003

481-300	
3735-5-120	
3739-300	
3740-100, 3740-125, 3740-150, 3740-200	
3733-2, 3733-3, 3733-4, 3733-5	

Fit&Go 1/3 Foam Inlay Spark Plug Socket and Pliers Set - 4 Pcs



FF1E5008



37 x 181 x 445 mm

1 FF1E5008

7805ZZ-16, 7805ZZ-21	
BE1P	
BE6110	

Fit&Go 1/3 Foam Inlay ERGO™ Blade Screwdriver Set - 6 pcs Retail Pack



ergo®



FF1E1012EH



55 x 185 x 480 mm

1 FF1E1012EH

BE-8030	
BE-8150	
BE-8621, BE-8611	
BE-8811, BE-8821	



Fit&Go 1/3 Foam Inlay Torx® Screwdriver Set T8-T30 - 6 pcs Retail Pack



ergo



FF1E1009EH



55 x 185 x 480 mm

1 FF1E1009EH

BE-8908, BE-8910, BE-8915, BE-8920, BE-8925, BE-8930

Fit&Go 1/3 Foam Inlay ERGO™ Through Blade Screwdriver Set - 6 pcs Retail Pack



ergo



FF1E1013EH



55 x 185 x 480 mm

1 FF1E1013EH

BE-8135TB, BE-8145TB, BE-8150TB, BE-8155TB

BE-8810TB, BE-8820TB

Fit&Go 1/3 Foam Inlay 1/4" Socket Set & Bit Set - 46 pcs Retail Pack



FF1E2009EH



55 x 185 x 480 mm

1 FF1E2009EH

59/S31B-IP

6700SM-4, 6700SM-4.5, 6700SM-5, 6700SM-5.5, 6700SM-6, 6700SM-7, 6700SM-8, 6700SM-9, 6700SM-10, 6700SM-11, 6700SM-12, 6700SM-13

6962-W

6972H

6950SL

Fit&Go 1/3 Foam Inlay 1/4" Deep Socket Set - 11 pcs Retail Pack



FF1E2010EH



55 x 185 x 480 mm

1 FF1E2010EH

S0810L

1419-MD

Fit&Go 1/3 Foam Inlay 3/8" Socket Set - 18 pcs Retail Pack



FF1E2106EH



55 x 185 x 480 mm

1 FF1E2106EH

7400SM-10, 7400SM-11, 7400SM-12, 7400SM-13, 7400SM-14, 7400SM-15, 7400SM-16, 7400SM-17, 7400SM-18, 7400SM-19, 7400SM-20, 7400SM-22

7760, 7761

7766

SBS750

7402GPR-16, 7402GPR-21

7760-3, 7760-5

Fit&Go 1/3 Foam Inlay 1/2" Socket Set - 21 pcs Retail Pack



FF1E2214EH



55 x 185 x 480 mm

1 FF1E2214EH

7800SM-10, 7800SM-11, 7800SM-12, 7800SM-13, 7800SM-14, 7800SM-15, 7800SM-16, 7800SM-17, 7800SM-18, 7800SM-19, 7800SM-20, 7800SM-21, 7800SM-22, 7800SM-23, 7800SM-24, 7800SM-27, 7800SM-30, 7800SM-32

8150SL

8174A

8166

Fit&Go 1/3 Foam Inlay 3/8" Deep Socket Set - 14 pcs Retail Pack



FF1E2107EH



55 x 185 x 480 mm

1 FF1E2107EH

S1214L

Fit&Go 1/3 Foam Inlay 1/2" Deep Socket Set - 12 pcs Retail Pack



FF1E2215EH



55 x 185 x 480 mm

1 FF1E2215EH

S1612L

Fit&Go 1/3 Foam Inlay Bit Set - 49 pcs Retail Pack



FF1E2503EH



55 x 185 x 480 mm

1 FF1E2503EH

BE5049

Fit&Go 1/3 Foam Inlay Combination Spanners Set - 11 pcs Retail Pack



FF1E3009EH



55 x 185 x 480 mm

1 FF1E3009EH

111M-8, 111M-10, 111M-11, 111M-12, 111M-13, 111M-14, 111M-15, 111M-16, 111M-17, 111M-18, 111M-19

Fit&Go 1/3 Foam Inlay 1RM Ratcheting Spanners Set - 5 pcs Retail Pack



FF1E3010EH



55 x 185 x 480 mm

1 FF1E3010EH

1RM-8, 1RM-10, 1RM-13, 1RM-17, 1RM-19

Fit&Go 1/3 Foam Inlay Magnetic Dish & Adjustable Spanners Set - 4 pcs Retail Pack



FF1E3011EH

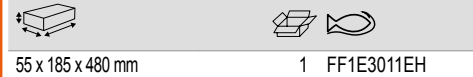

8070 IP, 8071 IP, 8072 IP
1419-MD

Fit&Go 1/3 Foam Inlay Pliers Set - 3 pcs Retail Pack



FF1E4003EH



8224 IP
2101G-160IP
2430 G-160 IP

Fit&Go 1/3 Foam Inlay Rivet Gun & Metal Shears Set - 4 pcs Retail Pack



FF1E4004EH

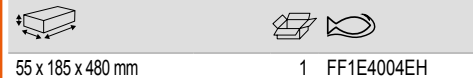

2681
MA401
MA411
1178-SCRIBE

Fit&Go 1/3 Foam Inlay Hammer, Pin Punches & Impact Driver Set - 23 pcs Retail Pack



FF1E5010EH



481-400
3734-2, 3734-3, 3734-4, 3734-5, 3734-6, 3734-8
3735-5-120
7865

Fit&Go 1/3 Foam Inlay Circlip Pliers Set - 4 pcs Retail Pack



FF1E4005EH



2800-150, 2800-180
2900-150, 2900-180

Fit&Go 1/3 Foam Inlay Awls, Hooks & Knives - 11 pcs Retail Pack



FF1E5011EH



2633/S4
2633/L/S4
2489
2485
KE18-01

Fit&Go 1/3 Foam Inlay L-Keys, Bit Set & Magnetic Dish - 36 pcs Retail Pack



FF1E5013EH



BE-9770
2058/S26
1419-MD

Fit&Go 1/3 Foam Inlay 1/4" Socket Set - 25 pcs Retail Pack



FF1E2011EH



SL25

Fit&Go 1/3 Foam Inlay 1/2" Ratchet & Accessories Set - 24 pcs Retail Pack



FF1E2216EH



SBS81
S240NB-NR

Fit&Go 1/3 Foam Inlay 1/4" & 3/8" Socket Set - 33 pcs Retail Pack



FF1E2504EH



S330



Fit&Go 1/3 Foam Inlay 1/4" & 3/8" Socket Set - 34 pcs Retail Pack



FF1E2505EH

55 x 185 x 480 mm 1 FF1E2505EH

S330AF

Fit&Go 1/3 Foam Inlay Adjustable Spanner, Slip Joint Pliers & Metal Cutting Set - 8 pcs Retail Pack



FF1E5014EH

55 x 185 x 480 mm 1 FF1E5014EH

- 9031P
- 8224
- 208
- 3906-300-24-5P

1/3 Empty Foam with Cavities and Hanger



FF1E5016EH

35 x 181 x 445 mm 1 FF1E5016EH

Fit&Go 1/3 Foam Inlay ERGO™ Files Set - 4 pcs Retail Pack



FF1E5015EH

55 x 185 x 480 mm 1 FF1E5015EH

- 1-100-08-2-2
- 1-210-08-2-2
- 4-138-08-1-2
- 4-272-05-3-2

Solid Claw and Ring Mountings for 1477K Storage HUB Tool Trolleys



1477K-AC11

30 x 39 x 68 mm 1 1477K-AC11

Removable Long Guiding Poles for 1477K Storage HUB Tool Trolleys



1477K-AC28

455 x 25 x 25 mm 1 1477K-AC28

Removable Short Guiding Poles for 1477K Storage HUB Tool Trolleys



1477K-AC29

130 x 25 x 25 mm 1 1477K-AC29

Leather Key Rings for Trolley Keys



KEYRING

10 x 30 x 70 mm 0.20 kg 50 KEYRING

Sheet of Tags for 1477K/1472K/1475K Storage HUB Tool Trolleys



1477K-AC23

1 x 210 x 300 mm 1 1477K-AC23

Drawer Liner Set - 7 Pcs



1470KAC1

0.5 x 445 x 543 mm 1 1470KAC01

RIGID CASES

Heavy Duty Rigid Case General Purpose Toolkit - 162 Pcs



4750RCWD4FF1



453 x 340 x 575 mm

1 4750RCWD4FF1

4750RCWD4

6700SM-10, 6700SM-9, 6700SM-12, 6700SM-11, 6700SM-6, 6700SM-8, 6700SM-7, 6700SM-13	
A6800DM-13, A6800DM-12, A6800DM-9, A6800DM-8, A6800DM-11, A6800DM-10, A6800DM-5.5, A6800DM-7, A6800DM-6	
6709M-3, 6709M-8, 6709M-6, 6709M-5, 6709M-4	
6709PH-1, 6709PH-3, 6709PH-2	
6709TORX-T30, 6709TORX-T27, 6709TORX-T40, 6709TORX-T15, 6709TORX-T10, 6709TORX-T25, 6709TORX-T20, 6709TORX-T9, 6709TORX-T8	
6950SL	
6954, 7764, 2058-BR, BFLA01	
6956	
6958	
6960, 6962, 6962L	
6966	
6972H	
7800SM-25, 7800SM-24, 7800SM-27, 7800SM-26, 7800SM-21, 7800SM-23, 7800SM-22, 7800SM-17, 7800SM-16, 7800SM-19, 7800SM-18, 7800SM-13, 7800SM-12, 7800SM-15, 7800SM-14, 7800SM-9, 7800SM-8, 7800SM-11, 7800SM-10, 7800SM-28, 7800SM-32, 7800SM-30	

7809TORX-T45, 7809TORX-T25, 7809TORX-T50, 7809TORX-T30, 7809TORX-T27, 7809TORX-T40

8150RN-1/2

111M-30, 111M-32, 111M-27, 111M-29, 111M-24, 111M-19, 111M-18, 111M-21, 111M-15, 111M-14, 111M-17, 111M-16, 111M-11, 111M-10, 111M-13, 111M-12, 111M-7, 111M-6, 111M-9, 111M-8

9070C

BE-9770

1544

MTB-3-16

2101G-160IP

2427 G-200 IP

2430 G-200 IP

2628 G-160IP

8224 IP

1150-1/2H/P

5515T-52

2820EF2

481-300

3625W-35

3734-3, 3734-5, 3734-8

3735-4-120

1177-SCRIBE

8160-3, 8160-5, 8160-10

8166

8157-15

8154-11

Heavy Duty Rigid Case Insulated Tool Kit - 79 pcs



4750RCHDW02RF1V



290 x 480 x 630 mm

1 4750RCHDW02RF1V

4750RCHDW02RED

8150-1/2V

BMMTRMS1

28MV-10, 28MV-15, 28MV-16, 28MV-21, 28MV-22, 28MV-12, 28MV-13

2101S-160, 2101S-180

2101S-200

2223 S-150

2820VDE

BE-8040S, BE-8050S, BE-8010S, BE-8065S

BE-8703S, BE-8704S, BE-8725S, BE-8705S, BE-8706S, BE-8708S

BE-8910S, BE-8915S, BE-8920S, BE-8925S, BE-8930S

SC127V

1999MV-5, 1999MV-6, 1999MV-7, 1999MV-8, 1999MV-9, 1999MV-10, 1999MV-12

2430V-160, 2430V-200

2678V-180, 2678V-160, 2678V-200

3416 A

806-1-1

BE-8600S, BE-8610S, BE-8620S, BE-8630S, BE-8640S

527V-160

2427V-200

2MV-10, 2MV-11, 2MV-12, 2MV-13, 2MV-14, 2MV-15, 2MV-16, 2MV-17, 2MV-18, 2MV-19

WR1-MM

7800DMV-8, 7800DMV-10, 7800DMV-11, 7800DMV-12, 7800DMV-13, 7800DMV-14, 7800DMV-15, 7800DMV-16, 7800DMV-17, 7800DMV-18, 7800DMV-19, 7800DMV-20, 7800DMV-21, 7800DMV-22

2820VPC

8162-1/2V

7224S



Heavy Duty Rigid Case MRO Toolkit - 195 Pcs



4750RCHDW02FF1

275 x 460 x 600 mm 1 4750RCHDW02FF1

4750RCHDW02		
6700SM-12, 6700SM-13, 6700SM-10, 6700SM-11, 6700SM-8, 6700SM-9, 6700SM-6, 6700SM-7, 6700SM-5.5		
A6800DM-13, A6800DM-11, A6800DM-12, A6800DM-9, A6800DM-10, A6800DM-7, A6800DM-8, A6800DM-5.5, A6800DM-6		
6709M-3, 6709M-4, 6709M-8, 6709M-5, 6709M-6		
6709PH-1, 6709PH-2, 6709PH-3		
6709TORX-T8, 6709TORX-T30, 6709TORX-T40, 6709TORX-T25, 6709TORX-T27, 6709TORX-T15, 6709TORX-T20, 6709TORX-T9, 6709TORX-T10		
6950SL		
6954, 7764, 2058-BR, BFLA01		
6956		
6958		
6960, 6962, 6962L		
6966		
6972H		
7800SM-13, 7800SM-14, 7800SM-11, 7800SM-12, 7800SM-9, 7800SM-10, 7800SM-8, 7800SM-32, 7800SM-30, 7800SM-27, 7800SM-28, 7800SM-25, 7800SM-26, 7800SM-23, 7800SM-24, 7800SM-21, 7800SM-22, 7800SM-19, 7800SM-17, 7800SM-18, 7800SM-15, 7800SM-16		
7805SM-22, 7805SM-23, 7805SM-21, 7805SM-18, 7805SM-19, 7805SM-16, 7805SM-17, 7805SM-14, 7805SM-15, 7805SM-12, 7805SM-13, 7805SM-10, 7805SM-32, 7805SM-30, 7805SM-26, 7805SM-27, 7805SM-24, 7805SM-29, 7805SM-28, 7805SM-25, 7805SM-20		
7809TORX-T30, 7809TORX-T40, 7809TORX-T25, 7809TORX-T27, 7809TORX-T50, 7809TORX-T45		
8150RN-1/2		
111M-23, 111M-24, 111M-21, 111M-22, 111M-19, 111M-17, 111M-18, 111M-15, 111M-16, 111M-13, 111M-14, 111M-11, 111M-12, 111M-9, 111M-10, 111M-7, 111M-8, 111M-6, 111M-32, 111M-29, 111M-30, 111M-27, 111M-28, 111M-26, 111M-25		
1RM-18, 1RM-19, 1RM-16, 1RM-17, 1RM-14, 1RM-15, 1RM-12, 1RM-13, 1RM-10, 1RM-11, 1RM-8, 1RM-9, 1RM-6, 1RM-7		
9070C		
BE-9770		

BE-8571		
2509		
1544		
2101G-160IP		
2427 G-200 IP		
2430 G-200 IP		
2628 G-160IP		
8224 IP		
1150-1/2H/P		
5515T-52		
2820EF2		
481-300		
3625W-35		
3734-3, 3734-5, 3734-8		
3735-4-120		
1177-SCRIBE		
2535F1		
MTB-3-16		
8160-3, 8160-5, 8160-10		
8166		
8154-11		
8157-15		

Heavy Duty Rigid Case Windpower Toolkit - 167 Pcs



4750RCHDW02FF2

480 x 290 x 630 mm 1 4750RCHDW02FF2

4750RCHDW02		
6700SM-12, 6700SM-13, 6700SM-10, 6700SM-11, 6700SM-8, 6700SM-9, 6700SM-6, 6700SM-7, 6700SM-5.5		
6954, 2058-BR, BFLA01		
6956		
6958		
6960, 6961, 6962, 6962L		
6966		
6972H		
6950SL		
7800SM-13, 7800SM-14, 7800SM-11, 7800SM-12, 7800SM-10, 7800SM-32, 7800SM-30, 7800SM-27, 7800SM-24, 7800SM-21, 7800SM-19, 7800SM-17, 7800SM-18, 7800SM-15, 7800SM-16		

7809M-7, 7809M-6, 7809M-17, 7809M-19, 7809M-5, 7809M-14, 7809M-12, 7809M-10, 7809M-8		
7809TORX-T60, 7809TORX-T40, 7809TORX-T55, 7809TORX-T50, 7809TORX-T45		
59S/31-1		
8150SL		
111M-24, 111M-21, 111M-19, 111M-17, 111M-18, 111M-15, 111M-16, 111M-13, 111M-14, 111M-11, 111M-12, 111M-9, 111M-10, 111M-7, 111M-8, 111M-6, 111M-32, 111M-29, 111M-30, 111M-27		
BE-9770		
1177-SCRIBE		
6M-6-7, 6M-8-9, 6M-10-11, 6M-12-13, 6M-14-15, 6M-16-17, 6M-18-19, 6M-20-22, 6M-24-27, 6M-30-32		
MTB-3-16-E		
9070, 9072		
2535L		
BE-8020L, BE-8030		
BE-8155		
BE-8260		
BE-8610, BE-8620		
BE-8630		
BE-8810, BE-8820		
BE-8830		
1544		
2047-0-8-4		
TAH2047PR-1-2		
2509		
808050P		
808050S		
BE-8220S, BE-8040S, BE-8050S		
BE-8610S, BE-8620S		
2535F2		
1150-1/2H/P		
2101G-160IP		
2427 G-200 IP		
2430 G-200 IP		
2628 G-160IP		
2820EF2		
5515T-52		
8224 IP		
3625W-35		
3734-3, 3734-5, 3734-8		
3735-4-120		
481-300		
3680		
3875-RL1		
3875-WL1		
4750-3PB-2		
3750		
8157-15		
8154-11		
8160-5, 8160-10		
8171		
8166		

Heavy Duty Rigid Case Windmills
Standard Application Toolkit - 114 Pcs



4750RCHDW02FF4



480 x 290 x 630 mm

1 4750RCHDW02FF4

TAH9070, TAH9072		
TAH3625W-35		
TAH481-300		
TAHBE-9777B		
TAH2820EF2		
TAH1150-1/2H/P		
TAH1177-SCRIBE		
TAH1544		
TAH2509		
TAH2535F2		
MTS-5-25		
TAHPINRELEASER		
TAH2427G-200		
TAH2430G-200		
TAH2628G-160		
TAH8224		
TAH2484-30		
TAH3734BM-3, TAH3734BM-8, TAH-3734BM-5		
TAH3755BM-4		
TAHSCB140G		
TAHBE-8030, TAHBE-8020L		
TAHBE-8040S, TAHBE-8050S, TAHBE-8220S		
TAHBE-8155		
TAHBE-8260		
TAHBE-8620S, TAHBE-8610S		
TAHBE-8620, TAHBE-8610		
TAHBE-8630		
TAHBE-8810, TAHBE-8820		
TAHBE-8830		
TAH08-5.5, TAH08-9, TAH08-7, TAH08-8, TAH08-13, TAH08-6, TAH08-11, TAH08-10, TAH08-12		
TAH6961, TAH6962, TAH6960, TAH6962L		
TAH6956-1		
TAH6950		
TAH6966		
TAH6958B-1		

TAH16B-27, TAH16B-30, TAH16B-24, TAH16B-22, TAH16B-32, TAH16B-19, TAH16B-21, TAH16B-17, TAH16B-18, TAH16B-11, TAH16B-15, TAH16B-16, TAH16B-13, TAH16B-10, TAH16B-14, TAH16B-12		
TAH16-H8, TAH16-H6, TAH16-H7, TAH16-H5, TAH16-H17, TAH16-H19, TAH16-H12, TAH16-H14, TAH16-H10		
TAH16-T40, TAH16-T45, TAH16-T50, TAH16-T55, TAH16-T60		
TAH8166		
TAH8150-1/2		
TAH8160, TAH8162		
TAH8158B-1		
TAH111M-32, TAH111M-27, TAH111M-24, TAH111M-21, TAH111M-22, TAH111M-19, TAH111M-9, TAH111M-7, TAH111M-8, TAH111M-18, TAH111M-6, TAH111M-16, TAH111M-17, TAH111M-14, TAH111M-15, TAH111M-12, TAH111M-13, TAH111M-10, TAH111M-11, TAH111M-30		
TAH2101G-160		
TAH2047PR-1-2		
TAH2047-0.8-4		
4750RCHDW02		

Heavy Duty Rigid Case Windmills Heavy
Duty Application Toolkit - 36 Pcs



4750RCHDW02FF15



480 x 290 x 630 mm

1 4750RCHDW02FF15

TAH1-100-06-2-4		
TAH1-210-06-2-2		
TAH1-230-06-2-2		
TAH3625PU-50		
TAH489-1100		
TAHBE64520		
TAHPINRELEASER		
TAHSCB140G		
TAH24B-50, TAH24B-46, TAH24B-41, TAH24B-38, TAH24B-36, TAH24B-32, TAH24B-30, TAH24B-27		
TAH8950N/A		
TAH8961		
TAH8953		
TAH7452-2		
TAH7435-100		
TAH111M-50, TAH111M-46, TAH111M-41, TAH111M-36, TAH111M-34		

TAH7444SG-M-46, TAH7444SG-M-41, TAH7444SG-M-36, TAH7444SG-M-55, TAH7444SG-M-50		
4750RCHDW02		
TAH73R-300		

Heavy Duty Rigid Case Aviation Toolkit -
240 Pcs



4750RCHDW01FF1



250 x 345 x 545 mm

1 4750RCHDW01FF1

4750RCHDW01		
FF2B01		
FF2B02		
FF2B03		
FF2B04		
FF2B05		
FF2B06		

Heavy Duty Rigid Case Aviation Toolkit -
159 Pcs



4750RCHDW01FF2



250 x 345 x 545 mm

1 4750RCHDW01FF2

4750RCHDW01		
FF2B07		
FF2B08		
FF2B09		
FF2B10		
FF2B11		



Heavy Duty Rigid Case General Purpose Toolkit - 194 Pcs



4750RCHDW01FF3



250 x 345 x 545 mm



1 4750RCHDW01FF3

4750RCHDW01	
FF2B12	
FF2B13	
FF2B14	
FF2B15	
FF2B16	

Heavy Duty Rigid Case Offshore Oil and Gas Crane Maintenance Application Toolkit - 29 Pcs



4750RCHDW01FF4



250 x 345 x 545 mm



1 4750RCHDW01FF4

TAH8075	
TAH479-32	
TAHBE-9777B	
TAHBE-9787	
TAH2820EF2	
TAHBFRL11	
TAH466-250	

TAHPINRELEASER	
TAH380-10	
TAH2101G-160	
TAH2628G-180	
TAH2855	
TAH8224	
TAHSCB140G	
TAHBE-8258	
TAHBE-8241, TAHBE-8252	
TAHBE-8620L, TAHBE-8620	
4750RCHDW01	
4750-HDLB-TAH	
3875-LY9	
3875-LY5	
3875-RL2	
3875-MHP4	
3875-MHP6	
3875-HB60	
3875-LY60	
3875-LY70	

Heavy Duty Rigid Case Offshore Oil and Gas Training Application Toolkit - 41 Pcs



4750RCHDW01FF9



250 x 345 x 545 mm



1 4750RCHDW01FF9

TAH8073	
TAH84-PODGER	
TAH3640-250-C	
TAH1-143-12-1-2	
TAH479-32	
TAH325	
TAHBE-9777B	
TAH2820EF2	
TAHBFRL11	
TAHPINRELEASER	
TAH380-14	
TAH2101G-140	
TAH2628G-180	
TAH2855	

TAH2958-250	
TAH2484-30	
TAH3734BM-8	
TAHSCB140G	
TAHBE-8257	
TAHBE-8602	
TAH16B-19	
TAH16B-11/16	
TAH16-H8	
TAH8150-1/2	
TAH8158B-1	
TAH1949M-14-17	
4750RCHDW01	
4750-HDLB-TAH	
3875-LY9	
3875-LY5	
3875-RL2	
3875-MHP4	
3875-MHP6	
MTS-5-25	
4750-MTHO-TAH	
3875-HB60	
TAH2487	
TAH466-250	
3875-LY60	
3875-LY70	
TAH73R-300	

Aviation Toolkit - 159 Pcs/Rigid Case



4750RCHD01FF1



215 x 410 x 475 mm



1 4750RCHD01FF1

4750RCHD01	
FF2A07	
FF2A08	
FF2A10	
FF2A09	

Aluminium Tool Box General Purpose Toolkit, 145pcs



4750ALC01FF1



160 x 320 x 450 mm

1 4750ALC01FF1

111M-14, 111M-15, 111M-16, 111M-17, 111M-18, 111M-19, 111M-8, 111M-9, 111M-10, 111M-11, 111M-12, 111M-13	
BE-9678	
8072 C IP	
224 D	
2171G-160	
2339-220IP	
2678 G-180	
2470 G-160	
SCB140	
B191.030.075, B191.040.125	
B190.055.125, B190.065.150	
B192.001.100, B192.002.125	
806-1-1	
482F-30	
MTB-5-25	
208	
KB18-01	
808050TS	
59S/0.6-4.5-3P, 59S/1.0-5.5-3P, 59S/1.2-6.5-3P	
59S/PH1-3P, 59S/PH2-3P, 59S/PH3-3P, 59S/PH0-3P	
59S/PH2G-3P	
59S/PZ2-3P, 59S/PZ3-3P, 59S/PZ0-3P, 59S/PZ1-3P	
66IM/T20C-2P, 66IM/T15C-2P, 66IM/T10C-2P, 66IM/T40C-2P, 66IM/T30C-2P, 66IM/T27C-2P, 66IM/T25C-2P	
59S/H1.5-3P, 59S/H3-3P, 59S/H2.5-3P, 59S/H4-3P, 59S/H5-3P, 59S/H2-3P, 59S/H6-3P, 59S/H8-3P	
KM6750-11, KM6750-6, KM6750-7, KM6750-8	
KM6750-10, KM6750-13, K6650-1/4-1P, SB6963	
KM653-1P	
KSBG18-10DISPEN	
700-1.5-50, 700-1.2-50, 700-1-50, 700-1.8-50	
701-00-50, 701-0-50	
3906-250-24-5P, 3906-250-32-5P	
3735N-4-120	
3734N-2-150, 3734N-4-150, 3734N-6-150	
SBS60-9, SBS60-10, SBS60-11, SBS60-12, SBS60-13, SBS60-4, SBS60-4.5, SBS60-5, SBS60-5.5, SBS60-6, SBS60-7, SBS60-8	
SBS61	
SBS64	

6960-3	
8160-10, 8160-5	
8158-10	
7800SM-20, 7800SM-21, 7800SM-22, 7800SM-23, 7800SM-24, 7800SM-27, 7800SM-12, 7800SM-13, 7800SM-14, 7800SM-15, 7800SM-16, 7800SM-17, 7800SM-18, 7800SM-19, 7800SM-10, 7800SM-11, 7800SM-30, 7800SM-32	
SBS81	
8166	
7772H	

Wheeled Rigid Case General Purpose Toolkit - 32 Pcs



984010320



255 x 390 x 465 mm

1 984010320

4750RCW01	
2101D-160IP	
224 D	
2630D-180	
2430 D-160 IP	
6M/8C	
8071 C IP	
483-20	
541D-180	
2951-180	
B191.030.075, B191.040.100	
B190.100.200, B190.065.150	
B192.001.100, B192.002.125	
SC127	
2820EF2	
BE-9777	
MTB-3-16	

Rigid Case General Purpose Toolkit - 32 Pcs



983100320



210 x 415 x 460 mm

1 983100320

4750RC02	
2101D-160IP	
224 D	
2430 D-160 IP	
8071 C IP	
483-20	
541D-180	
2951-180	
6M/8C	
B191.030.075, B191.040.100	
B190.100.200, B190.065.125	
B192.001.100, B192.002.125	
SC127	
2820EF2	
BE-9777	
MTB-3-16	

4750RC02	
2101D-160IP	
224 D	
2430 D-160 IP	
8071 C IP	
483-20	
541D-180	
2951-180	
B191.030.075, B191.040.100	
B190.100.200, B190.065.150	
B192.001.100, B192.002.125	
SC127	
2820EF2	
BE-9777	
MTB-3-16	
2630DC-180IP	
6M/8C	

Plastic Case General Purpose Toolkit - 32 Pcs



983000320



162 x 380 x 435 mm

1 983000320

4750RC01	
2101D-160IP	
224 D	
2630D-180	
2430 D-160 IP	
8071 C IP	
483-20	
541D-180	
2951-180	
6M/8C	
B191.030.075, B191.040.100	
B190.100.200, B190.065.125	
B192.001.100, B192.002.125	
SC127	
2820EF2	
BE-9777	
MTB-3-16	



150 L Wheeled Rigid Tool Cases with Telescopic Handle and 4 Drawers



4750RCWD4



453 x 340 x 575 mm

1 4750RCWD4

29 L Heavy Duty Rigid Cases



4750RCHD01



215 x 415 x 465 mm

1 4750RCHD01*

Indestructible tool case with injected copolymer polypropylene structural resin

23-35 L Rigid Tool Cases



4750RC01



165 x 399 x 450 mm

1 4750RC01

53 L Wheeled Heavy Duty Rigid Cases



4750RCHDW02



290 x 480 x 630 mm
290 x 480 x 630 mm

1 4750RCHDW02

1 4750RCHDW02RED

60x37mm wheels on ball bearings

29 L Heavy Duty Rigid Cases with Tool Pallets



4750RCHD011



215 x 415 x 465 mm

1 4750RCHD011

Swivelling Wheel Kit - 4 Pcs



4750RCWD-AC1



100 x 50 x 200 mm

1 4750RCWD-AC1

31 L Wheeled Heavy Duty Rigid Cases



4750RCHDW01



240 x 350 x 545 mm
240 x 350 x 545 mm

1 4750RCHDW01

1 4750RCHDW01RED

60x20 wheels on ball bearing for easy transport even when very loaded

18.5 L Heavy Duty Rigid Cases



4750RCHD00



205 x 345 x 400 mm

1 4750RCHD00*

Pivoting Under Lid Tool Pallets with Pouch System



4750RCWD-AC2



30 x 277 x 507 mm

1 4750RCWD-AC2

Pivoting Under Lid Tool Pallets with Fixed Elastics



4750RCWD-AC3



5 x 277 x 507 mm



1 4750RCWD-AC3

Fixed Under Lid Tool Pallets with Adjustable Elastics



4750RCWD-AC4



4 x 286 x 490 mm



1 4750RCWD-AC4

Removable Padded Lid Panels for 4750RCHD01



4750RCHD01AC1



35 x 305 x 425 mm



1 4750RCHD01AC1

Removable Padded Bags for 4750RCHD01 Heavy Duty Rigid Case



4750RCHD01AC2



135 x 360 x 450 mm



1 4750RCHD01AC2

Removable Lid Panels for 4750RCHDW01 Heavy Duty Case



4750RCHDW01AC1



50 x 204 x 500 mm



1 4750RCHDW01AC1

Internal Bags for 4750RCHDW01 Heavy Duty Rigid Case



4750RCHDW01AC2



120 x 280 x 525 mm



1 4750RCHDW01AC2

TSA Locks for 4750RCHD Cases



4750RCHD-AC1



20 x 40 x 70 mm



1 4750RCHD-AC1

Foam Inlay Socket Set for 4750RCHD01 Heavy Duty Rigid Case - 64 Pcs



FF2A07



45 x 330 x 430 mm



1 FF2A07

A6700DZ-1/2, A6700DZ-1/4, A6700DZ-11/32, A6700DZ-3/16, A6700DZ-3/8, A6700DZ-5/16, A6700DZ-7/16, A6700DZ-7/32, A6700DZ-9/16, A6700DZ-9/32		
A6710DZ-3/8, A6710DZ-5/16, A6710DZ-7/16, A6710DZ-1/4		
A6800DZ-1/2, A6800DZ-1/4, A6800DZ-11/32, A6800DZ-3/16, A6800DZ-3/8, A6800DZ-5/16, A6800DZ-7/16, A6800DZ-7/32, A6800DZ-9/16, A6800DZ-9/32		
A7400DZ-1/2, A7400DZ-11/16, A7400DZ-13/16, A7400DZ-19/32, A7400DZ-3/4, A7400DZ-3/8, A7400DZ-5/8, A7400DZ-7/16, A7400DZ-7/8, A7400DZ-9/16		
A7402DZ-1/2, A7402DZ-11/16, A7402DZ-13/16, A7402DZ-19/32, A7402DZ-3/4, A7402DZ-3/8, A7402DZ-5/8, A7402DZ-7/16, A7402DZ-7/8, A7402DZ-9/16		
2058-BR, 6954, 7764		
6950SL		
6956		
6960, 6962, 6962L		
6966		
6972H		
7407H, 7408H		
7750SL		
7752		
7760, 7761		
7762		
7765		
7766		
8164-1/2		

* Until stocks last



Foam Inlay Wrench and File Set for 4750RCHD01 Heavy Duty Rigid Case - 24 Pcs



FF2A08

45 x 335 x 435 mm	1	FF2A08

1-100-04-2-2		
1-230-04-2-2		
111Z-1, 111Z-1/2, 111Z-1/4, 111Z-11/16, 111Z-3/4, 111Z-3/8, 111Z-5/16, 111Z-5/8, 111Z-7/16, 111Z-9/16, 111Z-7/8		
1177-SCRIBE		
1320RZ-1/2-9/16, 1320RZ-1/4-5/16, 1320RZ-3/8-7/16, 1320RZ-5/16-11/32		
1931Z-1/4, 1931Z-3/16, 1931Z-7/32		
1950MZ-3/8		
208		
9031 C		

Foam Inlay Screwdriver and Wrench Set for 4750RCHD01 Heavy Duty Rigid Case - 56 Pcs



FF2A09

45 x 335 x 440 mm	1	FF2A09

BE-8040, BE-8210		
BE-8260		
BE-8600, BE-8610, BE-8620		
BE-9780		
MTB-3-16-E		
2047-1-5-5		
2047PR-1-2		
59/S28-4		
2509		
2535F2		
5515T-52		
808050		
1179-FLX-2, BFLA01		
BE-8150		

Foam Inlay Toolset for Heavy Duty Rigid Cases - 15 Pcs



FF2A10

49 x 330 x 435 mm	1	FF2A10

2101GC-160IP		
2427 GC-200IP		
2628 GC-160IP		
2632		
2650		
2855		
2979 D-180		
3625N-32		
3734-2, 3734-3, 3734-4, 3734-5		
3735-4-120		
481-300		
8224CIP		

Foam Inlay Socket Set for 4750RCHD01 Heavy Duty Rigid Case - 61 Pcs



FF2B01

40 x 270 x 505 mm	1	FF2B01

A6700DZ-1/2, A6700DZ-1/4, A6700DZ-11/32, A6700DZ-3/16, A6700DZ-3/8, A6700DZ-5/16, A6700DZ-7/16, A6700DZ-7/32, A6700DZ-9/16, A6700DZ-9/32		
A6800DZ-1/2, A6800DZ-1/4, A6800DZ-11/32, A6800DZ-3/16, A6800DZ-3/8, A6800DZ-5/16, A6800DZ-7/16, A6800DZ-7/32, A6800DZ-9/16, A6800DZ-9/32		
A7400DZ-1/2, A7400DZ-1/4, A7400DZ-11/16, A7400DZ-17/32, A7400DZ-19/32, A7400DZ-3/4, A7400DZ-3/8, A7400DZ-5/16, A7400DZ-5/8, A7400DZ-7/16, A7400DZ-9/16		

A7402DZ-1/2, A7402DZ-1/4, A7402DZ-11/16, A7402DZ-19/32, A7402DZ-3/4, A7402DZ-3/8, A7402DZ-5/16, A7402DZ-5/8, A7402DZ-7/16, A7402DZ-9/16

6950SL		
6954, 7764		
6956		
6958		
6960, 6961, 6962L		
6966		
6972H		
7407H		
7750SL		
7752		
7760, 7761		
7762		
7765		
7766		
8164-1/2		
U-S6106KA		

Foam Inlay Wrench and Socket Set for 4750RCHD01 Heavy Duty Rigid Case - 69 Pcs



FF2B02

39 x 270 x 505 mm	1	FF2B02

A6700DM-5.5, A6700DM-6, A6700DM-11, A6700DM-12, A6700DM-13, A6700DM-14, A6700DM-7, A6700DM-8, A6700DM-9, A6700DM-10		
A6800DM-6, A6800DM-7, A6800DM-8, A6800DM-9, A6800DM-4, A6800DM-5, A6800DM-5.5, A6800DM-14, A6800DM-10, A6800DM-11, A6800DM-12, A6800DM-13		
A7400DM-10, A7400DM-14, A7400DM-15, A7400DM-16, A7400DM-11, A7400DM-12, A7400DM-17, A7400DM-18, A7400DM-19, A7400DM-13		
A7402DM-19, A7402DM-15, A7402DM-16, A7402DM-17, A7402DM-18, A7402DM-11, A7402DM-12, A7402DM-13, A7402DM-14, A7402DM-10		
BE-9770		
111M-24, 111M-6, 111M-7, 111M-12, 111M-13, 111M-14, 111M-15, 111M-8, 111M-9, 111M-10, 111M-11, 111M-22, 111M-16, 111M-17, 111M-18, 111M-19		
4020L-M-5, 4020L-M-5.5		

Foam Inlay Wrench and Socket Set for 4750RCHDW01 Heavy Duty Rigid Case - 44 Pcs



FF2B03

35 x 270 x 505 mm	1 FF2B03

A6710DM-7		
A6710DZ-1/2, A6710DZ-1/4, A6710DZ-11/32, A6710DZ-3/16, A6710DZ-3/8, A6710DZ-5/16, A6710DZ-7/16, A6710DZ-7/32, A6710DZ-9/16, A6710DZ-9/32		
BE-9780		
111Z-1, 111Z-1/2, 111Z-1/4, 111Z-11/16, 111Z-3/4, 111Z-3/8, 111Z-5/16, 111Z-5/8, 111Z-7/16, 111Z-7/8, 111Z-9/16, 111Z-13/16		
1320RZ-1/2-9/16, 1320RZ-1/4-5/16, 1320RZ-3/8-7/16, 1320RZ-5/16-11/32		
1931Z-1/4, 1931Z-3/16, 1931Z-7/32		
1950MZ-3/8		
2058-BR		

Foam Inlay Socket Set for 4750RCHDW01 Heavy Duty Rigid Case - 45 Pcs



FF2B04

42 x 270 x 505 mm	1 FF2B04

BE-8020L, BE-8040		
BE-8080-10		
BE-8150, BE-8255		
BE-8610, BE-8620		
1544		
2509		
59/S28-4		
2535F2		
5516		
700-1.5-50, 700-1-50		
701-0-50, 701-00-50		
808050		
9070C		

Foam Inlay Pliers Set for 4750RCHDW01 Heavy Duty Rigid Case - 15 Pcs



FF2B05

35 x 270 x 510 mm	1 FF2B05

1150-1/2H/P	
MTB-3-16-M-E	
2101GC-125IP, 2101GC-160IP	
2427 GC-200IP	
2628 GC-160IP	
2650	
2820EF2	
2855	
4130	
4830	
5515T-52	
8224CIP	
BFLA01, 1179-FLX-2	

Foam Inlay Hammer and Punch Set for 4750RCHDW01 Heavy Duty Rigid Case - 6 Pcs



FF2B06

35 x 122 x 355 mm	1 FF2B06

3625N-32	
3734-5, 3734-8, 3734-3	
3735-5-120	
481-300	

Foam Inlay Wrench and Socket Set for 4750RCHDW01 Heavy Duty Rigid Case - 62 Pcs



FF2B07

35 x 270 x 505 mm	1 FF2B07

A6700DZ-1/2, A6700DZ-1/4, A6700DZ-11/32, A6700DZ-3/16, A6700DZ-3/8, A6700DZ-5/16, A6700DZ-7/16, A6700DZ-7/32, A6700DZ-9/16, A6700DZ-9/32		
A6710DZ-3/8, A6710DZ-5/16, A6710DZ-7/16		
A6800DZ-1/2, A6800DZ-1/4, A6800DZ-11/32, A6800DZ-3/16, A6800DZ-3/8, A6800DZ-5/16, A6800DZ-7/16, A6800DZ-7/32, A6800DZ-9/16, A6800DZ-9/32		
A7400DZ-1/2, A7400DZ-11/16, A7400DZ-13/16, A7400DZ-19/32, A7400DZ-3/4, A7400DZ-3/8, A7400DZ-5/8, A7400DZ-7/16, A7400DZ-7/8, A7400DZ-9/16		
A7402DZ-1/2, A7402DZ-11/16, A7402DZ-13/16, A7402DZ-19/32, A7402DZ-3/4, A7402DZ-3/8, A7402DZ-5/8, A7402DZ-7/16, A7402DZ-7/8, A7402DZ-9/16		
6950SL		
6954, 7764		
6956		
6960, 6962, 6962L		
6966		
6972H		
7407H, 7408H		
7750SL		
7752		
7760, 7761		
7762		
7765		
7766		
8164-1/2		

Foam Inlay Wrench Set for 4750RCHDW01 Heavy Duty Rigid Case - 25 Pcs



FF2B08

44 x 270 x 505 mm	1 FF2B08

1-100-04-2-2	
1-230-04-2-2	
111Z-1, 111Z-1/2, 111Z-1/4, 111Z-11/16, 111Z-3/4, 111Z-3/8, 111Z-5/16, 111Z-5/8, 111Z-7/16, 111Z-7/8, 111Z-9/16	
1177-SCRIBE	
1320RZ-1/2-9/16, 1320RZ-1/4-5/16, 1320RZ-3/8-7/16, 1320RZ-5/16-11/32	
1931Z-1/4, 1931Z-3/16, 1931Z-7/32	
1950MZ-3/8	
2058-BR	
208	
9031 C	



Foam Inlay Screwdriver Set for
4750RCHDW01 Heavy Duty Rigid Case
- 56 Pcs



FF2B09



47 x 270 x 505 mm

1 FF2B09

BE-8040, BE-8210		
BE-8150		
BE-8260		
BE-8600, BE-8610, BE-8620		
BE-9780		
MTB-3-16-E		
2047-1-5.5		
2047PR-1-2		
2509		
2535F2		
5515T-52		
59/S28-4		
BFLA01, 1179-FLX-2		
808050		

Foam Inlay Aviation Pliers Set for
4750RCHDW01 Heavy Duty Rigid Case
- 9 Pcs



FF2B10



37 x 270 x 505 mm

1 FF2B10

2101GC-160IP	
2427 GC-200IP	
2430 GC-200 IP	
2628 GC-160IP	
2650	
2744	
2855	
2979 D-180	
8224CIP	

Foam Inlay Striking Toolset for
4750RCHDW01 Heavy Duty Rigid Case
- 7 Pcs



FF2B11



39 x 122 x 355 mm

1 FF2B11

2632	
3625N-32	
3734-2, 3734-3, 3734-4, 3734-5	
481-300	

Foam Inlay Socket Set for 4750RCHDW01
Heavy Duty Rigid Case - 92 Pcs



FF2B12



44 x 270 x 505 mm

1 FF2B12

A6800DM-6, A6800DM-7, A6800DM-8, A6800DM-9, A6800DM-5.5, A6800DM-10, A6800DM-11, A6800DM-12, A6800DM-13		
A7402DM-19, A7402DM-15, A7402DM-16, A7402DM-17, A7402DM-18, A7402DM-11, A7402DM-12, A7402DM-13, A7402DM-14, A7402DM-10		
6700SM-5.5, 6700SM-6, 6700SM-11, 6700SM-12, 6700SM-13, 6700SM-7, 6700SM-8, 6700SM-9, 6700SM-10		
6709M-3, 6709M-4, 6709M-5, 6709M-6, 6709M-8		
6709PH-1, 6709PH-2, 6709PH-3		
6709TORX-T20, 6709TORX-T25, 6709TORX-T27, 6709TORX-T30, 6709TORX-T8, 6709TORX-T9, 6709TORX-T10, 6709TORX-T15, 6709TORX-T40		
6954, 7764		
6956		
6958		
6960, 6961, 6962, 6962L		
6966		
6972H		
7400SM-6, 7400SM-11, 7400SM-12, 7400SM-13, 7400SM-14, 7400SM-7, 7400SM-8, 7400SM-9, 7400SM-10, 7400SM-19, 7400SM-22, 7400SM-15, 7400SM-16, 7400SM-17, 7400SM-18		

7407H

7409M-8, 7409M-10, 7409M-4, 7409M-5,
7409M-6, 7409M-7, 7409M-3

7409TORX-T25, 7409TORX-T27,
7409TORX-T30, 7409TORX-T40,
7409TORX-T45, 7409TORX-T50

7750SL

7761, 7760

7762

7765

7766

8164-1/2

6950SL

Foam Inlay Wrench Set for
4750RCHDW01 Heavy Duty Rigid Case
- 39 Pcs



FF2B13



50 x 270 x 505 mm

1 FF2B13

BE-9770

111M-12, 111M-13, 111M-14, 111M-15,
111M-8, 111M-9, 111M-10, 111M-11,
111M-6, 111M-7, 111M-21, 111M-22,
111M-16, 111M-17, 111M-18, 111M-19

6M-6-7, 6M-8-9, 6M-10-11, 6M-12-13,
6M-14-15, 6M-16-17, 6M-18-19,
6M-20-22

9070C

1177-SCRIBE

2535F2

BFLA01

7758

7754

Foam Inlay Screwdriver Set for
4750RCHDW01 Heavy Duty Rigid Case
- 48 Pcs



FF2B14



35 x 270 x 505 mm

1 FF2B14

BE-8020L, BE-8030		
BE-8155		
BE-8260		
BE-8350		
BE-8601, BE-8602		
BE-8610, BE-8620		
BE-8630		
1544		
2047-0.8-4		
2047PR-1-2		
2058-BR		
2509		
808050P		
808050S		
59S/31-1		

Foam Inlay General Purpose Pliers Set for 4750RCHDW01 Heavy Duty Rigid Case - 9 Pcs



FF2B15

35 x 270 x 505 mm	1 FF2B15

1150-1/2H/P	
2101GC-160IP	
2427 GC-200IP	
2430 GC-200 IP	
2628 GC-160IP	
2820EF2	
5515T-52	
8224CIP	
MTB-3-16-M-E	

Foam Inlay Striking Set for 4750RCHDW01 Heavy Duty Rigid Case - 6 Pcs



FF2B16

34 x 122 x 355 mm	1 FF2B16

3625W-35	
3734-3, 3734-5, 3734-8	
3735-4-120	
481-300	

Foam Inlay 1/4" & 1/2" Socket Set & Multimeter for 4750RCHDW01 Heavy Duty Rigid Case - 51 pcs



FF2C01

45 x 390 x 530 mm	1 FF2C01

SBS81	
SL25	
BMMTRMS1	
S240	

CABINETS, PANELS & WORKBENCHES

1800 mm Tool Cabinets with Shutter General Purpose Toolkit - 110 Pcs



1495CS18TS1

900 x 170 x 1800 mm	1 1495CS18TS1

1495CS18	
981001100	
1495CS-AC1	
1495TP-AC10	

1500 mm Tool Cabinets with Shutter General Purpose Toolkit - 110 Pcs



1495CS15TS1

900 x 170 x 1500 mm	1 1495CS15TS1

1495CS15	
981001100	
1495CS-AC1	
1495TP-AC10	

Tool Cabinets with 2 Doors General Purpose Toolkit - 110 Pcs



1495CD60TS1

900 x 250 x 602 mm	1 1495CD60TS1

1495CD60	
981001100	
1495CD-AC1	
1495TP-AC10	



General Purpose Tool Kit - 109 pcs



981001100

109	27 kg	1	981001100

1546	
2521GC-160	
2630GC-180IP, 2630GC-200IP	
6M-12-13, 6M-14-15, 6M-10-11, 6M-6-7, 6M-8-9, 6M-20-22, 6M-21-23, 6M-24-27, 6M-25-28	
8150RN-1/2	
8154-1/2, 2421GC-160, 8160-1/2, 8162-1/2, 8166-1/2	
9048-400	
9-469-00-0-0	
1998M/10T	
3733-4	
3734-4	
814-100	
815-2-25, 815-1-100, 815-2-125	
9710-8-150, 9710-6.5-125	
2101GC-200HL	
2800-180	
SC127	
1-100-08-2-2, 1-100-10-2-2	
1150-1/2H/P	
2101D-140IP	
2535F1	
3906-300-24-2P	
2951-250	
2M-6-7, 2M-8-9, 2M-10-11, 2M-12-13, 2M-14-15, 2M-16-17, 2M-18-19, 2M-20-22, 2M-21-23, 2M-24-27	
3645-150-C	
4544-10	
813-3-75, 813-4-100, 813-5.5-125	
1-230-08-1-2	
2430 GC-160 IP	
3735-4-120	
2900-180	
3625W-35	
479-16	
869102500	
1-170-08-2-2	
1-210-08-2-2	
8072 C, 8071 C	
225-PLUS	
2427 GC-200IP	

3640-150-C

7800DM-18, 7800DM-17, 7800DM-16, 7800DM-11, 7800DM-10, 7800DM-15, 7800DM-14, 7800DM-13, 7800DM-12, 7800DM-19, 7800DM-23, 7800DM-22, 7800DM-21, 7800DM-20, 7800DM-24, 7800DM-26, 7800DM-28, 7800DM-30, 7800DM-32, 7800DM-27	
--	--

813VDE-3-100	
6224	

Wall or Bench Mount Cabinet with Shutter and Hooks



1495CS18HK

900 x 170 x 1800 mm	1 1495CS18HK
900 x 170 x 1800 mm	1 1495CS18BLHK

Wall or Bench Mount Cabinet with Shutter



1495CS1

900 x 170 x 1500 mm	1 1495CS15
900 x 170 x 1800 mm	1 1495CS18
900 x 170 x 1500 mm	1 1495CS15BL
900 x 170 x 1800 mm	1 1495CS18BL

2-Door Wall Mount Tool Cabinets



1495CD60

900 x 250 x 602 mm	1 1495CD60

2-Door Wheeled Tool Cabinets



1495CD60W

1605 x 450 x 625 mm	1 1495CD60W

Tool Panel Auto Repair Tool Kit - 62 pcs



1495TP-AUTO-M1

900 x 25 x 500 mm	1 1495TP-AUTO-M1

1495TP09	
BP910	
BP909TH	
BE-9678	
BE-9675	
29M-30	

2997-250	
1995LM-9, 1995LM-8, 1995LM-6	
3750	
1177-SCRIBE	
K7801M-9, K7801M-10, K7801M-11, K7801M-12, K7801M-13, K7801M-14, K7801M-15, K7801M-16, K7801M-17, K7801M-18, K7801M-19, K7801M-21, K7801M-22, K7801M-23, K7801M-24, K7801M-30, K7801M-32	
K7806M-15, K7806M-21, K7806M-24, K7806M-27	
K8901M-32, K8901M-34, K8901M-36	
K8964D	
K8167S	
K8160D-3	
2800-150	
2900-150	
3734S/6	
BE-8258TB	
1495TP-ACHL40x 9, 1495TP-ACHL65x 9, 1495TP-ACHL20x 33	

Tool Panel Auto Repair Tool Kit - 34 pcs



Tool Panel Auto Repair Tool Kit - 23 pcs



Tool Panel Auto Repair Tool Kit - 53 pcs

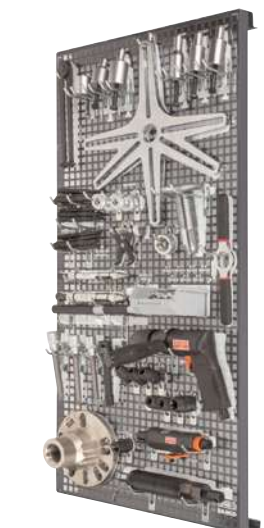

1495TP-AUTO-M3

900 x 25 x 500 mm 1 1495TP-AUTO-M3

1495TP09	
BE1GP5-T	
6968	
BE1SP1F	
BE6OF108	
BE6307414F	
BE6OFW	
BE1FFWF	
BE63064514F1	
BE6810Z, BE6810	
BE6FCP	
52	
1546	
2421GC-160, 7764, 6962-W, 6954, 8166-1/2	
5515M	
BE1P	
7455-60	
BE1FLD2, BE1FLD1, BE1FLD3	
BE65F65120	
8164-1/2	
BE6302712F	
BE6701VAG	
BE62110	
BE1310P427	
7406ZZ-21, 7406ZZ-16	
BE1SP14L	
BE1GP5	
1495TP-AC3	
1495TP-ACHL20x 38, 1495TP-ACHL40, 1495TP-ACHL65	

1495TP-AUTO-M2

900 x 25 x 500 mm 1 1495TP-AUTO-M2

1495TP09	
BE301	
K7801TORX-E10, K7801TORX-E12, K7801TORX-E14, K7801TORX-E16, K7801TORX-E18, K7801TORX-E20	
K8160D-2	
BE301CM	
BWHEPSSH8	
BE51038, BE510310, BE510312	
BP822	
BP825	
1495TP-ACHL40x 25, 1495TP-ACHL65x 4, 1495TP-ACHL20x 29	
1495TP-AC4	

1495TP-AUTO-M4

900 x 25 x 500 mm 1 1495TP-AUTO-M4

1495TP09	
BS618	
4545-N1, 4545-N11	
4545-1, 4545-2	
MTB-3-16	
361-14	
8900SM-41	
BS52	
8169-1/2, 8165-1/2	
747-22, 747-21, 747-19, 747-17, 747-15, 747-14, 747-13, 747-12	
BS40VAG	
BS56	
BS100PSA1	
BS45BMW	
1495TP-ACHL40x 10, 1495TP-ACHL65x 5, 1495TP-ACHL20x 20	



Tool Panel Auto Repair Tool Kit - 32 pcs



1495TP-AUTO-M5

900 x 25 x 500 mm 1 1495TP-AUTO-M5

1495TP09	
319	
484-1000	
SB3654BM-20	
3625S-44	
B192.004.200	
BE-8258TB	
2484/S4	
B194.030.150, B194.025.125, B194.020.100, B194.010.075	
600.005.012	
BBS165	
K7801TORX-E10, K7801TORX-E12, K7801TORX-E14, K7801TORX-E16, K7801TORX-E18, K7801TORX-E20, K7801TORX-E24	
BBR203P920, BBR203P925, BBR203P930, BBR203P940, BBR203P945, BBR203P950, BBR203P955, BBR203P960	
1495TP-ACHL40x 13, 1495TP-ACHL20x 38	
8226	

Tool Panel Auto Repair Tool Kit - 42 pcs

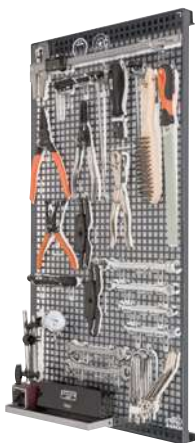

1495TP-AUTO-M6

900 x 25 x 500 mm 1 1495TP-AUTO-M6

1495TP09	
FM10	
782-U	
BBR405	
BBR400	
BBR210P3	
BBR6131	
BBR204	
BBR1501	
BBR501011, BBR50121314	
2900-215	
7823	
BBR100	
1154	
6M-16-17, 6M-14-15	
1949M-17-19, 1949M-12-13, 1949M-10-11, 1949M-8-9	
1495TP-ACHL40x 2, 1495TP-ACHL20x 29	
1495TP-AC3	

Heavy Duty Tool Hanger Panels with Reinforced Frame

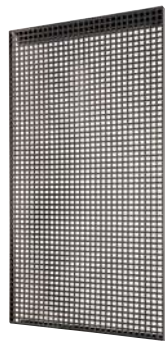

1495TP09

900 x 25 x 500 mm 1 1495TP09

Heavy Duty Tool Panels with Reinforced Frame

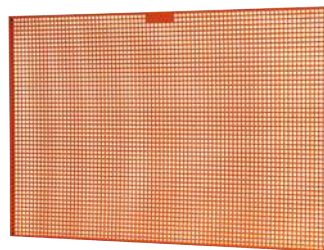

1495TP

500 x 23 x 600 mm	1	1495TP06
800 x 25 x 1200 mm	1	1495TP12
800 x 23 x 1500 mm	1	1495TP15
800 x 23 x 1800 mm	1	1495TP18

Hanging Rail for 1495TP09 Panels



1495TP09-RAIL

40 x 57 x 440 mm 1 1495TP09-RAIL

Tool Panel Adaptors for Wooden and MDF Workbench Tops



1495TP-AC1

9.5 kg 1 1495TP-AC1

Hook Kit for 1495 Cabinet and Panel - 24 Pcs

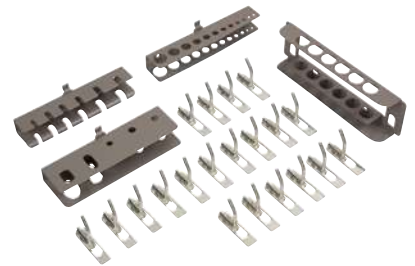

1495CD-AC1

1.22 kg 1 1495CD-AC1

Hook Kit for 1495 Cabinet and Panel - 35 Pcs

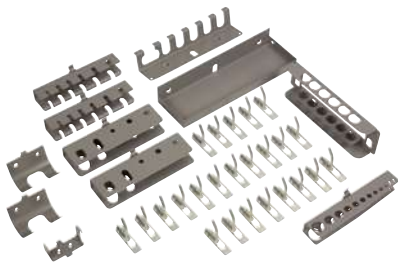

1495CS-AC1



2.11 kg



1 1495CS-AC1

Hammer 1-Slot Holders for Tool Panels



1495TP-AC12



0.07 kg



1 1495TP-AC12

Socket Hook and Tray Kit for Tool Panels



1495TP-AC3



0.45 kg



1 1495TP-AC3

Combination Wrenches 12-Slot Holders for Tool Panels



1495TP-AC10



0.43 kg



1 1495TP-AC10

T-Handle 1-Slot Holders for Tool Panels



1495TP-AC13



0.04 kg



1 1495TP-AC13

Plastic Trays for Tool Panels



1495TP-AC4



0.125 kg



1 1495TP-AC4

Screwdriver 6-Slot Hooks for Tool Panels

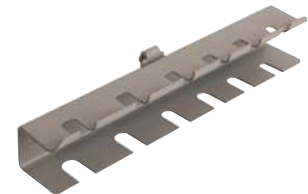

1495TP-AC5



0.14 kg



1 1495TP-AC5

Pin Punch 6-Slot Holders for Tool Panels

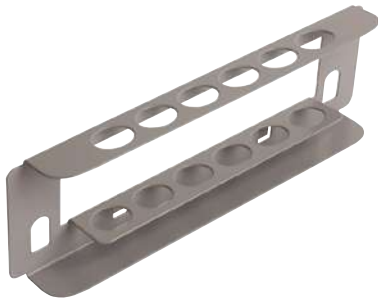

1495TP-AC11



0.16 kg



1 1495TP-AC11

Trays for Tool Panels



1495TP-AC2



0.44 kg



1 1495TP-AC2

Pliers 5-Slot Hooks for Tool Panels



1495TP-AC6



0.17 kg



1 1495TP-AC6



Grip 1-Slot Hooks for Tool Panels



1495TP-AC7

kg	
0.79 kg	1 1495TP-AC7

Hexagon 12-Slot L-Key Hooks for Tool Panels

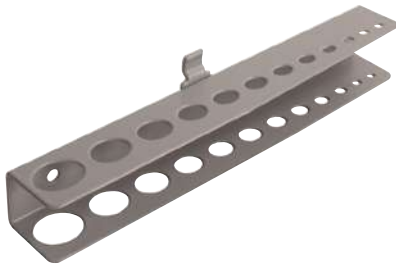

1495TP-AC8

kg	
0.12 kg	1 1495TP-AC8

Double Socket Wrench 12-Slot Hooks for Tool Panel



1495TP-AC9

kg	
0.43 kg	1 1495TP-AC9

L/U Shaped Hooks Set for Tool Panels - 5 Pcs



1495TP-ACH

kg	
0.116 kg	1 1495TP-ACHL20
0.125 kg	1 1495TP-ACHL40
0.144 kg	1 1495TP-ACHL65
0.17 kg	1 1495TP-ACHL90
0.102 kg	1 1495TP-ACHU20
0.125 kg	1 1495TP-ACHU40
0.146 kg	1 1495TP-ACHU65
0.162 kg	1 1495TP-ACHU90

Heavy Duty Steel Top Workbenches with Side Drawer Tower and 2-Leg 1800 mm x 750 mm x 1030 mm



1495KCWB18TS

1030 x 750 x 1800 mm	1 1495K6CWB18TS
1030 x 750 x 1800 mm	1 1495K7CWB18TS
1030 x 750 x 1800 mm	1 1495K8CWB18TS

Heavy Duty Steel Top Workbenches with Side Drawer Tower and 2-Leg 1500 mm x 750 mm x 1030 mm



1495KCWB15TS

1030 x 750 x 1500 mm	1 1495K6CWB15TS
1030 x 750 x 1500 mm	1 1495K7CWB15TS
1030 x 750 x 1500 mm	1 1495K8CWB15TS

Steel Top Kit for Convert 1475K Tool Trolley to Workbench



1495KW-TS

1030 x 750 x 1500 mm	1 1495KWB15TS
1030 x 750 x 1800 mm	1 1495KWB18TS

Heavy Duty Wooden Top Workbenches with Side Drawer Tower and 2-Leg 1800 mm x 750 mm x 1030 mm



1495KCWB18TW

1030 x 750 x 1800 mm	1 1495K6CWB18TW
1030 x 750 x 1800 mm	1 1495K7CWB18TW
1030 x 750 x 1800 mm	1 1495K8CWB18TW

Heavy Duty Wooden Top Workbenches with Side Drawer Tower and 2-Leg 1500 mm x 750 mm x 1030 mm



1495KCWB15TW

1030 x 750 x 1500 mm	1 1495K6CWB15TW
1030 x 750 x 1500 mm	1 1495K7CWB15TW
1030 x 750 x 1500 mm	1 1495K8CWB15TW

Heavy Duty Wooden Countertop Kit for Convert 1475k Series Trolley to Workbench



1495KWB-TW



1030 x 750 x 1500 mm 1 1495KWB15TW
1030 x 750 x 1800 mm 1 1495KWB18TW

Heavy Duty Steel Top Workbenches with 4-Leg



1495WB-TS



1030 x 750 x 1500 mm 1 1495WB15TS
1030 x 750 x 1800 mm 1 1495WB18TS
1030 x 750 x 1500 mm 1 1495WB15TSBL
1030 x 750 x 1800 mm 1 1495WB18TSBL

Drawers with Trays or Dividers for 1495WB Workbenches



1495WB-AC



105 x 500 x 500 mm 1 1495WB-AC1

Heavy Duty Steel Top Workbenches & Bottom Tray with 4 Legs - 1800 mm



1495WB18TSBT



1030 x 750 x 1800 mm 1 1495WB18TSBT

Heavy Duty Chestnut Top Workbenches with 4-Leg



1495WB-TW



1030 x 750 x 1500 mm 1 1495WB15TW
1030 x 750 x 1800 mm 1 1495WB18TW

Galvanized Top Foldable Workbenches



1495FWBTS



840 x 510 x 1200 mm 1 1495FWB120TS

Heavy Duty Steel Top Workbenches & Bottom Tray with 4 Legs - 1500 mm



1495WB15TSBT



1030 x 750 x 1500 mm 1 1495WB15TSBT

Steel Bottom Trays for 1495WB Workbenches



1495WB1-AC



30 x 504 x 1500 mm 1 1495WB15-AC1
30 x 504 x 1800 mm 1 1495WB18-AC1

METALLIC TOOL BOXES

Metallic Tool Box Aviation Toolkit - 129 Pcs



1483KHD3RB-FF1



335 x 260 x 565 mm 1 1483KHD3RB-FF1

1483KHD3RB

FF3A01

FF3A02

FF3A03

FF3A04



Metallic Tool Box Aviation Toolkit - 152 Pcs



1483KHD3RB-FF2



335 x 260 x 565 mm



1 1483KHD3RB-FF2

1483KHD3RB	
FF3A05	
FF3A06	
FF3A07	
FF3A08	
2509	
2535F2	
3625N-32	
481-400	
7762	

Metallic Tool Box General Purpose Toolkit - 193 Pcs



1483KHD3RB-FF3



335 x 260 x 565 mm



1 1483KHD3RB-FF3

1483KHD3RB	
FF3A09	
FF3A10	
FF3A11	
FF3A12	

Metallic Tool Box General Purpose Toolkit - 146 Pcs



1483KHD3RB-FF4



335 x 260 x 565 mm



1 1483KHD3RB-FF4

1483KHD3RB	
FF3A10	
FF3A11	
FF3A12	
FF3A13	

Metallic Tool Box Aviation Toolkit - 137 Pcs



1483KHD3RB-FF5



335 x 260 x 565 mm



1 1483KHD3RB-FF5

1483KHD3RB	
FF3A14	
FF3A15	
FF3A16	
FF3A17	

Metallic Tool Box Aviation Tool Kit - 124 pcs



1483KHD3RB-FF7



335 x 260 x 565 mm



1 1483KHD3RB-FF7*

1483KHD3RB	
481-400	
2535F1	
7762	
6950SL	
6960, 6962	
6956	
7752	
6966	
6972H	
A6700DZ-3/16, A6700DZ-7/32, A6700DZ-1/4, A6700DZ-9/32, A6700DZ-5/16, A6700DZ-11/32, A6700DZ-3/8, A6700DZ-7/16, A6700DZ-1/2, A6700DZ-9/16	
A6710DZ-1/4, A6710DZ-5/16, A6710DZ-11/32, A6710DZ-3/8, A6710DZ-7/16	
A6800DZ-3/16, A6800DZ-7/32, A6800DZ-1/4, A6800DZ-9/32, A6800DZ-5/16, A6800DZ-11/32, A6800DZ-3/8, A6800DZ-7/16, A6800DZ-1/2, A6800DZ-9/16	
A6800DM-4	
BE-9780	
59/S28-4	
59S/TS-1/4	
9070 P	
808050	
2058-BR	
KE18-01	
1150-1/2H/P	
2047-1-5.5	
2047PR-1-2	
BE-8030	
BE-8150	
BE-8260	
BE-8350	
BE-8602	

BE-8610, BE-8620		
5515T-52		
1177-SCRIBE		
SR300-E		
704Z-3/32		
MTB-3-16-M-E		
2101GC-160IP		
2427 GC-200IP		
2855		
8224CIP		
2628 GC-160IP		
2632		
3734-3, 3734-5, 3734-8		
1300Z-1/4-5/16		
1320RZ-1/4-5/16, 1320RZ-3/8-7/16		
1952Z-15/16, 1952Z-1, 1952Z-1/4, 1952Z-5/16, 1952Z-11/32, 1952Z-3/8, 1952Z-7/16, 1952Z-1/2, 1952Z-9/16, 1952Z-5/8, 1952Z-11/16, 1952Z-3/4, 1952Z-13/16, 1952Z-7/8		
6Z-19/32-11/16		
3625N-32		

Heavy Duty Metallic Tool Boxes with 3 Drawers



1483KHD3RB

305 x 233 x 523 mm	13050 g	1	1483KHD3RB

Metallic Tool Boxes with 3 Drawers



1483K3RB

334 x 260 x 523 mm	10200 g	1	1483K3RB

Heavy Duty Metallic Tool Boxes with 4 Drawers



1483KHD4RB

390 x 260 x 593 mm	15200 g	1	1483KHD4RB

Metallic Tool Boxes with 2 Drawers



1483K2RB

277 x 257 x 525 mm	8200 g	1	1483K2RB

Heavy Duty Metallic Tool Boxes with 3 Drawers



1484THD3RB

300 x 220 x 520 mm	12.40 kg	1	1484THD3RB

Carts for 1483K Metallic Boxes



1483CART

200 x 270 x 655 mm	6.02 kg	1	1483CART

Foam Inlay Imperial Toolset for our metallic cases 1483K & 1483KHD Series - 79 Pcs



FF3A01

64 x 245 x 505 mm	1	FF3A01

A6700DZ-1/2, A6700DZ-1/4, A6700DZ-11/32, A6700DZ-3/8, A6700DZ-5/16, A6700DZ-7/16, A6700DZ-7/32, A6700DZ-9/32		
A6710DZ-3/8, A6710DZ-5/16, A6710DZ-7/16		
A6800DZ-1/4, A6800DZ-5/16, A6800DZ-7/32, A6800DZ-9/32		
A7400DM-10, A7400DM-13		
A7400DZ-1/2, A7400DZ-11/16, A7400DZ-3/4, A7400DZ-5/8, A7400DZ-9/16		
A7402DZ-1/2, A7402DZ-3/8, A7402DZ-7/16, A7402DZ-9/16		
1320RZ-1/4-5/16, 1320RZ-3/8-7/16		
59/S28-4		
6Z-1.1/16-1.1/4, 6Z-1-1.1/8, 6Z-7/8-15/16		
6950SL		
6956		
6958		
6960, 6961		
6966		
6972H		
7407H		
7750SL		
7752		
7760, 7761		
7764		
7765		
7766		
7800DZ-1, 7800DZ-13/16, 7800DZ-7/8		
8164-1/2		
8171		

* Until stocks last



Foam Inlay Imperial Toolset for our metallic cases 1483K & 1483KHD Series - 13 Pcs



FF3A02



39 x 210 x 445 mm



1 FF3A02

BE-3529	
BE-8020L	
BE-8155	
BE-8260	
BE-8601	
BE-8611, BE-8621	
1150-1/2H/P	
1177-SCRIBE	
2047-1.2-8	
2047PR-1-2	
5515T-52	
9715-14-250	

Foam Inlay Imperial Toolset for our metallic cases 1483K & 1483KHD Series - 12 Pcs



FF3A03



48 x 210 x 450 mm



1 FF3A03

MTB-3-16-M-E	
2101GC-160IP	
2421GC-180IP	
2855 D	
3658A-2, 3658A-3, 3658A-5	
8224CIP	
0454800500, 1151-1, 1151-2, BFLB01	

Foam Inlay Imperial Toolset for our metallic cases 1483K & 1483KHD Series - 20 Pcs



FF3A04



45 x 210 x 445 mm



1 FF3A04

U-XID1415A, U-XID1618A, U-DS2018A

1300Z-1/2-9/16, 1300Z-1/4-5/16,
1300Z-3/8-7/16, 1300Z-5/8-3/4, 1300Z-
7/8-15/16, 1300Z-25/32-13/16, 1300Z-
19/32-11/16

6Z-19/32-11/16, 6Z-25/32-13/16,
6Z-3/8-7/16, 6Z-5/8-3/4, 6Z-1/4-5/16,
6Z-1/2-9/16

9070C

1931Z-7/32, 1931Z-1/4

8157-15

Foam Inlay Imperial Toolset for our metallic cases 1483K & 1483KHD Series - 98 Pcs



FF3A05



60 x 245 x 510 mm



1 FF3A05

A6700DZ-1/2, A6700DZ-1/4,
A6700DZ-11/32, A6700DZ-3/16,
A6700DZ-3/8, A6700DZ-5/16,
A6700DZ-7/16, A6700DZ-7/32,
A6700DZ-9/16, A6700DZ-9/32

A6710DZ-1/4, A6710DZ-11/32,
A6710DZ-3/8, A6710DZ-5/16,
A6710DZ-7/16

A6800DM-4

A6800DZ-1/2, A6800DZ-1/4,
A6800DZ-11/32, A6800DZ-3/8,
A6800DZ-5/16, A6800DZ-7/16,
A6800DZ-3/16, A6800DZ-7/32,
A6800DZ-9/16, A6800DZ-9/32

A7400DZ-1/2, A7400DZ-11/16,
A7400DZ-13/16, A7400DZ-17/32,
A7400DZ-19/32, A7400DZ-3/4,
A7400DZ-5/8, A7400DZ-9/16

59/S28-4

BE-9780

KE18-01

1544

2058-BR, 7764

59S/TS-1/4

6950SL

6956

6960, 6962

6966

6972H

7407H

7752

7750SL

7760, 7761

7765

7766

808050

9071C

8164-1/2

Foam Inlay Imperial Toolset for our metallic cases 1483K & 1483KHD Series - 16 Pcs



FF3A06



40 x 205 x 450 mm



1 FF3A06

BE-8030	
BE-8150, BE-8155	
BE-8260	
BE-8350	
BE-8602	
BE-8610, BE-8620	
1177-SCRIBE	
2047-1-5.5	
2047PR-1-2	
5515T-52	
704Z-3/32	
1150-1/2H/P	
1179-FLX-2	

Foam Inlay Imperial Toolset for our metallic cases 1483K & 1483KHD Series - 11 Pcs



FF3A07



39 x 202 x 450 mm



1 FF3A07

MTB-3-16-E	
2101GC-160IP	
2427 GC-200IP	
2628 GC-160IP	
2632	
2650	
2855	
3734-3, 3734-5, 3734-8	
8224CIP	

Foam Inlay Imperial Toolset for our metallic cases 1483K & 1483KHD Series - 23 Pcs



FF3A08



43 x 205 x 450 mm



1 FF3A08

1320RZ-1/2-9/16, 1320RZ-5/16-11/32, 1320RZ-1/4-5/16, 1320RZ-3/8-7/16	
1952Z-1/2, 1952Z-1/4, 1952Z-11/16, 1952Z-11/32, 1952Z-13/16, 1952Z-3/4, 1952Z-3/8, 1952Z-5/16, 1952Z-5/8, 1952Z-7/16, 1952Z-7/8, 1952Z-9/16	
6Z-19/32-11/16, 6Z-1/2-9/16, 6Z-1/4-5/16, 6Z-13/16-7/8, 6Z-3/8-7/16, 6Z-5/16-11/32, 6Z-5/8-3/4	

Foam Inlay Metric Toolset for our metallic cases 1483K & 1483KHD Series - 95 Pcs



FF3A09



65 x 250 x 515 mm



1 FF3A09

A6800DM-7, A6800DM-6, A6800DM-5.5, A6800DM-11, A6800DM-10, A6800DM-9, A6800DM-8, A6800DM-13, A6800DM-12	
A7402DM-19, A7402DM-18, A7402DM-17, A7402DM-12, A7402DM-11, A7402DM-10, A7402DM-16, A7402DM-15, A7402DM-14, A7402DM-13	
1544	
2058-BR, 6954, 7764	
6700SM-8, 6700SM-7, 6700SM-6, 6700SM-5.5, 6700SM-12, 6700SM-11, 6700SM-10, 6700SM-9, 6700SM-13	
6709M-8, 6709M-6, 6709M-5, 6709M-4, 6709M-3	
6709PH-2, 6709PH-1, 6709PH-3	
6709TORX-T25, 6709TORX-T20, 6709TORX-T15, 6709TORX-T10, 6709TORX-T40, 6709TORX-T30, 6709TORX-T27, 6709TORX-T9, 6709TORX-T8	
6950SL	
6956	
6958	
6960, 6961, 6962, 6962L	
6966	
6972H	
7400SM-8, 7400SM-7, 7400SM-6, 7400SM-19, 7400SM-18, 7400SM-17, 7400SM-22, 7400SM-12, 7400SM-11, 7400SM-10, 7400SM-9, 7400SM-16, 7400SM-15, 7400SM-14, 7400SM-13	
7407H	
7409M-10, 7409M-8, 7409M-7, 7409M-6, 7409M-5, 7409M-4, 7409M-3	
7409TORX-T27, 7409TORX-T25, 7409TORX-T50, 7409TORX-T45, 7409TORX-T40, 7409TORX-T30	
7750SL	
7754, 7760, 7761	
7758	
7765	
7766	
8164-1/2	

Foam Inlay Metric Toolset for our metallic cases 1483K & 1483KHD Series - 53 Pcs



FF3A10



39 x 205 x 445 mm



1 FF3A10

BE-8020L, BE-8030	
BE-8155	
BE-8260	
BE-8350	
BE-8601, BE-8602	
BE-8610, BE-8620	
BE-9770	
2047-0.8-4	
2047PR-1-2	
808050P	
808050S	
59S/31-1	

Foam Inlay Metric Toolset for our metallic cases 1483K & 1483KHD Series - 12 Pcs



FF3A11



39 x 205 x 445 mm



1 FF3A11

1150-1/2H/P	
MTB-3-16	
1177-SCRIBE	
2101GC-160IP	
2427 GC-200IP	
2430 GC-200 IP	
2628 GC-160IP	
3734-3, 3734-5, 3734-8	
3735-4-120	
8224CIP	



Foam Inlay Metric Toolset for our metallic cases 1483K & 1483KHD Series - 28 Pcs



FF3A12



45 x 205 x 450 mm

1 FF3A12

111M-6, 111M-21, 111M-19, 111M-18, 111M-22, 111M-13, 111M-12, 111M-11, 111M-10, 111M-17, 111M-16, 111M-15, 111M-14, 111M-9, 111M-8, 111M-7

2820EF2

5515T-52

6M-10-11, 6M-6-7, 6M-12-13, 6M-8-9, 6M-14-15, 6M-16-17, 6M-18-19, 6M-20-22

BFLA01

9070C

Foam Inlay Metric Toolset for our metallic cases 1483K & 1483KHD Series - 49 Pcs



FF3A13



68 x 245 x 525 mm

1 FF3A13

111M-27, 111M-32, 111M-24, 111M-30

6M-24-27, 6M-30-32

7800SM-19, 7800SM-18, 7800SM-17, 7800SM-16, 7800SM-22, 7800SM-21, 7800SM-11, 7800SM-10, 7800SM-15, 7800SM-14, 7800SM-13, 7800SM-12, 7800SM-27, 7800SM-32, 7800SM-30, 7800SM-24

7807H

7809M-10, 7809M-12, 7809M-14, 7809M-19, 7809M-17, 7809M-5, 7809M-8, 7809M-6, 7809M-7

7809TORX-T50, 7809TORX-T45, 7809TORX-T60, 7809TORX-T55, 7809TORX-T25, 7809TORX-T20, 7809TORX-T40, 7809TORX-T30, 7809TORX-T27

8150SL

8164-1/2

8154-11

8160-5, 8160-10

8171

8166

8172

Foam Inlay Imperial Toolset for our metallic cases 1483K & 1483KHD Series - 77 Pcs



FF3A14



65 x 247 x 510 mm

1 FF3A14

A6700DZ-1/2, A6700DZ-1/4, A6700DZ-3/8, A6700DZ-5/16, A6700DZ-7/16, A6700DZ-7/32, A6700DZ-9/16, A6700DZ-9/32, A6700DZ-11/32

A6800DZ-1/4, A6800DZ-5/16, A6800DZ-7/32, A6800DZ-9/32

A7400DM-10, A7400DM-13

A7400DZ-1/2, A7400DZ-11/16, A7400DZ-13/16, A7400DZ-3/4, A7400DZ-5/8, A7400DZ-7/8, A7400DZ-9/16

A7402DZ-1/2, A7402DZ-3/8, A7402DZ-7/16, A7402DZ-9/16

111Z-1, 111Z-1.1/8

59/S28-4

6Z-1.1/16-1.1/4, 6Z-1-1.1/8

6Z/8C

6950SL

6958

6960, 6961

6966

6972H

7407H, 7408H

7750SL

7752

7760, 7761

7764

7765

7766

7800DZ-1, 7800DZ-15/16

8164-1/2

1952Z-15/16

8171

Foam Inlay Imperial Toolset for our metallic cases 1483K & 1483KHD Series - 14 Pcs



FF3A15



40 x 210 x 445 mm

1 FF3A15

BE-3529

BE-8020L

BE-8155

BE-8260

BE-8601, BE-8602

BE-8611, BE-8621

1177-SCRIBE

2047-1.2-8

2047PR-1-2

5515T-52

1179-FLX-2

9715-14-250

Foam Inlay Imperial Toolset for our metallic cases 1483K & 1483KHD Series - 12 Pcs



FF3A16



42 x 210 x 445 mm

1 FF3A16

MTB-3-16-E

2101GC-160IP

2421GC-180IP

3658A-3, 3658A-5, 3658A-8

3735-5-120

3740-150

8224CIP

2855 D

0454800500, BFLB01

Foam Inlay Imperial Toolset for our metallic cases 1483K & 1483KHD Series - 30 Pcs



FF3A17

48 x 205 x 450 mm	1 FF3A17

BE-9780	
KE18-01	
1300Z-1/4-5/16, 1300Z-3/8-7/16	
1320RZ-1/4-5/16, 1320RZ-3/8-7/16	
1931Z-1/4, 1931Z-7/32	
1952Z-1/2, 1952Z-11/16, 1952Z-11/32, 1952Z-13/16, 1952Z-3/4, 1952Z-5/8, 1952Z-7/8, 1952Z-9/16	
2628 GC-180IP	
7758	
U-DS2018A, U-XID1415A, U-XID1618A	

Cantilever Metallic Box with Foams General Purpose Tool Kit - 69 pcs



3149-ORFF1

220 x 220 x 560 mm	1 3149-ORFF1

111M-19, 111M-18, 111M-17, 111M-16, 111M-15, 111M-14, 111M-13, 111M-12, 111M-11, 111M-10, 111M-8, 111M-9	
2953-250	
224 D	
2171G-160	
2470 G-200	
BE-9770	
611-3.5-75, 611-5.5-125, 611-6.5-150	
613-3-100, 613-4-125	
615-2-25, 615-1-100, 615-2-125, 615-3-150	
KBSK-01	
MTG-5-19-E	
482-30	

3625W-28	
3745-150	
3740-150	
3734-3, 3734-5	
3735-5-120	
3149-OR	
2678 G-200	
8160-10, 8160-5	
8158-10	
SBS81	
8166	
7772H	
7800SM-15, 7800SM-16, 7800SM-13, 7800SM-14, 7800SM-19, 7800SM-20, 7800SM-17, 7800SM-18, 7800SM-23, 7800SM-24, 7800SM-21, 7800SM-22, 7800SM-27, 7800SM-32, 7800SM-30, 7800SM-11, 7800SM-12, 7800SM-10	

Cantilever Metallic Box General Purpose Tool Kit - 69 pcs



3149-ORTS1

220 x 220 x 560 mm	1 3149-ORTS1

111M-19, 111M-18, 111M-17, 111M-16, 111M-15, 111M-14, 111M-13, 111M-12, 111M-11, 111M-10, 111M-9, 111M-8	
S240	
2953-250	
224 D	
2171G-160	
2678 G-200	
2470 G-200	
BE-9770	
611-3.5-75, 611-5.5-125, 611-6.5-150	
613-3-100, 613-4-125	
615-2-25, 615-1-100, 615-2-125, 615-3-150	
KBSK-01	
MTG-5-19-E	
482-30	
3625W-28	
3745-150	
3740-150	
3734-3, 3734-5	
3735-5-120	
3149-OR	

Wheeled Cantilever Metallic Tool Box



1497MBW

549 x 400 x 1213 mm	250 kg	1 1497MBW

Metallic Tool Boxes with 5 Compartments and Locking Capability



3149-OR

200 x 220 x 530 mm	4370 g	1 3149-OR

Cantilever Style Tool Boxes with 7 Compartments



1497MBF750

250 x 200 x 530 mm	15 kg	1 1497MBF750



Cantilever Style Tool Boxes with 5 Compartments



1497MBF550

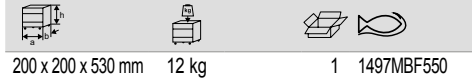

200 x 200 x 530 mm 12 kg 1 1497MBF550

Mason Tool Chests 530 mm x 290 mm x 290 mm



1496MB2

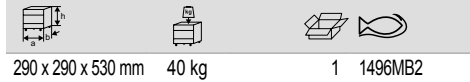

290 x 290 x 530 mm 40 kg 1 1496MB2

Mason Tool Chests 910 mm x 530 mm x 530 mm



1496MB5

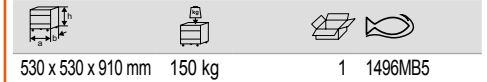

530 x 530 x 910 mm 150 kg 1 1496MB5

Cantilever Style Tool Boxes with 3 Compartments



1497MBF350

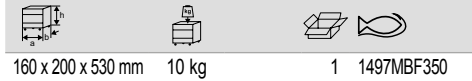

160 x 200 x 530 mm 10 kg 1 1497MBF350

Mason Tool Chests 690 mm x 360 mm x 310 mm



1496MB3

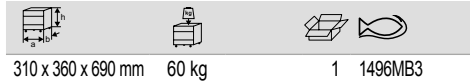

310 x 360 x 690 mm 60 kg 1 1496MB3

Mason's Tool Chests 100 mm x 170 mm x 573 mm



1497MB08

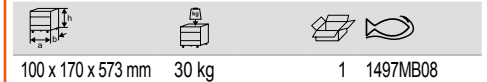

100 x 170 x 573 mm 30 kg 1 1497MB08

Metallic Tool Boxes with 3/5 Compartments and Locking Capability



9601



190 x 210 x 300 mm	2450 g	1	960100010
190 x 210 x 400 mm	3400 g	1	960100020
190 x 210 x 500 mm	3670 g	1	960100030
245 x 210 x 400 mm	4400 g	1	960100050
245 x 210 x 500 mm	4840 g	1	960100060

Mason Tool Chests 830 mm x 440 mm x 340 mm



1496MB4

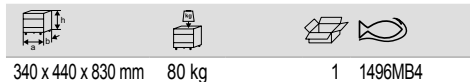

340 x 440 x 830 mm 80 kg 1 1496MB4

Mason's Tool Chests 100 mm x 230 mm x 605 mm



1497MB13



100 x 230 x 605 mm 1 1497MB13

Mason's Tool Chests 122 mm x 270 mm x 640 mm



1497MB18



122 x 270 x 640 mm 30 kg 1 1497MB18

PLASTIC BOXES & CASES

670 mm Heavy Duty Plastic Tool Boxes



4750PTBW67



420 x 472 x 675 mm 50 kg 1 4750PTBW67

470 mm Heavy Duty Plastic Tool Boxes



4750PTBW47



60 l 30 kg 1 4750PTBW47

650 mm Heavy Duty Plastic Tool Boxes



4750PTB65



285 x 300 x 650 mm 2 4750PTB65

600 mm Heavy Duty Plastic Tool Boxes



4750PTB60



37 l 20 kg 3 4750PTB60

500 mm Heavy Duty Plastic Tool Boxes



4750PTB50



27 l 20 kg 3 4750PTB50

Double Wall Shock Absorbing Case



4750BMC



51 x 117 x 260 mm	1	4750BMC3
67 x 214 x 230 mm	1	4750BMC4
70 x 230 x 280 mm	1	4750BMC5
90 x 230 x 320 mm	1	4750BMC5.5
76 x 256 x 355 mm	1	4750BMC7
80 x 287 x 380 mm	1	4750BMC9
84 x 341 x 450 mm	1	4750BMC10

Plastic Tool Box General Purpose Tool Kit - 37 pcs



4750PTB65TS5



285 x 300 x 650 mm 1 4750PTB65TS5

2430 D-140 IP

2630D-160

MT-TS-3

9572

BE-9884

2446

SL25

427-16



Blow Mould Case with Adjustable Torque Wrench and Impact Socketry Toolkit - 11 pcs



4750BMC10FF1

84 x 341 x 447 mm 1 4750BMC10FF1

4750BMC10	
BWSHK21	
BWSMB15	
BWSMB17	
BWSS12P5	
BWTVCTT355	
74W9-200	
9R-1/2	

TEXTILE & LEATHER EQUIPMENT

Wheeled Textile Bag MRO Toolkit - 72 Pcs



4750FB2W-TS001

390 x 400 x 685 mm 1 4750FB2W-TS001

4750FB2W-24A	
SL25	
BE-8030, BE-8242	
S240	
BE-8155	
BE-8600, BE-8610, BE-8620	
BE-8800, BE-8810, BE-8820	

BE-8040S	
2628 G-180	
2101G-180	
7224	
1520 G	
MTB-5-25	
MA421	
268	
325	
479-16	
KERU-01	
BFLA01	
5515T	
9071	

Closed Top Bag MRO Toolkit - 61 Pcs



4750FB2-19TS001

500 mm 250 mm 1 4750FB2-19TS001

4750FB2-19A	
BE-8010S, BE-8040S, BE-8050S, BE-8220S	
BE-8610S, BE-8620S, BE-8630S	
BE-8800S, BE-8820S, BE-8830S	
706-4	
PC-12-VEN	
1-210-08-2-2	
2101G-180	
2233 D-200	
2628 G-180	
268	
3830-20-VIP, 3830-25-VIP	
3834-ARBR-730	
4130	
424P-16, 424P-20, 424P-25	
428-16	
484-1250	
806-1-1	
8231	
9031	
SL25	

Fabric Tool Bag Service Engineer's Toolkit - 51 Pcs



4750FB4-18TS001

450 mm 190 mm 1 4750FB4-18TS001

4750FB4-18	
2101G-160	
2628 G-180	
2430 G-160	
1RM/SH8	
7223	
2233 D-200	
SL25	
9070	
9031	
483-20	
BE-8020, BE-8040	
BE-8150, BE-8155	
BE-8610, BE-8620	
SC127	
SQZ150003	
BE-9777	
MTB-5-25	

Leather Bag Electrician Toolkit - 16 Pcs



982000170

290 x 195 x 440 mm 1 982000170

4750-FOLTC-1	
2101GC-160IP	
2800 N	
2630GC-160IP	
2421GC-160	
2521GC-160	
8071 C IP	
B196.065.150, B196.055.125, B196.030.100, B196.040.100	
B197.002.100, B197.001.080	
SC127	
2820EF2	
MTB-3-16	
6224	

Leather Bag General Purpose Toolkit - 32 Pcs



982000320

280 x 200 x 435 mm 1 982000320

4750-FOLTC-1	
2101D-160IP	
224 D	
2630D-180	
2430 D-160 IP	
8071 C IP	
483-20	
6M/8C	
541D-180	
2951-180	
B191.030.075, B191.040.100	
B190.100.200, B190.065.150	
B192.001.100, B192.002.125	
SC127	
2820EF2	
BE-9777	
MTB-3-16	

Leather Bag General Purpose Toolkit - 34 Pcs



982000350

280 x 200 x 440 mm 1 982000350

4750-FOLTC-1	
2101GC-160IP	
2630GC-180IP	
2900-180	
2800-180	
1998M/10T	
8072 C IP	
2951-250	
B190.100.200, B190.065.150, B190.040.100	
B192.001.100, B192.002.125	
SC127	
6M/8C	
479-16	
2430 GC-200 IP	
1-110-08-2-2	
6224	

Fabric tool folder with foam, 51 pcs



4750FB5BFF1

62 x 275 x 330 mm 1 4750FB5BFF1

4750FB5B	
808050P	

MTB-5-25	
2101G-160	
2628 G-180	
BE-9578	
9070	
59/S31B	

Mini Folder Case General Purpose Toolkit - 36 Pcs



4750FB5ATS001

275 mm 170 mm 1 4750FB5ATS001

4750FB5A	
2058/S26	
808050	
8070	
2101G-160	
2628 G-180	

Zipper Wallet General Purpose Toolkit - 7 Pcs



9848

50 x 275 x 330 mm 1 9848

8160	
7890	
8070	
BE-8020, BE-8040	
BE-8610	
TL AA-SA-SL	



Zipper Wallet Electrician Toolkit - 17 Pcs



9852



360 x 40 x 240 mm

1 9852

7890		
8160		
8070		
TL AA-SA-SL		
2421 G-160		
2101G-160		
2628 G-180		
BE-8210, BE-8040		
BE-8150, BE-8155		
BE-8600, BE-8610, BE-8620		
8045LVDE		
K-AP-1		

Zipper Wallet Electrician Toolkit - 7 Pcs



9841



275 x 48 x 330 mm

1 9841

7190		
7890		
TL AA-SA-SL		
BE-8020, BE-8040		
BE-8610		
8070		

Backpack with Anti-Slip Plastic Hard Bottom



4750FB8



560 x 190 x 335 mm

4 4750FB8

32 L Open Top Deluxe Fabric Tool Bags with Rigid Base



4750FB1-19B



365 x 225 x 480 mm

4 4750FB1-19B

24 L Open Top Fabric Tool Bags with Rigid Base



3100TB



345 x 240 x 485 mm

1 3100TB

32 L Closed Top Fabric Tool Bags with Rigid Base



4750FB2-19A



370 x 230 x 470 mm

4 4750FB2-19A

32 L Open Top Fabric Tool Bags with Rigid Base



4750FB1-19A



355 x 230 x 470 mm

1 4750FB1-19A

48 L Closed Top Fabric Tool Bags with Rigid Base



4750FB2-24A



380 x 260 x 600 mm

2 4750FB2-24A

73 L Wheeled Fabric Tool Bags with Telescopic Handle



4750FB2W-24A



385 x 325 x 665 mm

1 4750FB2W-24A

21 L Closed Top Fabric Tool Bags



4750FB6-13



275 x 250 x 310 mm

1 4750FB6-13

2.4 L Mini Fabric Tool Folders



4750FB5A



50 x 168 x 273 mm

1 4750FB5A

12 L Electrician Fabric Tool Bags



4750FB3-12



285 x 190 x 285 mm

1 4750FB3-12

36 L Closed Top Fabric Tool Bags



4750FB6-19



290 x 265 x 480 mm

1 4750FB6-19

6 L Medium Fabric Tool Folders with Rubberized Handle



4750FB5B



62 x 275 x 330 mm

1 4750FB5B

17 L Laptop and Tool Bags



4750FB4-18



350 x 150 x 430 mm

4 4750FB4-18

Fabric Tool Bags for 416-SET-1



4750-LV-1



85 x 43 x 1800 mm

1 4750-LV-1

51 x 43 x 1800 mm

1 4750-LV-2

12 L Max Fabric Tool Folders with Rubberized Handle



4750FB5C



80 x 305 x 403 mm

8 4750FB5C



8 L Fabric Tool Folder with Rubberised Handle for 1x 1/3 Fit&Go Foam



4750FB5-FG1



65 x 210 x 470 mm

1 4750FB5-FG1

Tube Style Leather Tool Cases



4750-TOCST-1



220 x 170 x 495 mm

1 4750-TOCST-1

Zip Bags 3 Units Set - 90 mm



4750FB7-01



135 x 10 x 215 mm

60 4750FB7-01

11 L Fabric Tool Folder with Rubberised Handle for 2x 1/3 Fit&Go Foams



4750FB5-FG2



90 x 210 x 470 mm

1 4750FB5-FG2

Electrician Leather Tool Cases



4750-VDEC



290 x 190 x 445 mm

1 4750-VDEC

Black Leather Secateur Holster



PROF-TL



30 x 90 x 245 mm

4 PROF-TL

Folding Front Leather Tool Cases



4750-FOLTC-1



290 x 195 x 440 mm

1 4750-FOLTC-1

Three-Pouch Belt Set for Waist up to 48"



4750-3PB



234 x 105 x 570 mm

1 4750-3PB-1

Zip Bags 3 Units Set - 145 mm



4750FB7-02



205 x 10 x 310 mm

60 4750FB7-02

Orange Zip Bag - 90 mm



4750FB7ORLT



135 x 10 x 215 mm



120 4750FB7ORLT

Orange Zip Bag - 145 mm



4750FB7ORBG



205 x 10 x 310 mm



120 4750FB7ORBG

Heavy Duty Belts with Cushion and Stainless Steel Twin-Pin Buckle



4750-HDB-2



190 x 50 x 900 mm



1 4750-HDB-2

Heavy Duty Belt Set



4750-HDBS-2



330 x 170 x 900 mm



1 4750-HDBS-2

Heavy Duty Leather Belts



4750-HDLB



47 x 4 x 1380 mm



1 4750-HDLB-1

Quick Release Fabric Adjustable Belts



4750-QRFB-1



50 x 4 x 1180 mm



1 4750-QRFB-1

Two Pocket Fixings Pouches



4750-2PP



285 x 130 x 265 mm



1 4750-2PP-1

Junior Three Pouch Belt Set



4750-JU3PB



125 x 55 x 395 mm



1 4750-JU3PB-1

Right and Left Handed Drill Holsters



4750-DHO-3



320 x 73 x 175 mm



1 4750-DHO-3



Electrician's Pouches



4750-EP



345 x 120 x 260 mm

1 4750-EP-1

Vertical Mobile Phone Holders



4750-VMPH-1



170 x 35 x 100 mm

1 4750-VMPH-1

Braces with Clips



4750-BWC-1



750 x 20 x 105 mm

1 4750-BWC-1

Multipurpose Holders



4750-MPH-1



240 x 50 x 155 mm

1 4750-MPH-1

Roll Covers for Tools



4750-ROCO-1



320 x 5 x 370 mm

1 4750-ROCO-1

Squeeze Knife Holders



4750-KNHO-1



205 x 35 x 105 mm

1 4750-KNHO-1

Flooring and Roofing Knee Pads



4750-KP



200 x 30 x 170 mm

1 4750-KP-1

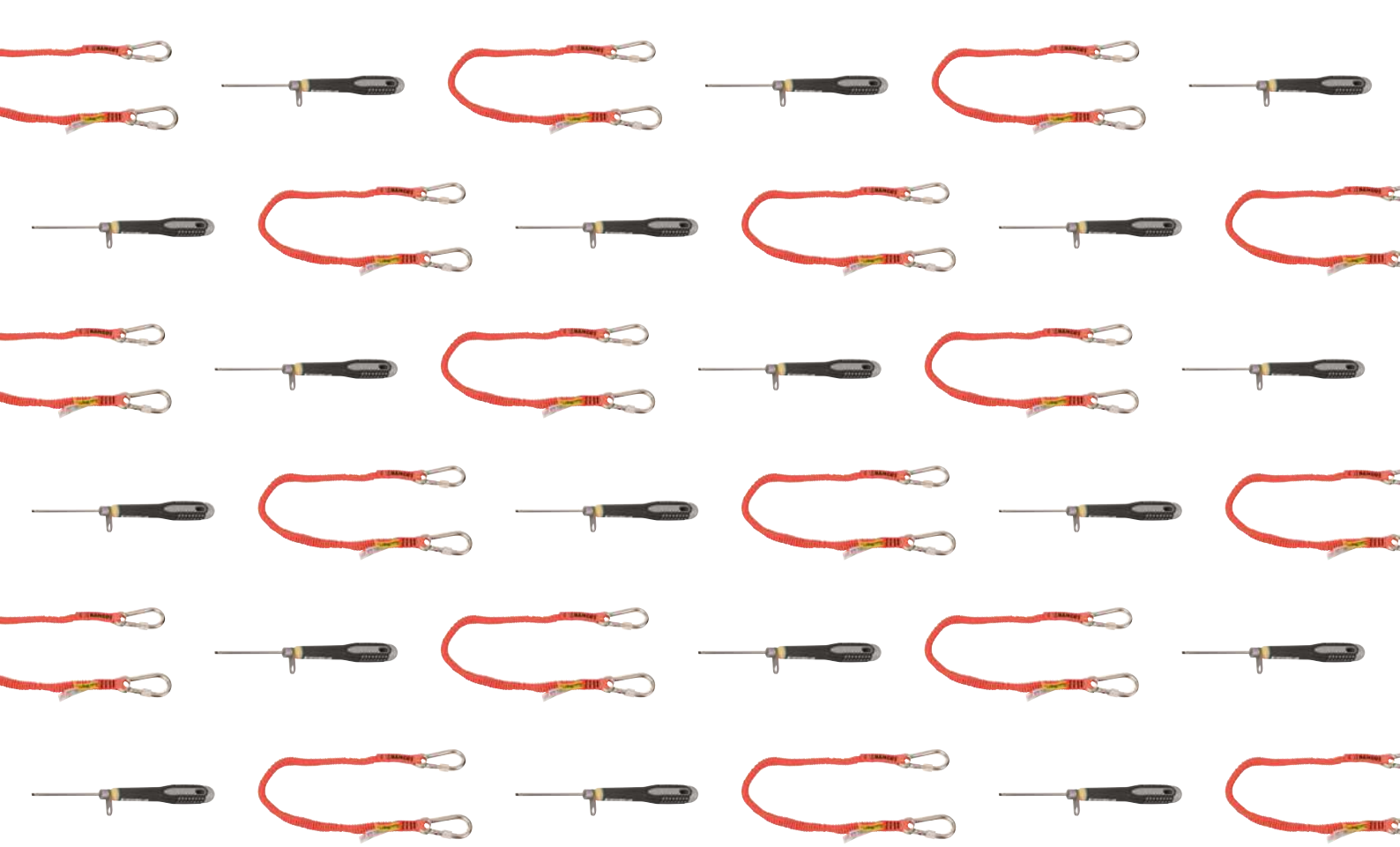

Tools @ Height



TOOL STORAGE & LANYARDS

High Visibility Orange Strap Lanyards with Swivel Carabiner 1 kg



3875-LY60



g



135 g

1 3875-LY600

Strap Lanyards with Fixed Carabiner and Interchangeable Loop 1 kg



3875-LY3

g



125 g

8 3875-LY3

Wrist Lanyards with Exchangeable Loop and Barrel Lock 1 kg



3875-WL1

g



40 g

8 3875-WL1

Connecting Loops for Lanyard



3875-QL1

g



40 g

8 3875-QL1

Retractable Lanyards with Fixed Carabiner 0.9 kg



3875-RL1

g



200 g

1 3875-RL1

Connecting Loops for Retractable Lanyard



3875-QRL1

g



40 g

1 3875-QRL1

Retractable Lanyards with Fixed Carabiner 1 kg



3875-RL2

g



212 g

1 3875-RL2

High Visibility Orange Strap Lanyards with Fixed Carabiner 3 kg



3875-LY70



g



172 g

1 3875-LY70

Strap Lanyards with Fixed Carabiner and Fixed Loop 3 kg



3875-LY2

g



120 g

8 3875-LY2

High Visibility Orange Strap Lanyards with Fixed Carabiner 6 kg



3875-LY8



g



330 g

1 3875-LY8*

High Visibility Orange Strap Lanyards with Fixed Carabiner 12 kg



3875-LY10



270 g



1 3875-LY10*

Steel String Lanyards



3875-SL1



10 g



1 3875-SL1

Bags for Working at Height



3875-HB10



260 x 130 x 130 mm



1 3875-HB10*

Coiled Lanyards with 1 mm Wire Loop String



439000000



100 g



1 439000000

Coiled Lanyards with Swivel Carabiner 3 kg



439000003



160 g



1 439000003*

Lifting Bags with Single Reinforced Lifting Straps



3875-HB30/3875-HB60



270 x 270 x 330 mm
340 x 340 x 620 mm



1 3875-HB30
6 3875-HB60

Coiled Lanyards with 1.5 mm Wire Loop String



439000001



130 g



1 439000001

High Visibility Orange Strap Lanyards with Plastic Clip



439000004



13 g



1 439000004*

Lifting Bags with Double Reinforced Lifting Straps



3875-HB100



390 x 390 x 890 mm



1 3875-HB100

* Until stocks last



Rigid Case Lifting Bags with Double Reinforced Lifting Straps



3875-SB70



790 x 300 x 750 mm

1 3875-SB70



Three Pouch Set Belts with 4 Safety Rings for Lanyard Attachment



3PB-2



80 x 270 x 1350 mm

1 4750-3PB-2

Hammer Holster Belt Pouches with 1 Safety Ring for Lanyard Attachment



4750-HHO-2



110 x 65 x 165 mm

1 4750-HHO-2

Backpacks with Durable Polyester Large Size



3875-BP2



240 x 340 x 440 mm

10 3875-BP2



Measuring Tape Pouches with 1 Safety Ring for Lanyard Attachment



4750-MTHO-TAH



80 x 110 x 165 mm

1 4750-MTHO-TAH

Heavy Duty Belts with 6 Safety Rings for Lanyard Attachment



4750-HDLB-TAH



50 x 120 x 1410 mm

1 4750-HDLB-TAH

Pouches with 2 Large Pockets and 6 Safety Rings for Lanyard Attachment



3875-MHP6



100 x 185 x 370 mm

1 3875-MHP6

Multipurpose Pouches with 2 Large Pockets and 4 Safety Rings for Lanyard Attachment



4750-UP-2



270 x 145 x 270 mm

1 4750-UP-2

WRENCHES

ERGO™ 90 Series Adjustable Wrenches with Quick Link



TAH90



158mm/6" 20 mm
250mm/10" 31 mm

1 TAH9070
1 TAH9072



80 Series Adjustable Wrenches with Quick Link



TAH80



Length	Width	Quantity	Model
110mm/4"	13 mm	1	TAH8069
155mm/6"	20 mm	1	TAH8070
205mm/8"	27 mm	1	TAH8071
255mm/10"	31 mm	1	TAH8072
305mm/12"	34 mm	1	TAH8073
380mm/15"	44 mm	1	TAH8074
460mm/18"	53 mm	1	TAH8075
110mm/4"	13 mm	1	TAH8069C*
155mm/6"	20 mm	1	TAH8070C*
205mm/8"	27 mm	1	TAH8071C*
255mm/10"	31 mm	1	TAH8072C*
305mm/12"	34 mm	1	TAH8073C*
380mm/15"	44 mm	1	TAH8074C*
460mm/18"	53 mm	1	TAH8075C*

Podger Wrenches with Safety D-Shackle



TAH84



Length	Width	Quantity	Model
405mm/16"	41 mm	1	TAH84-PODGER

Metric Combination Wrenches with Safety Spring



TAH111M



Size	Length	Quantity	Model
6 mm	112 mm	1	TAH111M-6
7 mm	120 mm	1	TAH111M-7
8 mm	130 mm	1	TAH111M-8
9 mm	136 mm	1	TAH111M-9
10 mm	144 mm	1	TAH111M-10
11 mm	153 mm	1	TAH111M-11
12 mm	160 mm	1	TAH111M-12
13 mm	165 mm	1	TAH111M-13

Size	Length	Quantity	Model
14 mm	177 mm	1	TAH111M-14
15 mm	185 mm	1	TAH111M-15
16 mm	195 mm	1	TAH111M-16
17 mm	200 mm	1	TAH111M-17
18 mm	208 mm	1	TAH111M-18
19 mm	215 mm	1	TAH111M-19
20 mm	240 mm	1	TAH111M-20
21 mm	250 mm	1	TAH111M-21
22 mm	250 mm	1	TAH111M-22
23 mm	270 mm	1	TAH111M-23
24 mm	270 mm	1	TAH111M-24
25 mm	290 mm	1	TAH111M-25
27 mm	310 mm	1	TAH111M-27
30 mm	330 mm	1	TAH111M-30
32 mm	345 mm	1	TAH111M-32
34 mm	347 mm	1	TAH111M-34
36 mm	400 mm	1	TAH111M-36
41 mm	438 mm	1	TAH111M-41
46 mm	500 mm	1	TAH111M-46
50 mm	540 mm	1	TAH111M-50
55 mm	560 mm	1	TAH111M-55

Imperial Combination Wrenches with Safety Spring



TAH111Z

Size	Length	Quantity	Model
5/16 in	130 mm	1	TAH111Z-5/16*
3/8 in	140 mm	1	TAH111Z-3/8*
1/2 in	169 mm	1	TAH111Z-1/2*
9/16 in	177 mm	1	TAH111Z-9/16*
5/8 in	195 mm	1	TAH111Z-5/8*
11/16 in	200 mm	1	TAH111Z-11/16*
13/16 in	250 mm	1	TAH111Z-13/16*
7/8 in	250 mm	1	TAH111Z-7/8*
15/16 in	270 mm	1	TAH111Z-15/16*
1 in	290 mm	1	TAH111Z-1*
1-1/16 in	310 mm	1	TAH111Z-1.1/16*
1-1/8 in	310 mm	1	TAH111Z-1.1/8*
1-1/4 in	350 mm	1	TAH111Z-1.1/4*
1-5/16 in	350 mm	1	TAH111Z-1.5/16*
1 3/8 in	410 mm	1	TAH111Z-1.3/8*
1 7/16 in	410 mm	1	TAH111Z-1.7/16*
1 1/2 in	410 mm	1	TAH111Z-1.1/2*
1 5/8 in	460 mm	1	TAH111Z-1.5/8*
1 11/16 in	460 mm	1	TAH111Z-1.11/16*
1 3/4 in	500 mm	1	TAH111Z-1.3/4*
1 13/16 in	500 mm	1	TAH111Z-1.13/16*
1 7/8 in	540 mm	1	TAH111Z-1.7/8*
2 in	540 mm	1	TAH111Z-2*
2 1/4 in	600 mm	1	TAH111Z-2.1/4*
2 3/8 in	600 mm	1	TAH111Z-2.3/8*
2 5/8 in	680 mm	1	TAH111Z-2.5/8*
2 3/4 in	680 mm	1	TAH111Z-2.3/4*
2 7/8 in	730 mm	1	TAH111Z-2.7/8*
3 in	730 mm	1	TAH111Z-3*

Ratcheting Combination Wrenches with Safety Spring



TAH1RM

Size	Length	Quantity	Model
6 mm	128 mm	1	TAH1RM-6
7 mm	140 mm	1	TAH1RM-7
8 mm	140 mm	1	TAH1RM-8
9 mm	150 mm	1	TAH1RM-9
10 mm	159 mm	1	TAH1RM-10
11 mm	165 mm	1	TAH1RM-11
12 mm	172 mm	1	TAH1RM-12
13 mm	178 mm	1	TAH1RM-13
14 mm	191 mm	1	TAH1RM-14
15 mm	200 mm	1	TAH1RM-15
16 mm	208 mm	1	TAH1RM-16
17 mm	226 mm	1	TAH1RM-17
18 mm	237 mm	1	TAH1RM-18
19 mm	248 mm	1	TAH1RM-19
21 mm	290 mm	1	TAH1RM-21
22 mm	361 mm	1	TAH1RM-22
24 mm	323 mm	1	TAH1RM-24
27 mm	359 mm	1	TAH1RM-27
30 mm	400 mm	1	TAH1RM-30
32 mm	425 mm	1	TAH1RM-32

Metric Deep Offset Double Ring End Spanners with Chrome Finish with Stainless Steel Sliding Spring



TAH2M

Size	Length	Quantity	Model
6x7 mm	165 mm	1	TAH2M-6-7*
8x9 mm	180 mm	1	TAH2M-8-9*
10x11 mm	190 mm	1	TAH2M-10-11*
12x13 mm	210 mm	1	TAH2M-12-13*
14x15 mm	226 mm	1	TAH2M-14-15*
16x17 mm	246 mm	1	TAH2M-16-17*
18x19 mm	266 mm	1	TAH2M-18-19*

* Until stocks last



Metric Double Open End Wrenches with Safety Spring



TAH6M



Size	Length (L)	Quantity	Part Number
6x7 mm	122 mm	1	TAH6M-6-7
8x9 mm	135 mm	1	TAH6M-8-9
10x11 mm	153 mm	1	TAH6M-10-11
12x13 mm	164 mm	1	TAH6M-12-13
14x15 mm	183 mm	1	TAH6M-14-15
16x17 mm	201 mm	1	TAH6M-16-17
17x19 mm	222 mm	1	TAH6M-17-19
18x19 mm	222 mm	1	TAH6M-18-19
20x22 mm	225 mm	1	TAH6M-20-22
24x27 mm	260 mm	1	TAH6M-24-27
30x32 mm	300 mm	1	TAH6M-30-32

Ring End Slogging Wrenches with D-Shackle



TAH7444SG



Size	Length (L)	Quantity	Part Number
36 mm	205 mm	1	TAH7444SG-M-36
41 mm	230 mm	1	TAH7444SG-M-41
46 mm	240 mm	1	TAH7444SG-M-46
50 mm	255 mm	1	TAH7444SG-M-50
55 mm	270 mm	1	TAH7444SG-M-55

Metric Double Head Offset Socket Spanners with 6 x 6-Point Dynamic Drive™ with Stainless Steel Ring



TAH29



Size	Length (L)	Quantity	Part Number
6 mm		1	TAH29M-6*
7 mm		1	TAH29M-7
8 mm		1	TAH29M-8
9 mm		1	TAH29M-9*
10 mm		1	TAH29M-10
11 mm		1	TAH29M-11*
12 mm		1	TAH29M-12*
13 mm		1	TAH29M-13
14 mm		1	TAH29M-14*
15 mm		1	TAH29M-15*
16 mm		1	TAH29M-16*
17 mm		1	TAH29M-17*
18 mm		1	TAH29M-18*
19 mm		1	TAH29M-19*
20 mm		1	TAH29M-20*
21 mm		1	TAH29M-21*
22 mm		1	TAH29M-22*
23 mm		1	TAH29M-23*
24 mm		1	TAH29M-24*
25 mm		1	TAH29M-25*
26 mm		1	TAH29M-26*
27 mm		1	TAH29M-27*
28 mm		1	TAH29M-28*
29 mm		1	TAH29M-29*
30 mm		1	TAH29M-30*
32 mm		1	TAH29M-32*

Flare Nut Wrenches with Safety Spring



TAH1949M



Size	Length (L)	Quantity	Part Number
8x9 mm	140 mm	1	TAH1949M-8-9*
10x11 mm	150 mm	1	TAH1949M-10-11*
12x14 mm	170 mm	1	TAH1949M-12-14*
14x17 mm	200 mm	1	TAH1949M-14-17*
19x22 mm	220 mm	1	TAH1949M-19-22*
24x27 mm	255 mm	1	TAH1949M-24-27*

Switch Cabinet Wrenches with Dyneema Ready to Work at Height



TAHMK5



Length (L)	Quantity	Part Number
97x25 mm	1	TAHMK5

Ratchet Wrenches with Safety Ring and Dee Shackle



TAHSC2RM



Size	Length (L)	Quantity	Part Number
13-17 mm	280 mm	1	TAHSC2RM-13-17
15-17 mm	280 mm	1	TAHSC2RM-15-17
19-22 mm	310 mm	1	TAHSC2RM-19-22
27-30 mm	450 mm	1	TAHSC2RM-27-30

PIPE WRENCHES

ERGO™ Swedish Model Pipe Wrenches with Wire Loop



TAH1410-TAH1420



Length (L)	Size	Quantity	Part Number
320 mm	1 in	1	TAH1410
430 mm	1 1/2 in	1	TAH1420

Swedish Model 90° Pipe Wrenches with Bow Shackle



TAH14



L	max		
210 mm	3/4 in	1	TAH140
320 mm	1 in	1	TAH141
426 mm	1 1/2 in	1	TAH142
557 mm	2-1/2 in	1	TAH143

Pipe Cutters 3mm-28mm with Stainless Steel Ring



TAH401-28



Ø		
3-28 mm	1	TAH401-28*

Plastic Wheel Reamer with Kevlar String



TAH317-40



Ø		
3-40	1	TAH317-40*

Aluminium Pipe Wrenches with Quick Link



TAH380



L	max		
253 mm	1.1/2 in	1	TAH380-10
354 mm	2 in	1	TAH380-14
455 mm	2.1/2 in	1	TAH380-18
607 mm	3 in	1	TAH380-24

Pipe Cutters 3mm-35mm with Stainless Steel Ring



TAH402-35



Ø		
3-35 mm	1	TAH402-35*

1/4" Square Drive Sockets with Metric Hex Profile and 4 point solution



TAH08



Ø		
5.5 mm	1	TAH08-5.5
6 mm	1	TAH08-6
7 mm	1	TAH08-7
8 mm	1	TAH08-8
9 mm	1	TAH08-9
10 mm	1	TAH08-10
11 mm	1	TAH08-11
12 mm	1	TAH08-12
13 mm	1	TAH08-13

Pipe Cutters 3mm-16mm with Stainless Steel Ring



TAH401-16



Ø		
3-16 mm	1	TAH401-16*

Tube Cutter with Stainless Steel Ring



TAH302-35



Ø		
3-35 mm	1	TAH302-35*

1/4" Square Drive Breaker Bars with Safety Spring



TAH6958B-1



L		
150 mm	1	TAH6958B-1

* Until stocks last



1/4" Square Drive Extension Bars with 4 Holes



TAH6960-TAH6962L

L	Part Number
50 mm	1 TAH6960
101 mm	1 TAH6961
152 mm	1 TAH6962
355 mm	1 TAH6962L

1/4" Square Drive Socket Drivers for Phillips Head Screws with 4 Points Solution



TAH08-PH

Length	Part Number
1	1 TAH08-PH1
2	1 TAH08-PH2
3	1 TAH08-PH3

1/4" Square Drive Spinner Handles with Safety Chuck



TAH6956-1

L	Part Number
150 mm	1 TAH6956-1

1/4" Square Drive Universal Joints with 4 Holes



TAH6966

L	Part Number
36 mm	1 TAH6966

1/4" Square Drive Socket Drivers for TORX® Head Screws with 4 Points Solution



TAH08TTAH

Length	Part Number
T-8	1 TAH08-T8
T-9	1 TAH08-T9
T-10	1 TAH08-T10
T-15	1 TAH08-T15
T-20	1 TAH08-T20
T-25	1 TAH08-T25
T-27	1 TAH08-T27
T-30	1 TAH08-T30
T-40	1 TAH08-T40

1/2" Square Drive Sockets with Metric Bi-Hex Profile and 4 Point Solution



TAH16B

Length	Part Number
8 mm	1 TAH16B-8*
10 mm	1 TAH16B-10
11 mm	1 TAH16B-11
12 mm	1 TAH16B-12
13 mm	1 TAH16B-13
14 mm	1 TAH16B-14
15 mm	1 TAH16B-15
16 mm	1 TAH16B-16
17 mm	1 TAH16B-17
18 mm	1 TAH16B-18
19 mm	1 TAH16B-19
21 mm	1 TAH16B-21
22 mm	1 TAH16B-22
24 mm	1 TAH16B-24
25 mm	1 TAH16B-25
27 mm	1 TAH16B-27
30 mm	1 TAH16B-30
32 mm	1 TAH16B-32

1/4" Square Drive Socket Drivers for Metric Hex Head Screws with 4 Points Solution



TAH08-H

Length	Part Number
3 mm	1 TAH08-H3
4 mm	1 TAH08-H4
5 mm	1 TAH08-H5
6 mm	1 TAH08-H6
8 mm	1 TAH08-H8

1/4" Square Drive Reversible Ratchets with Sealed Dyneema String



TAH6950

L	Part Number
120 mm	1 TAH6950

1/2" Square Drive Sockets with Imperial Bi-Hex Profile and 4 Point Solution



TAH16B"



1/2 in	1	TAH16B-1/2
9/16 in	1	TAH16B-9/16
5/8 in	1	TAH16B-5/8
11/16 in	1	TAH16B-11/16
3/4 in	1	TAH16B-3/4
13/16 in	1	TAH16B-13/16
7/8 in	1	TAH16B-7/8*
15/16 in	1	TAH16B-15/16*
1 in	1	TAH16B-1
1 1/16 in	1	TAH16B-1.1/16
1 1/8 in	1	TAH16B-1.1/8
1 1/4 in	1	TAH16B-1.1/4

1/2" Universal Joints with 4 Point Solution



TAH8166



67 mm	1	TAH8166
-------	---	---------

1/2" Square Drive Socket Drivers for Metric Hex Head Screws with 4 point solution



TAH16H



4 mm	1	TAH16-H4
5 mm	1	TAH16-H5
6 mm	1	TAH16-H6
7 mm	1	TAH16-H7
8 mm	1	TAH16-H8
10 mm	1	TAH16-H10
12 mm	1	TAH16-H12
14 mm	1	TAH16-H14
17 mm	1	TAH16-H17
19 mm	1	TAH16-H19

1/2" Breaker Bars with Safety Spring



TAH8158B-1



256 mm	1	TAH8158B-1
--------	---	------------

1/2" Extension Bars with 4 Holes



TAH8160-8162



125 mm	1	TAH8160
250 mm	1	TAH8162

1/2" Square Drive Socket Drivers for Imperial Hex Head Screws with 4 point solution



TAH16H"



1/4 in	1	TAH16H-1/4
5/16 in	1	TAH16H-5/16
3/8 in	1	TAH16H-3/8



7/16 in	1	TAH16H-7/16
1/2 in	1	TAH16H-1/2
9/16 in	1	TAH16H-9/16
5/8 in	1	TAH16H-5/8

1/2" Square Drive Socket Drivers for TORX® Head Screws with 4 Points Solution



TAH16-T



T30	1	TAH16-T30
T40	1	TAH16-T40
T45	1	TAH16-T45*
T50	1	TAH16-T50
T55	1	TAH16-T55
T60	1	TAH16-T60

1/2" Square Drive Socket Drivers for Metric Hex Head Screw with 4 Points Solution



TAH7809M



10 mm	23 mm	1	TAH7809M-10-140*
8 mm	23 mm	1	TAH7809M-8-120*

* Until stocks last



1/2" Square Drive Socket Drivers for Multipoint Head Screw with 4 Point Solution



TAH7809XZN



10	1	TAH7809XZN-10
12	1	TAH7809XZN-12
14	1	TAH7809XZN-14
16	1	TAH7809XZN-16
18	1	TAH7809XZN-18
6	1	TAH7809XZN-6
8	1	TAH7809XZN-8

1/2" Reversible Ratchets with Sealed Dyneema String



TAH8150-1/2



270 mm	1	TAH8150-1/2
--------	---	-------------

1/2" Square Drive Socket Set with Metric Hex Profile and Pear Head Ratchet - 22 pcs for Working at Height



TAH16BM/22



85 x 350 x 445 mm	1	TAH16BM/22
-------------------	---	------------

1/2" Square Drive Socket Set with Imperial Hex Profile and Pear Head Ratchet - 17 pcs for Working at Height



TAH16BZ/17

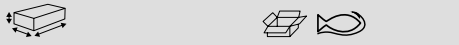

80 x 300 x 380 mm	1	TAH16BZ/17*
-------------------	---	-------------

3/4" Square Drive Sockets with Metric Hex Profile and 4 point solution



TAH24B

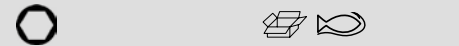

27 mm	1	TAH24B-27
30 mm	1	TAH24B-30
32 mm	1	TAH24B-32
36 mm	1	TAH24B-36
38 mm	1	TAH24B-38
41 mm	1	TAH24B-41
46 mm	1	TAH24B-46
50 mm	1	TAH24B-50

3/4" Square Drive Extension Bars with 4 Point Solution



TAH8961

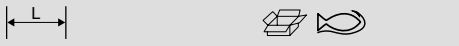

200 mm	1	TAH8961
--------	---	---------

3/4" Square Drive Universal Handles with Loop Wire



TAH8953

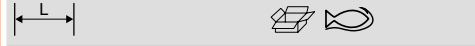

500 mm	1	TAH8953*
--------	---	----------

3/4" Square Drive Reversible Ratchet Heads with Loop Wire



TAH8950N/A

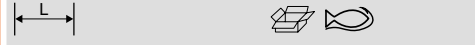

170 mm	1	TAH8950N/A*
--------	---	-------------

Stubby Pin Releasers for TAH Sockets



TAHPINRELEASER

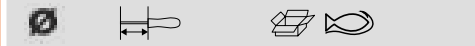

4 mm	45 mm	1	TAHPINRELEASER
------	-------	---	----------------

SCREWDRIVERS

ERGO™ Slotted Screwdrivers with Safety Chuck



ergo



TAHBE8020L-TAHBE8252



3.2 mm	75 mm	1	TAHBE-8020L
3.5 mm	75 mm	1	TAHBE-8030
4 mm	100 mm	1	TAHBE-8040
5.5 mm	150 mm	1	TAHBE-8241
6.5 mm	150 mm	1	TAHBE-8252

ERGO™ Slotted Screwdrivers with Dyneema String



ergo



TAHBE8155



6 mm	125 mm	1	TAHBE-8155
8 mm	175 mm	1	TAHBE-8257
10 mm	210 mm	1	TAHBE-8258

ERGO™ Bolster Screwdrivers for Slotted Head Screws with Dyneema String



ergo



TAHBE-8260



9 mm	175 mm	1	TAHBE-8260
12 mm	200 mm	1	TAHBE-8880

ERGO™ Stubby Screwdrivers for Slotted Head Screws with Safety Chuck



ergo



TAHBE-8350

5.5 mm	28 mm	1	TAHBE-8350

ERGO™ Screwdrivers for Phillips Head Screws with Safety Chuck



ergo



TAHBE8610-TAHBE8624

PH 1	75 mm	1	TAHBE-8611
PH 1	75 mm	1	TAHBE-8610
PH 2	100 mm	1	TAHBE-8620
PH 2	200 mm	1	TAHBE-8620L
PH 3	150 mm	1	TAHBE-8623
PH 4	190 mm	1	TAHBE-8624

ERGO™ Bolster Screwdrivers for Phillips Head Screws with Dyneema String



ergo



TAHBE-8630

PH 3	155 mm	1	TAHBE-8630

ERGO™ Stubby Screwdrivers for Phillips Head Screws with Safety Chuck



ergo



TAHBE-8602

PH2	30 mm	1	TAHBE-8602

ERGO™ Screwdrivers for Pozidriv Head Screws with Safety Chuck



ergo



TAHBE8810-TAHBE8820

PZ 1	73 mm	1	TAHBE-8810
PZ 2	100 mm	1	TAHBE-8820

ERGO™ Bolster Screwdrivers for Pozidriv Head Screws with Dyneema String



ergo



TAHBE-8830

PZ 3	150 mm	1	TAHBE-8830



ERGO™ Screwdrivers for TORX® Head Screws with Safety Chuck



TAHBE8910-TAHBE8930



Head	Length	Part No.
T10	2.72 mm	1 TAHBE-8910
T15	3.26 mm	1 TAHBE-8915
T20	3.84 mm	1 TAHBE-8920
T25	4 mm	1 TAHBE-8925
T30	6 mm	1 TAHBE-8930

ERGO™ Insulated TORX® Head Screwdrivers with Kevlar String



TAHBE8910S-TAHBE8930S



Head	Length	Part No.
T10	2.5 mm	1 TAHBE-8910S
T15	3.26 mm	1 TAHBE-8915S
T20	3.84 mm	1 TAHBE-8920S
T25	4.4 mm	1 TAHBE-8925S
T30	5.49 mm	1 TAHBE-8930S

Phillips Screwdrivers with Precision Grip PH00-PH1 with Stainless Steel Ring



TAH701

Head	Length	Part No.
PH00	137 mm	1 TAH701-00-50
PH 0	137 mm	1 TAH701-0-50

ERGO™ Insulated Slotted Screwdrivers with Kevlar String



TAHBE8040S-TAHBE8050S



Head	Length	Part No.
3.0 mm	100 mm	1 TAHBE-8220S
4.0 mm	100 mm	1 TAHBE-8040S
5.5 mm	125 mm	1 TAHBE-8050S
6.5 mm	155 mm	1 TAHBE-8255S

ERGO™ Slim VDE Insulated Pozidriv Screwdrivers with 3-Component Handle with Kevlar Cord



TAHBE-8820SL



Head	Length	Part No.
PZ 2	PZ 2	1 TAHBE-8820SL

Torx® Screwdrivers with Precision Grip T4-T20 with Stainless Steel Ring



TAH703

Head	Length	Part No.
T 6	137 mm	1 TAH703-6-50
T 7	137 mm	1 TAH703-7-50
T 8	137 mm	1 TAH703-8-50
T 9	137 mm	1 TAH703-9-50
T 10	137 mm	1 TAH703-10-50
T 15	162 mm	1 TAH703-15-75

ERGO™ Insulated Phillips Screwdrivers with Kevlar String



TAHBE8610S-TAHBE8620S



Head	Length	Part No.
PH1	80 mm	1 TAHBE-8610S
PH2	100 mm	1 TAHBE-8620S
PH3	150 mm	1 TAHBE-8630S
PH4	190 mm	1 TAHBE-8640S

Slotted Screwdrivers with Precision Grip 0.18-0.8 mm with Stainless Steel Ring



TAH700

Head	Length	Part No.
1.5 mm	137 mm	1 TAH700-1.5-50
1.8 mm	137 mm	1 TAH700-1.8-50
2.5 mm	137 mm	1 TAH700-2.5-50
3 mm	187 mm	1 TAH700-3-100

Hex Screwdrivers with T-Handle Grip with Dyneema String



TAH900T

Head	Length	Part No.
2	100 mm	1 TAH900T-020-100
2.5	100 mm	1 TAH900T-025-100
3 mm	100 mm	1 TAH900T-030-100
4	138 mm	1 TAH900T-040-150
5 mm	138 mm	1 TAH900T-050-150
6 mm	185 mm	1 TAH900T-060-200
8 mm	185 mm	1 TAH900T-080-200
10 mm	185 mm	1 TAH900T-100-200

TORX® Screwdriver with T-Handle Grip with Dyneema String



TAH901T

T 6	100 mm	1	TAH901T-006-100
T 7	100 mm	1	TAH901T-007-100
T 8	100 mm	1	TAH901T-008-100
T 9	100 mm	1	TAH901T-009-100
T 10	100 mm	1	TAH901T-010-100
T 15	138 mm	1	TAH901T-015-150
T 20	138 mm	1	TAH901T-020-150
T 25	138 mm	1	TAH901T-025-150
T 27	138 mm	1	TAH901T-027-150
T 30	185 mm	1	TAH901T-030-200
T 40	185 mm	1	TAH901T-040-200
T 45	185 mm	1	TAH901T-045-200
T 50	185 mm	1	TAH901T-050-200

Metric Hex Folding L-Key Set with Phosphate Finish 1.5-6 mm - 7 pcs with Kevlar Textile Wire Loop



TAHBE-9776

7	1.5 2 2.5 3 4 5 6 mm	1	TAHBE-9776

Double Offset Keys for Slotted Screws with Steel Wire



TAH2047

4.0 mm	100 mm	1	TAH2047-0.8-4

Metric Hex L-Keys with Phosphate Finish with Stainless Steel Ring



TAH1995M

8 mm	108 mm	1	TAH1995M-8*
10 mm	122 mm	1	TAH1995M-10*
12 mm	137 mm	1	TAH1995M-12*

Metric Offset Screwdriver Hex Key Folders with Kevlar String - 7 Pcs



TAHBE-9777B

2,5,3,4,5,6,8,10 mm		1	TAHBE-9777B

Double Offset Keys for Phillips Screws with Steel Wire



TAH2047PR

PH 1 & 2	100 mm	1	TAH2047PR-1-2

Imperial Hex L-Keys with Phosphate Finish with Stainless Steel Ring



TAH1995Z

1/2 in	145 mm	1	TAH1995Z-1/2*

Imperial Offset Screwdriver Hex Key Folders with Insert Plate - 7 Pcs



TAHBE-9787

3/32, 1/8, 5/32, 3/16, 1/4, 5/16, 3/8 in		1	TAHBE-9787

PLIERS

ERGO™ Side Cutting Pliers with Safety Ring



ergo



TAH2101G

130 mm		1	TAH2101G-125
145 mm		1	TAH2101G-140
165 mm		1	TAH2101G-160
185 mm		1	TAH2101G-180
125 mm		1	TAH2101G-125C*
145 mm		1	TAH2101G-140C*
165 mm		1	TAH2101G-160C*
180 mm		1	TAH2101G-180C*

* Until stocks last



ERGO™ Heavy Duty Side Cutting Pliers with Safety Ring



ergo



TAH21HDG



210 mm	1 TAH21HDG-200
200 mm	1 TAH21HDG-200C

ERGO™ Snipe Nose Pliers with Safety Ring



ergo



TAH2430G



160 mm	1 TAH2430G-160
200 mm	1 TAH2430G-200

Ratcheting Crimping Pliers for Insulated Connectors with Fixed Metallic Wire Loop



TAHCRW01



225 mm	0.5-6.0 mm ²	1 TAHCRW01
--------	-------------------------	------------

ERGO™ Combination Pliers with Safety Ring



ergo



TAH2628G



170 mm	1 TAH2628G-160
190 mm	1 TAH2628G-180
200 mm	1 TAH2628G-200*

ERGO™ Snipe Nose Pliers with 45° Bent Tips and Safety Ring



ergo



TAH2427G



200 mm	1 TAH2427G-200
--------	----------------

Internal Circlip Pliers with Straight Jaws and Phosphate Finish with Stainless Steel Ring



TAH2800



150 mm	1 TAH2800-150
180 mm	1 TAH2800-180

2 Position Combination Pliers with Safety Ring



ergo



TAH2970G



200 mm	1 TAH2970G-200*
--------	-----------------

ERGO™ Wire Stripping Pliers with Safety Ring



TAH2223G-150



167 mm	1 TAH2223G-150
--------	----------------

External Circlip Pliers with Straight Jaws and Phosphate Finish with Stainless Steel Ring



TAH2900



180 mm	1 TAH2900-180
--------	---------------

Grip Locking Pliers with Curved Jaws with Fixed Metallic Plate



TAH2951



235 mm

1 TAH2951-250

Self Grip Locking Pliers with Curved Jaws with Fixed Metallic Plate



TAH2953



140 mm
300 mm

1 TAH2953-140
1 TAH2953-300

Grips with Straight Jaws and Insert Plate



TAH2958



200 mm
245 mm

1 TAH2958-200
1 TAH2958-250

ERGO™ Water Pump Pliers with Safety Ring



ergo



TAH8224



250 mm

1 TAH8224

High Leverage Fencing Pliers with Black Epoxy Finish and Safety Ring



TAH2339



2.5 mm

250 mm

1 TAH2339-250

CUTTING TOOLS

Folding Pruning Saws with Dual-Component Handle with Sealed Dyneema Cord



TAH396



190 mm

7 1/2 in

1 TAH396-JT

ERGO™ Professional Hand Hacksaw Frames with Loop Wire



ergo



TAH325



300 mm

1 TAH325

Traditional Hand Hacksaw Frames with Loop Wire



TAH320



500 mm

1 TAH320

Wire Twisting Pliers with Safety Ring



TAH2855



232 mm

1 TAH2855



Hacksaw Frames with Loop Wire for All Round Use



TAH317



432 mm 1 TAH317

Aluminium Hand Hacksaw Frames with Loop Wire



TAH225



310 mm 1 TAH225-PLUS

Mini Hacksaws with Sandflex® Bi-Metal Blade with Kevlar String



TAH208



330 mm 1 TAH208*

ERGO™ Flat Files with Safety Ring



ergo



TAH1-100

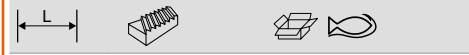

265 mm 2 1 TAH1-100-06-2-4

ERGO™ Engineering 3 Square Files Bastard/Second/Smooth Cut with Permanent Stainless Steel Ring



ergo



TAH1-170



200 mm 1 1 TAH1-170-08-1-2*

ERGO™ Engineering Tapered Edge Flat Files Bastard/Second/Smooth Cut with Permanent Stainless Steel Ring



ergo



TAH1-110

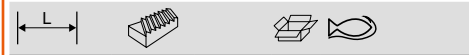

200 mm 1 1 TAH1-110-08-1-2*

ERGO™ Half-Round Files with Safety Ring



ergo



TAH1-210



270 mm 2 1 TAH1-210-06-2-2
325 mm 1 1 TAH1-210-08-1-2*

ERGO™ Mill Files with 2 Flat Edges and Safety Ring



ergo



TAH1-143



415 mm 1 1 TAH1-143-12-1-2

ERGO™ Round Files with Safety Chuck



ergo



TAH1-230



260 mm 2 1 TAH1-230-06-2-2
310 mm 1 1 TAH1-230-08-1-2*

ERGO™ Engineering Square Files Bastard/Second/Smooth Cut with Permanent Stainless Steel Ring



ergo



TAH1-160

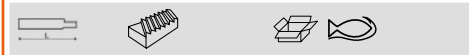

200 mm 1 1 TAH1-160-08-1-2*

Straight Cut Aviation Shears with Increased Power by Lever Action and Yellow Colour Coded Handle up to 1.5 mm with Safety Ring



TAHMA421



250 mm 1 TAHMA421*

Heavy Duty Electrician Scissors with Wire Loop



TAHSCB140G



145 mm	43 mm	1	TAHSCB140G

Utility Wire Brushes With Wooden Handle



TAH52-TAH782-U



150 mm 290 mm	1	TAH52 TAH782-U

Nylon Tip Mallets with Wire Loop



TAH3625PW



300 mm	1	TAH3625W-35

Electrician Knives with Dyneema String



TAH2820EF



195 mm	85 mm	1	TAH2820EF2

HAMMERS, PRY BARS & CHISELS

ERGO™ Straight Claw Hammers with Bi-Material Rubber Grip and Wire Loop



TAH529S



570 g	1	TAH529S-20-XL*

Nylon Tip Mallets with Rubber Grip with Wire Loop



TAH3625S



374 g	1	TAH3625S-28*

18-in-1 Aluminium Foldable Multitools with Wire Loop



TAHMTT151



150 mm	1	TAHMTT151

Dead Blow Sledge Hammers with Wire Loop and Anti-Sliding Handle



TAH3625PU



620 g	340 mm	1	TAH3625PU-50

Ball Pein Hammers with Wire Loop and Hickory Handle



TAH479



480 g 900 g	350 mm 400 mm	1	TAH479-16 TAH479-32

* Until stocks last



German DIN Hammers with Wire Loop



TAH481



300 g	300 mm	1	TAH481-300

Ball Pein Hammers with Unbreakable Handle and Fixed Metallic Wire Loop



TAH490



1100 g	340 mm	1	TAH490-1100*

Non-Sparking and Anti-Magnetic Hammers with Aluminium Bronze Shackle



TAH487



1000 g	110 mm	1	TAHNS502-1000-FB
4500 g	895 mm	1	TAH487-5200

Club Hammers with Wire Loop and Hickory Handle



TAH484



1000 g	260 mm	1	TAH484-1000
1500 g	280 mm	1	TAH484-1500
2000 g	305 mm	1	TAH484-2000

Spanish Type Bricklayer Hammers with Wire Loop



TAH486F



700 g	330 mm	1	TAH486F-700

Steel Hexagonal Bar with Fixed Metallic Wire Loop



TAHWBB



391 mm	1	TAHWBB400
595 mm	1	TAHWBB600
680 mm	1	TAHWBB700

Safety Sledge Hammers with Wire Loop



TAH489



1100 g	294 mm	1	TAH489-1100
1800 g	300 mm	1	TAH489-1800
2700 g	770 mm	1	TAH489-2700
3600 g	770 mm	1	TAH489-3600
4500 g	797 mm	1	TAH489-4500
5400 g	795 mm	1	TAH489-5400

Carpenter's Hammer Spike Claw with Tubular Steel Shaft with Wire Loop



TAH485



600 g	318 mm	1	TAH485

Bi-Material Parallel Punches with Safety Chuck



TAH3734BM



155 mm	2 mm	1	TAH3734BM-2
155 mm	3 mm	1	TAH3734BM-3
165 mm	4 mm	1	TAH3734BM-4
165 mm	5 mm	1	TAH3734BM-5
185 mm	6 mm	1	TAH3734BM-6
185 mm	8 mm	1	TAH3734BM-8
185 mm	10 mm	1	TAH3734BM-10

Bi-Material Centre Punches with Safety Chuck



TAH3755BM

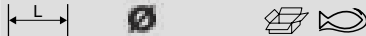

165 mm 4 mm 1 TAH3755BM-4

Pry Bars with PVC Handle and Safety Ring



TAH2484

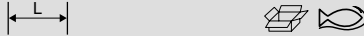

305 mm 1 TAH2484-30

MEASURING & LAYOUT

Long Measuring Tapes with Nylon Coated Blade and Open Case with Dyneema Textile Wire Loop



TAHLTS

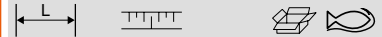

30 m 13 mm 1 TAHLTS-30*

Cold Chisels with Safety Ring



TAH3640



250 mm 1 TAH3640-250-C

Cam Pry Bars with Bow Shackle



TAH3683

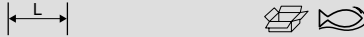

400 mm 1 TAH3683

Metric Stainless Steel Rulers with Dyneema Textile Wire Loop



TAHSR300

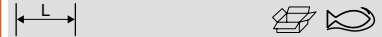

300 mm 1 TAHSR300-MM

Pointed Chisels with Octagonal Shank and Lacquered Copper Finish with Fixed Metallic Wire Loop



TAH3739

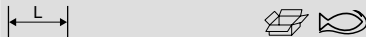

300 mm 1 TAH3739-300*

Rolling Head Pry Bars with Phosphated Body with Fixed Metallic Wire Loop



TAH3681

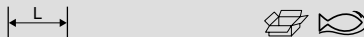

304 mm 1 TAH3681-11
406 mm 1 TAH3681-16
503 mm 1 TAH3681-20*

Scaffold Levels with Dyneema String



TAH466

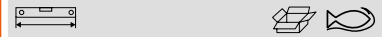

250 mm 1 TAH466-250

* Until stocks last



Combination Squares with Dyneema String



TAHC300

300 mm	125 mm	1	TAHC300*

Callipers with Safety Ring



TAH1150

7 x 75 x 235 mm	1	TAH1150-1/2H/P	

Carpenter Squares with Dyneema String



TAH9048-250

250 mm	165 mm	1	TAH9048-250*

Offset Scribes with Wire Loop



TAH1177

30 g	1	TAH1177-SCRIBE	

Squares with Dyneema String



TAH9045-B-250

250 mm	170 mm	1	TAH9045-B-250

Professional Feeler Gauges with Safety Ring



TAH1544

105 mm	1	TAH1544	

TORQUE TOOLS

Mechanical Adjustable Torque Click Wrench with Marked Scale & Interchangeable Head and Wire Loop



TAH7465-15

9x12 mm	3-15 N·m	1	TAH7465-15*

Mechanical Adjustable Torque Click Wrench with Marked Scale and Fixed Ratchet Head with Metallic Plate



TAH73R

1/2"	20-100 N·m	1	TAH73R-100
1/2"	40-200 N·m	1	TAH73R-200
1/2"	60-300 N·m	1	TAH73R-300

Torque Wrenches with Interchangeable Head and Wire Loop



TAH74W9

20-100 N·m	9x12 mm	1	TAH74W9-100

Reversible Ratchet Head Inserts with Locking Device



TAH7452-2



9x12 mm	1/2"	1	TAH7452-2*

CLAMPING TOOLS

F-Clamps with Safety Bow Shackle



TAH420SH-80-160



160 mm	80 mm	1	TAH420SH-80-160*

Flexible Pick-up Tools with Wire Loop



TAH2509



560 mm	1	TAH2509

Reversible Ratchet Insert Tools with Safety Pin Locking Mechanism



TAH7852-1



14X18 mm	1/2"	1	TAH7852-1*

OTHER TOOLS

Carbon Scrapers with Safety Spring



TAH2487



205 mm	1	TAH2487

ERGO™ Magnetic Pick-ups with Dyneema String



ergo™



TAH2535F2



13 mm	405 mm	1	TAH2535F2

Mechanical Adjustable Breaking Torque Wrench with Fixed Ratchet Head and Safety Eye-Bolt



TAH74R



3/4"	700-1500 N·m	1	TAH74R-1500

Miniature Awls/Hooks/Picks Tool Set with Kevlar Textile Wire Loop



TAH2633



146 g	1	TAH2633/S4

Chain Oil Filter Wrenches with D-shackle



TAHBE64520



520 mm	60-160 mm	1	TAHBE64520

* Until stocks last



Head Torches with Dyneema String



TAHBFRL11



90 x 95 x 115 mm

1 TAHBFRL11

GLOVES

General Purpose Gloves with Absorption Pad



GL008



8

5 GL008-8

10

5 GL008-10

Grease Pumps with Quick Link



TAHBOD54



120 x 385 x 57 mm
135 x 400 x 61 mm

1 TAHBOD5400
1 TAHBOD5450

Power Tool Gloves with Absorption Pad and Anti-Vibration Pad



GL010



8

5 GL010-8

10

5 GL010-10



Insulated Tools



SCREWDRIVERS

ERGO™ VDE Insulated Slotted Screwdrivers with 3-Component Handle 2.5 mm-12 mm



ergo



BE-8010S - BE-8065S

Tip	Length	Quantity	Model
2.5 mm	75 mm	5	BE-8010S
3.0 mm	100 mm	5	BE-8220S
3.5 mm	100 mm	5	BE-8230S
4.0 mm	100 mm	5	BE-8040S
5.5 mm	125 mm	5	BE-8050S
6.5 mm	150 mm	5	BE-8255S
8.0 mm	175 mm	5	BE-8065S
10 mm	200 mm	5	BE-8258S
12 mm	200 mm	5	BE-8259S

ERGO™ VDE Insulated Phillips Screwdrivers with 3-Component Handle PH0-PH4



ergo



BE-8600S - BE-8640S

Tip	Length	Quantity	Model
PH 0	75 mm	5	BE-8600S
PH 1	80 mm	5	BE-8610S
PH1	80 mm	5	BE-8611S
PH 1	150 mm	5	BE-8612S
PH 2	100 mm	5	BE-8620S
PH 2	100 mm	5	BE-8621S
PH 2	175 mm	5	BE-8622S
PH 3	150 mm	5	BE-8630S
PH 4	200 mm	5	BE-8640S

ERGO™ VDE Insulated Pozidriv Screwdrivers with 3-Component Handle PZ0-PZ4



ergo



BE-8800S - BE-8840S

Tip	Length	Quantity	Model
PZ 0	75 mm	5	BE-8800S
PZ 1	80 mm	5	BE-8810S
PZ1	80 mm	5	BE-8811S
PZ 1	150 mm	5	BE-8812S
PZ 2	100 mm	5	BE-8820S
PZ 2	100 mm	5	BE-8821S
PZ 2	175 mm	5	BE-8822S
PZ 3	150 mm	5	BE-8830S
PZ 4	200 mm	5	BE-8840S

ERGO™ VDE Insulated TORX® Head Screwdrivers with 3-Component Handle T5-T30



ergo



BE-8910S - BE-8930S

Tip	Length	Quantity	Model
T 5	75 mm	5	BE-8905S
T 6	75 mm	5	BE-8906S
T 7	75 mm	5	BE-8907S
T 8	75 mm	5	BE-8908S
T9	75 mm	5	BE-8909S
T 10	100 mm	5	BE-8910S
T 15	125 mm	5	BE-8915S
T 20	125 mm	5	BE-8920S
T 25	150 mm	5	BE-8925S
T 30	175 mm	5	BE-8930S

ERGO™ VDE Insulated Hex Socket-Head Screwdrivers with 3-Component Handle 2.5 mm-8 mm



ergo



BE-8725S - BE-8708S

Tip	Length	Quantity	Model
2.5 mm	100 mm	5	BE-8725S
3 mm	125 mm	5	BE-8703S
4 mm	150 mm	5	BE-8704S
5 mm	175 mm	5	BE-8705S
6 mm	150 mm	5	BE-8706S
8 mm	200 mm	5	BE-8708S

ERGO™ VDE Insulated Plus-Minus/Phillips-Tip Screwdrivers with 3-Component Handle 5.0/PH1-6.0/PH2



ergo



BE-8510S - BE-8520S

Tip	Length	Quantity	Model
5.0/PH1	80 mm	5	BE-8510S
6.0/PH2	100 mm	5	BE-8520S

ERGO™ VDE Insulated Plus-Minus/Pozidriv-Tip Screwdrivers with 3-Component Handle 5.0/PH1-6.0/PZ2



ergo



BE-8710S - BE-8720S

Tip	Length	Quantity	Model
5.0/PZ1	80 mm	5	BE-8710S
6.0/PZ2	100 mm	5	BE-8720S

ERGO™ VDE Insulated Nut Drivers with 3-Component Handle 5.5 mm-10 mm



ergo



BE-7855S - BE-7810S

Tip	Length	Quantity	Model
5.5 mm	125 mm	5	BE-7855S
6 mm	125 mm	5	BE-7806S
7 mm	125 mm	5	BE-7807S
8 mm	125 mm	5	BE-7808S
9 mm	125 mm	5	BE-7809S
10 mm	125 mm	5	BE-7810S

ERGO™ VDE Insulated Plus-Minus/
Pozidriv-Tip Screwdriver Set with
3-Component Handle - 2 Pcs



ergo



BE-9890S



2 175 g 1 BE-9890S

BE-8710S, BE-8720S



ERGO™ VDE Insulated Slotted and
Phillips Screwdriver Set with 3-Component
Handle - 5 Pcs



ergo



BE-9881S



5 1 BE-9881S

BE-8220S, BE-8040S, BE-8050S



BE-8611S, BE-8621S



ERGO™ VDE Insulated Slotted
and Pozidriv Screwdriver Set with
3-Component Handle - 5 Pcs



ergo



BE-9882S



5 1 BE-9882S

BE-8220S, BE-8050S, BE-8040S



BE-8811S, BE-8821S



ERGO™ VDE Insulated Plus-Minus/
Phillips, Plus-Minus/Pozidriv-Tip
Screwdriver Set with 3-Component Handle
and 150 V-250 V voltage tester - 5 Pcs



ergo



BE-9885S



5 1 BE-9885S

806-1-1



BE-8520S, BE-8510S



BE-8710S, BE-8720S



ERGO™ VDE Insulated Slotted, Pozidriv
and Plus-Minus/Pozidriv-Tip Screwdriver
Set with 3-Component Handle - 6 Pcs



ergo



BE-9884S



6 1 BE-9884S

BE-8220S, BE-8040S



BE-8710S, BE-8720S



BE-8810S, BE-8820S



ERGO™ VDE Insulated Slotted
and Pozidriv Screwdriver Set with
3-Component Handle - 7 Pcs



ergo



BE-9888S



7 1 BE-9888S

BE-8040S, BE-8050S, BE-8010S,
BE-8220S



BE-8800S, BE-8821S, BE-8830S



ERGO™ VDE Insulated Slotted and
Phillips Screwdriver Set with 3-Component
Handle - 7 Pcs



ergo



BE-9887S



7 1 BE-9887S

806-1-1



BE-8010S, BE-8050S, BE-8230S,
BE-8040S



BE-8611S, BE-8621S



ERGO™ VDE Insulated Slotted
and Pozidriv Screwdriver Set with
3-Component Handle - 7 Pcs



ergo



BE-9889S



7 1 BE-9889S

BE-8010S, BE-8040S, BE-8050S,
BE-8230S



BE-8821S, BE-8811S



806-1-1



ERGO™ Slotted, Phillips, Pozidriv, TORX® and Plus-Minus/Pozidriv Screwdriver Set with Rubber Grip - 14 Pcs



BE-9876S



14

1 BE-9876S

BE-8010S, BE-8220S, BE-8230S, BE-8040S, BE-8050S



BE-8611S, BE-8621S



BE-8811S, BE-8821S



BE-8910S, BE-8915S, BE-8920S



BE-8710S, BE-8720S



ERGO™ Slim VDE Insulated Slotted Screwdrivers with 3-Component Handle 3.0 mm-6.5 mm



BE-8220SL - BE-8255SL

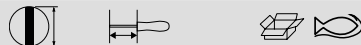

3.0 mm	100 mm	10	BE-8220SL
3.5 mm	100 mm	10	BE-8230SL
4.0 mm	100 mm	10	BE-8040SL
5.5 mm	125 mm	10	BE-8050SL
6.5 mm	150 mm	5	BE-8255SL

ERGO™ Slim VDE Insulated Phillips Screwdrivers with 3-Component Handle PH1-PH2



BE-8610SL - BE-8620SL



PH 1	80 mm	10	BE-8610SL
PH 2	100 mm	10	BE-8620SL

ERGO™ Slim VDE Insulated Pozidriv Screwdrivers with 3-Component Handle PZ1-PZ2



BE-8810SL - BE-8820SL



PZ 1	80 mm	10	BE-8810SL
PZ 2	100 mm	10	BE-8820SL

ERGO™ Slim VDE Insulated TORX® Screwdrivers with 3-Component Handle T10-T30



BE-8910SL - BE-8930SL

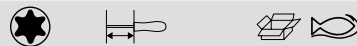

T 10	100 mm	5	BE-8910SL
T 15	100 mm	5	BE-8915SL
T 20	100 mm	5	BE-8920SL
T 25	125 mm	5	BE-8925SL
T 30	150 mm	5	BE-8930SL

ERGO™ Slim VDE Insulated Plus-Minus/Phillips-Tip Screwdrivers with 3-Component Handle for 5.0/PH1 - 6.0/PH2



BE-8510SL - BE-8520SL



5.0/PH1	80 mm	10	BE-8510SL
6.0/PH2	100 mm	10	BE-8520SL

ERGO™ Slim VDE Insulated Plus-Minus/Pozidriv-Tip Screwdrivers with 3-Component Handle 5.0/PZ1 - 6.0/PZ2



BE-8710SL - BE-8720SL



5.0/PZ1	80 mm	10	BE-8710SL
6.0/PZ2	100 mm	10	BE-8720SL

ERGO™ Slim VDE Insulated Plus-Minus/Pozidriv Screwdriver Set with 3-Component Handle - 2 Pcs



BE-9890SL



2	175 g	1	BE-9890SL
---	-------	---	-----------

BE-8710SL, BE-8720SL

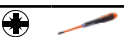

ERGO™ Slim VDE Insulated Phillips Screwdriver Set with 3-Component Handle - 2 Pcs



BE-9891SL



2	132 g	1	BE-9891SL
---	-------	---	-----------

BE-8610SL, BE-8620SL



ERGO™ Slim VDE Insulated Pozidriv Screwdriver Set with 3-Component Handle - 2 Pcs



ergo



BE-9894SL

X	g		
2	132 g	1	BE-9894SL

BE-8810SL, BE-8820SL

ERGO™ Slim VDE Insulated TORX® Screwdriver Set with 3-Component Handle - 4 Pcs



ergo



BE-9880SL

X			
4		1	BE-9880SL

BE-8910SL, BE-8915SL, BE-8920SL, BE-8925SL

ERGO™ Slim VDE Insulated Slotted and Phillips Screwdriver Set with 3-Component Handle - 5 Pcs



ergo



BE-9881SL

X			
5		1	BE-9881SL

BE-8220SL, BE-8040SL, BE-8050SL

BE-8610SL, BE-8620SL

ERGO™ Slim VDE Insulated Slotted and Pozidriv Screwdriver Set with 3-Component Handle - 5 Pcs



ergo

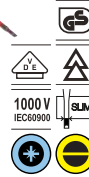

BE-9882SL

X			
5		1	BE-9882SL

BE-8220SL, BE-8040SL, BE-8050SL

BE-8810SL, BE-8820SL

ERGO™ Slim VDE Insulated Slotted, Phillips and Torx® Screwdriver Set with 3-Component Handle - 5 pcs



ergo

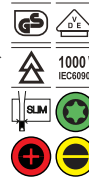

BE-9871SL

X			
5		1	BE-9871SL

BE-8220SL, BE-8040SL

BE-8910SL

BE-8610SL, BE-8620SL

ERGO™ Slim VDE Insulated Slotted, Pozidriv and Torx® Screwdriver Set with 3-Component Handle - 5 pcs



ergo



BE-9872SL

X			
5		1	BE-9872SL

BE-8220SL, BE-8040SL

BE-8910SL

BE-8810SL, BE-8820SL

ERGO™ Slim VDE Insulated Slotted, Phillips, Pozidriv, Torx and Plus-Minus/Phillips Screwdriver Set with 3-Component Handle - 12 Pcs



ergo



BE-9878SL

X			
12		1	BE-9878SL

BE-8010S

BE-8220SL, BE-8230SL, BE-8040SL, BE-8050SL

BE-8610SL, BE-8620SL

BE-8810SL, BE-8820SL

BE-8510SL, BE-8520SL

BE-8910SL

BahcoFit VDE Insulated Slotted Screwdrivers with Multi-Component Handle 2.5 mm-12 mm



B196

Length	Shaft Diameter	Tip Length	Part No.
2.5 mm	75 mm	10	B196.025.075
3 mm	100 mm	10	B196.030.100
3.5 mm	100 mm	10	B196.035.100
4 mm	100 mm	10	B196.040.100
5.5 mm	125 mm	10	B196.055.125
6.5 mm	150 mm	10	B196.065.150
8 mm	175 mm	10	B196.080.175
10 mm	200 mm	10	B196.100.200
12 mm	200 mm	10	B196.120.200
2.5 mm	75 mm	1	SB196.025.075
3 mm	100 mm	1	SB196.030.100
3.5 mm	100 mm	1	SB196.035.100
4 mm	100 mm	1	SB196.040.100
5.5 mm	125 mm	1	SB196.055.125
6.5 mm	150 mm	1	SB196.065.150
8 mm	175 mm	1	SB196.080.175
10 mm	200 mm	1	SB196.100.200
12 mm	200 mm	1	SB196.120.200



BahcoFit VDE Insulated Phillips
Screwdrivers with Multi-Component
Handle PH0-PH4



B197PH

Tip	Length	Qty	Part No.
PH0	75 mm	10	B197.000.075
PH1	80 mm	10	B197.001.080
PH1	150 mm	10	B197.001.150
PH2	100 mm	10	B197.002.100
PH2	175 mm	10	B197.002.175
PH3	150 mm	10	B197.003.150
PH4	200 mm	10	B197.004.200
PH0	75 mm	1	SB197.000.075
PH1	80 mm	1	SB197.001.080
PH2	100 mm	1	SB197.002.100
PH3	150 mm	1	SB197.003.150
PH4	200 mm	1	SB197.004.200

BahcoFit VDE Insulated Pozidriv
Screwdrivers with Multi-Component
Handle PZ0-PZ3



B142PZ

Tip	Length	Qty	Part No.
PZ0	75 mm	10	B142.000.075
PZ1	80 mm	10	B142.001.080
PZ1	150 mm	10	B142.001.150
PZ2	100 mm	10	B142.002.100
PZ2	175 mm	10	B142.002.175
PZ3	150 mm	10	B142.003.150
PZ0	75 mm	1	SB142.000.075
PZ1	80 mm	1	SB142.001.080
PZ2	100 mm	1	SB142.002.100
PZ3	150 mm	1	SB142.003.150

BahcoFit VDE Insulated TORX®
Screwdrivers with Multi-Component
Handle T10-T25



B150TORX

Tip	Length	Qty	Part No.
T10	100 mm	10	B150.010.100
T15	125 mm	10	B150.015.125
T20	125 mm	10	B150.020.125

Tip	Length	Qty	Part No.
T25	150 mm	10	B150.025.150
T10	100 mm	1	SB150.010.100
T15	125 mm	1	SB150.015.125
T20	125 mm	1	SB150.020.125
T25	150 mm	1	SB150.025.150

BahcoFit VDE Insulated Plus-Minus/
Phillips-Tip Screwdrivers with Multi-
Component Handle 5.0/PH1 - 6.0/PH2



B148

Tip	Length	Qty	Part No.
5.0mm/PH1	80 mm	10	B148.001.080
6.0mm/PH2	100 mm	10	B148.002.100
5.0mm/PH1	80 mm	1	SB148.001.080
6.0mm/PH2	100 mm	1	SB148.002.100

BahcoFit VDE Insulated Nut Drivers with
Multi-Component Handle 5.5 mm-13 mm



B199

Tip	Length	Qty	Part No.
5.5 mm	125 mm	5	B199.055.125
6 mm	125 mm	5	B199.060.125
7 mm	125 mm	5	B199.070.125
8 mm	125 mm	5	B199.080.125
9 mm	125 mm	5	B199.090.125
10 mm	125 mm	5	B199.100.125
11 mm	125 mm	5	B199.110.125
12 mm	125 mm	5	B199.120.125
13 mm	125 mm	5	B199.130.125
5.5 mm	125 mm	1	SB199.055.125
6 mm	125 mm	1	SB199.060.125
7 mm	125 mm	1	SB199.070.125
8 mm	125 mm	1	SB199.080.125
9 mm	125 mm	1	SB199.090.125
10 mm	125 mm	1	SB199.100.125
11 mm	125 mm	1	SB199.110.125
12 mm	125 mm	1	SB199.120.125
13 mm	125 mm	1	SB199.130.125

BahcoFit VDE Insulated Plus-Minus/
Pozidriv-Tip Screwdrivers with Multi-
Component Handle 5.0/PZ1-6.0/PZ2



B149

Tip	Length	Qty	Part No.
5.0mm/PZ1	80 mm	10	B149.001.080
6.0mm/PZ2	100 mm	10	B149.002.100
5.0mm/PZ1	80 mm	1	SB149.001.080
6.0mm/PZ2	100 mm	1	SB149.002.100

BahcoFit VDE Insulated Slotted and
Phillips Screwdriver Set with Multi-
Component Handle - 2 Pcs



B220.002

Tip	Weight	Qty	Part No.
X	90 g	1	B220.002

B196.030.100

B197.001.080

BahcoFit VDE Insulated Plus-Minus/
Pozidriv-Tip Screwdriver Set with Multi-
Component Handle - 2 Pcs



B220.012

Tip	Weight	Qty	Part No.
X	182 g	1	B220.012*

B149.001.080, B149.002.100

BahcoFit VDE Insulated Slotted and Phillips Screwdriver Set with Multi-Component Handle - 5 Pcs



B220.005



5 1 B220.005

B196.030.100, B196.040.100,
B196.055.125



B197.001.080, B197.002.100

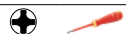

BahcoFit VDE Insulated Slotted and Pozidriv Screwdriver Set with Multi-Component Handle - 5 Pcs



B220.015



5 1 B220.015

B196.035.100, B196.040.100,
B196.065.150



B142.001.080, B142.002.100

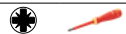

BahcoFit VDE Insulated Slotted and Phillips Screwdriver Set with Multi-Component Handle - 7 Pcs



B220.017



7 1 B220.017

B196.030.100, B196.040.100,
B196.055.125, B196.065.150

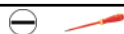

B197.000.075, B197.001.080,
B197.002.100

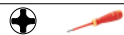

BahcoFit VDE Insulated Slotted and Pozidriv Screwdriver Set with Multi-Component Handle - 7 Pcs



B220.017



7 1 B220.017

B196.025.075, B196.040.100,
B196.055.125, B196.065.150

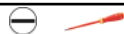

B142.000.075, B142.001.080,
B142.002.100

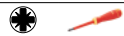

BahcoFit VDE Insulated Slotted and Phillips Screwdriver Set with Multi-Component Handle and 150 V-250 V Voltage Tester - 7 Pcs



B220.027



7 1 B220.027

B196.030.100, B196.040.100,
B196.055.125

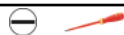

B197.000.075, B197.001.080,
B197.002.100

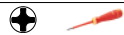

806-1-1



VDE Insulated Slotted Screwdrivers with Multi-Component Handle 3.0 mm-6.5 mm



623



3.0 mm	100 mm	10	623-3-100
3.5 mm	100 mm	10	623-3.5-100
4.0 mm	100 mm	10	623-4-100
5.5 mm	125 mm	10	623-5.5-125
6.5 mm	150 mm	10	623-6.5-150

VDE Insulated Phillips Screwdrivers with Multi-Component Handle PH0-PH2



625PH

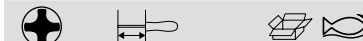

PH 0	100 mm	10	625-0-100
PH 1	150 mm	10	625-1-150
PH 2	175 mm	10	625-2-175

VDE Insulated Slotted and Phillips Screwdriver Set with Multi-Component Handle - 6 Pcs



620-6



6 1 620-6

623-4-100, 623-3-100, 623-5.5-125,
623-6.5-150



625-1-150, 625-2-175



* Until stocks last



Insulated Ratcheting Screwdriver with Slotted and Phillips Interchangeable Blades Set - 6 Pcs



808061

7	85 x 85 x 218 mm	5	808061

Pouch contains 6 individual blades

808060		
8610SL-2P, 8620SL-2P		
8010SL-2P, 8050SL-2P, 8220SL-2P, 8040SL-2P		

Insulated Ratcheting Screwdriver with Slotted and Pozidriv Interchangeable Blades Set - 6 Pcs



808062

7	85 x 85 x 215 mm	5	808062

Pouch contains 6 individual blades

808060		
8820SL-2P, 8810SL-2P		
8010SL-2P, 8050SL-2P, 8220SL-2P, 8040SL-2P		

Insulated Ratcheting Screwdriver with Dual-Component Handle



808060

36 mm	122 mm	1	808060

Insulated Slotted Interchangeable Blades with Reduced Diameter



8010SL-2P - 8050SL-2P

0.4 mm	2.5 mm	1	8010SL-2P
0.5 mm	3.0 mm	1	8220SL-2P
0.8 mm	4.0 mm	1	8040SL-2P
1.0 mm	5.5 mm	1	8050SL-2P

Insulated Phillips and Pozidriv Interchangeable Blades with Reduced Diameter PH1, PZ1



8610SL-2P - 8620SL-2P

1		1	8610SL-2P
2		1	8620SL-2P

Insulated Phillips and Pozidriv Interchangeable Blades with Reduced Diameter PH2, PZ2



8810SL-2P - 8820SL-2P

1		1	8810SL-2P
2		1	8820SL-2P

Insulated Plus-Minus/Phillips-Tip Interchangeable Blades with Reduced Diameter



8510SL-2P - 8520SL-2P

5.0/PH1		1	8510SL-2P
6.0/PH2		1	8520SL-2P

Insulated Combi-Tip Slotted and Pozidriv Interchangeable Blades with Reduced Diameter



8710SL-2P - 8720SL-2P

5.0/PZ1		1	8710SL-2P
6.0/PZ2		1	8720SL-2P

Insulated TORX® Interchangeable Blades with Reduced Diameter



8910SL-2P - 8930SL-2P

10		1	8910SL-2P
15		1	8915SL-2P
20		1	8920SL-2P
25		1	8925SL-2P
30		1	8930SL-2P

PLIERS

ERGO™ Side Cutting Pliers with Insulated Handles and Phosphate Finish



2101S

3.7 mm	2.0 mm	3	2101S-140
3.8 mm	2.5 mm	3	2101S-160
4.0 mm	2.7 mm	3	2101S-180

ERGO™ Side Cutting Pliers with Insulated Handles and Phosphate Finish 200 mm



2101S-200



4.5 mm	3.0 mm	3	2101S-200

VDE Insulated Cable Cutters



2250V



170 mm 230 mm	0-10 mm 0-15 mm	2 2	2250V-170 2250V-230

ERGO™ Combination Pliers with Insulated Dual-Component Handles and Phosphate Finish



2628S



2.0 mm 2.5 mm 3.0 mm	1.8 mm 2.0 mm 2.5 mm	3 3 3	2628 S-160 2628 S-180 2628 S-200

VDE Insulated Side Cutting Pliers



2171V



2.7 mm 2.8 mm 4.0 mm	160 mm 180 mm 200 mm	2 2 2	2171V-160 2171V-180 2171V-200

Insulated Bolt Cutters



2820VBC



630 mm	1	2820VBC

Reinforced Combination Pliers with Insulated Dual-Component Handles and Chrome Finish



2630SC



180 mm	3	2630SC-180

VDE Insulated End Cutting Pliers



527V



2 mm 2.5 mm	160 mm 200 mm	2 2	527V-160 527V-200

Side Cutting Pliers with Insulated Cellulose Acetate Handles and Nickel-Chrome Finish



2674 NVDE



3.7 mm	2.0 mm	1	2674 NVDE

VDE Insulated Combination Pliers



2678V



2.7 mm 3.0 mm 4.0 mm	160 mm 180 mm 200 mm	2 2 2	2678V-160 2678V-180 2678V-200



ERGO™ Snipe Nose Pliers with Insulated Dual-Component Handles and Phosphate Finish



2430S

Tip	Length	Quantity	Model
2.5 mm	180 mm	3	2430S-180
3.0 mm	180 mm	3	2430 S-180
3.0 mm	200 mm	3	2430 S-200

ERGO™ Round Nose Pliers with Insulated Dual-Component Handles and Phosphate Finish



2521S

Tip	Length	Quantity	Model
140 mm	160 mm	3	2521S-140
160 mm	160 mm	3	2521S-160

VDE Insulated Long Flat Nose Pliers



2421V

Tip	Length	Quantity	Model
160 mm	160 mm	2	2421V-160

ERGO™ 45° Bent Tip Snipe Nose Pliers with Insulated Dual-Component Handles and Phosphate Finish



2427S

Tip	Length	Quantity	Model
3.0 mm	180 mm	3	2427S-180
3.0 mm	200 mm	3	2427 S-200

VDE Insulated Snipe Nose Pliers



2430V

Tip	Length	Quantity	Model
3.0 mm	160 mm	2	2430V-160
3.0 mm	200 mm	2	2430V-200

VDE Insulated Round Nose Pliers



2521V

Tip	Length	Quantity	Model
160 mm	160 mm	2	2521V-160

ERGO™ Long Flat Nose Pliers with Insulated Dual-Component Handles and Phosphate Finish



2421S

Tip	Length	Quantity	Model
140 mm	180 mm	3	2421S-140
160 mm	180 mm	3	2421S-160
180 mm	180 mm	3	2421S-180

VDE Insulated 45° Tip Angled Snipe Nose Pliers



2427V

Tip	Length	Quantity	Model
3.0 mm	200 mm	2	2427V-200

ERGO™ Wire Stripping Pliers with Insulated Dual-Component Handles and Phosphate Finish



2223S

Tip	Length	Quantity	Model
165 mm	150 mm	3	2223 S-150

VDE Insulated Wire Stripping Pliers



2223V

160 mm	0.5-5 mm	2	2223V-160



Insulated Quick-Adjust Water Pump Pliers with Dual-Component Handle



7224S

16	250 mm	4 7224S



ISO 8976, IEC 60900

WRENCHES

Insulated Thumb Screw Adjustable Wrenches



8070V - 8074V

165mm/6"	2	8070V
205mm/8"	2	8071V
260mm/10"	2	8072V
310mm/12"	2	8073V
390mm/15"	2	8074V



Insulated Side Screw Adjustable Wrenches



8070VL-8073VL

160mm/6"	1	8070VL
210mm/8"	1	8071VL
260mm/10"	1	8072VL
310mm/12"	1	8073VL



Side Screw Insulated Adjustable Wrenches



8071VLT - 8073VLT

205mm/8"	1	8071VLT
255mm/10"	1	8072VLT
305mm/12"	1	8073VLT



Insulated Open End Wrenches



6MV

6 mm	5	6MV-6
7 mm	5	6MV-7
8 mm	5	6MV-8
9 mm	5	6MV-9
10 mm	5	6MV-10
11 mm	5	6MV-11
12 mm	5	6MV-12
13 mm	5	6MV-13
14 mm	5	6MV-14
15 mm	5	6MV-15
16 mm	5	6MV-16
17 mm	3	6MV-17
18 mm	3	6MV-18
19 mm	3	6MV-19
20 mm	3	6MV-20
21 mm	3	6MV-21
22 mm	3	6MV-22
23 mm	3	6MV-23
24 mm	3	6MV-24



27 mm	2	6MV-27
30 mm	2	6MV-30
32 mm	2	6MV-32

Insulated Offset Ring Spanners



2MV

6.0 mm	5	2MV-6
7.0 mm	5	2MV-7
8.0 mm	5	2MV-8
9.0 mm	5	2MV-9
10.0 mm	5	2MV-10
11.0 mm	5	2MV-11
12.0 mm	5	2MV-12
13.0 mm	5	2MV-13
14.0 mm	5	2MV-14
15.0 mm	5	2MV-15
16.0 mm	5	2MV-16
17.0 mm	3	2MV-17
18.0 mm	3	2MV-18
19.0 mm	3	2MV-19
21.0 mm	3	2MV-21
22.0 mm	3	2MV-22
23.0 mm	3	2MV-23
24.0 mm	3	2MV-24



Insulated T-Handle Socket Wrenches



28MV

8.0 mm	2	28MV-8
9.0 mm	2	28MV-9
10.0 mm	2	28MV-10
11.0 mm	2	28MV-11
12.0 mm	2	28MV-12
13.0 mm	2	28MV-13
14.0 mm	2	28MV-14
15.0 mm	2	28MV-15
16.0 mm	2	28MV-16
17.0 mm	2	28MV-17
18.0 mm	2	28MV-18
19.0 mm	2	28MV-19
20.0 mm	2	28MV-20
21.0 mm	2	28MV-21
22.0 mm	2	28MV-22



Insulated Hexagon L-Keys



1999MV



3 mm	5	1999MV-3
4 mm	5	1999MV-4
5 mm	5	1999MV-5
6 mm	5	1999MV-6
7 mm	5	1999MV-7
8 mm	5	1999MV-8
9 mm	5	1999MV-9
10 mm	3	1999MV-10
12 mm	3	1999MV-12

INSULATED SOCKETS & RATCHETS

1/2" VDE Insulated Sockets 8 mm-32 mm



7800DMV



8 mm	10	7800DMV-8
10 mm	10	7800DMV-10
11 mm	10	7800DMV-11
12 mm	10	7800DMV-12
13 mm	10	7800DMV-13
14 mm	10	7800DMV-14
15 mm	10	7800DMV-15
16 mm	10	7800DMV-16
17 mm	10	7800DMV-17
18 mm	10	7800DMV-18
19 mm	10	7800DMV-19
20 mm	10	7800DMV-20
21 mm	10	7800DMV-21
22 mm	10	7800DMV-22
24 mm	5	7800DMV-24
27 mm	5	7800DMV-27
30 mm	5	7800DMV-30
32 mm	5	7800DMV-32

1/2" VDE Insulated Ratchets 270 mm



8150-1/2V



270 mm	1	8150-1/2V
--------	---	-----------

1/2" VDE Insulated T-Handles 200 mm



8154-1/2V



200 mm	190 mm	1	8154-1/2V
--------	--------	---	-----------

1/2" VDE Insulated Extensions 125 mm-250 mm



8160-1/2V - 8162-1/2V



125 mm	1	8160-1/2V
250 mm	1	8162-1/2V

SCISSORS & KNIVES

Insulated Electrician Scissors with Finger Guard



SC127V



50 mm	130 mm	5	SC127V
-------	--------	---	--------

Insulated Electrician Scissors



SC150NGV



38 mm	150 mm	5	SC150NGV
-------	--------	---	----------

Insulated Straight Knives



2820VP



50 mm	180 mm	2	2820VP
-------	--------	---	--------

VDE Insulated Bent Knives



2820VPC



50 mm	180 mm	2	2820VPC

Insulated Cable Knives with Plastic Protective Cap



2820VDE



55.5 mm	180 mm	10	2820VDE

TWEEZERS

General Purpose Insulated Tweezers 150 mm



2820VTEE



	145 mm	1	2820VTEE

PROTECTIVE EQUIPMENT

Insulated Fuse Pullers for NH 00-3



2820VFP



458 g	1	2820VFP

Insulating Mats for 1000VAC



2820VM



1000 mm	1000 mm	1	2820VM

Insulating Gloves 550 VAC-1000 VAC



2820VG



500 V	1	2820VG05
1000 V	1	2820VG10

Cotton Gloves to Wear Under Insulated Gloves



2820VGCOT

50 g	1	2820VGCOT

THIS ITEM IS NOT INSULATED AND HAS TO BE USED WITH INSULATED GLOVES

TOOLSETS

ERGO™ All-Round Pliers Tool Set Insulated - 3 pcs



9897S/3



3	50 x 180 x 400 mm	1	9897S/3

2628 S-180



2101S-160



2430 S-200



Insulated Open End Wrench Set - 8 Pcs



6MV/



8 mm

1 6MV/8T

6MV-10, 6MV-11, 6MV-12, 6MV-13,
6MV-14, 6MV-17, 6MV-18, 6MV-19



Insulated Open End Wrench Set - 10 Pcs



6MV/10T 1



10 mm

1 6MV/10T

6MV-10, 6MV-11, 6MV-12, 6MV-13,
6MV-14, 6MV-16, 6MV-17, 6MV-18,
6MV-19, 6MV-22



1/2" VDE Insulated Socket Set - 11 Pcs



7811DMV



11

270 x 79 x 350 mm

1 7811DMV

BAHCO

Insulated Toolset within Leather Bag - 19 Pcs



3045V-2



19

200 x 285 x 445 mm

1 3045V-2

2171V-160



2678V-180



2430V-160



2223V-160



BE-8220S, BE-8040S, BE-8050S,
BE-8255S



BE-8610S, BE-8620S



6MV-10, 6MV-11, 6MV-13, 6MV-12,
6MV-14, 6MV-17, 6MV-19



2820VP



SC150NGV



Foldable Case Insulated Electrician's Toolset - 10 Pcs



3045/1VDE



10

225 x 70 x 300 mm

1 3045/1VDE

BE-8010S, BE-8040S, BE-8050S, BE-
8220S, BE-8230S, BE-8255S



BE-8620S



2171V-160

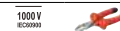

2430V-160



2678V-180



Leather Briefcase Insulated Electrician's Toolset - 10 Pcs



3045V-1



10

60 x 240 x 330 mm

1 3045V-1

2171V-160



2678V-180



2223V-160



BE-8220S, BE-8040S, BE-8050S



BE-8610S, BE-8620S



2820VP

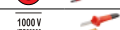

SC127V





Non Sparking Tools



WRENCHES

Non-Sparking Central Nut Adjustable
Wrenches Aluminium Bronze



NS001

Icon	L	Icon	Icon
18 mm	150mm/6"	5	NS001-150
24 mm	200mm/8"	5	NS001-200
30 mm	250mm/10"	5	NS001-250
36 mm	300mm/12"	5	NS001-300
46 mm	375mm/15"	5	NS001-375
55 mm	450mm/18"	3	NS001-450
65 mm	600mm/24"	1	NS001-600
75 mm	900mm/36"	1	NS001-900

Non-Sparking Central Nut Adjustable
Wrenches Copper Beryllium



NSB001

Icon	L	Icon	Icon
18 mm	150mm/6"	5	NSB001-150
24 mm	200mm/8"	5	NSB001-200
30 mm	250mm/10"	5	NSB001-250
36 mm	300mm/12"	5	NSB001-300
48 mm	375mm/15"	5	NSB001-375
55 mm	450mm/18"	3	NSB001-450
65 mm	600mm/24"	3	NSB001-600
75 mm	900mm/36"	1	NSB001-900

BAM/ZBF/003/21

Non-Sparking Metric Combination
Wrenches Aluminium Bronze



NS002

Icon	Icon	Icon
6 mm	5	NS002-6
7 mm	5	NS002-7
8 mm	5	NS002-8
9 mm	5	NS002-9
10 mm	10	NS002-10
11 mm	5	NS002-11
12 mm	5	NS002-12



13 mm	10	NS002-13
14 mm	5	NS002-14
15 mm	5	NS002-15
16 mm	5	NS002-16
17 mm	10	NS002-17
18 mm	5	NS002-18
19 mm	10	NS002-19
20 mm	5	NS002-20
21 mm	5	NS002-21
22 mm	10	NS002-22
23 mm	5	NS002-23
24 mm	10	NS002-24
25 mm	5	NS002-25
26 mm	5	NS002-26
27 mm	5	NS002-27
28 mm	5	NS002-28
29 mm	10	NS002-29
30 mm	10	NS002-30
31 mm	5	NS002-31
32 mm	5	NS002-32
33 mm	5	NS002-33
34 mm	5	NS002-34
35 mm	5	NS002-35
36 mm	5	NS002-36
38 mm	5	NS002-38
40 mm	5	NS002-40
41 mm	5	NS002-41
42 mm	5	NS002-42
46 mm	5	NS002-46
50 mm	5	NS002-50
52 mm	5	NS002-52
55 mm	5	NS002-55
60 mm	1	NS002-60
65 mm	1	NS002-65
70 mm	1	NS002-70*
75 mm	1	NS002-75
80 mm	1	NS002-80*

BAM/ZBF/002/21

Non-Sparking Metric Combination
Wrenches Copper Beryllium



NSB002

Icon	Icon	Icon
6 mm	5	NSB002-6
7 mm	5	NSB002-7
8 mm	5	NSB002-8
9 mm	5	NSB002-9
10 mm	5	NSB002-10
11 mm	5	NSB002-11
12 mm	5	NSB002-12
13 mm	5	NSB002-13
17 mm	5	NSB002-17
14 mm	5	NSB002-14
15 mm	5	NSB002-15
16 mm	5	NSB002-16
18 mm	5	NSB002-18
19 mm	5	NSB002-19
20 mm	5	NSB002-20
21 mm	5	NSB002-21
22 mm	5	NSB002-22
25 mm	5	NSB002-25
23 mm	5	NSB002-23
26 mm	5	NSB002-26
24 mm	5	NSB002-24
27 mm	5	NSB002-27
28 mm	5	NSB002-28



29 mm	5	NSB002-29
30 mm	5	NSB002-30
31 mm	1	NSB002-31
32 mm	10	NSB002-32
33 mm	1	NSB002-33
34 mm	1	NSB002-34
35 mm	1	NSB002-35
36 mm	5	NSB002-36
38 mm	1	NSB002-38
40 mm	1	NSB002-40
41 mm	5	NSB002-41
42 mm	1	NSB002-42
46 mm	1	NSB002-46
50 mm	1	NSB002-50
52 mm	1	NSB002-52*
55 mm	1	NSB002-55*
60 mm	1	NSB002-60*
65 mm	1	NSB002-65*
70 mm	1	NSB002-70*
75 mm	1	NSB002-75*
80 mm	1	NSB002-80*

BAM/ZBF/003/21

Non-Sparking Imperial Combination
Wrenches Aluminium Bronze



NS003



Icon	Icon	Icon
1/4 in	1	NS003-8*
11/32 in	1	NS003-11*
3/8 in	1	NS003-12*
7/16 in	1	NS003-14*
1/2 in	1	NS003-16
9/16 in	1	NS003-18
5/8 in	1	NS003-20*
3/4 in	1	NS003-24*
7/8 in	1	NS003-28
15/16 in	1	NS003-30

Non-Sparking Imperial Combination
Wrenches Copper Beryllium



NSB003

Icon	Icon	Icon
1/4 in	1	NSB003-8*
5/16 in	1	NSB003-10
11/32 in	1	NSB003-11
3/8 in	5	NSB003-12
13/32 in	1	NSB003-13*
7/16 in	1	NSB003-14



	 	
1/2 in	5	NSB003-16
9/16 in	1	NSB003-18
19/32 in	1	NSB003-19*
5/8 in	1	NSB003-20
11/16 in	5	NSB003-22
3/4 in	5	NSB003-24
25/32 in	1	NSB003-25*
13/16 in	1	NSB003-26*
7/8 in	5	NSB003-28*
15/16 in	1	NSB003-30
31/32 in	1	NSB003-31*
1 in	1	NSB003-32
1.1/16 in	1	NSB003-34
1.1/8 in	1	NSB003-36
1.3/16 in	1	NSB003-38*
1.1/4 in	1	NSB003-40
1.5/16 in	1	NSB003-42
1.3/8 in	5	NSB003-44*
1.7/16 in	1	NSB003-46*
1.1/2 in	1	NSB003-48*
1.9/16 in	1	NSB003-50*
1.5/8 in	1	NSB003-52
1.11/16 in	1	NSB003-54*
1.3/4 in	1	NSB003-56*
1.13/16 in	1	NSB003-58*
1.7/8 in	1	NSB003-60*
1.15/16 in	1	NSB003-62*
2 in	5	NSB003-64*
2.1/8 in	1	NSB003-68*
2.1/4 in	1	NSB003-72*
2.1/2 in	1	NSB003-80*
2.5/8 in	1	NSB003-84
2.3/4 in	1	NSB003-88



BAM/ZBF/003/21

Non-Sparking Metric Double Open Ended Wrenches Aluminium Bronze



NS006

	 	
6x7 mm	1	NS006-0607
6x8 mm	1	NS006-0608
7x8 mm	1	NS006-0708
7x9 mm	1	NS006-0709
8x9 mm	1	NS006-0809
8x10 mm	1	NS006-0810
9x10 mm	1	NS006-0910*
9x11 mm	1	NS006-0911
10x11 mm	1	NS006-1011
10x12 mm	1	NS006-1012
10x13 mm	1	NS006-1013
10x14 mm	1	NS006-1014*
11x13 mm	1	NS006-1113
11x14 mm	1	NS006-1114
12x13 mm	1	NS006-1213
12x14 mm	1	NS006-1214
13x15 mm	1	NS006-1315
14x15 mm	1	NS006-1415
14x16 mm	1	NS006-1416
14x17 mm	1	NS006-1417



	 	
16x17 mm	1	NS006-1617
16x18 mm	1	NS006-1618
17x19 mm	1	NS006-1719
17x22 mm	1	NS006-1722*
18x19 mm	1	NS006-1819
18x20 mm	1	NS006-1820*
19x20 mm	1	NS006-1920
19x22 mm	1	NS006-1922
19x24 mm	1	NS006-1924
20x22 mm	1	NS006-2022
21x22 mm	1	NS006-2122
21x23 mm	1	NS006-2123
22x23 mm	1	NS006-2223
22x24 mm	1	NS006-2224
22x27 mm	1	NS006-2227
23x26 mm	1	NS006-2326
24x25 mm	1	NS006-2425
24x26 mm	1	NS006-2426
24x27 mm	1	NS006-2427
24x30 mm	1	NS006-2430
25x28 mm	1	NS006-2528
26x29 mm	1	NS006-2629*
27x29 mm	1	NS006-2729
27x30 mm	1	NS006-2730
27x32 mm	1	NS006-2732
28x30 mm	1	NS006-2830
30x31 mm	1	NS006-3031
30x32 mm	1	NS006-3032
30x34 mm	1	NS006-3034*
30x36 mm	1	NS006-3036
32x34 mm	1	NS006-3234
32x35 mm	1	NS006-3235
32x36 mm	1	NS006-3236
33x35 mm	1	NS006-3335
34x36 mm	1	NS006-3436
35x36 mm	1	NS006-3536
36x38 mm	1	NS006-3638
36x41 mm	1	NS006-3641
38x42 mm	1	NS006-3642
41x46 mm	1	NS006-4146
46x50 mm	1	NS006-4650
50x52 mm	1	NS006-5052*
50x55 mm	1	NS006-5055
50x60 mm	1	NS006-5060*
50x62 mm	1	NS006-5062*
55x60 mm	1	NS006-5560
60x65 mm	1	NS006-6065
65x70 mm	1	NS006-6570*



BAM/ZBF/002/21

Non-Sparking Metric Double Open Ended Wrenches Copper Beryllium



NSB006

	 	
6X7 mm	1	NSB006-0607
6X8 mm	1	NSB006-0608*
7X8 mm	1	NSB006-0708

	 	
7X9 mm	1	NSB006-0709*
8X9 mm	1	NSB006-0809
8X10 mm	1	NSB006-0810
9X10 mm	1	NSB006-0910
9X11 mm	1	NSB006-0911
10X11 mm	1	NSB006-1011
10X12 mm	1	NSB006-1012
10X13 mm	1	NSB006-1013
10X14 mm	1	NSB006-1014
11X13 mm	1	NSB006-1113
11X14 mm	1	NSB006-1114*
12X13 mm	1	NSB006-1213
12X14 mm	1	NSB006-1214
13X15 mm	1	NSB006-1315
14X15 mm	1	NSB006-1415
14X16 mm	1	NSB006-1416
14X17 mm	1	NSB006-1417
16X17 mm	1	NSB006-1617
16X18 mm	1	NSB006-1618
17X19 mm	1	NSB006-1719
17X22 mm	1	NSB006-1722*
18X19 mm	1	NSB006-1819
18X20 mm	1	NSB006-1820*
19X20 mm	1	NSB006-1920
19X22 mm	1	NSB006-1922
19X24 mm	1	NSB006-1924*
20X22 mm	1	NSB006-2022
21X22 mm	1	NSB006-2122
21X23 mm	1	NSB006-2123
22X23 mm	1	NSB006-2223
22X24 mm	1	NSB006-2224
22X27 mm	1	NSB006-2227*
23X26 mm	1	NSB006-2326
24X25 mm	1	NSB006-2425
24X26 mm	1	NSB006-2426
24X27 mm	1	NSB006-2427
24X30 mm	1	NSB006-2430
25x28 mm	1	NSB006-2528
26x29 mm	1	NSB006-2629*
27-29 mm	1	NSB006-2729
27x30 mm	1	NSB006-2730
27x32 mm	1	NSB006-2732
28x30 mm	1	NSB006-2830
30x31 mm	1	NSB006-3031
30x32 mm	1	NSB006-3032
30x34 mm	1	NSB006-3034*
30x36 mm	1	NSB006-3036
32x34 mm	1	NSB006-3234
32x35 mm	1	NSB006-3235
32x36 mm	1	NSB006-3236
33x35 mm	1	NSB006-3335*
34x36 mm	1	NSB006-3436
35x36 mm	1	NSB006-3536*
36x38 mm	1	NSB006-3638
36x41 mm	1	NSB006-3641
38x42 mm	1	NSB006-3642*
41x46 mm	1	NSB006-4146
46x50 mm	1	NSB006-4650
50x52 mm	1	NSB006-5052*
50X55 mm	1	NSB006-5055*
50X60 mm	1	NSB006-5060*
50X62 mm	1	NSB006-5062*
55X60 mm	1	NSB006-5560*
60X65 mm	1	NSB006-6065*
65X70 mm	1	NSB006-6570*

BAM/ZBF/003/21

* Until stocks last



Non-Sparking Metric Double Ended Flat Ring Wrenches Aluminium Bronze



NS010

NS010	
6x7 mm	1 NS010-0607*
7x9 mm	1 NS010-0709*
8x9 mm	1 NS010-0809
9x11 mm	1 NS010-0911*
10x11 mm	1 NS010-1011
10x12 mm	1 NS010-1012
12x14 mm	1 NS010-1214
13x15 mm	1 NS010-1315
14x17 mm	1 NS010-1417
16x18 mm	1 NS010-1618
17x19 mm	1 NS010-1719
17x22 mm	1 NS010-1722*
18x19 mm	1 NS010-1819
19x21 mm	1 NS010-1921
19x22 mm	1 NS010-1922
20x22 mm	1 NS010-2022
21x23 mm	1 NS010-2123*
22x24 mm	1 NS010-2224
24x27 mm	1 NS010-2427
25x28 mm	1 NS010-2528*
26x28 mm	1 NS010-2628
27x30 mm	1 NS010-2730
27x32 mm	1 NS010-2732
30x32 mm	1 NS010-3032
30x36 mm	1 NS010-3036
32x36 mm	1 NS010-3236
36x41 mm	1 NS010-3641
41x46 mm	1 NS010-4146*
46x50 mm	1 NS010-4650*

BAM/ZBF/002/21

Non-Sparking Metric Double Ended Flat Ring Wrenches Copper Beryllium



NSB010

NSB010	
6X7 mm	1 NSB010-0607
7X9 mm	1 NSB010-0709*
8X9 mm	1 NSB010-0809
9X11 mm	1 NSB010-0911*

NS010	
10X11 mm	1 NSB010-1011
10X12 mm	1 NSB010-1012*
12X14 mm	1 NSB010-1214
13X15 mm	1 NSB010-1315*
14X17 mm	1 NSB010-1417*
16X18 mm	1 NSB010-1618
17X19 mm	1 NSB010-1719
17X22 mm	1 NSB010-1722*
18X19 mm	1 NSB010-1819*
19X21 mm	1 NSB010-1921*
19X22 mm	1 NSB010-1922
20X22 mm	1 NSB010-2022
21X23 mm	1 NSB010-2123*
22X24 mm	1 NSB010-2224*
24X27 mm	1 NSB010-2427
25X28 mm	1 NSB010-2528*
26X28 mm	1 NSB010-2628*
27X30 mm	1 NSB010-2730*
27X32 mm	1 NSB010-2732*
30X32 mm	1 NSB010-3032
30X36 mm	1 NSB010-3036*
32X36 mm	1 NSB010-3236*
36X41 mm	1 NSB010-3641
41X46 mm	1 NSB010-4146
46X50 mm	1 NSB010-4650*

BAM/ZBF/003/21

Non-Sparking Metric Double Ended Offset Ring Wrenches Aluminium Bronze



NS011

NS011	
6x7 mm	1 NS011-0607
8x9 mm	1 NS011-0809
10x11 mm	1 NS011-1011
12x13 mm	1 NS011-1213
14x15 mm	1 NS011-1415
16x17 mm	1 NS011-1617
18x19 mm	1 NS011-1819
20x22 mm	1 NS011-2022
21x23 mm	1 NS011-2123
24x26 mm	1 NS011-2426
25x28 mm	1 NS011-2528
27x29 mm	1 NS011-2729
30x32 mm	1 NS011-3032

BAM/ZBF/002/21

Non-Sparking Metric Double Ended Offset Ring Wrenches Copper Beryllium



NSB011

NSB011	
6x7 mm	1 NSB011-0607
8x9 mm	1 NSB011-0809
10x11 mm	1 NSB011-1011
12x13 mm	1 NSB011-1213
14x15 mm	1 NSB011-1415
16x17 mm	1 NSB011-1617
18x19 mm	1 NSB011-1819
20x22 mm	1 NSB011-2022
21x23 mm	1 NSB011-2123
24x26 mm	1 NSB011-2426
25x28 mm	1 NSB011-2528*
27x29 mm	1 NSB011-2729*
30x32 mm	1 NSB011-3032



BAM/ZBF/003/21

Non-Sparking Metric Slogging Open Wrenches Aluminium Bronze



NS100

NS100	
17 mm	1 NS100-17
19 mm	1 NS100-19
22 mm	1 NS100-22
24 mm	1 NS100-24
25 mm	1 NS100-25*
27 mm	1 NS100-27
28 mm	1 NS100-28
29 mm	1 NS100-29*
30 mm	1 NS100-30
32 mm	1 NS100-32
33 mm	1 NS100-33*
34 mm	1 NS100-34
35 mm	1 NS100-35*
36 mm	1 NS100-36



		
37 mm	1	NS100-37*
38 mm	1	NS100-38
41 mm	1	NS100-41
42 mm	1	NS100-42
45 mm	1	NS100-45*
46 mm	1	NS100-46
47 mm	1	NS100-47*
50 mm	1	NS100-50
52 mm	1	NS100-52
54 mm	1	NS100-54
55 mm	1	NS100-55
56 mm	1	NS100-56
58 mm	1	NS100-58
60 mm	1	NS100-60
63 mm	1	NS100-63*
65 mm	1	NS100-65
67 mm	1	NS100-67*
70 mm	1	NS100-70
71 mm	1	NS100-71*
75 mm	1	NS100-75
77 mm	1	NS100-77*
80 mm	1	NS100-80
82 mm	1	NS100-82
85 mm	1	NS100-85
88 mm	1	NS100-88*
90 mm	1	NS100-90
94 mm	1	NS100-94*
95 mm	1	NS100-95
100 mm	1	NS100-100
105 mm	1	NS100-105
110 mm	1	NS100-110
115 mm	1	NS100-115
120 mm	1	NS100-120



BAM/ZBF/002/21

Non-Sparking Metric Slogging Open Wrenches Copper Beryllium



NSB100

		
17 mm	1	NSB100-17*
19 mm	1	NSB100-19*
22 mm	1	NSB100-22
24 mm	1	NSB100-24
25 mm	1	NSB100-25
27 mm	1	NSB100-27
28 mm	1	NSB100-28
29 mm	1	NSB100-29*
30 mm	1	NSB100-30
32 mm	1	NSB100-32
33 mm	1	NSB100-33
34 mm	1	NSB100-34*
35 mm	1	NSB100-35
36 mm	1	NSB100-36



		
37 mm	1	NSB100-37*
38 mm	1	NSB100-38
41 mm	1	NSB100-41
42 mm	1	NSB100-42
45 mm	1	NSB100-45
46 mm	1	NSB100-46
47 mm	1	NSB100-47*
50 mm	1	NSB100-50
52 mm	1	NSB100-52
54 mm	1	NSB100-54*
55 mm	1	NSB100-55
56 mm	1	NSB100-56*
58 mm	1	NSB100-58*
60 mm	1	NSB100-60*
63 mm	1	NSB100-63
65 mm	1	NSB100-65
67 mm	1	NSB100-67*
70 mm	1	NSB100-70*
71 mm	1	NSB100-71*
75 mm	1	NSB100-75*
77 mm	1	NSB100-77*
80 mm	1	NSB100-80
82 mm	1	NSB100-82
85 mm	1	NSB100-85*
88 mm	1	NSB100-88*
90 mm	1	NSB100-90
94 mm	1	NSB100-94*
95 mm	1	NSB100-95*
100 mm	1	NSB100-100*
105 mm	1	NSB100-105*
110 mm	1	NSB100-110*
115 mm	1	NSB100-115*
120 mm	1	NSB100-120*



BAM/ZBF/003/21

Non-Sparking Metric Slogging Ring Wrenches Aluminium Bronze



NS104

		
17 mm	1	NS104-17
19 mm	1	NS104-19
20 mm	1	NS104-20*
22 mm	1	NS104-22
24 mm	1	NS104-24
25 mm	1	NS104-25*
26 mm	1	NS104-26
27 mm	1	NS104-27
28 mm	1	NS104-28
29 mm	1	NS104-29
30 mm	1	NS104-30
31 mm	1	NS104-31
32 mm	1	NS104-32

		
33 mm	1	NS104-33
34 mm	1	NS104-34
35 mm	1	NS104-35
36 mm	1	NS104-36
37 mm	1	NS104-37
38 mm	1	NS104-38
39 mm	1	NS104-39
40 mm	1	NS104-40
41 mm	1	NS104-41
42 mm	1	NS104-42
43 mm	1	NS104-43*
44 mm	1	NS104-44*
45 mm	1	NS104-45*
46 mm	1	NS104-46
47 mm	1	NS104-47
48 mm	1	NS104-48
49 mm	1	NS104-49
50 mm	1	NS104-50
51 mm	1	NS104-51
52 mm	1	NS104-52
53 mm	1	NS104-53*
54 mm	1	NS104-54
55 mm	1	NS104-55
56 mm	1	NS104-56
57 mm	1	NS104-57
58 mm	1	NS104-58*
59 mm	1	NS104-59*
60 mm	1	NS104-60
61 mm	1	NS104-61*
62 mm	1	NS104-62*
63 mm	1	NS104-63
64 mm	1	NS104-64*
65 mm	1	NS104-65
66 mm	1	NS104-66*
67 mm	1	NS104-67*
68 mm	1	NS104-68*
69 mm	1	NS104-69*
70 mm	1	NS104-70
71 mm	1	NS104-71*
72 mm	1	NS104-72*
73 mm	1	NS104-73*
74 mm	1	NS104-74*
75 mm	1	NS104-75
76 mm	1	NS104-76*
77 mm	1	NS104-77*
78 mm	1	NS104-78*
79 mm	1	NS104-79*
80 mm	1	NS104-80
81 mm	1	NS104-81*
82 mm	1	NS104-82*
83 mm	1	NS104-83*
84 mm	1	NS104-84*
85 mm	1	NS104-85
86 mm	1	NS104-86*
87 mm	1	NS104-87*
88 mm	1	NS104-88*
89 mm	1	NS104-89*
90 mm	1	NS104-90
92 mm	1	NS104-92*
94 mm	1	NS104-94*
95 mm	1	NS104-95
98 mm	1	NS104-98*
100 mm	1	NS104-100
105 mm	1	NS104-105
110 mm	1	NS104-110
115 mm	1	NS104-115
120 mm	1	NS104-120

BAM/ZBF/002/21

* Until stocks last



Non-Sparking Metric Slogging Ring
Wrenches Copper Beryllium



NSB104

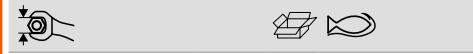

17 mm	1	NSB104-17
19 mm	1	NSB104-19
20 mm	1	NSB104-20*
22 mm	1	NSB104-22*
24 mm	1	NSB104-24
25 mm	1	NSB104-25*
26 mm	1	NSB104-26*
27 mm	1	NSB104-27
28 mm	1	NSB104-28*
29 mm	1	NSB104-29
30 mm	1	NSB104-30
31 mm	1	NSB104-31*
32 mm	1	NSB104-32
33 mm	1	NSB104-33*
34 mm	1	NSB104-34*
35 mm	1	NSB104-35*
36 mm	1	NSB104-36
37 mm	1	NSB104-37
38 mm	1	NSB104-38
39 mm	1	NSB104-39*
40 mm	1	NSB104-40*
41 mm	1	NSB104-41
42 mm	1	NSB104-42
43 mm	1	NSB104-43*
44 mm	1	NSB104-44
45 mm	1	NSB104-45*
46 mm	1	NSB104-46
47 mm	1	NSB104-47*
48 mm	1	NSB104-48
49 mm	1	NSB104-49
50 mm	1	NSB104-50
51 mm	1	NSB104-51*
52 mm	1	NSB104-52*
53 mm	1	NSB104-53*
54 mm	1	NSB104-54*
55 mm	1	NSB104-55
56 mm	1	NSB104-56*
57 mm	1	NSB104-57*
58 mm	1	NSB104-58*
59 mm	1	NSB104-59
60 mm	1	NSB104-60
61 mm	1	NSB104-61*
62 mm	1	NSB104-62*
63 mm	1	NSB104-63*
64 mm	1	NSB104-64*
65 mm	1	NSB104-65
66 mm	1	NSB104-66*
67 mm	1	NSB104-67*
68 mm	1	NSB104-68*
69 mm	1	NSB104-69*
70 mm	1	NSB104-70
71 mm	1	NSB104-71*
72 mm	1	NSB104-72*
73 mm	1	NSB104-73*
74 mm	1	NSB104-74*
75 mm	1	NSB104-75
76 mm	1	NSB104-76*

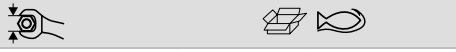

77 mm	1	NSB104-77*
78 mm	1	NSB104-78*
79 mm	1	NSB104-79*
80 mm	1	NSB104-80*
81 mm	1	NSB104-81*
82 mm	1	NSB104-82*
83 mm	1	NSB104-83*
84 mm	1	NSB104-84*
85 mm	1	NSB104-85*
86 mm	1	NSB104-86*
87 mm	1	NSB104-87*
88 mm	1	NSB104-88*
89 mm	1	NSB104-89*
90 mm	1	NSB104-90*
92 mm	1	NSB104-92*
94 mm	1	NSB104-94*
95 mm	1	NSB104-95*
98 mm	1	NSB104-98*
100 mm	1	NSB104-100*
105 mm	1	NSB104-105*
110 mm	1	NSB104-110*
115 mm	1	NSB104-115*
120 mm	1	NSB104-120*

BAM/ZBF/003/21

Non-Sparking Imperial Slogging Ring
Wrenches Aluminium Bronze



NS106

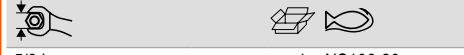

5/8 in	1	NS106-20
11/16 in	1	NS106-22*
3/4 in	1	NS106-24*
25/32 in	1	NS106-25*
13/16 in	1	NS106-26
7/8 in	1	NS106-28
15/16 in	1	NS106-30
1 in	1	NS106-32*
1 1/16 in	1	NS106-34
1 1/8 in	1	NS106-36
1 3/16 in	1	NS106-38*
1 1/4 in	1	NS106-40
1 5/16 in	1	NS106-42
1 3/8 in	1	NS106-44*
1 13/32 in	1	NS106-45*
1 7/16 in	1	NS106-46
1 1/2 in	1	NS106-48
1 9/16 in	1	NS106-50*
1 5/8 in	1	NS106-52
1 11/16 in	1	NS106-54*
1 3/4 in	1	NS106-56*
1 13/16 in	1	NS106-58
1 7/8 in	1	NS106-60
1 15/16 in	1	NS106-62*
2 in	1	NS106-64
2 1/16 in	1	NS106-66*
2 1/8 in	1	NS106-68*
2 3/16 in	1	NS106-70*
2 13/64 in	1	NS106-71*
2 1/4 in	1	NS106-72

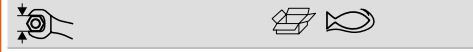

2 5/16 in	1	NS106-74*
2 3/8 in	1	NS106-76*
2 7/16 in	1	NS106-78*
2 1/2 in	1	NS106-80*
2 9/16 in	1	NS106-82*
2 5/8 in	1	NS106-84*
2 3/4 in	1	NS106-88*
2 13/16 in	1	NS106-90*
2 7/8 in	1	NS106-92*
2 15/16 in	1	NS106-94*
3 in	1	NS106-96
3 1/16 in	1	NS106-98*
3 1/8 in	1	NS106-100*
3 1/4 in	1	NS106-104*
3 3/8 in	1	NS106-108*
3 1/2 in	1	NS106-112*
3 9/16 in	1	NS106-114*
3 5/8 in	1	NS106-116*
3 3/4 in	1	NS106-120*
3 7/8 in	1	NS106-124*
3 15/16 in	1	NS106-126*
4 in	1	NS106-128*
4 1/8 in	1	NS106-132*
4 1/4 in	1	NS106-136*
4 5/16 in	1	NS106-138*
4 1/2 in	1	NS106-144*
4 9/16 in	1	NS106-146*
4 11/16 in	1	NS106-150*
4 7/8 in	1	NS106-156*
4 15/16 in	1	NS106-158*

BAM/ZBF/002/21



Non-Sparking Imperial Slogging Ring
Wrenches Copper Beryllium

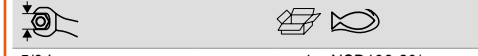

NSB106



5/8 in	1	NSB106-20*
11/16 in	1	NSB106-22
3/4 in	1	NSB106-24*
25/32 in	1	NSB106-25*
13/16 in	1	NSB106-26*
7/8 in	1	NSB106-28
15/16 in	1	NSB106-30*
1 in	1	NSB106-32*
1.1/16 in	1	NSB106-34*
1.1/8 in	1	NSB106-36*
1.3/16 in	1	NSB106-38*
1.1/4 in	1	NSB106-40*
1.5/16 in	1	NSB106-42*
1.3/8 in	1	NSB106-44*
1.13/32 in	1	NSB106-45*
1.7/16 in	1	NSB106-46
1.1/2 in	1	NSB106-48*
1.9/16 in	1	NSB106-50*
1.5/8 in	1	NSB106-52*
1.11/16 in	1	NSB106-54*
1.3/4 in	1	NSB106-56*
1.13/16 in	1	NSB106-58*
1.7/8 in	1	NSB106-60*

				
1.15/16 in	1			NSB106-62*
2 in	1			NSB106-64*
2.1/16 in	1			NSB106-66*
2.1/8 in	1			NSB106-68*
2.3/16 in	1			NSB106-70*
2.13/64 in	1			NSB106-71*
2.1/4 in	1			NSB106-72*
2.5/16 in	1			NSB106-74*
2.3/8 in	1			NSB106-76*
2.7/16 in	1			NSB106-78*
2.1/2 in	1			NSB106-80*
2.9/16 in	1			NSB106-82*
2.5/8 in	1			NSB106-84*
2.3/4 in	1			NSB106-88*
2.13/16 in	1			NSB106-90*
2.7/8 in	1			NSB106-92
2.15/16 in	1			NSB106-94*
3 in	1			NSB106-96*
3.1/16 in	1			NSB106-98*
3.1/8 in	1			NSB106-100*
3.1/4 in	1			NSB106-104*
3.3/8 in	1			NSB106-108*
3.1/2 in	1			NSB106-112*
3.9/16 in	1			NSB106-114*
3.5/8 in	1			NSB106-116*
3.3/4 in	1			NSB106-120*
3.7/8 in	1			NSB106-124*
3.15/16 in	1			NSB106-126
4 in	1			NSB106-128*
4.1/8 in	1			NSB106-132*
4.1/4 in	1			NSB106-136*
4.5/16 in	1			NSB106-138*
4.1/2 in	1			NSB106-144*
4.9/16 in	1			NSB106-146*
4.11/16 in	1			NSB106-150*
4.7/8 in	1			NSB106-156*
4.15/16 in	1			NSB106-158*





BAM/ZBF/003/21

PIPE WRENCHES & VALVE TOOLS

Non-Sparking Heavy Duty Pipe Wrenches Aluminium Bronze



NS200





			
25 mm	200 mm	1	NS200-200
30 mm	250 mm	1	NS200-250
40 mm	300 mm	1	NS200-300
50 mm	350 mm	1	NS200-350
60 mm	450 mm	1	NS200-450
75 mm	600 mm	1	NS200-600
85 mm	900 mm	1	NS200-900
110 mm	1200 mm	1	NS200-1200*

BAM/ZBF/002/21

Non-Sparking Heavy Duty Pipe Wrenches Copper Beryllium



NSB200

			
25 mm	200 mm	1	NSB200-200
30 mm	250 mm	1	NSB200-250
40 mm	300 mm	1	NSB200-300
50 mm	350 mm	1	NSB200-350
60 mm	450 mm	1	NSB200-450
75 mm	600 mm	1	NSB200-600
85 mm	900 mm	1	NSB200-900
110 mm	1200 mm	1	NSB200-1200

BAM/ZBF/003/21

Non-Sparking Long Valve Wrenches Aluminium Bronze



NS202

		
370 mm	1	NS202-350

BAM/ZBF/002/21

Non-Sparking Long Valve Wrenches Copper Beryllium



NSB202

		
375 mm	1	NSB202-350





BAM/ZBF/003/21

Non-Sparking Valve Wrenches Aluminium Bronze



NS203

			
215 mm	24 mm	1	NS203-200
215 mm	32 mm	1	NS203-215





			
290 mm	36 mm	1	NS203-290
400 mm	48 mm	1	NS203-400
490 mm	60 mm	1	NS203-490
800 mm	60 mm	1	NS203-800

BAM/ZBF/002/21

Non-Sparking Valve Wrenches Copper Beryllium



NSB203



			
215 mm	24 mm	1	NSB203-200
215 mm	32 mm	1	NSB203-215
290 mm	36 mm	1	NSB203-290
400 mm	48 mm	1	NSB203-400
490 mm	60 mm	1	NSB203-490
800 mm	60 mm	1	NSB203-800*

BAM/ZBF/003/21

Non-Sparking Valve Hooks Aluminium Bronze



NS204

		
200 mm	1	NS204-30
300 mm	1	NS204-32
250 mm	1	NS204-35
300 mm	1	NS204-40
350 mm	1	NS204-45
375 mm	1	NS204-48
400 mm	1	NS204-50
450 mm	1	NS204-55*
500 mm	1	NS204-60
550 mm	1	NS204-65
600 mm	1	NS204-70
650 mm	1	NS204-75*
700 mm	1	NS204-80
750 mm	1	NS204-85*
800 mm	1	NS204-90

BAM/ZBF/002/21

* Until stocks last



Non-Sparking Valve Hooks Copper Beryllium



NSB204

Length (L)	Part Number
200 mm	1 NSB204-30
300 mm	1 NSB204-32*
250 mm	1 NSB204-35*
300 mm	1 NSB204-40*
350 mm	1 NSB204-45*
375 mm	1 NSB204-48*
400 mm	1 NSB204-50
450 mm	1 NSB204-55*
500 mm	1 NSB204-60
550 mm	1 NSB204-65*
600 mm	1 NSB204-70*
650 mm	1 NSB204-75*
700 mm	1 NSB204-80*
750 mm	1 NSB204-85*
800 mm	1 NSB204-90

BAM/ZBF/003/21

SOCKETS & RATCHETS

Non-Sparking 1/2" Sockets with Metric Hex Profile Aluminium Bronze



NS220

Hex Size	Length (L)	Part Number
6 mm	40 mm	1 NS220-06
7 mm	40 mm	1 NS220-07
8 mm	40 mm	1 NS220-08
9 mm	40 mm	1 NS220-09
10 mm	40 mm	1 NS220-10
11 mm	40 mm	1 NS220-11
12 mm	40 mm	1 NS220-12
13 mm	40 mm	1 NS220-13
14 mm	40 mm	1 NS220-14
15 mm	40 mm	1 NS220-15
16 mm	40 mm	1 NS220-16
17 mm	40 mm	1 NS220-17

Hex Size	Length (L)	Part Number
18 mm	42 mm	1 NS220-18
19 mm	42 mm	1 NS220-19
20 mm	42 mm	1 NS220-20
21 mm	43 mm	1 NS220-21
22 mm	43 mm	1 NS220-22
23 mm	43 mm	1 NS220-23
24 mm	43 mm	1 NS220-24
25 mm	43 mm	1 NS220-25
26 mm	43 mm	1 NS220-26
27 mm	46 mm	1 NS220-27
28 mm	46 mm	1 NS220-28
29 mm	46 mm	1 NS220-29
30 mm	46 mm	1 NS220-30
32 mm	46 mm	1 NS220-32
34 mm	50 mm	1 NS220-34*
36 mm	50 mm	1 NS220-36
41 mm	55 mm	1 NS220-41

BAM/ZBF/002/21

Non-Sparking 1/2" Sockets with Metric Hex Profile Copper Beryllium



NSB220

Hex Size	Length (L)	Part Number
6 mm	40 mm	1 NSB220-06
7 mm	40 mm	1 NSB220-07
8 mm	40 mm	1 NSB220-08
9 mm	40 mm	1 NSB220-09
10 mm	40 mm	1 NSB220-10
11 mm	40 mm	1 NSB220-11
12 mm	40 mm	1 NSB220-12
13 mm	41 mm	1 NSB220-13
14 mm	40 mm	1 NSB220-14
15 mm	40 mm	1 NSB220-15
16 mm	40 mm	1 NSB220-16
17 mm	41 mm	1 NSB220-17
18 mm	42 mm	1 NSB220-18
19 mm	42 mm	1 NSB220-19
20 mm	42 mm	1 NSB220-20
21 mm	43 mm	1 NSB220-21
22 mm	43 mm	1 NSB220-22
23 mm	44 mm	1 NSB220-23
24 mm	43 mm	1 NSB220-24
25 mm	44 mm	1 NSB220-25
26 mm	43 mm	1 NSB220-26
27 mm	47 mm	1 NSB220-27
28 mm	46 mm	1 NSB220-28
29 mm	47 mm	1 NSB220-29
30 mm	46 mm	1 NSB220-30
32 mm	47 mm	1 NSB220-32

BAM/ZBF/003/21

Non-Sparking 3/4" Sockets with Metric Hex Profile Aluminium Bronze



NS224

Hex Size	Length (L)	Part Number
17 mm	50 mm	1 NS224-17
18 mm	50 mm	1 NS224-18*
19 mm	50 mm	1 NS224-19
21 mm	55 mm	1 NS224-21*
22 mm	55 mm	1 NS224-22
23 mm	55 mm	1 NS224-23
24 mm	55 mm	1 NS224-24
26 mm	55 mm	1 NS224-26*
27 mm	55 mm	1 NS224-27
28 mm	55 mm	1 NS224-28*
29 mm	55 mm	1 NS224-29
30 mm	60 mm	1 NS224-30
32 mm	60 mm	1 NS224-32
34 mm	60 mm	1 NS224-34
36 mm	60 mm	1 NS224-36
38 mm	60 mm	1 NS224-38
41 mm	65 mm	1 NS224-41
46 mm	65 mm	1 NS224-46
50 mm	70 mm	1 NS224-50

BAM/ZBF/002/21

Non-Sparking 3/4" Sockets with Metric Hex Profile Copper Beryllium



NSB224

Hex Size	Length (L)	Part Number
17 mm	50 mm	1 NSB224-17
18 mm	50 mm	1 NSB224-18*
19 mm	50 mm	1 NSB224-19
21 mm	55 mm	1 NSB224-21*
22 mm	55 mm	1 NSB224-22
23 mm	55 mm	1 NSB224-23*
24 mm	56 mm	1 NSB224-24
26 mm	55 mm	1 NSB224-26*
27 mm	55 mm	1 NSB224-27*
28 mm	55 mm	1 NSB224-28
29 mm	55 mm	1 NSB224-29*
30 mm	60 mm	1 NSB224-30
32 mm	61 mm	1 NSB224-32
34 mm	60 mm	1 NSB224-34*
36 mm	61 mm	1 NSB224-36
38 mm	60 mm	1 NSB224-38*
41 mm	66 mm	1 NSB224-41

Ø	L	Icon	Part No.
46 mm	65 mm		1 NSB224-46
50 mm	71 mm		1 NSB224-50

BAM/ZBF/003/21

Non-Sparking 1" Sockets with Metric Hex Profile Aluminium Bronze



NS228

Ø	L	Icon	Part No.
22 mm	55 mm		1 NS228-22
24 mm	55 mm		1 NS228-24
26 mm	55 mm		1 NS228-26*
27 mm	55 mm		1 NS228-27*
28 mm	55 mm		1 NS228-28*
29 mm	55 mm		1 NS228-29*
30 mm	60 mm		1 NS228-30*
31 mm	60 mm		1 NS228-31*
32 mm	60 mm		1 NS228-32
34 mm	60 mm		1 NS228-34*
36 mm	65 mm		1 NS228-36
38 mm	65 mm		1 NS228-38*
41 mm	70 mm		1 NS228-41
46 mm	75 mm		1 NS228-46
50 mm	75 mm		1 NS228-50
55 mm	80 mm		1 NS228-55
60 mm	85 mm		1 NS228-60
65 mm	90 mm		1 NS228-65
70 mm	90 mm		1 NS228-70
75 mm	95 mm		1 NS228-75*
80 mm	95 mm		1 NS228-80*

BAM/ZBF/002/21

Non-Sparking 1" Sockets with Metric Hex Profile Copper Beryllium



NSB228

Ø	g	Icon	Part No.
22 mm	370 g		1 NSB228-22*
24 mm	430 g		1 NSB228-24*
26 mm	396 g		1 NSB228-26*
27 mm	440 g		1 NSB228-27*
28 mm	411 g		1 NSB228-28*
29 mm	460 g		1 NSB228-29*
30 mm	462 g		1 NSB228-30*

Ø	g	Icon	Part No.
31 mm	520 g		1 NSB228-31*
32 mm	497 g		1 NSB228-32*
34 mm	506 g		1 NSB228-34*
36 mm	610 g		1 NSB228-36*
38 mm	600 g		1 NSB228-38*
41 mm	740 g		1 NSB228-41*
46 mm	832 g		1 NSB228-46
50 mm	960 g		1 NSB228-50
55 mm	1130 g		1 NSB228-55*
60 mm	1570 g		1 NSB228-60*
65 mm	1698 g		1 NSB228-65*
70 mm	2350 g		1 NSB228-70*
75 mm	3010 g		1 NSB228-75*
80 mm	2818 g		1 NSB228-80*

BAM/ZBF/003/21

Non-Sparking Adapters Aluminium Bronze



NS232

Ø	Ø	Icon	Part No.
1/2"	3/4"		1 NS232-16-24
3/4"	1/2"		1 NS232-24-16
3/4"	1"		1 NS232-24-32*
1"	3/4"		1 NS232-32-24

BAM/ZBF/002/21

Non-Sparking Adapters Copper Beryllium



NSB232

Ø	Ø	Icon	Part No.
1/2"	3/4"		1 NSB232-16-24
3/4"	1/2"		1 NSB232-24-16
3/4"	1"		1 NSB232-24-32
1"	3/4"		1 NSB232-32-24

BAM/ZBF/003/21

Non-Sparking Extensions Aluminium Bronze



NS234

Ø	Ø	Icon	Part No.
1/2"	1/2"		1 NS234-16-100
1/2"	1/2"		1 NS234-16-200
1/2"	1/2"		1 NS234-16-250
3/4"	3/4"		1 NS234-24-200
1"	1"		1 NS234-32-250

BAM/ZBF/002/21

Non-Sparking Extensions Copper Beryllium



NSB234

L	Ø	Icon	Part No.
100 mm	16.4 mm		1 NSB234-16-100
200 mm	16.4 mm		1 NSB234-16-200
250 mm	16.4 mm		1 NSB234-16-250
200 mm	25 mm		1 NSB234-24-200
250 mm	34 mm		1 NSB234-32-250

BAM/ZBF/003/21

Non-Sparking Universal Joints Aluminium Bronze



NS236

Ø	Ø	Icon	Part No.
1/2"	1/2"		1 NS236-16
3/4"	3/4"		1 NS236-24*
1"	1"		1 NS236-32*

BAM/ZBF/002/21

* Until stocks last



Non-Sparking Universal Joints Copper Beryllium



NSB236

□	□	□	□
1/2"	1/2"	1	NSB236-16
3/4"	3/4"	1	NSB236-24*
1"	1"	1	NSB236-32*

BAM/ZBF/003/21

Non-Sparking Offset L-handles Aluminium Bronze



NS240

□	L	□	□
1/2"	230 mm	1	NS240-16-230

BAM/ZBF/002/21

Non-Sparking Reversible Ratchets Copper Beryllium



NSB242

□	L	□	□
1/2"	245 mm	1	NSB242-16
3/4"	320 mm	1	NSB242-24
1"	550 mm	1	NSB242-32*

BAM/ZBF/003/21

Non-Sparking Sliding T-handles Aluminium Bronze



NS238

□	L	□	□
1/2"	250 mm	1	NS238-16-250
3/4"	260 mm	1	NS238-24-250
1"	300 mm	1	NS238-32-300*

BAM/ZBF/002/21

Non-Sparking Offset L-handles Copper Beryllium



NSB240

□	g	□	□
1/2"	370 g	1	NSB240-16-230*

BAM/ZBF/003/21

Non-Sparking Speed Handles Aluminium Bronze



NS243

□	L	□	□
1/2"	390 mm	1	NS243-16-400

BAM/ZBF/002/21

Non-Sparking Sliding T-handles Copper Beryllium



NSB238

□	L	□	□
1/2"	250 mm	1	NSB238-16-250
3/4"	250 mm	1	NSB238-24-250*
1"	300 mm	1	NSB238-32-300*

BAM/ZBF/003/21

Non-Sparking Reversible Ratchets Aluminium Bronze



NS242

□	L	□	□
1/2"	245 mm	1	NS242-16
3/4"	320 mm	1	NS242-24
1"	550 mm	1	NS242-32*

BAM/ZBF/002/21

Non-Sparking Speed Handles Copper Beryllium



NSB243

□	L	□	□
1/2"	395 mm	1	NSB243-16-400

BAM/ZBF/003/21

Non-Sparking Spark Plug Sockets with Hex Profile Aluminium Bronze



NS247

1/2"	13 mm	1	NS247-26*

BAM/ZBF/002/21

Non-Sparking Spark Plug Sockets with Hex Profile Copper Beryllium



NS248

1/2"	13 mm	1	NS248-26*

BAM/ZBF/003/21

Non-Sparking Screwdriver Sockets Aluminium Bronze



NS248

13 mm		1	NS248-16-52*

BAM/ZBF/002/21

Non-Sparking Screwdriver Sockets Copper Beryllium



NSB248

13 mm		1	NSB248-16-52*

BAM/ZBF/003/21

SCREWDRIVERS

ERGO™ Non-Sparking Slotted Screwdrivers Aluminium Bronze



NS300

3 mm	50 mm	1	NS300-3-50
3 mm	75 mm	1	NS300-3-75
4 mm	75 mm	1	NS300-4-75
4.5 mm	50 mm	1	NS300-4.5-50
4.5 mm	100 mm	1	NS300-4.5-100
5 mm	75 mm	1	NS300-5-75
5 mm	100 mm	1	NS300-5-100
6 mm	100 mm	1	NS300-6-100
6 mm	125 mm	1	NS300-6-125
6 mm	150 mm	1	NS300-6-150
7 mm	150 mm	1	NS300-7-150
8 mm	150 mm	1	NS300-8-150
8 mm	200 mm	1	NS300-8-200
9 mm	250 mm	1	NS300-9-250
10 mm	200 mm	1	NS300-10-200
10 mm	300 mm	1	NS300-10-300
11 mm	250 mm	1	NS300-11-250
11 mm	300 mm	1	NS300-11-300
11 mm	350 mm	1	NS300-11-350
12 mm	400 mm	1	NS300-12-400
13 mm	450 mm	1	NS300-13-450

BAM/ZBF/002/21

ERGO™ Non-Sparking Slotted Screwdrivers Copper Beryllium



NSB300

3 mm	50 mm	1	NSB300-3-50
3 mm	75 mm	1	NSB300-3-75
4 mm	75 mm	1	NSB300-4-75
4.5 mm	60 mm	1	NSB300-4.5-50
4.5 mm	95 mm	1	NSB300-4.5-100
5 mm	75 mm	1	NSB300-5-75
5 mm	100 mm	1	NSB300-5-100
6 mm	105 mm	1	NSB300-6-100
6 mm	125 mm	1	NSB300-6-125
6 mm	160 mm	1	NSB300-6-150
7 mm	150 mm	1	NSB300-7-150
8 mm	150 mm	1	NSB300-8-150
8 mm	200 mm	1	NSB300-8-200
9 mm	250 mm	1	NSB300-9-250
9 mm	200 mm	1	NSB300-10-200
10 mm	318 mm	1	NSB300-10-300
11 mm	250 mm	1	NSB300-11-250
11 mm	300 mm	1	NSB300-11-300
11 mm	350 mm	1	NSB300-11-350
12 mm	400 mm	1	NSB300-12-400
13 mm	450 mm	1	NSB300-13-450

BAM/ZBF/003/21

ERGO™ Non-Sparking Electrician Flat Tipped Screwdrivers Aluminium Bronze



NS301

3 mm	50 mm	1	NS301-3-50
4 mm	100 mm	1	NS301-4-100
4 mm	150 mm	1	NS301-4-150
5 mm	100 mm	1	NS301-5-100
5 mm	200 mm	1	NS301-5-200
6 mm	100 mm	1	NS301-6-100
8 mm	150 mm	1	NS301-8-150
10 mm	200 mm	1	NS301-10-200
10 mm	300 mm	1	NS301-10-300

BAM/ZBF/002/21

* Until stocks last



ERGO™ Non-Sparking Electrician Flat Tipped Screwdrivers Copper Beryllium



NSB301

Tip Size	Length	Material
3 mm	50 mm	1 NSB301-3-50
4 mm	100 mm	1 NSB301-4-100
4 mm	150 mm	1 NSB301-4-150
5 mm	100 mm	1 NSB301-5-100
5 mm	210 mm	1 NSB301-5-200
6 mm	100 mm	1 NSB301-6-100
8 mm	155 mm	1 NSB301-8-150
10 mm	200 mm	1 NSB301-10-200
10 mm	300 mm	1 NSB301-10-300

BAM/ZBF/003/21

ERGO™ Non-Sparking Phillips Screwdrivers Aluminium Bronze



NS302

Tip Size	Length	Material
PH0	50 mm	1 NS302-0-50
PH1	100 mm	1 NS302-1-100
PH2	125 mm	1 NS302-2-125
PH3	150 mm	1 NS302-3-150
PH4	300 mm	1 NS302-4-300

BAM/ZBF/002/21

ERGO™ Non-Sparking Phillips Screwdrivers Copper Beryllium



NSB302

Tip Size	Length	Material
PH0	65 mm	1 NSB302-0-50
PH1	120 mm	1 NSB302-1-100
PH2	125 mm	1 NSB302-2-125
PH3	150 mm	1 NSB302-3-150
PH4	300 mm	1 NSB302-4-300

BAM/ZBF/003/21

ERGO™ Non-Sparking Pozidriv Screwdrivers Aluminium Bronze



NS304

Tip Size	Length	Material
PZ0	50 mm	1 NS304-0-50
PZ1	100 mm	1 NS304-1-100
PZ2	125 mm	1 NS304-2-125
PZ3	150 mm	1 NS304-3-150
PZ4	300 mm	1 NS304-4-300

BAM/ZBF/002/21

ERGO™ Non-Sparking Pozidriv Screwdrivers Copper Beryllium



NSB304

Tip Size	Length	Material
PZ0	50 mm	1 NSB304-0-50
PZ1	100 mm	1 NSB304-1-100
PZ2	125 mm	1 NSB304-2-125
PZ3	150 mm	1 NSB304-3-150
PZ4	300 mm	1 NSB304-4-300

BAM/ZBF/003/21

Non-Sparking Offset Keys Aluminium Bronze



NS320

Tip Size	Length	Material
2 mm	59 mm	1 NS320-2
3 mm	59 mm	1 NS320-3
4 mm	65 mm	1 NS320-4
5 mm	79 mm	1 NS320-5
6 mm	85 mm	1 NS320-6
7 mm	88 mm	1 NS320-7
8 mm	92 mm	1 NS320-8
9 mm	99 mm	1 NS320-9
10 mm	110 mm	1 NS320-10

BAM/ZBF/002/21

Non-Sparking Offset Keys Copper Beryllium



NSB320

Tip Size	Length	Material
2 mm	59 mm	1 NSB320-2
3 mm	59 mm	1 NSB320-3
4 mm	65 mm	1 NSB320-4
5 mm	79 mm	1 NSB320-5
6 mm	85 mm	1 NSB320-6
7 mm	88 mm	1 NSB320-7
8 mm	93 mm	1 NSB320-8
9 mm	97 mm	1 NSB320-9
10 mm	110 mm	1 NSB320-10

BAM/ZBF/003/21

PLIERS

Non-Sparking Combination Pliers Aluminium Bronze



NS400

Length	Material
155 mm	1 NS400-160
175 mm	1 NS400-180
200 mm	1 NS400-200

BAM/ZBF/002/21

Non-Sparking Combination Pliers Copper Beryllium



NSB400

Length	Material
157 mm	1 NSB400-160
175 mm	1 NSB400-180
200 mm	1 NSB400-200

BAM/ZBF/003/21

Non-Sparking Diagonal Cutting Pliers
Aluminium Bronze



NS402

150 mm	1 NS402-160
200 mm	1 NS402-200

BAM/ZBF/002/21

Non-Sparking Diagonal Cutting Pliers
Copper Beryllium



NSB402

155 mm	1 NSB402-160
200 mm	1 NSB402-200

BAM/ZBF/003/21

Non-Sparking Heavy Duty Diagonal
Cutting Pliers Aluminium Bronze



NS403

150 mm	1 NS403-160
180 mm	1 NS403-180

BAM/ZBF/002/21

Non-Sparking Heavy Duty Diagonal
Cutting Pliers Copper Beryllium



NSB403

155 mm	1 NSB403-160
180 mm	1 NSB403-180

BAM/ZBF/003/21

Non-Sparking Long Flat Nose Pliers
Aluminium Bronze



NS404

150 mm	1 NS404-160

BAM/ZBF/002/21

Non-Sparking Long Flat Nose Pliers
Copper Beryllium



NSB404

155 mm	1 NSB404-160

BAM/ZBF/003/21

Non-Sparking Round Nose Pliers
Aluminium Bronze



NS405

160 mm	1 NS405-160

BAM/ZBF/002/21

Non-Sparking Round Nose Pliers Copper
Beryllium



NSB405

155 mm	1 NSB405-160*

BAM/ZBF/003/21

Non-Sparking Long Nose Pliers Aluminium
Bronze



NS406

160 mm	1 NS406-160
180 mm	1 NS406-180
200 mm	1 NS406-200

BAM/ZBF/002/21

Non-Sparking Long Nose Pliers Copper
Beryllium



NSB406

155 mm	1 NSB406-160
180 mm	1 NSB406-180
200 mm	1 NSB406-200

BAM/ZBF/003/21

Non-Sparking Wire Strippers Aluminium
Bronze



NS407

170 mm	1 NS407-160

BAM/ZBF/002/21

* Until stocks last



Non-Sparking Wire Strippers Copper Beryllium



NSB407



170 mm



1 NSB407-160

BAM/ZBF/003/21

Non-Sparking Groove Joint Pliers Aluminium Bronze



NS408



260 mm

300 mm



1 NS408-250

1 NS408-300

BAM/ZBF/002/21

Non-Sparking Groove Joint Pliers Copper Beryllium



NSB408



255 mm

300 mm



1 NSB408-250

1 NSB408-300

BAM/ZBF/003/21

Non-Sparking Slip Joint Pliers Aluminium Bronze



NS412



200 mm



1 NS412-200

BAM/ZBF/002/21

Non-Sparking Slip Joint Pliers Copper Beryllium



NSB412



200 mm



1 NSB412-200

BAM/ZBF/003/21

Non-Sparking Gas Pliers Aluminium Bronze



NS411



200 mm



1 NS411-200

BAM/ZBF/002/21

Non-Sparking Gas Pliers Copper Beryllium



NSB411



205 mm



1 NSB411-200

BAM/ZBF/003/21

Non-Sparking Carpenter's Pincers Aluminium Bronze



NS413



180 mm

195 mm



1 NS413-180

1 NS413-200

BAM/ZBF/002/21

Non-Sparking Carpenter's Pincers Copper Beryllium



NSB413



185 mm

195 mm



1 NSB413-180*

1 NSB413-200

BAM/ZBF/003/21

HAMMERS, PRY BARS & CHISELS

Non-Sparking Stoning Hammers with Aluminium Bronze Head and Wooden Handle



NS500



2000 g

2500 g

3000 g

4000 g



1 NS500-2000

1 NS500-2500

1 NS500-3000

1 NS500-4000

BAM/ZBF/002/21

Non-Sparking Stoning Hammers with Copper Beryllium Head and Wooden Handle



NSB500



2000 g

2500 g

3000 g

4000 g



1 NSB500-2000

1 NSB500-2500

1 NSB500-3000

1 NSB500-4000

BAM/ZBF/003/21

Non-Sparking Stoning Hammers with Aluminium Bronze Head and Fibreglass Handle



NS500-FB

1000 g	1 NS500-1000-FB
1500 g	1 NS500-1500-FB
2000 g	1 NS500-2000-FB
2500 g	1 NS500-2500-FB
3000 g	1 NS500-3000-FB
3500 g	1 NS500-3500-FB

BAM/ZBF/002/21

2500 g	1 NS502-2500-FB
3000 g	1 NS502-3000-FB
4500 g	1 NS502-4500-FB
5000 g	1 NS502-5000-FB
6800 g	1 NS502-6800-FB
8000 g	1 NS502-8000-FB
10000 g	1 NS502-10000-FB
12000 g	1 NS502-12000-FB*

BAM/ZBF/002/21

Non-Sparking Sledge Hammers with Copper Beryllium Head and Fibreglass Handle



NSB502-FB

450 g	1 NSB502-450-FB
1000 g	1 NSB502-1000-FB
1500 g	1 NSB502-1500-FB
2000 g	1 NSB502-2000-FB
2500 g	1 NSB502-2500-FB
3000 g	1 NSB502-3000-FB
4500 g	1 NSB502-4500-FB
5000 g	1 NSB502-5000-FB
6800 g	1 NSB502-6800-FB
8000 g	1 NSB502-8000-FB*
10000 g	1 NSB502-10000-FB
12000 g	1 NSB502-12000-FB

BAM/ZBF/003/21

Non-Sparking Machinist's Hammers with Aluminium Bronze Head and Fibreglass Handle



NS504-FB

100 g	1 NS504-100-FB
200 g	1 NS504-200-FB
300 g	1 NS504-300-FB
500 g	1 NS504-500-FB
800 g	1 NS504-800-FB
1000 g	1 NS504-1000-FB
1500 g	1 NS504-1500-FB
2000 g	1 NS504-2000-FB

BAM/ZBF/002/21

Non-Sparking Machinist's Hammers with Copper Beryllium Head and Fibreglass Handle



NSB504-FB

100 g	1 NSB504-100-FB
200 g	1 NSB504-200-FB
300 g	1 NSB504-300-FB
500 g	1 NSB504-500-FB
800 g	1 NSB504-800-FB
1000 g	1 NSB504-1000-FB
1500 g	1 NSB504-1500-FB
2000 g	1 NSB504-2000-FB

BAM/ZBF/003/21

Non-Sparking Ball Pein Hammers with Aluminium Bronze Head and Wooden Handle



NS506

340 g	1 NS506-300
450 g	1 NS506-450
670 g	1 NS506-700
910 g	1 NS506-900

BAM/ZBF/002/21

Non-Sparking Ball Pein Hammers with Copper Beryllium Head and Wooden Handle



NSB506

300 g	1 NSB506-300
450 g	1 NSB506-450
680 g	1 NSB506-700
910 g	1 NSB506-900

BAM/ZBF/003/21

Non-Sparking Stoning Hammers with Copper Beryllium Head and Fibreglass Handle



NSB500-FB

1000 g	1 NSB500-1000-FB
1500 g	1 NSB500-1500-FB
2000 g	1 NSB500-2000-FB
2500 g	1 NSB500-2500-FB
3000 g	1 NSB500-3000-FB
3500 g	1 NSB500-3500-FB

BAM/ZBF/003/21

Non-Sparking Sledge Hammers with Aluminium Bronze Head and Fibreglass Handle



NS502-FB

450 g	1 NS502-450-FB
1000 g	1 NS502-1000-FB
1500 g	1 NS502-1500-FB
2000 g	1 NS502-2000-FB

* Until stocks last



Non-Sparking Ball Pein Hammers with Aluminium Bronze Head and Fibreglass Handle



NS506-FB

Weight	Part Number
310 g	1 NS506-300-FB
470 g	1 NS506-450-FB
700 g	1 NS506-700-FB
910 g	1 NS506-900-FB

BAM/ZBF/002/21

Non-Sparking Ball Pein Hammers with Copper Beryllium Head and Fibreglass Handle



NSB506-FB

Weight	Part Number
300 g	1 NSB506-300-FB
450 g	1 NSB506-450-FB
680 g	1 NSB506-700-FB
900 g	1 NSB506-900-FB

BAM/ZBF/003/21

Non-Sparking Claw Hammers with Aluminium Bronze Head and Fibreglass Handle



NS508-FB

Weight	Part Number
500 g	1 NS508-500-FB
700 g	1 NS508-700-FB

BAM/ZBF/002/21

Non-Sparking Claw Hammers with Copper Beryllium Head and Fibreglass Handle



NSB508-FB

Weight	Part Number
500 g	1 NSB508-500-FB
700 g	1 NSB508-700-FB

BAM/ZBF/003/21

Non-Sparking Chipping Hammers with Aluminium Bronze Head and Fibreglass Handle



NS512-FB

Weight	Part Number
230 g	1 NS512-200-FB
400 g	1 NS512-400-FB
640 g	1 NS512-600-FB
970 g	1 NS512-900-FB

BAM/ZBF/002/21

Non-Sparking Chipping Hammers with Copper Beryllium Head and Fibreglass Handle



NSB512-FB

Weight	Part Number
200 g	1 NSB512-200-FB
400 g	1 NSB512-400-FB
600 g	1 NSB512-600-FB
900 g	1 NSB512-900-FB*

BAM/ZBF/003/21

Non-Sparking Wedges Aluminium Bronze



NS600

Length (mm)	Part Number
80 mm	1 NS600-80-13
100 mm	1 NS600-100-50
135 mm	1 NS600-135-50
150 mm	1 NS600-150-25
150 mm	1 NS600-150-30
150 mm	1 NS600-150-40
150 mm	1 NS600-150-50
180 mm	1 NS600-180-13
180 mm	1 NS600-180-32
180 mm	1 NS600-180-50
200 mm	1 NS600-200-20
200 mm	1 NS600-200-30
200 mm	1 NS600-200-40
200 mm	1 NS600-200-50
230 mm	1 NS600-230-40
250 mm	1 NS600-250-40
300 mm	1 NS600-300-50

BAM/ZBF/002/21

Non-Sparking Wedges Copper Beryllium



NSB600

Length (mm)	Part Number
80 mm	1 NSB600-80-13
100 mm	1 NSB600-100-50
135 mm	1 NSB600-135-50
150 mm	1 NSB600-150-25
150 mm	1 NSB600-150-30
150 mm	1 NSB600-150-40*
150 mm	1 NSB600-150-50
180 mm	1 NSB600-180-13*
180 mm	1 NSB600-180-32
180 mm	1 NSB600-180-50
200 mm	1 NSB600-200-20
200 mm	1 NSB600-200-30
200 mm	1 NSB600-200-40*
200 mm	1 NSB600-200-50
230 mm	1 NSB600-230-40
250 mm	1 NSB600-250-40*
300 mm	1 NSB600-300-50

BAM/ZBF/003/21

Non-Sparking Wrecking Bars Aluminium
Bronze



NS602

Ø	L	1	NS602-460
16 mm	460 mm	1	NS602-460
20 mm	600 mm	1	NS602-600
22 mm	760 mm	1	NS602-760
22 mm	935 mm	1	NS602-900

BAM/ZBF/002/21

Non-Sparking Cross Cutting Chisels
Copper Beryllium



NSB604

L	1	NSB604-150*
140 mm	1	NSB604-150*
200 mm	1	NSB604-200*
300 mm	1	NSB604-300*

BAM/ZBF/003/21

Non-Sparking Centre Punches Aluminium
Bronze



NS608

L	1	NS608-100
100 mm	1	NS608-100

BAM/ZBF/002/21

Non-Sparking Wrecking Bars Copper
Beryllium



NSB6028

Ø	L	1	NSB602-460
16 mm	460 mm	1	NSB602-460
20 mm	600 mm	1	NSB602-600
22 mm	760 mm	1	NSB602-760
22 mm	920 mm	1	NSB602-900

BAM/ZBF/003/21

Non-Sparking Flat Chisels Aluminium
Bronze



NS606

L	1	NS606-150
150 mm	1	NS606-150
200 mm	1	NS606-200
250 mm	1	NS606-250
300 mm	1	NS606-300
400 mm	1	NS606-400

BAM/ZBF/002/21

Non-Sparking Centre Punches Copper
Beryllium



NSB608

L	1	NSB608-100
100 mm	1	NSB608-100

BAM/ZBF/003/21

Non-Sparking Cross Cutting Chisels
Aluminium Bronze



NS604

L	1	NS604-150
140 mm	1	NS604-150
200 mm	1	NS604-200
300 mm	1	NS604-300

BAM/ZBF/002/21

Non-Sparking Flat Chisels Copper
Beryllium



NSB606

L	1	NSB606-150
150 mm	1	NSB606-150
200 mm	1	NSB606-200
250 mm	1	NSB606-250
300 mm	1	NSB606-300
400 mm	1	NSB606-400

BAM/ZBF/003/21

SCRAPERS

Non-Sparking Angled Scrapers Aluminium
Bronze



NS700

Ø	L	1	NS700-300
45 mm	300 mm	1	NS700-300

BAM/ZBF/002/21

* Until stocks last



Non-Sparking Angled Scrapers Copper Beryllium



NSB700

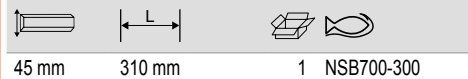

45 mm 310 mm 1 NSB700-300

BAM/ZBF/003/21

Non-Sparking Long Blade Scrapers Aluminium Bronze



NS704



100 mm 720 mm 1 NS704-225

BAM/ZBF/002/21

Non-Sparking Flexible Scrapers Copper Beryllium



NSB706



50 mm 200 mm 1 NSB706-50
80 mm 200 mm 1 NSB706-80

BAM/ZBF/003/21

Non-Sparking Flat Scrapers Aluminium Bronze



NS702



30 mm 325 mm 1 NS702-200

BAM/ZBF/002/21

Non-Sparking Long Blade Scrapers Copper Beryllium



NSB704



100 mm 720 mm 1 NSB704-225

BAM/ZBF/003/21

Non-Sparking Three-Square Scrapers Aluminium Bronze



NS708



440 mm 1 NS708-360

BAM/ZBF/002/21

Non-Sparking Flat Scrapers Copper Beryllium



NSB702



30 mm 325 mm 1 NSB702-200

BAM/ZBF/003/21

Non-Sparking Flexible Scrapers Aluminium Bronze



NS706



50 mm 200 mm 1 NS706-50
80 mm 200 mm 1 NS706-80

BAM/ZBF/002/21

Non-Sparking Three-Square Scrapers Copper Beryllium



NSB708



450 mm 1 NSB708-360

BAM/ZBF/003/21

Non-Sparking Triangular Ship Scrapers
Aluminium Bronze



NS710

470 mm	1	NS710-450

BAM/ZBF/002/21

Non-Sparking Triangular Ship Scrapers
Copper Beryllium



NSB710

470 mm	1	NSB710-450

BAM/ZBF/003/21

DIGGING TOOLS

Non-Sparking Pickaxes Aluminium Bronze



NS800

910 mm	1	NS800-1100
910 mm	1	NS800-1700
965 mm	1	NS800-2000

BAM/ZBF/002/21

Non-Sparking Pickaxes Copper Beryllium



NSB800

910 mm	2000 g	1	NSB800-1100
910 mm	2800 g	1	NSB800-1700
910 mm	3200 g	1	NSB800-2000

BAM/ZBF/003/21

Non-Sparking Round Shovels Aluminium
Bronze



NS802

1370 mm	1	NS802-290

BAM/ZBF/002/21

Non-Sparking Round Shovels Copper
Beryllium



NSB802

1450 mm	1	NSB802-290

BAM/ZBF/003/21

Non-Sparking Hand Brushes Brass



NS804

290 mm	1	NS804-290

BAM/ZBF/002/21

EXTRACTORS & PULLERS

Non-Sparking 3-Jaws Reversible Pullers
Aluminium Bronze



NS810

50-100 mm	105 mm	1	NS810-100*
60-150 mm	175 mm	1	NS810-150*
70-200 mm	250 mm	1	NS810-200*
80-350 mm	320 mm	1	NS810-350*

BAM/ZBF/002/21

Non-Sparking 3-Jaws Reversible Pullers
Copper Beryllium



NSB810

50-100 mm	105 mm	1	NSB810-100*
60-150 mm	175 mm	1	NSB810-150*
70-200 mm	250 mm	1	NSB810-200*
80-350 mm	320 mm	1	NSB810-350*

BAM/ZBF/003/21

* Until stocks last



TORQUE TOOLS

Non-Sparking Mechanical Adjustable Torque Click Wrenches with Window Scale and Fixed Ratchet Head in Aluminium Bronze



NS041

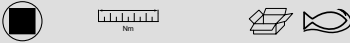

1/4"	5-25 N·m	1	NS041-8-25
3/8"	10-50 N·m	1	NS041-12-50*
1/2"	20-100 N·m	1	NS041-16-100*
1/2"	40-200 N·m	1	NS041-16-200
1/2"	60-260 N·m	1	NS041-16-260
3/4"	150-670 N·m	1	NS041-24-670*
1"	200-900 N·m	1	NS041-32-900*

BAM/ZBF/002/21

Non-Sparking Mechanical Adjustable Torque Click Wrenches with Window Scale and Fixed Ratchet Head in Copper Beryllium



NSB041

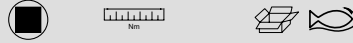

1/4"	5-25 N·m	1	NSB041-8-25
3/8"	10-50 N·m	1	NSB041-12-50
1/2"	20-100 N·m	1	NSB041-16-100*
1/2"	40-200 N·m	1	NSB041-16-200
1/2"	60-260 N·m	1	NSB041-16-260
3/4"	150-670 N·m	1	NSB041-24-670*
1"	200-900 N·m	1	NSB041-32-900*

BAM/ZBF/003/21



Stainless Steel Tools



TROLLEYS

26" 7 Drawers Stainless Steel Tool Trolley



1470K7SS



956 x 500 x 762 mm

1 1470K7SS

40" 7 Drawers Stainless Steel Tool Trolley



1475KXL7SS



986 x 501 x 1100 mm

1 1475KXL7SS

WRENCHES

Stainless Steel Central Nut Adjustable Wrenches



SS001



100mm/4"	13 mm	1	SS001-100
150mm/6"	18 mm	1	SS001-150
200mm/8"	24 mm	1	SS001-200
250mm/10"	30 mm	1	SS001-250

300mm/12"	36 mm	1	SS001-300
375mm/15"	46 mm	1	SS001-375
450mm/18"	55 mm	1	SS001-450
600mm/24"	60 mm	1	SS001-600

Stainless Steel Metric Offset Combination Wrenches



SS002



7 mm	1	SS002-7
6 mm	1	SS002-6
8 mm	1	SS002-8
10 mm	1	SS002-10
11 mm	1	SS002-11
12 mm	1	SS002-12
13 mm	1	SS002-13
14 mm	1	SS002-14
15 mm	1	SS002-15
16 mm	1	SS002-16
17 mm	1	SS002-17
19 mm	1	SS002-19
21 mm	1	SS002-21
22 mm	1	SS002-22
24 mm	1	SS002-24
27 mm	1	SS002-27
32 mm	1	SS002-32

Stainless Steel Metric Combination Wrench Set - 6 Pcs



SS002-6-2



6 710 g 1 SS002-6-2

SS002-8, SS002-10, SS002-12, SS002-14, SS002-17, SS002-19

Stainless Steel Metric Combination Wrench Set - 9 Pcs



SS002-9-2



9 924 g 1 SS002-9-2

SS002-8, SS002-10, SS002-11, SS002-12, SS002-13, SS002-14, SS002-15, SS002-17, SS002-19

Stainless Steel Imperial Combination Wrenches



SS003



1/4 in	105 mm	1	SS003-8
5/16 in	120 mm	1	SS003-10
11/32 in	135 mm	1	SS003-11
3/8 in	135 mm	1	SS003-12
7/16 in	150 mm	1	SS003-14
1/2 in	175 mm	1	SS003-16
9/16 in	175 mm	1	SS003-18
5/8 in	195 mm	1	SS003-20
11/16 in	195 mm	1	SS003-22
3/4 in	215 mm	1	SS003-24
25/32 in	215 mm	1	SS003-25
13/16 in	245 mm	1	SS003-26
7/8 in	245 mm	1	SS003-28
15/16 in	265 mm	1	SS003-30



Stainless Steel Metric Double Ring End Offset Wrenches



SS011



5.5*7 mm	180 mm	1	SS011-0507*
6*7 mm	180 mm	1	SS011-0607*
8*9 mm	190 mm	1	SS011-0809*
8*10 mm	190 mm	1	SS011-0810*

			
9*11 mm	215 mm	1	SS011-0911*
10*12 mm	215 mm	1	SS011-1012*
12*14 mm	225 mm	1	SS011-1214*
14*17 mm	255 mm	1	SS011-1417*
16*18 mm	280 mm	1	SS011-1618*
17*19 mm	280 mm	1	SS011-1719*
17*22 mm	300 mm	1	SS011-1722*
22*24 mm	330 mm	1	SS011-2224*
24*27 mm	340 mm	1	SS011-2427*
24*30 mm	350 mm	1	SS011-2430*
30*32 mm	370 mm	1	SS011-3032*

Stainless steel double ring end offset wrenches sets, mm. 9 pieces



SS011-9-3

			
9	2470 g	1	SS011-9-3*

SS011-0810, SS011-1012, SS011-1214, SS011-1417, SS011-1719, SS011-1722, SS011-2224, SS011-2427, SS011-3032

Stainless steel double ring end offset wrenches sets, mm. 11 pieces



SS011-11-3

			
11	3100 g	1	SS011-11-3*



SS011-0810, SS011-0911, SS011-1012, SS011-1214, SS011-1417, SS011-1719, SS011-1722, SS011-2224, SS011-2427, SS011-2430, SS011-3032

SOCKETS & RATCHETS

1/4" Square Drive Stainless Steel Sockets with Metric Hex Profile





SS210

			
4 mm	25 mm	1	SS210-4
4.5 mm	25 mm	1	SS210-4.5
5 mm	25 mm	1	SS210-5
5.5 mm	25 mm	1	SS210-5.5
6 mm	25 mm	1	SS210-6
7 mm	25 mm	1	SS210-7
8 mm	25 mm	1	SS210-8
9 mm	25 mm	1	SS210-9
10 mm	25 mm	1	SS210-10
11 mm	25 mm	1	SS210-11
12 mm	26 mm	1	SS210-12
13 mm	26 mm	1	SS210-13
14 mm	26 mm	1	SS210-14

1/2" Square Drive Stainless Steel Sockets with Metric Hex Profile





SS220

			
8 mm	40 mm	1	SS220-8
9 mm	40 mm	1	SS220-9
10 mm	40 mm	1	SS220-10
11 mm	40 mm	1	SS220-11
12 mm	40 mm	1	SS220-12
13 mm	40 mm	1	SS220-13
14 mm	40 mm	1	SS220-14
15 mm	40 mm	1	SS220-15
16 mm	40 mm	1	SS220-16
17 mm	40 mm	1	SS220-17
18 mm	42 mm	1	SS220-18
19 mm	42 mm	1	SS220-19
20 mm	42 mm	1	SS220-20
21 mm	43 mm	1	SS220-21
22 mm	43 mm	1	SS220-22
23 mm	43 mm	1	SS220-23
24 mm	43 mm	1	SS220-24
25 mm	43 mm	1	SS220-25
26 mm	43 mm	1	SS220-26
27 mm	46 mm	1	SS220-27
28 mm	46 mm	1	SS220-28
29 mm	46 mm	1	SS220-29
30 mm	46 mm	1	SS220-30
31 mm	46 mm	1	SS220-31
32 mm	46 mm	1	SS220-32

3/4" Square Drive Stainless Steel Sockets with Metric Hex Profile





SS224

			
17 mm	50 mm	1	SS224-17
19 mm	50 mm	1	SS224-19
22 mm	55 mm	1	SS224-22
24 mm	55 mm	1	SS224-24
27 mm	55 mm	1	SS224-27
30 mm	60 mm	1	SS224-30
32 mm	60 mm	1	SS224-32
34 mm	60 mm	1	SS224-34
36 mm	60 mm	1	SS224-36
41 mm	65 mm	1	SS224-41
46 mm	65 mm	1	SS224-46
50 mm	70 mm	1	SS224-50
55 mm	75 mm	1	SS224-55
60 mm	75 mm	1	SS224-60
65 mm	80 mm	1	SS224-65

Stainless Steel Extensions





SS234

			
100 mm	1/2"	1	SS234-16-100
200 mm	1/2"	1	SS234-16-200
250 mm	1/2"	1	SS234-16-250
100 mm	3/4"	1	SS234-24-100
200 mm	3/4"	1	SS234-24-200
250 mm	3/4"	1	SS234-24-250

Stainless Steel Universal Joints



SS236

			
56 mm	1/4"	1	SS236-08-80
80 mm	1/2"	1	SS236-16-80
110 mm	3/4"	1	SS236-24-110



Stainless Steel Sliding T-Handles



SS238

Length	Width	Part Number
250 mm	1/4"	1 SS238-08-250
250 mm	1/2"	1 SS238-16-250
350 mm	3/4"	1 SS238-24-350

Stainless Steel Rotary Speed Handles



SS243

Length	Width	Part Number
300 mm	1/4"	1 SS243-08
390 mm	1/2"	1 SS243-16
450 mm	3/4"	1 SS243-24

Stainless Steel Reversible Ratchets



SS242

Length	Width	Part Number
200 mm	1/4"	1 SS242-08-200
245 mm	1/2"	1 SS242-16-245
320 mm	3/4"	1 SS242-24-320

SCREWDRIVERS

ERGO™ Stainless Steel Straight Tipped Slotted Screwdrivers with 3-Component Handle 0.5 mm-1.2 mm



BE-8020i - BE-8252i

Tip Size	Length	Part Number
3.0 mm	60 mm	5 BE-8020I
3.5 mm	75 mm	5 BE-8030I
4.0 mm	100 mm	5 BE-8040I
5.5 mm	125 mm	5 BE-8241I
6.5 mm	150 mm	5 BE-8252I

ERGO™ Stainless Steel Phillips Screwdrivers with 3-Component Handle PH0-PH4



BE-8600i - BE-8623i

Tip Size	Length	Part Number
PH 0	60 mm	5 BE-8600I
PH 1	75 mm	5 BE-8610I
PH 2	100 mm	5 BE-8620I
PH 3	150 mm	5 BE-8623I

ERGO™ Stainless Steel Pozidriv Screwdrivers with 3-Component Handle PZ0-PZ4



BE-8800i - BE-8823i

Tip Size	Length	Part Number
PZ 0	60 mm	5 BE-8800I
PZ 1	75 mm	5 BE-8810I
PZ 2	100 mm	5 BE-8820I
PZ 3	150 mm	5 BE-8823I

ERGO™ Stainless Steel TORX® Screwdrivers with 3-Component Handle T10-T25



BE-8910i - BE-8925i

Tip Size	Length	Part Number
T 10	75 mm	5 BE-8910I
T 15	100 mm	5 BE-8915I
T 20	100 mm	5 BE-8920I
T 25	125 mm	5 BE-8925I

ERGO™ Stainless Steel Slotted/Phillips Screwdriver Set - 6 Pcs



BE-9881i

Tip Size	Length	Part Number
6		1 BE-9881I

BE-8020I, BE-8040I, BE-8241I, BE-8252I		
BE-8610I, BE-8620I		

ERGO™ Stainless Steel Slotted/Pozidriv Screwdriver Set - 6 Pcs



BE-9882i

Tip Size	Length	Part Number
6		1 BE-9882I

BE-8020I, BE-8040I, BE-8241I, BE-8252I		
BE-8810I, BE-8820I		

L-KEYS

Metric Stainless Steel L-Keys with Long Ball End for Hex Screws



SS324

Hex Size	Length	Part No.
1.5 mm	80 mm	1 SS324-1.5*
2 mm	85 mm	1 SS324-2*
2.5 mm	93 mm	1 SS324-2.5*
3 mm	103 mm	1 SS324-3*
4 mm	110 mm	1 SS324-4*
5 mm	123 mm	1 SS324-5*
6 mm	146 mm	1 SS324-6*
8 mm	168 mm	1 SS324-8*
10 mm	180 mm	1 SS324-10*

Metric Stainless Steel L-Key Set with Long Ball End for Hex Screws - 9 Pcs



BE-9770i

Hex Size	Length	Part No.
9	1.5; 2; 2.5; 3; 4; 5; 6; 8; 10 mm	20 BE-9770I

SS324-1.5, SS324-2, SS324-2.5, SS324-3, SS324-4, SS324-5, SS324-6, SS324-8, SS324-10

Imperial Stainless Steel L-Keys with Long Ball End for Hex Screws



SS325

Hex Size	Length	Part No.
5/64" in	85 mm	1 SS325-2.5*
7/64" in	96 mm	1 SS325-3.5*
1/8" in	101 mm	1 SS325-4*
9/64" in	106 mm	1 SS325-4.5*
5/32" in	111 mm	1 SS325-5*
3/16" in	121 mm	1 SS325-6*
7/32" in	132 mm	1 SS325-7*
1/4" in	142 mm	1 SS325-8*
5/16" in	163 mm	1 SS325-10*
3/8" in	183 mm	1 SS325-12*
3/32" in	90 mm	1 SS325-3*

Imperial Stainless Steel L-Key Set with Long Ball End for Hex Screws - 13 Pcs



BE-9786i

Hex Size	Length	Part No.
13	0.05; 1/16; 5/64; 3/32; 7/64; 1/8; 9/64; 5/32; 3/16; 7/32; 1/4; 5/16; 3/8; in	1 BE-9786I

SS325-2.5, SS325-3, SS325-3.5, SS325-4, SS325-4.5, SS325-5, SS325-6, SS325-7, SS325-8, SS325-10, SS325-12

SCREWDRIVER BITS

1/4" Stainless Steel Torsion Screwdriver Bits for Phillips Head Screws 25 mm



65I/PH

Hex Size	Length	Part No.
10	1	1 65I/PH1*
2	1	1 65I/PH1-2P*
2	2	1 65I/PH2-2P*
10	3	1 65I/PH3*
2	3	1 65I/PH3-2P*

1/4" Stainless Steel Torsion Screwdriver Bits for Pozidriv Head Screws 25 mm



65I/PZ

Hex Size	Length	Part No.
10	1	1 65I/PZ1*
2	1	1 65I/PZ1-2P*
2	2	1 65I/PZ2-2P*
10	3	1 65I/PZ3*
2	3	1 65I/PZ3-2P*

1/4" Stainless Steel Torsion Screwdriver Bits for TORX® Head Screws 25 mm



65I/T

Hex Size	Length	Part No.
5	T15	1 65I/T15*
5	T40	1 65I/T40*
2	T40	1 65I/T40-2P*

1/4" Hex Universal Bit Holders with Retaining Ring 75 mm



KSR753

Hex Size	Length	Part No.
1	1/4 in	1 KSR753-1P*

1/4" Stainless Steel Bit Set for Phillips/Pozidriv/TORX® Screws - 7 Pcs



65I/7

Hex Size	Length	Part No.
22 x 65 x 75 mm		1 65I/7-1*

65I/PH2

65I/PZ2

65I/T15, 65I/T20, 65I/T25, 65I/T30

* Until stocks last



PLIERS

Stainless Steel Combination Pliers with PVC Coated Handles



SS400



155 mm	1	SS400-160
175 mm	1	SS400-180
200 mm	1	SS400-200

Stainless Steel Diagonal Cutting Pliers with PVC Coated Handles



SS402



150 mm	1	SS402-160
195 mm	1	SS402-200

Stainless Steel Slip Joint Pliers with 2-Position and PVC Coated Handles



SS412



200 mm	1	SS412-200
--------	---	-----------

Stainless Steel Snipe Nose Pliers with PVC Coated Handles



SS406



150 mm	1	SS406-160
175 mm	1	SS406-200

Stainless Steel Box Joint Pliers with PVC Coated Handles



SS410



250 mm	1	SS410-250
300 mm	1	SS410-300

Stainless Steel Locking Pliers



SS415



255 mm	1	SS415-225
--------	---	-----------

HAMMERS

Stainless Steel Ball Pein Hammers with Fibreglass Handle



SS506



200 g	1	SS506-200-FB
300 g	1	SS506-300-FB
450 g	1	SS506-500-FB



680 g	1	SS506-700-FB
900 g	1	SS506-900-FB
1100 g	1	SS506-1100-FB

Stainless Steel Sledge Hammers with Fibreglass Handle



SS502



1000 g	1	SS502-1000-FB
1500 g	1	SS502-1500-FB
2000 g	1	SS502-2000-FB
2500 g	1	SS502-2500-FB
3000 g	1	SS502-3000-FB*
3600 g	1	SS502-3600-FB

PUNCHES & COLD CHISELS

Stainless Steel Tapered Pry Bars



SS603



500 mm	1	SS603-15-500
500 mm	1	SS603-19-500
500 mm	1	SS603-20-500
500 mm	1	SS603-23-500
800 mm	1	SS603-23-800
600 mm	1	SS603-25-600
1000 mm	1	SS603-30-1000

Stainless Steel 55° Flat Chisel with Oval Form



SS610



160 mm	1	SS610-16-160
200 mm	1	SS610-18-200
300 mm	1	SS610-24-300
400 mm	1	SS610-25-400
500 mm	1	SS610-30-500

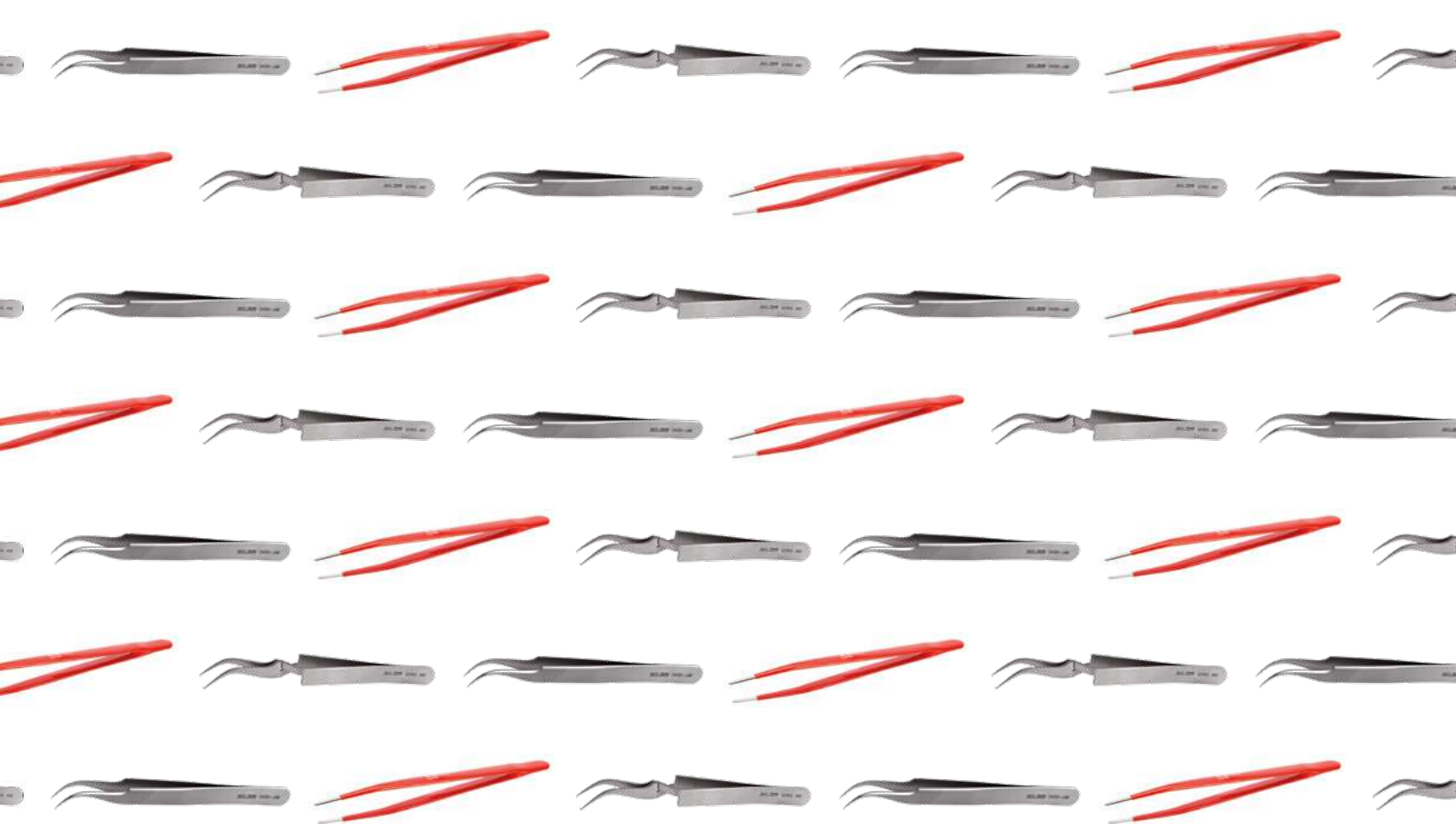

Tweezers & Electronics Specialty Tools



TWEEZERS

General Purpose Tweezers with Serrated Tips



5468



112 mm



5 5468-112

General Purpose Tweezers with Polished/PVC Coated Finish 127 mm



5469



127 mm
127 mm
127 mm



5 5469-127
5 5469 R
5 5469 I

General Purpose Tweezers with Polished/PVC Coated Finish 120 mm



5469B



120 mm
120 mm



5 5469 B
5 5469 BI

General Purpose Tweezers with Polished and Nickel Plated/Polished/PVC Coated Finish



5471F



120 mm
145 mm
200 mm



5 5471 F-120
5 5471 F-145
5 5471 F-200



250 mm
300 mm
120 mm
200 mm
120 mm
145 mm

5 5471 F-250
5 5471 F-300
5 5471 FI-120
5 5471 FI-200
5 5471 FR-120
5 5471 FR-145

General Purpose Tweezers with Polished and Nickel Plated/Polished Finish



5475R/5475K



150 mm
100 mm



5 5475 R
5 5475 K

General Purpose Tweezers with Polished and Nickel Plated/PVC Coated Finish



5516



150 mm
150 mm



5 5516
5 5516 I

Non-Magnetic Titanium General Tweezers for Fine and Ultra-Fine Assembly Work 110 mm



5465AMT



110 mm



5 5465 AMT

General Pointed Tweezers with Polished and Nickel Plated/PVC Coated Finish



5517



155 mm
155 mm



5 5517
5 5517 I

General Reverse Action Tweezers with Polished and Nickel Plated Finish



5518



155 mm



5 5518

SMD Tweezers for Handling and Positioning SOT Packages



5540AM



120 mm



5 5540 AM

SMD Tweezers for Positioning All SOT Packages Vertically



5541AM



120 mm



5 5541 AM

SMD Tweezers for Handling and Positioning 2/3 Lead SOT Packages at 45° Angle



5544AM



115 mm



5 5544 AM

SMD Tweezers for Positioning 5 mm Monolithic Chip Capacitors



5549AM



120 mm



5 5549 AM

Assembly Tweezers for Inserting and Desoldering Horizontal Components



5579



115 mm



5 5579-115

SMD Tweezers for Positioning Flat Devices at 60° Angle



5545AM



120 mm



5 5545 AM

Electronics Tweezers for Holding Smallest Components



5488AM



115 mm



5 5488 AM

SMD Tweezers for Positioning 5 mm Monolithic Chip at 60° Angle



5588AM



120 mm



5 5588 AM

SMD Tweezers for Positioning and Soldering 1 mm Components



5546AM



120 mm



5 5546 AM

Electronics Tweezers for Easy Manipulation of Components in Confined Areas



5490AM



115 mm



5 5490 AM

SMD Tweezers with Grooved Tips and 30° Bent Angle



5589AM



120 mm



5 5589 AM

SMD Tweezers for Positioning and Soldering 1 mm Components at 45° Angle



5547AM



120 mm



5 5547 AM

Assembly Tweezers for Inserting and Desoldering Horizontal Components with 4 mm Jaw



5578



122 mm



5 5578-115

SMD Tweezers for Vertical Positioning of Cylindrical Devices Ø1 mm or More



5590AM



120 mm



5 5590 AM



Watchmaker's Straight Tweezers with Polished Finish 120 mm



5463



120 mm	5	5463-120
120 mm	5	5463 R

Cutting Tweezers for Copper Wires



5493



115 mm	5	5493-115
--------	---	----------

Soldering Tweezers with Vulcanised Fibre Hand Protection



5476H



160 mm	5	5476 H
--------	---	--------

SOLDERING TOOLS

Instant Heat Double Insulated Soldering Guns



3250



100 W	400 °C	1	325001000
		1	3250010SH

3250010SH: Spare tip

Heavy-Duty Soldering Irons with Euro Plug and Soldering Stand 30 W/40 W/80 W



322500



30 W	370 °C	1	322500300
40 W	375 °C	1	322500500
80 W	380 °C	1	322500800

Electronic Soldering Irons with Euro Plug and Earth Connection 18 W/25 W



32600



18 W	390 °C	1	326000200
25 W	420 °C	1	326000300

Temperature Controlled Soldering Irons with Euro Plug and Soldering Stand



3270



50 W	200-500 °C	1	327020500
------	------------	---	-----------

Spare Tips for Heavy-Duty Soldering Iron with Straight and Angled Version



3225



1.5 x 2.5 mm	1	322510300
2 x 3 mm	1	322510500
2 x 3 mm	1	322510600
2.5 x 5 mm	1	322510700
2.5 x 5 mm	1	322510800

Spare Tips for Electronic Soldering Guns



326010



5 g	1	326010200
5 g	1	326020200
5 g	1	326030200

Spare Tips for 3270 Temperature Controlled Soldering Irons



327020500-SH

0,5mm	1	327020500-SH1
2mm	1	327020500-SH2
3mm	1	327020500-SH3
4mm	1	327020500-SH4

Long Awls/Hooks/Picks Tool Set - 4 Pcs



2633L/

12 x 12 x 275 mm	12	2633L/S4

ERGO™ O-Ring Levers for Desoldering



ergo™



BE-3529

197 mm	5	BE-3529

Lead-Free Solders 0.8 mm



3290

2000 mm	1	329000330
4000 mm	1	329000500

Double End Wires and Spring Hooks with Knurled Hexagon Handle



5418

145 mm	1	5418

Adjusting Screwdrivers with Guide Sleeve and Plastic Handle



5550

140 mm	10	5550-3.2
140 mm	10	5550-4.5

FINE MECHANICAL

Miniature Awls/Hooks/Picks Tool Set - 4 Pcs



2633/

17 x 80 x 150 mm	12	2633/S4

Hook Set 105 mm - 6 Pcs



5419/6T

5 x 78 x 110 mm	1	5419/6T

Tuning and Trimming Tools



5551-5554

205 mm	1	5552*
195 mm	1	5553*
180 mm	1	5554*

* Until stocks last



Tuning and Trimming Tools Set



5600/4



1 5600/4*

75 g

5551, 5552, 5553, 5554

Lacquer Stripping Tweezers with Plastic Grips



2530-32/2530-40



5 2530-40

130 mm

3-Square Scrapers with Nickel Plated Handle



3524



1 3524
1 3524L-K

24 g
5 g

3-Square Machinist's Scrapers with Plastic Handle



3525HB



5 3525HB

168 mm

Carbon Scrapers with Plastic Handle



2487



12 2487

210 mm



Measuring & Layout



MEASURING TAPES

Double-Sided Measuring Tapes with Rubber Grip



MTS			
L	W	Q	Model
5 m	25 mm	6	MTS-5-25
5 m	25 mm	6	MTS-5-25-E
8 m	25 mm	6	MTS-8-25
8 m	25 mm	6	MTS-8-25-E

Short Measuring Tapes with Rubber Grip



MTB			
L	W	Q	Model
3 m	16 mm	6	MTB-3-16
3 m	16 mm	6	MTB-3-16-M
3 m	16 mm	6	MTB-3-16-M-E
5 m	25 mm	6	MTB-5-25
5 m	25 mm	6	MTB-5-25-M
5 m	25 mm	6	MTB-5-25-M-E
8 m	25 mm	6	MTB-8-25
8 m	25 mm	6	MTB-8-25-M
8 m	25 mm	6	MTB-8-25-M-E

Short Measuring Tapes with Rubber Grip Class-I



MTB_C1			
L	W	Q	Model
5 m	25 mm	6	MTB-5-25-C1

Short Measuring Tapes with Positive Locking Button



MTG			
L	W	Q	Model
3 m	16 mm	12	MTG-3-16
3 m	16 mm	12	MTG-3-16-E
5 m	19 mm	12	MTG-5-19
5 m	19 mm	12	MTG-5-19-E
8 m	25 mm	4	MTG-8-25
8 m	25 mm	4	MTG-8-25-E

Short Measuring Tapes with ABS Grip Compact Class-I



MTC_C1			
L	W	Q	Model
3 m	13 mm	6	MTC-3-13-C1
5 m	16 mm	6	MTC-5-16-C1

Short Measuring Tapes with ABS Grip Compact Class-II



MTC_C2			
L	W	Q	Model
3 m	13 mm	6	MTC-3-13
5 m	16 mm	6	MTC-5-16

COMPACT 3 M x 13 mm METRIC MEASURING TAPE



MT-TS-3			
L	W	Q	Model
3 m	13 mm	12	MT-TS-3

Short Measuring Tapes with Steel Blade



1162N			
L	W	Q	Model
3 m	13 mm	1	1162N-1/2

Adhesive Steel Bench Measuring Tapes



BT			
L	W	Q	Model
3 m	13 mm	12	BTR-3-13
6 m	13 mm	12	BTR-6-13
3 m	13 mm	12	BTL-3-13
6 m	13 mm	12	BTL-6-13

Long Measuring Tapes with Steel Blade



LTG

Length (m)	Blade Width (mm)	Quantity	Model
10 m	10 mm	6	LTG-10
20 m	10 mm	6	LTG-20
30 m	10 mm	6	LTG-30

Long Measuring Tapes with Nylon Coated Blade and Open Case



LTS

Length (m)	Blade Width (mm)	Quantity	Model
30 m	13 mm	5	LTS-30
30 m	13 mm	5	LTS-30-E
50 m	13 mm	5	LTS-50
50 m	13 mm	5	LTS-50-E
100 m	13 mm	5	LTS-100
100 m	13 mm	5	LTS-100-E

Long Measuring Tapes with Nylon Coated Blade



LTB

Length (m)	Blade Width (mm)	Quantity	Model
10 m	13 mm	6	LTB-10
20 m	13 mm	6	LTB-20
30 m	13 mm	6	LTB-30

MEASURING WHEELS

Metric Rubber Coated Measuring Wheels 150 mm



MW-150

Length (mm)	Quantity	Model
150 mm	2	MW-150

Long Measuring Tapes with Steel Blade and Open Case



LT-STEEL

Length (m)	Blade Width (mm)	Quantity	Model
30 m	13 mm	5	LT-STEEL-30
50 m	13 mm	5	LT-STEEL-50

Metric Rubber Coated Measuring Wheels 250 mm



MW-250

Length (mm)	Quantity	Model
940 mm	2	MW-250

SPIRIT LEVELS

Thick Shaped Aluminium Profile Spirit Levels



466

Length (mm)	Quantity	Model
400 mm	4	466-400
400 mm	4	466-400-M
600 mm	4	466-600
600 mm	4	466-600-M
800 mm	4	466-800
800 mm	4	466-800-M
1000 mm	4	466-1000
1000 mm	4	466-1000-M
1200 mm	4	466-1200
1200 mm	4	466-1200-M
1800 mm	4	466-1800
2000 mm	4	466-2000

Rectangular Aluminium Profile Spirit Levels



426

Length (mm)	Profile	Quantity	Model
400 mm	49x22 mm	1	426-400
600 mm	49x22 mm	1	426-600
800 mm	49x22 mm	1	426-800
1000 mm	49x22 mm	1	426-1000
1200 mm	49x22 mm	1	426-1200

400 mm and 600 mm with 2 vials. 600 mm to 1200 mm with 3 vials



Light Aluminium Spirit Levels



416

Length	Quantity	Part Number
400 mm	10	416-400
600 mm	10	416-600
800 mm	10	416-800
1000 mm	10	416-1000
1200 mm	10	416-1200
1500 mm	10	416-1500
1800 mm	10	416-1800
2000 mm	10	416-2000

Lightweight Level made from solid injected aluminium



405L

Length	Quantity	Part Number
400 mm	10	405L-400
600 mm	10	405L-600

Solid Injected Aluminium Magnetic Spirit Levels



406_M

Length	Quantity	Part Number
300 mm	1	5 406-300-M
400 mm	1	5 406-400-M
500 mm	1	5 406-500-M
600 mm	1	5 406-600-M

Level made from solid injected aluminium



405

Length	Quantity	Part Number
400 mm	5	405-400
600 mm	5	405-600
800 mm	10	405-800
1000 mm	5	405-1000

Lightweight Magnetic Level made from solid injected aluminium



405L_M

Length	Quantity	Part Number
400 mm	5	405L-400-M
600 mm	5	405L-600-M

Polystyrene Spirit Levels



406P

Length	Quantity	Part Number
400 mm	10	406P-400
600 mm	10	406P-600

Magnetic Level, Solid Injected Aluminium



405_M

Length	Quantity	Part Number
400 mm	5	405-400-M
600 mm	5	405-600-M
800 mm	5	405-800-M
1000 mm	5	405-1000-M

Solid Injected Aluminium Spirit Levels



406

Length	Quantity	Part Number
300 mm	1	406-300
400 mm	5	406-400
500 mm	5	406-500
600 mm	5	406-600
800 mm	5	406-800

Spirit Level Set 600/1200/1800 mm - 3 Pcs/Carry Bag



416-SET+BAG

Quantity	Part Number
3	1 416-SET+BAG

416-SET-1

4750-LV-1

BAHCO



Spirit Level Set 600/1200/1800 mm - 3 Pcs



416-SET-1



3

5 416-SET-1

416-600, 416-1200, 416-1800



Spirit Level Set 600/1200/2000 mm - 3 Pcs



416-SET-2



3

5 416-SET-2

416-600, 416-1200, 416-2000



Magnetic Plastic Spirit Torpedo Levels



406T-225



228 mm

10 406T-225

DISP is a counter display with 12 units

Aluminium Spirit Torpedo Levels



426TOR9



230 mm

10 426TOR9

Aluminium Spirit Scaffold Levels



466-250



250 mm

10 466-250

Aluminium Spirit Line Levels 75 mm



466-LINE



75 mm

12 466-LINE

Flat Surface 2-Way Spirit Levels



466-BE1



20 g

13 x 45 x 60 mm

12 466-BE1

Magnetic Spirit Levels for Fence Post



466-POST



120 x 75 x 80 mm

6 466-POST

Aluminium Straight Edge Spirit Levels



486



1800 mm

5 486-1800

2000 mm

5 486-2000

2400 mm

5 486-2400

Aluminium Straight Edge Spirit Levels Unhandled



486-xxxWH



1800 mm

5 486-1800WH

2000 mm

5 486-2000WH

2400 mm

5 486-2400WH

Double T-Profile Spirit Precision Levels



496



1500 mm

5 496-1500

1800 mm

5 496-1800



Spare Vial for 496 Levels



496-SPARE

496-1500, 496-1800 1 496-SPARE

MARKING

Chalk Lines 5x Rewind



CL-1441

185 mm 36 CL-1441

Chalk Lines 1x Rewind



CL-1331

185 mm 48 CL-1331

Chalk Lines 3x Rewind



CL-1221

130 mm 6 CL-1221

Marking Chalk 227 g/Pour Bottle



CHALK

227 g 6 CHALK-BLUE
 227 g 6 CHALK-WHITE
 227 g 6 CHALK-RED
 227 g 6 CHALK-YELLOW

Chalk Line Set 1x Rewind - 2 Pcs



CL-1441-SET

605 g 16 CL-1441-SET

CL-1441
 CHALK-BLUE

Chalk Line Set 3x Rewind - 3 Pcs



CL-1221-SET

180 g 4 CL-1221-SET

CHALK-BLUE
 466-LINE
 CL-1221

Plumb Bobs with 5 m Cord



PBS

5 m 6 PBS-700

Plumb Bobs with Hardened Steel Tip



PBB

185 mm 227 g 8 PBB-8

HB Grade Pencils - 25 Pcs/Box



P-HB

175 mm	25	25	P-HB

FSC Certificate Code: QMI-COC-001417 File No.: 1627439

HB Grade Pencils - 200 Pcs/Display



PENCIL-200

180 mm	200	1	PENCIL-200-DISP

HB Grade Pencils



P-MEC

150 mm	1	24	P-MEC
100 mm	5	12	P-MEC-LEAD

Scribers with Interchangeable Carbide Point



1179-SCRIBE

150 mm		5	1179-SCRIBE
		1	1179-TIPS

Tungsten Carbide Scribers



1178-SCRIBE

150 mm		5	1178-SCRIBE

High Performance Alloy Steel Offset Scribers



1177-SCRIBE

230 mm		5	1177-SCRIBE

10-Section Wooden Folding Rules 2 m



WR2

2 m	17 mm	25	WR2
2 m	17 mm	25	WR2-MM

Wooden Folding Rules with 12 Section 2 m



WR2-12

2 m	17 mm	25	WR2-12

Metric and Imperial Flexible Stainless Steel Rulers



1179-FLX

160 mm	12 mm	25	1179-FLX

RULES

5-Section Wooden Folding Rules 1 m



WR1

1 m	17 mm	50	WR1
1 m	17 mm	50	WR1-MM



Metric Stainless Steel Rulers



SR_MM

L	W	QTY	Part No.
150 mm	19 mm	12	SR150-MM
200 mm	19 mm	12	SR200-MM
300 mm	25 mm	12	SR300-MM
600 mm	30 mm	20	SR600-MM
1000 mm	35 mm	20	SR1000-MM

Imperial Stainless Steel Rulers



SR_IN

L	W	QTY	Part No.
6 in	6 in	12	SR150-E
8 in	8 in	12	SR200-E
12 in	12 in	12	SR300-E
24 in	24 in	20	SR600-E
39 in	40 in	20	SR1000-E

SQUARES

Carpenter Squares with Steel Blade



9045-B

L	W	QTY	Part No.
220 mm	170 mm	6	9045-B-200
250 mm	170 mm	6	9045-B-250
300 mm	170 mm	6	9045-B-300
400 mm	170 mm	1	9045-B-400

Carpenter Squares with Stainless Steel Blade and Sliding Marker



9048

L	W	QTY	Part No.
200 mm	165 mm	10	9048-200
250 mm	165 mm	10	9048-250

L	W	QTY	Part No.
300 mm	180 mm	10	9048-300
350 mm	180 mm	10	9048-350
400 mm	180 mm	10	9048-400

Construction Squares for Layout and Setting Up



3085

L	W	QTY	Part No.
400 mm	200 mm	1	308504000
500 mm	250 mm	1	308505000
600 mm	300 mm	1	308506000
800 mm	400 mm	1	308508000
1000 mm	500 mm	1	308510000

Sliding Combination Squares with Metal Scriber



CS

L	W	QTY	Part No.
152 mm	90 mm	12	CS150
305 mm	125 mm	12	CS300
407 mm	125 mm	12	CS400

Spare parts, 4 pcs set.

Spare parts Kit for CS Model Sliding Squares - 4 Pcs



CS-SPARE

QTY	Part No.
1	CS-SPARE

Sliding Bevel Squares with Cold-Rolled Steel Blade



9572

L	W	QTY	Part No.
235 mm	115 mm	20	9572-200
250 mm	150 mm	20	9572-250

Bevel Squares with Steel Blade



9574

L	W	QTY	Part No.
215 mm	165 mm	10	9574-200
285 mm	170 mm	10	9574-250
300 mm	170 mm	10	9574-300

Fixed Bevel Squares with Stainless Steel Blade



9575

L	W	QTY	Part No.
250 mm	110 mm	6	9575-250

Flat Carpenter Squares with Steel Blade



FCS-600/FCS-1000

600 mm	300 mm	6	FCS-600
800 mm	300 mm	6	FCS-800
1000 mm	360 mm	6	FCS-1000

Mechanical Callipers



1150

150 mm	9 x 75 x 235 mm	1	1150-1/2H/P

Professional Feeler Gauges with 20 Blades



1547

20	100 mm	20	1547

0,05 mm steps Carbon steel

Adjustable Precision Squares



AS-1200

1265 mm	560 mm	3	AS-1200

Professional Feeler Gauges with 26 Blades



1544

26	100 mm	1	1544

0,03 mm to 0,1 mm in 0,01 mm increments / 0,10 mm to 1,0 mm in 0,05 mm increments

Screw Pitch Gauges with Metric 60°



1535

24	67 mm	1	1535

Stainless steel

PRECISION MEASURING

Precision Measuring Digital Callipers with LCD Screen



1150D

150 mm	25 x 90 x 245 mm	1	1150D

Professional Feeler Gauges with 13 Blades



1546

100 mm		1	1546

(0,05-0,30) x 0,05mm (0,30-1,00) x 0,10 mm Carbon steel

Screw Pitch Gauges with Metric 60° and Whitworth 55°



1537

0,25-6,0 / 4-62	70 mm	1	1537

0,25-6,00 mm, 4 to 62 TPI Stainless steel





BAHCO®



Wall Tools



SCRAPERS

ERGO™ Precision Paint Scrapers with Dual-Component Handle



ergo



625



25 mm



5 625

Replacement Blades for 625 ERGO™ Scrapers



449



25 mm



10 449

Replacement Blades for 625 ERGO™ Scrapers



625-



3 g

3 g

3 g



10 625-DROP

10 625-PEAR

10 625-ROUND

ERGO™ Universal Paint Scrapers with Dual-Component Handle



ergo



650



50 mm



5 650

Replacement Blades for 650 ERGO™ Scrapers



442



50 mm

50 mm



10 442-3P

10 442

442-3P: set of 3 blades of 442

Replacement Blades for 650 and 665 ERGO™ Scrapers



850 / 865



50 mm

65 mm



10 850-1

10 865-1

ERGO™ Heavy Duty Paint Scrapers with Dual-Component Handle



ergo



665



65 mm



5 665

Replacement Blades for 665 ERGO™ Scrapers



451



65 mm



10 451

ERGO™ Paint Scrapers Set with Dual-Component Handle



ergo



SCRAPER-SET2



50 x 145 x 265 mm



1 SCRAPER-SET2

625

625-DROP, 625-PEAR, 625-ROUND

650



Cabinet Scrapers with Plastic Edge Protector



474

Blade Width	Blade Length	Quantity	Product Code
130 mm	10	10	474-125-0.60
130 mm	10	10	474-125-0.80
150 mm	10	10	474-150-0.60
150 mm	10	10	474-150-0.80

Paint Scrapers with Carbon Steel Blade and Wooden Handle



2155

Blade Width	Blade Length	Quantity	Product Code
30 mm	195 mm	12	215500300
40 mm	195 mm	12	215500400
50 mm	195 mm	12	215500500
60 mm	215 mm	12	215500600
70 mm	220 mm	12	215500700
80 mm	225 mm	12	215500800
90 mm	230 mm	12	215500900
100 mm	234 mm	12	215501000

Paint Scrapers with Carbon Steel Blade and Plastic Handle



216

Blade Width	Blade Length	Quantity	Product Code
30 mm	210 mm	12	216000300
40 mm	210 mm	12	216000400
50 mm	210 mm	12	216000500
60 mm	210 mm	12	216000600
70 mm	210 mm	12	216000700
80 mm	210 mm	12	216000800
90 mm	228 mm	12	216000900
100 mm	230 mm	12	216001000
120 mm	230 mm	12	216001200

Paint Scrapers with Carbon Steel Blade and Dual-Component Handle



2150

Blade Width	Blade Length	Quantity	Product Code
30 mm	225 mm	12	215000030
40 mm	225 mm	12	215000040
50 mm	225 mm	12	215000050
60 mm	225 mm	12	215000060
70 mm	225 mm	12	215000070
80 mm	225 mm	12	215000080
90 mm	220 mm	12	215000090
100 mm	220 mm	12	215000100
120 mm	220 mm	12	215000120

Paint Scrapers with Stainless Steel Blade and Dual-Component Handle



2161

Blade Width	Blade Length	Quantity	Product Code
40 mm	215 mm	12	216100040
60 mm	215 mm	12	216100060
80 mm	215 mm	12	216100080
100 mm	235 mm	12	216100100
120 mm	235 mm	12	216100120

Paint Scrapers with Rigid Blade and Plastic Handle



2165

Blade Width	Blade Length	Quantity	Product Code
30 mm	180 mm	12	216500300
50 mm	180 mm	12	216500500
75 mm	200 mm	12	216500750
100 mm	200 mm	12	216501000

Filling Scrapers with Carbon Steel Blade and Wooden Handle



2190

Blade Width	Blade Length	Quantity	Product Code
100 mm	235 mm	5	219001000
120 mm	230 mm	5	219001200
140 mm	245 mm	5	219001400
160 mm	235 mm	5	219001600
200 mm	245 mm	5	219002000

Filling Scrapers with Stainless Steel Blade and Wooden Handle



2192

Blade Width	Blade Length	Quantity	Product Code
100 mm	235 mm	5	219201000
120 mm	230 mm	5	219201200
140 mm	235 mm	5	219201400
160 mm	245 mm	5	219201600
200 mm	235 mm	5	219202000

Filling Scrapers with Reinforced Stainless Steel Blade and Wooden Handle



2193

Blade Width	Quantity	Product Code
250 mm	10	219302500
300 mm	10	219303000
350 mm	10	219303500



Glue Comb Scrapers with Triangular Teeth



2212

Blade Width	Blade Length	Quantity	Product Code
130 mm	120 mm	5	221201200
130 mm	200 mm	5	221202000
130 mm	300 mm	5	221203000

Putty Knives with Stainless Steel Blade and Dual-Component Handle



2489

Blade Length	Quantity	Product Code
235 mm	12	2489

Plastering Trowels with Triangle Serrated Teeth Carbon Steel Blade and Wooden Handle



209

Blade Width	Blade Length	Quantity	Product Code
270 mm	115 mm	12	209027040

Glue Comb Scrapers with Square Teeth



2213

Blade Width	Blade Length	Quantity	Product Code
130 mm	120 mm	5	221301200
130 mm	200 mm	5	221302000
130 mm	300 mm	5	221303000

Masonry Trowels with Sharp Tipped Blade and Wooden Handle



2308

Blade Width	Blade Length	Quantity	Product Code
150 mm	100 mm	6	2308B0000*

Plastering Trowels with Square Serrated Teeth Carbon Steel Blade and Wooden Handle



2092

Blade Width	Blade Length	Quantity	Product Code
275 mm	115 mm	12	209227060
280 mm	130 mm	12	209228100
500 mm	130 mm	6	209250100

Hook Knives with Stainless Steel Blade and Dual-Component Handle



2488

Blade Length	Quantity	Product Code
230 mm	12	2488

Plastering Trowels with Carbon Steel Blade and Wooden Handle



204

Blade Width	Blade Length	Quantity	Product Code
300 mm	150 mm	12	204030150
300 mm	160 mm	12	204030160
300 mm	180 mm	12	204030180

Plastering Trowels with Stainless Steel Blade and Long Poplar Wooden Handle



2045

Blade Width	Blade Length	Quantity	Product Code
300 mm	140 mm	12	204530140
500 mm	130 mm	6	204550130

Plastering Trowels with Stainless Steel Blade and Light Poplar Wooden Handle



2045A

140 mm	300 mm	12	2045A3000

Notched Base Plastering Trowels with Polystyrene Handle



213

265 mm	140 mm	5	213026140

Flat Plasterer's Rails with Wooden Handle



2145xxxL

45 x 20 x 275 mm	1	2145020L0
45 x 25 x 275 mm	1	2145025L0
45 x 30 x 275 mm	1	2145030L0
45 x 35 x 275 mm	1	2145035L0

Plastering Trowels with Plastic Blade and Polystyrene Handle



211

350 mm	180 mm	5	211035180
420 mm	210 mm	5	211042210

Aluminium Plastering Scribes with Long Handle



2127

90 mm	435 mm	6	212704350

Curved Plasterer's Rails with Wooden Handle



2145xxxC

45 x 25 x 225 mm	1	2145025C0
45 x 35 x 210 mm	1	2145039C0

Plastering Trowels with Notched Base and Polystyrene Handle



2120

270 mm	180 mm	5	212027180
330 mm	220 mm	8	212033220

Flat and Serrated Plasterer's Rails with Wooden Handle



2145xxxD

45 x 20 x 275 mm	1	2145020D0
45 x 25 x 275 mm	1	2145025D0
45 x 30 x 275 mm	1	2145030D0
45 x 35 x 275 mm	1	2145035D0

Joints Plastering Trowels with Anti-Shock Polystyrene Handle



2122

250 mm	100 mm	10	212202500	



Sponge Base Plastering Trowels with Anti-Shock Polystyrene Handle and Hanging Clip



2123



140 mm 280 mm 10 212302900

Hard Rubber Grout Float Plastering Trowels with Anti-Shock Polystyrene Handle



2125

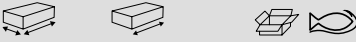

220 mm 135 mm 10 212502150

Soft Rubber Grout Float Plastering Trowels with Anti-Shock Polystyrene Handle



2126

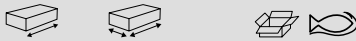

140 mm 220 mm 10 212602150
140 mm 280 mm 1 212602800

DRYWALL TOOLS

Lift Spare Set with 2 Springs and Brakes



250400010



80 g 1 250400010

Board Filter Cable



250400020



180 g 1 250400020

Board Filter Parts Set



250400030



80 g 1 250400030

Setting Tools for Metal Anchors



250501800



185 mm 50 250501800

Trim Cutters with Variable Angle



8640



230 mm 50 864002450

Spare Blades for 8640 Trim Cutter



864000010



20 g 1 864000010

Spare Mitres for 864 Trim Cutter



864000020



20 g



1 864000020

Punching Tools for Dry Lining Walls



671002600



260 mm



50 671002600*



Adjustable Trim Cutters



8641



245 mm



1 864102400



Punching Tools with Articulated Head for Dry Lining Walls



671002850



295 mm



1 671002850*



Spare Blades for 8641 Trim Cutter



864100010



5 g



1 864100010

* Until stocks last





BAHCO®



Hand Hacksaws



HAND HACKSAW FRAMES

ERGO™ Professional Hand Hacksaw Frames 300 mm



ergo



325

300 mm	5	325

Professional Hand Hacksaw Frames with Aluminium Handle 300 mm



225-PLUS

300 mm	5	225-PLUS

Professional Hand Hacksaw Frames with Soft Grip Handle 300 mm



319

300 mm	5	319

Hand Hacksaw Frames 432 mm



317

432 mm	10	317

Compact Hand Hacksaw Frames 470 mm



306

440 mm	10	306

Traditional Hand Hacksaw Frames 504 mm



320

504 mm	10	320

Traditional Hand Hacksaw Frames 517 mm



304

517 mm	10	304

Mini Hacksaws with Sandflex® Bi-Metal Blade



208

330 mm	5	208

Compass Saws 8 Blade Positions



321

330 g	5	321

Compass Saws 4 Blade Positions



210

360 g	10	210

Junior Hacksaws with Steel Frame and Fibreglass Handle 150 mm



268



150 mm



5 268

Junior Hacksaws with Steel Wire Frame and Handle 290 mm



239



260 mm



150 239

Junior High-Arch Hacksaws with Steel Profile Frame and Wooden Handle 150 mm



238



150 mm



60 238

Junior Hacksaws with Steel Profile Frame and Wooden Handle 150 mm



228



150 mm

150 mm



80 228

5 228-BULK

Junior Hacksaws with Steel Wire Frame and Wooden Handle 291 mm



219



291 mm



120 219

Junior Hacksaws with Steel Wire Frame and Handle 235 mm



218



235 mm

235 mm



10 218

150 218-BULK

HAND HACKSAW BLADES

Sandflex® Bi-Metal Spiro Hand Hacksaw Blades



3806-SPIRO



600 mm



32



10 3806-600-32

Sandflex® Bi-Metal Hand Hacksaw Blades



3906



250 mm

250 mm

250 mm

300 mm

300 mm

300 mm

300 mm

300 mm

300 mm

300 mm

300 mm

300 mm

250 mm

250 mm

250 mm

300 mm

300 mm

300 mm

300 mm

300 mm

300 mm

300 mm



18

24

32

14

18

24

32

18-28

14

18

24

32

18

24

32

14

18

24

32

18-28

18/24/32

18

24

32



100	3906-250-18-100
100	3906-250-24-100
100	3906-250-32-100
100	3906-300-14-100
100	3906-300-18-100
100	3906-300-24-100
100	3906-300-32-100
100	3818-300-PROG-100
10	3906-300-14-10P
10	3906-300-18-10P
10	3906-300-24-10P
10	3906-300-32-10P
10	3906-250-18-5P
10	3906-250-24-5P
10	3906-250-32-5P
10	3906-300-14-5P
10	3906-300-18-5P
10	3906-300-24-5P
10	3906-300-32-5P
10	3818-300-PROG-5P
10	3906-300-3P
10	3906-300-18-2P
10	3906-300-24-2P
10	3906-300-32-2P



Sandcut® High Speed Steel Hand Hacksaw Blades



3905

L	T	Q	Part No.
250 mm	24	100	3905-250-24-100
300 mm	14	100	3905-300-14-100
300 mm	18	100	3905-300-18-100
300 mm	24	100	3905-300-24-100
300 mm	32	100	3905-300-32-100
300 mm	24	10	3905-300-24-2P

Junior Hacksaw Spare Blades



228-P

L	T	Q	Part No.
150 mm	15	10	228-15-5P
150 mm	32	10	228-32-5P
150 mm	32	10	228-32-10P
150 mm	32	1	228-32-100P

Tungsten Carbide Grit Hand Hacksaw Blade



3816

L	T	Q	Part No.
300 mm	12	50	3816-300

Junior Hacksaw Rod Blades 150-300 mm



216-R

L	T	Q	Part No.
150 mm	20	1	216-150-R
300 mm	20	1	216-300-R

Junior Hacksaw Rod Blades 150 mm



215

L	T	Q	Part No.
150 mm	110	1	215-150

Sandflex® Interchangeable Compass Hand Hacksaw Blades



321-SB

L	T	Q	Part No.
310 mm	7	10	321-7-SB
310 mm	18	10	321-18-SB
310 mm	24	10	321-24-SB



Handsaws



HANDSAWS FOR CONSTRUCTION MATERIAL

ProfCut™ Toolbox General Purpose Handsaws



PC-GNP



375 mm 15/16 4 PC-15-GNP

Superior™ General Purpose Sawblades, Used with ERGO™ EX Handles



EX-16-GNP-C



400 mm 15/16 10 EX-16-GNP-C

Superior™ Compass Saws for Wood/Plastic



3150



300 mm 9/10 4 3150-12-XT9-HP

PrizeCut™ Compass Saws for Wood/Plastic



NP-COM

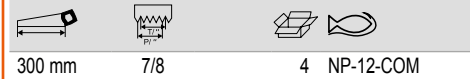

300 mm 7/8 4 NP-12-COM

ProfCut™ Compass Saws for Wood/Plastic



PC-COM



300 mm 9/10 4 PC-12-COM

Compass Saws for Plaster/Drywall/Boards of Wood Based Materials



PC-6-DRY



160 mm 8 6 PC-6-DRY

ProfCut™ Handsaws for Plaster/Boards of Wood Based Materials



PC-PLS



600 mm 7/8 4 PC-24-PLS

Superior™ Sawblades for Plaster and Boards, Used with ERGO™ EX Handles



EX-22-PLS-C

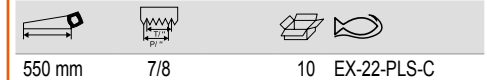

550 mm 7/8 10 EX-22-PLS-C

ProfCut™ Handsaws for Hard Plastic Tubes/Profiles



PC-22-PLC



550 mm 11/12 4 PC-22-PLC

ProfCut™ Handsaws for Polystyrene/
Stucco Profiles/Foams



PC-DECO

400 mm	18/19	4	PC-16-DECO

ProfCut™ Handsaws for Lightweight
Concrete/Leca®/Bricks



256

650 mm	2	4	256-26

General Purpose Handsaws for Plastics/
Laminates/Wood/Soft Metals



300

350 mm	15/16	4	300-14-F15/16-HP

ProfCut™ Handsaws for Lightweight
Concrete/Leca®/Bricks 1.3 TPI



255-34

620 mm	1,3	2	255-34

Insulation Saws for Mineral Wool/Stone
Wool/Eco Wool/Styrex®



PC-22-INS

550 mm	WT	4	PC-22-INS

General Purpose Spare Sawblades



369

360 mm	13/14	20	369-BLADE

ProfCut™ Handsaws for Lightweight
Concrete/Leca®/Bricks 0.6 TPI



255-17/34

620 mm	0.6	2	255-17/34

Folding Saw Specifically for Cutting
Insulation Wool Material



396-INS

190 mm	WT	10	396-INS

PrizeCut™ Universal Handsaws for
Plastics/Laminates/Wood/Soft Metals



NP

400 mm	7/8	4	NP-16-U7/8-HP
475 mm	7/8	10	NP-19-U7/8-HP
550 mm	7/8	10	NP-22-U7/8-HP

HANDSAWS FOR WOOD



PrizeCut™ Sawblades for Fine to Medium Thick Materials, Used with ERGO™ EX Handles



EX-NPP-22

550 mm	7/8	10	EX-NPP-22

PrizeCut™ Sawblades for All Types of Wood, Used with ERGO™ EX Handles



EX-22-U7

550 mm	7/8	10	EX-22-U7

ERGO™ Superior™ Toolbox Saws for Plaster/Boards of Wood Based Materials



2600-16

400 mm	11/12	4	2600-16-XT11-HP

Superior™ Sawblades for Medium to Thick Material, Used with ERGO™ EX Handles



EX-XT9

475 mm	9/10	10	EX-19-XT9-C
550 mm	9/10	10	EX-22-XT9-C

ProfCut™ Hardpoint Handsaws for Plaster/Boards of Wood Based Materials



PC-GT7

475 mm	7/8	4	PC-19-GT7
550 mm	7/8	4	PC-22-GT7

ERGO™ Superior Tenon Saws for Plastics/Laminates/Wood/Soft Metals



3180

350 mm	11/12	4	3180-14-XT11-HP

PrizeCut™ Crosscut Handsaws for Coarse/Medium Thick Wood Materials



NP-FLEEM

550 mm	7	10	NP-22-F7/8-HP

Fileable Universal Handsaws for Plastics/Laminates/Wood/Soft Metals



PC-FILE

400 mm	7/8	4	PC-16-FILE-U7
475 mm	7/8	4	PC-19-FILE-U7
550 mm	7/8	4	PC-22-FILE-U7
600 mm	7/8	4	PC-24-FILE-U7

ERGO™ Superior™ Veneer Handsaws for Plywood and Plastic



3240

350 mm	11/12	4	3240-14-XT11-HP

ERGO™ Superior™ Saws for Plaster/
Boards of Wood Based Materials



2600

475 mm	9/10	4	2600-19-XT-HP
550 mm	9/10	4	2600-22-XT-HP



Handsaws for Plastics/Laminates/Wood/
Soft Metals



244

500 mm	7/8	10	244-20-U7/8-HP
550 mm	7/8	10	244-22-U7/8-HP



Superior™ Sawblades for Fine to Medium
Thick Materials, Used with ERGO™ EX
Handles



EX-20-XT11-C

500 mm	11/12	10	EX-20-XT11-C



Hardpoint Handsaws for Plastics/
Laminates/Wood/Soft Metals



2500 XT

400 mm	11/12	4	2500-16-XT-HP
475 mm	9/10	4	2500-19-XT-HP
550 mm	9/10	4	2500-22-XT-HP
600 mm	7/8	4	2500-24-XT7-HP



Superior™ Sawblades for Laminates and
Wooden Floors, Used with ERGO™ EX
Handles



EX-20-LAM-C

500 mm	11/12	10	EX-20-LAM-C



Superior™ Tenon Sawblades for Plastics,
Laminates, Wood and Soft Metals, Used
with ERGO™ EX Handles



EX-14-TEN-C

350 mm	11/12	5	EX-14-TEN-C



ProfCut™ Laminator Saws for Laminate/
Wooden Floors



PC-LAM

500 mm	11/12	4	PC-20-LAM



ERGO™ Superior™ Saws for Plastics/
Laminates/Wood/Soft Metals



3090

500 mm	11/12	4	3090-20-XT11-HP



ERGO™ Superior™ Laminator Saws for
Laminate/Wooden Floors



SUP-LAM

500 mm	11/12	4	SUP-20-LAM



Superior™ Veneer Sawblades for
Plywood/Plastic, Used with ERGO™ EX
Handles



EX-14-VEN-C

350 mm	11/12	10	EX-14-VEN-C



ProfCut™ Hardpoint Handsaws for Hard Wood/Plywood/Thin Profile



PC-GT9

475 mm	9/10	4	PC-19-GT9
550 mm	9/10	4	PC-22-GT9

PrizeCut™ Hardpoint Sawblades for Fine/Medium Thick Material



PC-VEN

300 mm	11/12	4	PC-12-VEN

PrizeCut™ Veneer Saws for Fine/Medium Thick Material



NP-VEN

300 mm	13/14	10	NP-12-VEN

ProfCut™ Toolbox Handsaws for Fine to Medium Thick Materials



PC-TBX

375 mm	11/12	4	PC-15-TBX

ProfCut™ Sawblades for Fine/Medium Thick Material



PC-PRC

500 mm	9/10	4	PC-20-PRC

Superior™ Sawblades for Coarse/Thick Material, Used with ERGO™ EX Handles



EX-XT7

550 mm	7/8	10	EX-22-XT7-C
600 mm	7/8	10	EX-24-XT7-C

ProfCut™ Tenon Handsaws for Medium Thick Materials



PC-TEN

300 mm	11/12	4	PC-12-TEN

PrizeCut™ Tenon Saws for Fine/Medium Thick Material



NP-TEN

300 mm	13/14	10	NP-12-TEN

Barracuda Sawblades for Medium to Thick Materials, Used with ERGO™ EX Handles



EX-244P-22

550 mm	7/8	10	EX-244P-22

Handsaws with Dual-Component for Medium to Thick Wood



244P

500 mm	7/8	4	244P-20-U7-HP
550 mm	7/8	10	244P-22-U7-HP



Wooden Mitre Boxes with Optional Side Wall



233

65 x 135 x 300 mm	5	233-300
75 x 135 x 300 mm	5	233-300-A
65 x 135 x 400 mm	5	233-400



PRECISION HANDSAWS

ProfCut™ General Carpentry Pull-Saws for Wood and Plastic



PC-12-PS

305 mm	13.5	4	PC-12-14-PS
305 mm	13.5	10	PC-12-14-PS-B



ERGO™ Superior Handsaws for Timber/Wet/Tanalised Wood



2700

550 mm	7/8	4	2700-22-XT7-HP
600 mm	7/8	4	2700-24-XT7-HP



Laminated Wood Mitre Boxes



234-W

53 x 77 x 245 mm	10	234-W1
63 x 95 x 300 mm	10	234-W2
80 x 100 x 300 mm	10	234-W3



ProfCut™ Tenon Pull-Saws for Wood and Plastic



PC-11-PS

270 mm	18.5	4	PC-11-19-PS
270 mm	18.5	10	PC-11-19-PS-B



ProfCut™ Timber Saws for Timber/Wet/Tanalised Wood



PC-TIM

600 mm	3.5/4.5	4	PC-24-TIM



Aluminium Mitre Boxes



234-A

55 x 65 x 245 mm	1	234-A1
40 x 106 x 245 mm	1	234-A2



ProfCut™ Double Edge Pull-Saws for Wood and Plastic



PC-9-PS

240 mm	6-8.5 / 17	4	PC-9-9/17-PS
240 mm	6-8.5 / 17	10	PC-9-9/17-PS-B



ProfCut™ Dovetail Saws with Angled Swinging Wooden Handle



PC-DTF

250 mm	15/16	10	PC-10-DTF



ProfCut™ Dovetail Saws with Straight Wooden Handle



PC-DTR

250 mm	15/16	10	PC-10-DTR



ProfCut™ Dovetail Saws with Angled Wooden Handle



PC-DTL

250 mm	15/16	10	PC-10-DTL



HANDLES & SHARPENERS

ERGO™ BHS Handle for EX Sawblade Large



EX-

120 x 330 x 60 mm	4	EX-LL
120 x 330 x 60 mm	4	EX-RM
120 x 330 x 60 mm	4	EX-RL



Fret Saws with Frame and Wooden Handle



502

130 mm	25	502



Professional High Speed Steel Sharpeners



SHARP-INS

206 mm	100	SHARP-INS



Fret Saw Sets, 2 pieces



502-SET2

2	130 g	35	502-SET2



FRET SAWS & SAWBLADES

Fret Saws with Wooden Handle



302

130 mm	30	302



Fret Saw Sets, 6 pieces



502-SET6

6	500 g	10	502-SET6

Assortment of Spare Blades for 302 and 502 Fret Saws



302-6X4P



130 mm



1 302-6X4P

Fret Saw Spare Blades for Wood and Plastic



302W



1	130 mm	1	302-51W-12P
3	130 mm	1	302-53W-12P
5	130 mm	1	302-55W-12P
7	130 mm	1	302-57W-12P
9	130 mm	1	302-59W-12P
11	130 mm	1	302-511W-12P

MUSICAL SAW

Musical Handsaws with Wooden Handle



296



750 mm



1 296

Fret Saw Spare Blades for Metal



302M



1	130 mm	1	302-71M-12P
3	130 mm	1	302-73M-12P
5	130 mm	1	302-75M-12P
7	130 mm	1	302-77M-12P

COPING SAWS & SAWBLADES

Coping Saws with Wooden Handle



301



165 mm



50 301

Fret Saw Spiral Spare Blades for Wood and Plastic



302S



1	130 mm	1	302-81S-12P
3	130 mm	1	302-83S-12P
5	130 mm	1	302-85S-12P

Coping Sawblades for 301 Saw

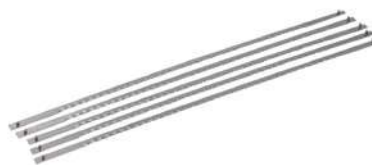

303



165 mm



10 303-5P



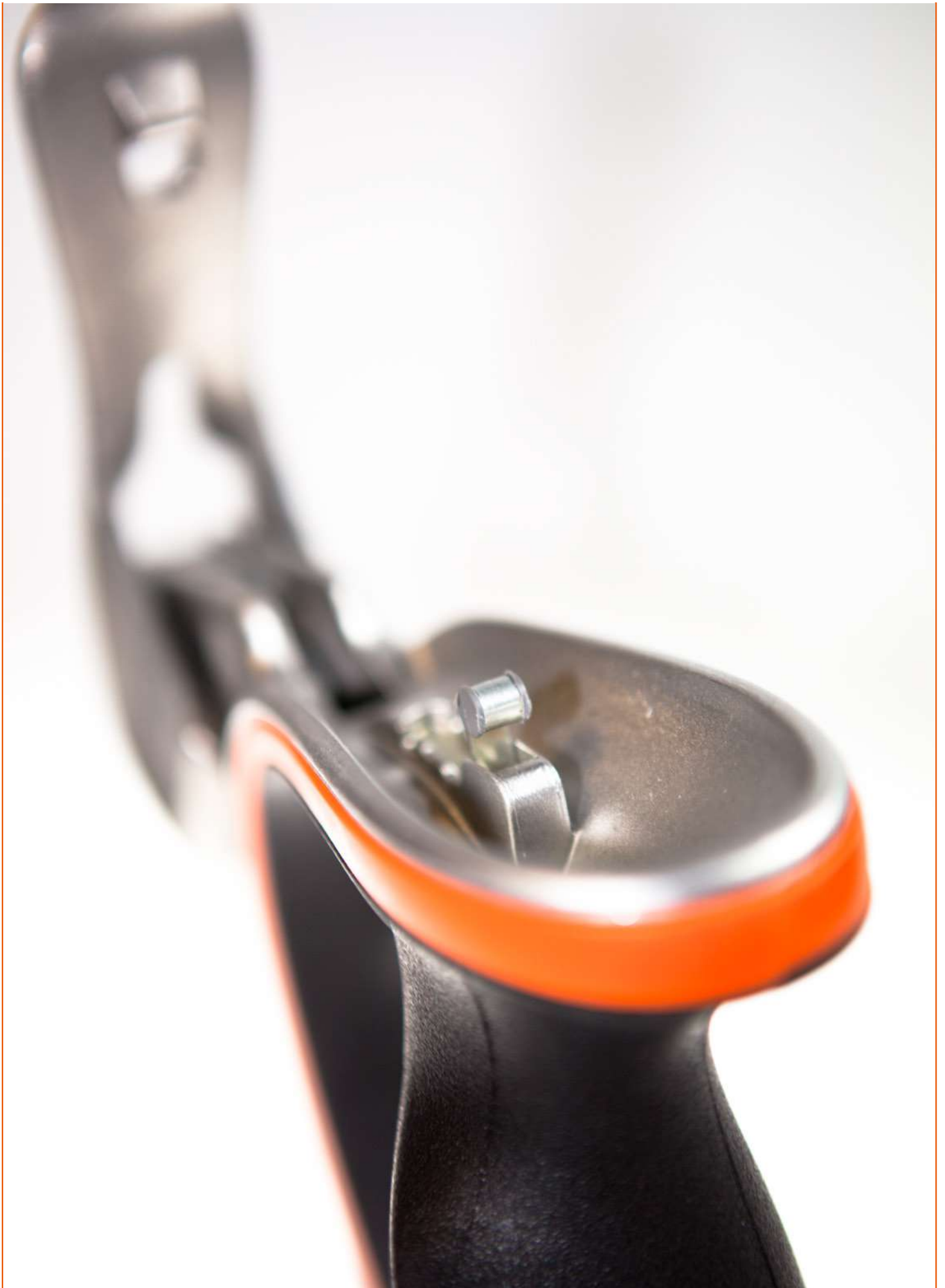

BAHCO®



Wood Chisels



WOODWORKING CHISELS

ERGO™ Splitproof Woodworking Chisels



ergo



434

Icon	Icon	
6 mm	4	434-6
8 mm	4	434-8
10 mm	4	434-10
12 mm	4	434-12
14 mm	4	434-14
15 mm	4	434-15
16 mm	4	434-16
18 mm	4	434-18
20 mm	4	434-20
22 mm	4	434-22
25 mm	4	434-25
28 mm	4	434-28
30 mm	4	434-30
32 mm	4	434-32
35 mm	4	434-35
38 mm	4	434-38
50 mm	4	434-50

Suitable for an intensive use with a metallic hammer

ERGO™ Splitproof Chisel Set - 3 Pcs/
Cardboard Box



ergo



434-S3-EUR

Icon	Icon	
3	1	434-S3-EUR

Suitable for an intensive use with a metallic hammer

434-12, 434-18, 434-25

6 pcs ERGO™ Splitproof chisel set in
leather roll pouch.



ergo



434-S6-LR

Icon	Icon	
6	1	434-S6-LR

Suitable for an intensive use with a metallic hammer

434-6, 434-10, 434-12, 434-18, 434-25, 434-32

ERGO™ Splitproof Chisel Set - 6 Pcs/
Wooden Box



ergo



434-S6-EUR

Icon	Icon	
6	1	434-S6-EUR

Suitable for an intensive use with a metallic hammer

434-6, 434-10, 434-12, 434-18, 434-25, 434-32

ERGO™ Splitproof Chisel Set - 8 Pcs/
Wooden Box



ergo



434-S8-EUR

Icon	Icon	
8	1	434-S8-EUR

Suitable for an intensive use with a metallic hammer

434-6, 434-10, 434-12, 434-16, 434-18, 434-25, 434-32, 434-38

ERGO™ Splitproof Chisel Set - 6 Pcs/
Polyester Pouch



ergo



434-S6-PP

Icon	Icon	
6	1	434-S6-PP

Suitable for an intensive use with a metallic hammer

434-6, 434-10, 434-12, 434-18, 434-25, 434-32

Woodworking Chisels with Rubberised
Handle



424P

Icon	Icon	
4 mm	4	424P-4
6 mm	4	424P-6
8 mm	4	424P-8
10 mm	4	424P-10
12 mm	4	424P-12
14 mm	4	424P-14
15 mm	4	424P-15
16 mm	4	424P-16
18 mm	4	424P-18
20 mm	4	424P-20
22 mm	4	424P-22
24 mm	4	424P-24
25 mm	4	424P-25
26 mm	4	424P-26
28 mm	4	424P-28
30 mm	4	424P-30
32 mm	4	424P-32
35 mm	4	424P-35
38 mm	4	424P-38
40 mm	4	424P-40

Chisel Set with Rubberised Handle - 3
Pcs/Cardboard Box



424P-S3-EUR

Icon	Icon	
3	1	424P-S3-EUR

424P-12, 424P-18, 424P-25

Chisel Set with Rubberised Handle 6-32
mm - 6 Pcs/Leather Roll Pouch



424P-S6-LR

Icon	Icon	
6	1	424P-S6-LR

424P-6, 424P-10, 424P-12, 424P-18, 424P-25, 424P-32

Chisel Set with Rubberised Handle - 6 Pcs/Wooden Box



424P-S6-EUR



6 1 424P-S6-EUR

424P-6, 424P-10, 424P-12, 424P-18, 424P-25, 424P-32



Chisel Set with Rubberised Handle - 6 Pcs/Wooden Box



424P-S6-GER



6 1 424P-S6-GER

424P-6, 424P-10, 424P-12, 424P-16, 424P-20, 424P-26



Chisel Set with Rubberised Handle - 8 Pcs/Wooden Box



424P-S8-EUR



8 1 424P-S8-EUR

424P-6, 424P-10, 424P-12, 424P-16, 424P-18, 424P-25, 424P-32, 424P-38



Chisel Set with Rubberised Handle - 6 Pcs/Polyester Pouch



424P-S6-PP



6 1 424P-S6-PP

424P-6, 424P-10, 424P-12, 424P-18, 424P-25, 424P-32



Woodworking Chisels with Orange Polypropylene Handle



414



6 mm	4	414-6
8 mm	4	414-8
10 mm	4	414-10
12 mm	4	414-12
14 mm	4	414-14
15 mm	4	414-15
16 mm	4	414-16
18 mm	4	414-18
20 mm	4	414-20
22 mm	4	414-22
25 mm	4	414-25
28 mm	4	414-28
30 mm	4	414-30
32 mm	4	414-32
35 mm	4	414-35
38 mm	4	414-38

Woodworking Chisels with Red Polypropylene Handle



1031



4 mm	5	1031-4
6 mm	5	1031-6
8 mm	5	1031-8



10 mm	5	1031-10
12 mm	5	1031-12
14 mm	5	1031-14
16 mm	5	1031-16
18 mm	5	1031-18
20 mm	5	1031-20
22 mm	5	1031-22
25 mm	5	1031-25
28 mm	5	1031-28
30 mm	5	1031-30
32 mm	5	1031-32
40 mm	5	1031-40

Chisel Set with Polypropylene Handle - 3 Pcs/Cardboard Box



414-S3-EUR



3 1 414-S3-EUR

414-12, 414-18, 414-25



Chisel Set with Polypropylene Handle - 5 Pcs/Blister



9883



5 1 9883

1031-6, 1031-12, 1031-16, 1031-20, 1031-25



Woodworking Chisels with Wooden Handle



425

Icon	Icon	
4 mm	4	425-4
6 mm	4	425-6
8 mm	4	425-8
10 mm	4	425-10
12 mm	4	425-12
14 mm	4	425-14
15 mm	4	425-15
16 mm	4	425-16
18 mm	4	425-18
20 mm	4	425-20
22 mm	4	425-22
24 mm	4	425-24
25 mm	4	425-25
26 mm	4	425-26
28 mm	4	425-28
30 mm	4	425-30
32 mm	4	425-32
35 mm	4	425-35
38 mm	4	425-38
40 mm	4	425-40

3 pcs wooden-handle chisel set in cardboard box



425-081

Icon	Icon	Icon
3	1	425-081

425-12, 425-18, 425-25



Chisel Set with Wooden Handle - 5 Pcs/
Cardboard Box



425-082

Icon	Icon	Icon
5	1	425-082

425-6, 425-10, 425-12, 425-18, 425-25



Chisel Set with Wooden Handle - 6 Pcs/
Wooden Box



425-083

Icon	Icon	Icon
6	1	425-083

425-6, 425-10, 425-12, 425-18, 425-25, 425-32



Spare Handles for 1031 Chisels



956

Icon	Icon	Icon
108 mm	50 g	1 956

GOUGE CHISELS

Gouge Chisels with Rubberised Handle



422P

Icon	Icon	Icon
6 mm	4	422P-6
10 mm	4	422P-10
12 mm	4	422P-12
16 mm	4	422P-16
20 mm	4	422P-20
25 mm	4	422P-25

DEMOLITION CHISELS

Heavy Duty Wrecking Knives with
Rubberised Handle



2448

Icon	Icon	Icon	Icon
25 mm	231 mm	12	2448
25 mm	240 mm	12	SB-2448

Heavy Duty Wrecking Knives with Curved
Blade and Rubberised Handle



2449

Icon	Icon	Icon	Icon
25 mm	235 mm	12	2449
25 mm	235 mm	10	SB-2449

WOOD CHISEL ACCESSORIES

Natural Grinding Stones



528-700



150 mm



1 528-700

Sharpening block



SBC110



30 x 65 x 110 mm



67 g



1 SBC110-65

Grinding Stones with Two Grains



528-COM



150 mm



1 528-COM

Block Plane Spare Blade



BP-40-95



112 mm



55 g



12 BP-40-95

Grinding Plain



BP-40



160 mm



1 BP-40

Protective Plastic Holsters



WC-HOL



292 mm



1 WC-HOL





BAHCO®



Scissors & Knives



METAL SHEARS

Straight Cut Aviation Shears with Increased Power by Lever Action and Yellow Colour Coded Handle up to 1.5 mm



MA421



250 mm 10 MA421

Multipurpose Long Straight Cut Aviation/Compound Shears with Orange Handle



MA431



290 mm 1 MA431

8698M0250: Spare parts set

Right Cut Aviation Shears with Increased Power by Lever Action and Green Colour Coded Handle up to 1.5 mm



MA411



250 mm 10 MA411

8698M0250: Spare parts set

Right Cut Aviation Shears with Increased Power by Lever Action and Green Colour Coded Handle up to 1.8 mm



MA321



260 mm 10 MA321

8697M0260: Spare parts set

Left Cut Aviation Shears with Increased Power by Lever Action and Red Colour Coded Handle up to 1.5 mm



MA401



250 mm 10 MA401

8698M0250: Spare parts set

Left Cut Aviation Shears with Increased Power by Lever Action and Red Colour Coded Handle up to 1.8 mm



MA311



260 mm 1 MA311

8697M0260: Spare parts set

Right Cut Aviation Shears with Increased Power by Lever Action



MA225R



250 mm 4 MA225R

Right Cut Pass-Through Shears with Increased Power by Lever Action and Green Colour Coded Handle



MA361



260 mm 10 MA361

8697M0260: Spare parts set

Left Cut Pass-Through Shears with Increased Power by Lever Action and Red Colour Coded Handle



MA351



250 mm 10 MA351

8697M0260: Spare parts set

Left and Straight Cut Traditional/Industrial Metal Shears with Two Thin Blades



M227L



270 mm



4 M227L

Straight Cut Traditional/Industrial Metal Shears with Two Thick Blades



M526



260 mm



4 M526

Straight Cut Two Hand Compound Shears



M676



760 mm



1 M676-SH*

Right and Straight Cut Traditional/Industrial Metal Shears with Two Thin Blades



M227R



270 mm



4 M227R

Left and Straight Cut Traditional/Industrial Metal Shears with Two Thin Blades and Return Spring



MR227L



270 mm



4 MR227L

SCISSORS

Heavy Duty Electrician Scissors



SCB140



43 mm



140 mm



10 SCB140

Long Straight Cut Pass-Through Traditional/Industrial Shears



M330



11 3/4 mm



4 M330

Straight Cut Pass-Through Two Hand Compound Shears



M6376



760 mm



1 M6376-SH

Heavy Duty Electrician Scissors with Groove



SCB140G



43 mm



140 mm



10 SCB140G

* Until stocks last



Electrician Scissors with Optional Serrated Blade



SC127/SC127S

45 mm	130 mm	10	SC127
45 mm	127 mm	10	SC127S

Special Tin Snips with Curved Cutting Jaws



2704

110 mm	1	2704A

ERGO™ Fixed Utility Knives



KEFU-01

170 mm	26 mm	5	KEFU-01

Electrician Scissors with Optional Curved Blade



SC140/SC140C

50 mm	145 mm	10	SC140
50 mm	145 mm	10	SC140C

Special Tin Forceps with Finely Serrated Jaws



2705R

160 mm	1	2705R

ERGO™ Snap Off Utility Knives with 18 mm Blades



KE18-01

161 mm	26 mm	5	KE18-01

Electrician Scissors with Longer Handle



SC150NG

38 mm	155 mm	10	SC150NG

KNIVES

ERGO™ Retractable Utility Knives



KERU01

170 mm	26 mm	5	KERU-01

Retractable Utility Knives with TPR Grip



KBRU-01

170 mm	26 mm	5	KBRU-01

Retractable Utility Knives



KGRU-01

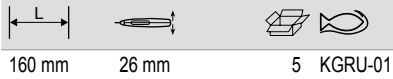

160 mm 26 mm 5 KGRU-01

Squeeze Retractable Utility Knives with Rubber Grip



SQZ150003

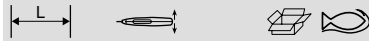

170 mm 60 mm 6 SQZ150003

Trapezoidal Blades for Utility Knives - 100 Pcs



KBGU

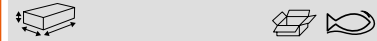

0.635 x 19 x 60 mm 1 KBGU-100P

Retractable Twist Utility Knives



KGRU-02

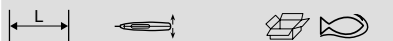

145 mm 26 mm 5 KGRU-02

Fixed Utility Knives with TPR grip



KBFU-01

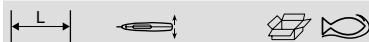

170 mm 26 mm 5 KBFU-01

Trapezoidal Blades for Utility Knives - 5 Pcs/Dispenser



KBGU-5P-DISPEN

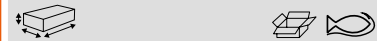

0.635 x 19 x 60 mm 20 KBGU-5P-DISPEN

Mini Retractable Utility Knives



KMU-01



90 mm 26 mm 5 KMU-01

Fixed Utility Knives



KGFU-01

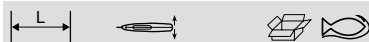

160 mm 26 mm 5 KGFU-01

Trapezoidal Blades for Utility Knives - 10 Pcs/Dispenser



KBGU-10P-DISPEN



0.635 x 19 x 60 mm 20 KBGU-10P-DISPEN



Hook Trapezoidal Blades for Utility Knives
- 5 Pcs/Dispenser



KBGH-5P-DISPEN



0.635 x 19 x 51 mm

20 KBGH-5P-DISPEN

Safety Trapezoidal Blades for Utility Knives
- 5 Pcs/Dispenser



KBGR-5P-DISPEN



0.635 x 19 x 55 mm

20 KBGR-5P-DISPEN

Trapezoidal Hook Blades for SQZ150003
Utility Knives



SQZ150003-HSBL



51 mm

6 SQZ150003-HSBL*

Snap Off Utility Knives with TPR Grip and
9 mm Blades



KB09-01



140 mm



5 KB09-01

Snap Off Utility Knives with TPR Grip and
18 mm Blades



KB18-01



160 mm



5 KB18-01

Snap Off Utility Knives with 9 mm Blades



KG09-01



140 mm



5 KG09-01

140 mm 10 KG09-01-3P

Snap Off Utility Knives with 18 mm Blades



KG18-01



160 mm



5 KG18-01

Snap Off Blades for Utility Knives 9 mm -
10 Pcs/Dispenser



KSBG09-10DISPEN



1 x 9 x 85 mm



20 KSBG09-10DISPEN

Blades for Utility Knives - 5 Pcs/Retail
Pack



KUBG



0.7 x 85 x 9 mm



20 KUBG09-5P*

Blades for Utility Knives 18 mm - 5 Pcs/
Dispenser



KUBG18-5DISPEN



15 x 30 x 130 mm



20 KUBG18-5DISPEN

Snap Off Blades for Utility Knives 18 mm -
10 Pcs/Dispenser



KSBG18-10DISPEN



15 x 30 x 130 mm



20 KSBG18-10DISPEN

Auto Retractable Safety Utility Knives



KGAU-01



160 mm



5 KGAU-01

Trapezoidal Mini Squeeze Blades for SQZ-MINI Utility Knife



SQZ-MINI-BLADE



28 mm



1 SQZ-MINI-BLADE

Sports Foldable Utility Knives with Polyamide Handle



KGSU-01



160 mm



5 KGSU-01

Holsters for Fixed Utility Knives



KHU-01



90 g



4 KHU-01

Sports Foldable Utility Knives with Aluminium Handle and Twin Blades



KBTU-01



160 mm



5 KBTU-01

Tradesman Laplander Knives with Dual-Component Green Handle



2446-LAP



218 mm



102 mm



15 2446-LAP

218 mm

102 mm

10 SB2446-LAP

SB: Retail packed

Mini Squeeze Retractable Utility Knives with Rubber Grip



SQZ-MINI



160 mm



24 SQZ-MINI

Sports Foldable Knives for Rope Cutting



KBSK-01



170 mm



5 KBSK-01

Sports Foldable Utility Knives with Aluminium Handle



KBSU-01



160 mm



5 KBSU-01

Multipurpose Tradesman Knives with Dual-Component Handle and Double Button Holster



2446



225 mm



100 mm



15 2446

* Until stocks last



Multipurpose Tradesman Stainless-Steel Knives with Dual-Component Handle -15 Pcs/Counter Display



2446-BL

218 mm	102 mm	15	2446-BL

Electrician Stripping Knives for Both Hands Use



2446-EL

32 mm	150 mm	12	2446-EL

Tradesman Electrician's Stripping Knives for Right Hand Use



2446-ELR

34 mm	145 mm	12	2446-ELR

Multipurpose Tradesman Knives with Dual-Component Handle and Safety Blunt Tip



2446-SAFE

215 mm	95 mm	15	2446-SAFE

Electrician Stripping Knives for Both Hands Use Retail Pack



SB2446-EL

150 mm	32 mm	10	SB2446-EL

Multipurpose Tradesman Knives with Dual-Component Handle and Special Holster



2446-OV

220 mm	100 mm	15	2446-OV

Tradesman Knives for Lino Carpets - 12 Pcs/Counter Display



2446-LINO

180 mm	55 mm	12	2446-LINO

Tradesman Electrician's Stripping Knives for Left Hand Use



2446-ELL

34 mm	145 mm	12	2446-ELL

Tradesman Electrician's Knives with Guide



2446-EL-HELP

43 mm	12	2446-EL-HELP

Multipurpose Tradesman Knives with 1-Component Handle - 15 Pcs/Counter Display



1446

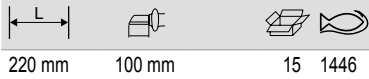

220 mm 100 mm 15 1446

Multipurpose Tradesman Carbon Steel Knives with Single Component Handle - 15 Pcs/Counter Display



1446-CS



218 mm 102 mm 15 1446-CS

Rescue floating knife with fluorescent handle with holster



1446-FLOAT

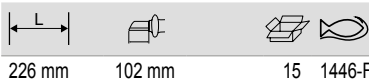

226 mm 102 mm 15 1446-FLOAT

Floating Knife with fluorescent handle



1446-FLOAT-B



225 mm 100 mm 12 1446-FLOAT-B

Without holster

Empty bucket



BUCKET-EMPTY



25 l 6 BUCKET - EMPTY

Bucket for 1446-CS Knives



BUCKET-1446-CS



25 l 1 BUCKET - 1446-CS

BUCKET - EMPTY

1446-CSx 75

Bucket for 1446-FLOAT Knives



BUCKET-1446-FLOAT

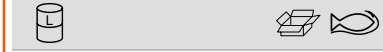

25 l 1 BUCKET-1446-FLOAT

BUCKET - EMPTY

1446-FLOATx 75

Multipurpose Tradesman Knives with 1-Component Handle and Special Holster



1446-OV



225 mm 100 mm 15 1446-OV

Electricians Pinch Knives with Wooden Handle



2820EK-01

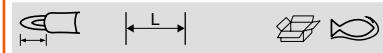

25 mm 130 mm 12 2820EK-01



Electricians Knives with 70 mm Serrated Blades



2820EK

95 mm	205 mm	6	2820EK

Electricians Folding Knives with 70/85 mm Double Blades



2820EF4

75-85 mm	170 mm	1	2820EF4

Electricians Folding Knives with 60 mm Blades



2820EF1

90 mm	200 mm	12	2820EF1

18-in-1 Aluminium Foldable Multitools



MTT151

150 mm	6	MTT151

Electricians Folding Knives with 65 mm Blades



2820EF2

85 mm	195 mm	8	2820EF2

18-in-1 Aluminium Mini Foldable Multitools



MTT121

110 mm	8	MTT121

Electricians Folding Knives with 70 mm Blades



2820EF3

80 mm	170 mm	1	2820EF3

12-in-1 Aluminium Foldable Multitools



MTT051

165 mm	6	MTT051

Windows Scraper with Interchangeable Blade



KRSS-01

80 g	10	KRSS-01

Windows Scrapers with Dual-Component Plastic Body



KBWS-01

70 g	10	KBWS-01



Clamps & Vices



CLAMPS

Quick Clamps with 200 kg Force



QCB

L	QCB
456 mm	6 QCB-150
606 mm	6 QCB-300
756 mm	6 QCB-450
906 mm	4 QCB-600
1206 mm	4 QCB-900
1556 mm	8 QCB-1250

Quick Clamps with 125 kg Force



QCG

L	QCG
380 mm	6 QCG-150
530 mm	6 QCG-300

High Resistance Quick Clamps with 70 kg Maximum Force



QC

X	L	QC
1	230 mm	12 QC-115A
2	230 mm	6 QC-115A-2P
1	305 mm	6 QC-150A
2	305 mm	6 QC-150A-2P
1	475 mm	6 QC-300A
2	475 mm	4 QC-300A-2P

-2P: Twin Pack

F-Clamps with Steel T-Handle 90 mm



3066

L	T-Handle	3066
250 mm	90 mm	5 306601500
300 mm	90 mm	5 306602000
400 mm	90 mm	5 306603000
510 mm	90 mm	5 306604000

F-Clamps with Steel T-Handle 120 mm



3067

L	T-Handle	3067
415 mm	125 mm	5 306703000
510 mm	125 mm	5 306704000
610 mm	125 mm	5 306705000
710 mm	125 mm	5 306706000
910 mm	125 mm	5 306708000
1115 mm	125 mm	5 306710000
1310 mm	125 mm	2 306712000
1610 mm	125 mm	2 306715000

F-Clamps with Steel T-Handle 150 mm



3068

L	T-Handle	3068
430 mm	155 mm	5 306803000
535 mm	155 mm	5 306804000
640 mm	155 mm	2 306805000
730 mm	155 mm	2 306806000
820 mm	155 mm	2 306808000
1135 mm	155 mm	2 306810000
1335 mm	155 mm	2 306812000
1630 mm	155 mm	1 306815000
2130 mm	155 mm	1 306820000

F-Clamps with Steel T-Handle 220 mm



3069

L	T-Handle	3069
430 mm	225 mm	2 306903000
540 mm	225 mm	2 306904000
638 mm	225 mm	2 306905000
730 mm	225 mm	2 306906000
932 mm	225 mm	2 306908000
1130 mm	225 mm	2 306910000

F-Clamps with Rubberised Handle



420SH

L	T-Handle	420SH
100 mm	50 mm	10 420SH-50-100
200 mm	50 mm	10 420SH-50-200
120 mm	60 mm	12 420SH-60-120
300 mm	60 mm	12 420SH-60-300
160 mm	80 mm	12 420SH-80-160
200 mm	100 mm	10 420SH-100-200
250 mm	120 mm	8 420SH-120-250
300 mm	120 mm	8 420SH-120-300
400 mm	120 mm	6 420SH-120-400
500 mm	120 mm	6 420SH-120-500
600 mm	120 mm	6 420SH-120-600
800 mm	120 mm	6 420SH-120-800
1000 mm	120 mm	6 420SH-120-1000
1250 mm	120 mm	6 420SH-120-1250
1500 mm	120 mm	6 420SH-120-1500
400 mm	140 mm	6 420SH-140-400
400 mm	175 mm	6 420SH-175-400

Handy Spring Clamps with Movable Gripping Surface



420SC

	g		
25 mm	60 g	10	420SC-25
50 mm	120 g	5	420SC-50

Heavy Duty Round Guide Bench Vices with Interchangeable Jaws, Suitable for Swivel Base



6010

80 mm	1	601000800
100 mm	1	601001000
125 mm	1	601001250
150 mm	1	601001500

Pair of Spare Pipe Jaw Set for 834V-4, 834V-7 & 6072 Bench Vices



833P

100 mm	1	833PJ-4
125 mm	1	833PJ-5
150 / 175 mm	1	833PJ-67

BENCH VICES

Heavy Duty Square Guide Bench Vices with Interchangeable Jaws



834V

100 mm	1	834V-4
125 mm	1	834V-5
150 mm	1	834V-6
175 mm	1	834V-7

Slide adjustment screw to regulate the looseness with pipe holding jaws

Round Guide Portable Bench Vices with Interchangeable Jaws



834V-2

63 mm	1	834V-2

Spare Spindles and Nuts for 6072 and 834V Bench Vices



6070H

100 mm	1	6070H1000
125 mm	1	6070H1250
150 mm	1	6070H1500
175 mm	1	6070H1750

Heavy Duty Square Guide Bench Vices with Interchangeable Jaws, Suitable for Swivel Base



6072

100 mm	1	607201000
125 mm	1	607201250
150 mm	1	607201500
175 mm	1	607201750

Pair of Spare Jaws and Screws for 6072 and 834V Bench Vices



6072M

100 mm	834V-4, 607201000	1	6072M1000
150 mm	834V-6, 607201500	1	6072M1500
175 mm	834V-7, 607201750	1	6072M1750

125 mm size jaw common for round & square models

Pair of Spare Jaws and Screws for 6010 Bench Vice



6010M

80 mm	601000800	1	6010M0800
100 mm	601001000	1	6010M1000
125 mm	834V-5, 607201250, 601001250	1	6010M1250
150 mm	601001500	1	6010M1500

125 mm size jaw common for round & square models



Spare Spindles and Bolts for 6010 Bench Vice



6010H

Length	Quantity	Part Number
80 mm	1	6010H0800
100 mm	1	6010H1000
125 mm	1	6010H1250
150 mm	1	6010H1500

Pair of Spare Aluminium Jaws with magnetic strip



833AJ

Length	Quantity	Part Number
100 mm	1	833AJ-4
125 mm	1	833AJ-5
150 mm	1	833AJ-6

Pair of Spare Jaws for 834V-2 Table Vice



6040M/H

Length	Quantity	Part Number
63 mm	1	6040M0630

Pair of Spare Polyurethane Jaws with magnetic strip

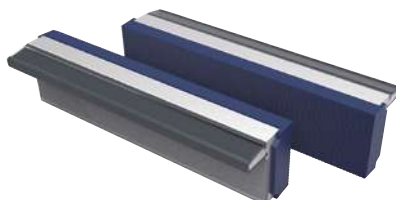

833FJ

Length	Quantity	Part Number
100 mm	1	833FJ-4
125 mm	1	833FJ-5
150 mm	1	833FJ-6

BENCH VICE ACCESSORIES

Swivel Bases for 6010/6072 and 834V Bench Vices



833SB

Length	Quantity	Part Number
80 mm	1	833SB-4
100 mm	1	833SB-5
125 mm	1	833SB-6
150 mm	1	833SB-7



Hammers





CLAW HAMMERS

ERGO™ Claw Hammers with Rubber Grip 

ergo



529

	 
450 g	4 529-16-L
450 g	4 529-16-XL
570 g	4 529-20-L
570 g	4 529-20-XL*

ERGO™ Straight Claw Hammers with Bi-Material Rubber Grip 

ergo





529S

	 
450 g	4 529S-16-XL
570 g	4 529S-20-XL

Claw Hammers with Rubber Grip Steel Tube Handle 



429

	 
230 g	4 429-8
370 g	4 429-13
450 g	4 429-16
570 g	4 429-20

Claw Hammers with Rubber Grip Fibreglass Handle 





428

	 
450 g	4 428-16

Claw Hammer rubber grip with curved nails 



428F

	 
230 g	4 428F-8
370 g	4 428F-13
454 g	4 428F-16
567 g	4 428F-20
680 g	4 428F-24

Claw Hammer rubber grip with RIP nails 





428S

	 
454 g	4 428S-16*
567 g	4 428S-20*

Claw Hammers with Anti-Slip Surface Wooden Handle 



427

	 
230 g	4 427-8*
370 g	4 427-13*
450 g	4 427-16
570 g	4 427-20
680 g	4 427-24*

Claw Hammer with RIP nails and polish head 



427S

	 
454 g	4 427S-16*
567 g	4 427S-20*

Spanish Style Claw Hammers with Dotted Grip Hickory Handle 



427

	 
700 g	6 427-700*

Spanish Style Claw Hammers with Rubber Grip Tri-Material Handle



428

700 g	6	428-700*

NAIL PULLERS

Compact Nail Pullers with Thermoplastic Handle



36

220 mm	5	36

ENGINEERING HAMMERS

Ball Pein Hammers with Hickory Handle



479

230 g	6	479-08
340 g	6	479-12
450 g	6	479-16
570 g	6	479-20
800 g	6	479-24
900 g	6	479-32

Ball Pein hammer with fiberglass Handle



479F

230 g	6	479F-08
340 g	6	479F-12
450 g	6	479F-16
570 g	6	479F-20
680 g	6	479F-24
900 g	6	479F-32

German DIN Locksmith's Hammers



481

100 g	6	481-100
200 g	6	481-200
300 g	6	481-300
400 g	6	481-400
500 g	6	481-500
800 g	6	481-800
1000 g	6	481-1000
1500 g	6	481-1500
2000 g	6	481-2000

German DIN Hammer Fiberglass Handle



481F

100 g	6	481F-100
200 g	4	481F-200

300 g	6	481F-300
400 g	6	481F-400
500 g	6	481F-500
800 g	6	481F-800
1000 g	6	481F-1000
1500 g	4	481F-1500
2000 g	4	481F-2000

Rivoir Hammers French Pattern with Anti-Sliding Handle



482

300 g	6	482-25
400 g	6	482-28
500 g	6	482-30
800 g	6	482-35
1000 g	6	482-40
1500 g	6	482-45

Rivoir Hammer Fiberglass Handle



482F

300 g	4	482F-25
400 g	4	482F-28
470 g	6	482F-30
800 g	4	482F-35
1000 g	2	482F-40
1500 g	4	482F-45

* Until stocks last



Warrington Hammers English Joiner's with Cross Pein



480

230 g	4	480-08
280 g	6	480-10
340 g	6	480-12
400 g	6	480-14
570 g	4	480-20

Carpenter Hammers Spike Claw with Forged Head



485W

650 g	6	485W-650
750 g	6	485W-750
	1	SH-485W
	1	SH-485W-PLATES

Cross Pein Pin Hammers with Hickory Handle



490

100 g	4	490-3.5*

Pattern Makers Hammers with Ball Pein and Hickory Handle



492

100 g	6	492-3.5*

Joiner's Hammers French Pattern



483

100 g	6	483-16
160 g	6	483-20
200 g	6	483-22
300 g	6	483-25
400 g	6	483-28

Club Hammers with Hickory Handle



484

1000 g	6	484-1000
1250 g	6	484-1250
1500 g	6	484-1500
2000 g	4	484-2000

CONSTRUCTION HAMMERS

Carpenter Hammers Spike Claw with Tubular Steel Shaft



485

600 g	6	485	

Joiner Hammer Fiberglass Handle



483F

100 g	6	483F-16
160 g	6	483F-20
200 g	6	483F-22
300 g	6	483F-25
400 g	6	483F-28
500 g	4	483F-30

Club Hammer Fiberglass Handle



484F

1000 g	6	484F-1000
1250 g	6	484F-1250
1500 g	6	484F-1500
2000 g	4	484F-2000

Club Hammers Spanish Type with Oval Eye



407

700 g	5	407-700*
1000 g	6	407-1000*
1400 g	6	407-1400*

Square Head Sledge Hammers with Tri-Material Handle



488F

2000 g	2	488F-2000
3000 g	2	488F-3000
4000 g	2	488F-4000
5000 g	4	488F-5000
6000 g	2	488F-6000

Spanish Type Bricklayer's Hammers with Fibreglass Handle



486F

700 g	6	486F-700*

Club Hammers with Fibreglass Handle



407F

700 g	6	407F-700
1000 g	6	407F-1000
1400 g	6	407F-1400

Bricklayer's Hammers with Hickory Handle



486W

500 g	4	486W-500
600 g	4	486W-600
	1	SH-486W

Bricklayer's Hammers with Rubber Grip



486

600 g	4	486

Square Head Sledge Hammers with Hickory Handle



488

2000 g	2	488-2000
3000 g	2	488-3000
4000 g	2	488-4000
5000 g	2	488-5000
6000 g	1	488-6000

Spanish Type Bricklayer's Hammers with Hickory Handle



486-700

700 g	6	486-700*

Mason's Pin with Pointed Tip



4401

255 mm	10	440102500
300 mm	10	440103000*

* Until stocks last



Spare Wooden Handles for Hammers



WSH



407	1	SH-407
491-3000 & 491-4000	12	SH-491-34
491-5000 & 491-6000	12	SH-491-56
488-2000	10	SH-488-2000
488-3000, 488-4000	10	SH-488-34
488-5000, 488-6000	10	SH-488-56
427-700	10	SH-427-700
486-700, 495-500, 495-600, 493-500, 493-600	10	SH-486-493-495

Spanish Type Shovel-Hatchets with Fibreglass Handle



493F



500 g	6	493F-500*
600 g	1	493F-600*

Plasterer's Hatchets with Tubular Steel Shaft



494



600 g	6	494-600
-------	---	---------

Fibreglass Spare Handles



FSH



488F-2000	10	SH-488F-2000
488F-3000 & 488F-4000	1	SH-488F-34
488F-5000 & 488F-6000	1	SH-488F-56
428-700	10	SH-428-700
486F-700, 495F-500, 495F-600, 493F-500, 493F-600	10	SH-486F493F495F

Spanish Type Shovel-Picks with Hickory Handle



495



500 g	6	495-500*
600 g	6	495-600*

Anti Rebound Hammers with Wooden Handle



3625AR



550 g	34	3625AR-35
1430 g	18	3625AR-50
1550 g	12	3625AR-60

SPECIALTY HAMMERS

Spanish Type Shovel-Hatchets with Wooden Handle



493



500 g	6	493-500*
600 g	6	493-600*

Spanish Type Shovel-Picks with Fibreglass Handle



495F



500 g	6	495F-500*
600 g	1	495F-600*

Spare Tips for 3625AR Hammers



3625ARL



35 mm	3625AR-35	6	3625ARL-35
50 mm	3625AR-50	6	3625ARL-50
60 mm	3625AR-60	6	3625ARL-60

Spare Handle for 3625AR Hammers



3625ARLH

Model	Length (mm)	Weight (g)	Quantity	Part No.
3625AR-35	290 mm	80	80	3625ARLH-35
3625AR-60	300 mm	50	50	3625ARLH-50
3625AR-60	390 mm	16	16	3625ARLH-60

Pein Sledge Hammers with Hickory Handle



491

Weight (g)	Quantity	Part No.
3000 g	4	491-3000
4000 g	4	491-4000
5000 g	4	491-5000
6000 g	4	491-6000

SOFT FACE HAMMERS & MALLETS

Thermoplastic Polyurithane Hammers



3625Y

Weight (g)	Quantity	Part No.
120 g	6	3625Y-22
225 g	6	3625Y-32
372 g	6	3625Y-40
484 g	6	3625Y-50

Dead Blow Sledge Hammers with Anti-Sliding Handle



3625PU

Weight (g)	Quantity	Part No.
300 g	12	3625PU-30
790 g	6	3625PU-50
1080 g	6	3625PU-60

99/105 mm Safety Sledge Hammers with Rubber Handle



489-1100/489-1800

Weight (g)	Quantity	Part No.
1100 g	8	489-1100
1800 g	8	489-1800

Polyflex Plastic Hammers



3625YL

Model	Head Diameter (mm)	Quantity	Part No.
3625Y-22	22 mm	20	3625YL-22
3625Y-32	32 mm	20	3625YL-32
3625Y-35	35 mm	1	3625YL-35*
3625Y-40	40 mm	20	3625YL-40
3625Y-50	50 mm	20	3625YL-50

Dead Blow Sledge Hammers with Anti-Sliding Handle 105 mm



3625PU-105

Weight (g)	Quantity	Part No.
5000 g	4	3625PU-105

150/190 mm Safety Sledge Hammers with Rubber Handle



489-2700/489-5400

Weight (g)	Quantity	Part No.
2700 g	4	489-2700
3600 g	4	489-3600
4500 g	4	489-4500
5400 g	4	489-5400

Superflex Plastic Hammers with Wooden Handle



3625N

Weight (g)	Quantity	Part No.
120 g	6	3625N-22
225 g	6	3625N-32
372 g	6	3625N-40
484 g	6	3625N-50
	1	3625NLH-32*

* Until stocks last



Poll for 3625N Cellulose Acetate hammer



3625NL

3625N-22	22 mm	20	3625NL-22	
3625N-32	32 mm	20	3625NL-32	
3625N-40	40 mm	20	3625NL-40	
3625N-50	50 mm	20	3625NL-50	

Spare Handle for 3625W Hammers



3625WLH

3625W-22	50	3625WLH-22	
3625W-28	50	3625WLH-28	
3625W-35	80	3625WLH-35	
3625W-44	50	3625WLH-44	
3625W-55	16	3625WLH-55	

Rubber Mallets with Wooden Handle



3625RM

290 g	50	3625RM-55
460 g	40	3625RM-65
660 g	30	3625RM-75
850 g	20	3625RM-90

Nylon Tip Mallets with Wooden Handle



3625W

150 g	120	3625W-22
250 g	1	3625W-28
490 g	1	3625W-35
1050 g	1	3625W-44
1470 g	12	3625W-55

Nylon Tip Mallets with Rubber Grip



3625S

350 g	50	3625S-28
610 g	30	3625S-35
1100 g	18	3625S-44

Copper Sledge Hammers with Soft Face



4130

500 g	12	413005000
1000 g	12	413010000
1500 g	12	413015000
2000 g	6	413020000
3000 g	1	413030000
4000 g	1	413040000

Pairs of Poll for 3625W and 3625S Nylon Tipped Mallets



3625WL

3625W-22	22 mm	10	3625WL-22	
3625W-28, 3625S-28	28 mm	10	3625WL-28	
3625W-35, 3625S-35	35 mm	10	3625WL-35	
3625W-44, 3625S-44	44 mm	10	3625WL-44	
3625W-55	55 mm	6	3625WL-55	



Tree Felling & Forestry Tools



AXES, HATCHETS & MAULS

Camping Axes with Curved Ash Wood Handle and Yankee Pattern 380 mm-500 mm



HUS

Length	Weight (g)	Quantity	Model
380 mm	770 g	4	HUS-0.6-380
500 mm	1080 g	4	HUS-0.8-500

Camping Axes with Curved Ash Wood Handle



HGPS

Length	Weight (g)	Quantity	Model
380 mm	944 g	4	HGPS-0.8-380-WB
400 mm	1130 g	4	HGPS-1.0-400-WB
360 mm	790 g	10	HGPS-0.6-360
380 mm	1020 g	4	HGPS-0.8-380
400 mm	1260 g	4	HGPS-1.0-400

Camping Axes with Curved Ash Wood Handle and Yankee Pattern 650 mm



HUS-1.0-650

Length	Weight (g)	Quantity	Model
650 mm	1380 g	4	HUS-1.0-650

Camping Axes with Fibreglass Handle and French Pattern Blade



HFGPS

Length	Weight (g)	Quantity	Model
380 mm	1010 g	4	HFGPS-0,7-400FG

Felling Axes with Curved Ash Wood Handle 800 mm



FGS-810

Length	Weight (g)	Quantity	Model
800 mm	2260 g	4	FGS-1.6-810
800 mm	2460 g	4	FGS-1.8-810

Felling Axes with Hickory Wood Handle and Canadian Style



FCP

Length	Weight (g)	Quantity	Model
800 mm	2500 g	4	FCP-1.8-810
850 mm	3000 g	2	FCP-2.3-860

Felling Axes with Curved Ash Wood Handle 600 mm-700 mm



FGS

Length	Weight (g)	Quantity	Model
700 mm	1730 g	4	FGS-1.25-700-WB
810 mm	2210 g	4	FGS-1.6-810-WB
600 mm	1400 g	4	FGS-1.0-600
700 mm	1850 g	4	FGS-1.25-700

Felling Axes with Fibreglass Handle and French Style



FFSS

Length	Weight (g)	Quantity	Model
900 mm	2400 g	4	FFSS-1.5-900FG

Splitting Axes with Curved Ash Wood Handle



SUS

Length	Weight (g)	Quantity	Model
800 mm	2600 g	4	SUS-2.0-800

Splitting Axes with Hickory Wood Handle



MCP

Length	Weight (g)	Quantity	Model
800 mm	3280 g	2	MCP-2.5-810

Mauls/Sledges with Ash Wood/3-Component Handle and Two Flat Face



LS-MASSE

Length	Weight (g)	Quantity	Model
900 mm	4800 g	2	LS-MASSE-4FG
900 mm	4640 g	2	LS-MASSE-4

Mauls/Sledges with 3-Component Handle and One Flat Face



LS-MASSE-TR

Length	Weight (g)	Quantity	Product Code
900 mm	4840 g	2	LS-MASSE-TR-4FG

Spare Ash Wood Handles for Pick Axes



SH

Length	Quantity	Product Code
800 mm	1	SH-FCS-810
900 mm	1	SH-FCS-860
600 mm	1	SH-FGS-600
700 mm	12	SH-FGS-700
800 mm	1	SH-FGS-800
900 mm	1	SH-FGS-1.8-810
375 mm	1	SH-HFGPS-400FG
400 mm	1	SH-HGPS-400
900 mm	12	SH-MES-F-900
360 mm	12	SH-HGPS-360
380 mm	1	SH-HGPS-380
380 mm	1	SH-HUS-380
500 mm	1	SH-HUS-500
650 mm	1	SH-HUS-650
900 mm	12	SH-MES-900
915 mm	12	SH-MES-900FG
800 mm	12	SH-SUS-800
800 mm	1	SH-MCS-800
905 mm	1	SH-FCP-860

Splitting Axes with Ash Wood/3-Component Handle and One Flat Face



LS/MES

Length	Weight (g)	Quantity	Product Code
900 mm	3390 g	2	LS-MERLIN-2.5
900 mm	3330 g	2	LS-MERLIN-2.5FG
900 mm	3580 g	2	MES-3.0-900

Splitting Axes with Ash Wood/3-Component Handle



MES

Length	Weight (g)	Quantity	Product Code
900 mm	4250 g	2	MES-3.5-900
900 mm	4310 g	2	MES-3.5-900FG

Pick Axes with Fibreglass Handle for Construction Work



PAGES-2.0-900FG

Length	Weight (g)	Quantity	Product Code
900 mm	3000 g	1	PAGES-2.0-900FG

Pick Axes Heads with Round Eye for Construction Work



PAGES

Length	Weight (g)	Quantity	Product Code
520 mm	2000 g	1	PAGES-2.0

Ash Wood/Fibreglass Spare Handles for Pick Axes with Round Eye



SH-PAGES

Length	Weight (g)	Quantity	Product Code
900 mm	690 g	1	SH-PAGES-900
920 mm	1030 g	1	SH-PAGES-900FG

WEDGES

Synthetic Felling Wedges



LS-COIN

Length	Weight (g)	Quantity	Product Code
260 mm	295 g	2	LS-COIN 26 CM
190 mm	170 g	4	LS-COIN 19 CM

Twisted Steel Splitting Wedges



WT

Length	Weight (g)	Quantity	Product Code
220 mm	2000 g	4	W-T-2.0

Traditional Steel Splitting Wedges



WS

Length	Weight (g)	Quantity	Product Code
220 mm	1500 g	4	W-S-1.5
250 mm	2000 g	4	W-S-2.0
260 mm	2500 g	4	W-S-2.5





BAHCO®



Cold Chisels & Punches



COLD CHISELS

Flat Cold Chisels with Octagonal Shank, Plastic Covered



3656

L	W	Q	Part No.
129 mm	12 mm	50	3656-125
155 mm	16 mm	50	3656-150
178 mm	19.5 mm	1	3656-175

Cold Chisels with Flat Oval Shank and Phosphate Finish



3640

L	W	Q	Part No.
150 mm	18 mm	25	3640-150-C
175 mm	21 mm	6	3640-175-C*
200 mm	22 mm	25	3640-200-C
250 mm	28 mm	20	3640-250-C
300 mm	26 mm	25	3640-300-C

Cold Cape Chisels with Flat Oval Shank and Lacquered Copper Finish



3745

L	W	Q	Part No.
150 mm	6 mm	50	3745-150
175 mm	7 mm	25	3745-175
200 mm	8 mm	20	3745-200
250 mm	9 mm	10	3745-250

Cold Chisels with Flat Oval Shank and Lacquered Copper Finish



3740

L	Q	Part No.
100 mm	50	3740-100
125 mm	50	3740-125
150 mm	50	3740-150
175 mm	25	3740-175
200 mm	25	3740-200
250 mm	10	3740-250
300 mm	10	3740-300

Flat Cold Chisels with Octagonal Shank and Lacquered Copper Finish



3756

L	W	Q	Part No.
125 mm	10 mm	50	3756-125
150 mm	12 mm	50	3756-150

Cold Cape Chisel with Octagonal Shank and Lacquered Copper Finish



3749

L	W	Q	Part No.
125 mm	10 mm	50	3749-125

Cold Chisels with Flat Oval Shank and Lacquered Copper Finish Retail Pack



SB-3740

L	Q	Part No.
125 mm	87	SB-3740-125
150 mm	25	SB-3740-150
175 mm	25	SB-3740-175
200 mm	25	SB-3740-200
250 mm	25	SB-3740-250
300 mm	25	SB-3740-300

Cold Cape Chisels with Flat Octagonal Shank, Plastic Covered



3649

L	W	Q	Part No.
128 mm	12 mm	50	3649-125

Slitting Chisels with Flat Oval Shank and Lacquered Copper Finish



3750

L	W	Q	Part No.
240 mm	26 mm	25	3750

Mason's Chisels with Octagonal Shank and Lacquered Copper Finish



3736M

Length (mm)	Quantity	Part Number
200 mm	30	3736M-200
250 mm	25	3736M-250
300 mm	10	3736M-300
400 mm	10	3736M-400

Pointed Chisels with Octagonal Shank and Lacquered Copper Finish



3739-250 / -400

Length (mm)	Width (mm)	Quantity	Part Number
250 mm	16 mm	25	3739-250
300 mm	18 mm	10	3739-300
400 mm	18 mm	10	3739-400

Pointed Chisels with Octagonal Shank and Guard



3739H

Length (mm)	Width (mm)	Quantity	Part Number
250 mm	16 mm	15	3739H-250
300 mm	18 mm	10	3739H-300
400 mm	18 mm	10	3739H-400

Mason's Chisels with Long Flat Shank



8740

Length (mm)	Quantity	Part Number
200 mm	5	874002000
250 mm	5	874002500
300 mm	5	874003000
350 mm	5	874003500
400 mm	5	874004000
500 mm	5	874005000

COLD CHISELS WITH GUARD

Slitting Chisels with Flat Oval Shank and Guard



3750H

Length (mm)	Quantity	Part Number
240 mm	25	3750H

COLD CHISELS, REGRINDABLE

Regrindable Cold Chisels with Flat Shank and Guard



8741

Length (mm)	Quantity	Part Number
200 mm	6	874102000
250 mm	5	874102500
300 mm	5	874103000
350 mm	4	874103500
400 mm	5	874104000

Mixed Chisel Set with Lacquered Copper Finish - 6 Pcs/Box



3736S/6

Weight (g)	Quantity	Part Number
840 g	5	3736S/6

3735-4-120, 3735-5-150

3733-3

3749-125

3756-125, 3756-150

Mason's Chisels with Octagonal Shank and Guard



3736MH

Length (mm)	Quantity	Part Number
250 mm	10	3736MH-250
300 mm	10	3736MH-300
400 mm	5	3736MH-400

Regrindable Pointed Chisels with Octagonal Shank



8746

Length (mm)	Width (mm)	Quantity	Part Number
200 mm	14 mm	5	874602000
250 mm	14 mm	5	874602500
300 mm	16 mm	5	874603000
350 mm	16 mm	5	874603500
400 mm	18 mm	5	874604000

* Until stocks last



Electrician Regrindable Chisels with Octagonal Shank



8760

Length (mm)	Quantity	Part Number
200 mm	10	876002000
250 mm	5	876002500

Regrindable Cold Chisels with Extra Flat Shank



8770

Length (mm)	Quantity	Part Number
240 mm	25	877002400

COLD CHISELS ACCESSORIES

Handles for Cold Chisels



8749

Size	Quantity	Part Number
16x16 mm	1	874916X16
18x18 mm	1	874918X18
23x13 mm	1	874923X13
26x7 mm	1	874926X7

PUNCHES

Centre Punches with Octagonal Shank and Hand Protection



3643

Tip Diameter (mm)	Length (mm)	Quantity	Part Number
3 mm	100 mm	50	3643-100
4 mm	120 mm	50	3643-120
5 mm	120 mm	50	3643-150

Centre Punches with Octagonal Shank and Lacquered Copper Finish



3735

Tip Diameter (mm)	Length (mm)	Quantity	Part Number
4 mm	120 mm	50	3735-4-120
5 mm	120 mm	50	3735-5-120
5 mm	150 mm	50	3735-5-150

Centre Punches with Hexagonal Shank and Chrome Finish



3735N

Tip Diameter (mm)	Length (mm)	Quantity	Part Number
2 mm	100 mm	10	3735N-2-100
4 mm	120 mm	10	3735N-4-120
5 mm	120 mm	10	3735N-5-120
6 mm	150 mm	10	3735N-6-150
8 mm	150 mm	10	3735N-8-150
2 mm	100 mm	1	SB-3735N-2-100
4 mm	120 mm	60	SB-3735N-4-120
5 mm	120 mm	1	SB-3735N-5-120
6 mm	150 mm	1	SB-3735N-6-150
8 mm	150 mm	1	SB-3735N-8-150

SB: With hanging clip

Centre Punch Set with Chrome Finish - 4 Pcs/Wallet



3735NS/4

Weight (g)	Quantity	Part Number
340 g	25	3735NS/4

3735N-6-150, 3735N-8-150, 3735N-2-100, 3735N-4-120

Automatic Centre Punches with Hardened Steel Point



1157

Tip Diameter (mm)	Length (mm)	Quantity	Part Number
2 mm	130 mm	60	1157

Drift Punches with Octagonal Shank and Hand Protection



3644

Tip Diameter (mm)	Length (mm)	Quantity	Part Number
2 mm	120 mm	50	3644-120
3 mm	125 mm	50	3644-125
4 mm	130 mm	50	3644-130
4 mm	150 mm	50	3644-150
5 mm	165 mm	50	3644-165
6 mm	180 mm	50	3644-180
8 mm	200 mm	50	3644-200

Cylindrical Drift Punches with Knurled Guide Sleeve



3659

Ø	L	Icons	Part No.
0.9 mm	70 mm	5	3659-0.9
1.4 mm	81 mm	5	3659-1.4
1.8 mm	84 mm	5	3659-1.8
2.4 mm	92 mm	5	3659-2.4
2.8 mm	95 mm	5	3659-2.8
3.4 mm	97 mm	5	3659-3.4
3.9 mm	100 mm	5	3659-3.9
5.9 mm	100 mm	5	3659-6.0

Cylindrical Drift Punches with Octagonal Shank and Hand Protection



3658A

Ø	L	Icons	Part No.
2 mm	150 mm	125	3658A-2
3 mm	150 mm	125	3658A-3
4 mm	150 mm	125	3658A-4
5 mm	150 mm	125	3658A-5
6 mm	150 mm	125	3658A-6
8 mm	150 mm	50	3658A-8

Ø	L	Icons	Part No.
8 mm	150 mm	10	3734N-8-150
9 mm	150 mm	10	3734N-9-150
10 mm	150 mm	10	3734N-10-150
2 mm	150 mm	1	SB-3734N-2-150
3 mm	150 mm	1	SB-3734N-3-150
4 mm	150 mm	60	SB-3734N-4-150
5 mm	150 mm	1	SB-3734N-5-150
6 mm	150 mm	60	SB-3734N-6-150
7 mm	150 mm	1	SB-3734N-7-150
8 mm	150 mm	1	SB-3734N-8-150
10 mm	150 mm	1	SB-3734N-10-150

Conical Drift Punches with Octagonal Shank and Lacquered Copper Finish



3733

Ø	L	Icons	Part No.
2 mm	120 mm	50	3733-2
3 mm	120 mm	50	3733-3
4 mm	120 mm	50	3733-4
5 mm	120 mm	50	3733-5
6 mm	120 mm	50	3733-6

Cylindrical Drift Punches with Octagonal Shank and Lacquered Copper Finish



3734

Ø	L	Icons	Part No.
2 mm	150 mm	50	3734-2
3 mm	150 mm	50	3734-3
4 mm	150 mm	50	3734-4
5 mm	150 mm	50	3734-5
6 mm	150 mm	50	3734-6
8 mm	150 mm	50	3734-8

Fine Grounded Pin Drift Punch Set with Hand Protection - 6 Pcs/Wooden Stand



3646/6

g	Icons	Part No.
730 g	25	3646/6

3646-115, 3646-125, 3646-150, 3646-165, 3646-180, 3646-200

Fine Grounded Pin Cylindrical Drift Punches with Octagonal Shank and Hand Protection



3646

Ø	L	Icons	Part No.
2 mm	115 mm	250	3646-115
3 mm	125 mm	250	3646-125
4 mm	150 mm	125	3646-150
5 mm	165 mm	125	3646-165
6 mm	180 mm	50	3646-180
8 mm	200 mm	50	3646-200

Cylindrical Drift Punches with Hexagonal Shank



3734N

Ø	L	Icons	Part No.
2 mm	150 mm	10	3734N-2-150
3 mm	150 mm	10	3734N-3-150
4 mm	150 mm	10	3734N-4-150
5 mm	150 mm	10	3734N-5-150
6 mm	150 mm	10	3734N-6-150
7 mm	150 mm	10	3734N-7-150

Chisel and Drift Punch Set - 6 Pcs/Plastic Wallet



3654R

g	Icons	Part No.
870 g	1	3654R

2 x 3656, 1 x 3649, 2 x 3644, 1 x 3643



Drift Punch Set with Knurled Guide Sleeve - 8 Pcs/Plastic Stand



3659/8



270 g



1 3659/8

3659-0.9, 3659-1.4, 3659-1.8, 3659-2.4, 3659-2.8, 3659-3.4, 3659-3.9, 3659-6.0

Cylindrical Drift Punch Set with Hand Protection - 6 Pcs/Wooden Stand



3658A/6



560 g



30 3658A/6

3658A-2, 3658A-3, 3658A-4, 3658A-5, 3658A-6, 3658A-8

Cylindrical Drift Punch Set with Hexagonal Shank - 9 Pcs/Wallet



3734NS/9



750 g



10 3734NS/9

3734N-10-150, 3734N-9-150, 3734N-8-150, 3734N-7-150, 3734N-6-150, 3734N-5-150, 3734N-4-150, 3734N-3-150, 3734N-2-150

Cylindrical Drift Punch Set with Octagonal Shank - 6 Pcs/Box



3734S/6



720 g



5 3734S/6

3734-2, 3734-3, 3734-4, 3734-5, 3734-6, 3734-8

Drift Punch Set with Knurled Guide Sleeve - 8 Pcs/Plastic Wallet



3659/8T



170 g



1 3659/8T

3659-0.9, 3659-2.8, 3659-2.4, 3659-1.8, 3659-6.0, 3659-3.9, 3659-3.4, 3659-1.4

Nail Drift Punches with Plastic Handle Retail Pack



3732



2 mm	125 mm	60	SB-3732-2-125
2.5 mm	125 mm	60	SB-3732-2.5-125
3.2 mm	125 mm	60	SB-3732-3.2-125
4 mm	125 mm	1	SB-3732-4-125

Chisel and Drift Punch Set - 10 Pcs/Plastic Wallet



3656/10



1260 g



1 3656/10

3 x 3656, 1 x 3644, 1 x 3649, 1 x 3643 en 3 x 3646

Conical Drift Punch Set with Octagonal Shank - 5 Pcs/Wallet



3733S/5



410 g



25 3733S/5

3733-4, 3733-2, 3733-6
3733-8, 3733-10

Wad Punch Noses



B400



2 mm	1	B400.002
3 mm	1	B400.003
4 mm	1	B400.004
5 mm	1	B400.005

		
6 mm	1	B400.006
7 mm	1	B400.007
8 mm	1	B400.008
9 mm	1	B400.009
10 mm	1	B400.010
11 mm	1	B400.011
12 mm	1	B400.012
13 mm	1	B400.013
14 mm	1	B400.014
15 mm	1	B400.015
16 mm	1	B400.016
17 mm	1	B400.017
18 mm	1	B400.018
19 mm	1	B400.019
20 mm	1	B400.020
21 mm	1	B400.021
22 mm	1	B400.022
23 mm	1	B400.023
24 mm	1	B400.024
25 mm	1	B400.025
26 mm	1	B400.026
27 mm	1	B400.027
28 mm	1	B400.028
29 mm	1	B400.029
30 mm	1	B400.030
31 mm	1	B400.031
32 mm	1	B400.032
33 mm	1	B400.033
34 mm	1	B400.034
35 mm	1	B400.035
36 mm	1	B400.036
37 mm	1	B400.037
38 mm	1	B400.038
39 mm	1	B400.039
40 mm	1	B400.040
41 mm	1	B400.041
42 mm	1	B400.042
43 mm	1	B400.043
44 mm	1	B400.044
45 mm	1	B400.045
46 mm	1	B400.046
47 mm	1	B400.047
48 mm	1	B400.048
49 mm	1	B400.049
50 mm	1	B400.050

Handles for 2 mm-30 mm Wad Punches





WPH3-30

		
185 mm	500 g	1 WPH 3-30

Interchangeable Wad Punch Set - 16 Pcs/
Plastic Case



400.003.030

	
3-30 mm	1 400.003.030

Handles for 2 mm-50 mm Wad Punches



WPH2-50

		
180 mm	761 g	1 WPH 2-50

Interchangeable Wad Punch Set - 32 Pcs/
Plastic Case



400.002.050

	
2-50 mm	1 400.002.050

Handles for 2 mm-20 mm Wad Punches



WPH3-20

		
95 mm	290 g	1 WPH 3-20

Interchangeable Wad Punch Set - 11 Pcs/
Plastic Case



400.003.020

	
3-20 mm	1 400.003.020

Revolving Wad Punches with Plastic
Handle for 2 mm-4.5 mm



2635

	
245 mm	1 2635



Revolving Wad Punches for 2 mm-4.5 mm



4630

220 mm	1	4630

Knockout Screw Hole Punches



6900

16 mm	1	690000160
20 mm	1	690000200
22 mm	1	690000220
25 mm	1	690000250
30 mm	1	690000300
32 mm	1	690000320
35 mm	1	690000350
40 mm	1	690000400
50 mm	1	690000500
63 mm	1	690000630

Screw Punch Set - 7 Pcs/Plastic Box



6907

4080 g	1	69079019P

- 690000160, 690000250, 690000200, 690000320, 690000500, 690000400, 690000630
- 690900120, 690900080, 690900100, 690900200, 690900140

Spare Screws for 6900 Series Screw Punchers



6909

16 mm	4	690900080
20-25 mm	4	690900100
30-35 mm	2	690900120
40-50 mm	2	690900140
63 mm	1	690900200

PUNCHES WITH 2-COMPONENT HANDLE

Centre Punch with 2-Component Handle and Guard



SB3755BM

4 mm	165 mm	1	SB3755BM-4
6 mm	185 mm	5	SB3755BM-6

SB: Retail pack

Cylindrical Parallel Pin Punch with 2-Component Handle



SB3734BM

3 mm	155 mm	5	SB3734BM-3
4 mm	165 mm	5	SB3734BM-4
5 mm	165 mm	5	SB3734BM-5
6 mm	185 mm	5	SB3734BM-6
8 mm	185 mm	5	SB3734BM-8
10 mm	185 mm	5	SB3734BM-10

SB: Retail pack

Cylindrical Pin Punch Set with Dual-Component Handle - 7 Pcs/Plastic Tray



3734BMS/7

900 g	1	3734BMS/7

3734BM-2, 3734BM-3, 3734BM-4, 3734BM-5, 3734BM-6, 3734BM-8, 3734BM-10

COLD CHISELS WITH 2-COMPONENT HANDLE

Mason's Chisels with 2-component handle



SB3654BM

155 mm	5	SB3654BM-15
185 mm	5	SB3654BM-20

SB: Retail pack

Mixed Mason's Chisel Set with Dual-Component Handle - 7 Pcs/Plastic Tray



3654BMS/7

920 g	1	3654BMS/7

3734BM-2, 3734BM-4, 3734BM-5, 3734BM-6, 3654BM-15, 3654BM-20, 3755BM-6



Pry Bars



WRECKING BARS

Adjustable Pry Bars with V-Claw 260 mm



APB260

260 mm	410 g	10	APB260*

Adjustable Pry Bars with V-Claw 360 mm



APB360

360 mm	543 g	10	APB360*

Pry Bar Crowfoots with Precise End



CFP250

250 mm	6	CFP250

Pry Bar Crowfoot with Precise End 330 mm - 12 Pcs/Display Pack



CFP250-DISP

12	50 x 280 x 330 mm	12	CFP250-DISP*

12x CFP250

CFP250x 12

Premium Wrecking Bars with Bent and Flat End



WBP

14 mm	346 mm	20	WBP300
16 mm	487 mm	12	WBP500
17 mm	625 mm	12	WBP625
17 mm	704 mm	10	WBP710
20 mm	890 mm	6	WBP900

Wrecking Bars with Bent and Flat End



WBB

391 mm	14 mm	10	WBB400
500 mm	16 mm	10	WBB500
595 mm	18 mm	10	WBB600
680 mm	18 mm	6	WBB700

810 mm	18 mm	6	WBB800
1000 mm	20 mm	4	WBB1000
1200 mm	20 mm	4	WBB1200
1500 mm	22 mm	4	WBB1500

Flat Wrecking Bars with Bent and Flat End



WBF380

374 mm	35 mm	12	WBF380

Mini Flat Wrecking Bars with Bent and Flat End



WBMF190

18 mm	188 mm	24	WBMF190

Mini Flat Wrecking Bars with Bent and Flat End - 15 Pcs/Display



WBMF190IP

39 g	15	WBMF190IP



WBMF190x 15

Wrecking Bar Set - Flat, Mini & Premium
with End 621 mm



WBP-3P-6FMF



g	 
3000 g	1 WBP-3P-6FMF



- WBP625 
- WBF380 
- WBMF190 

Flat & Premium Wrecking Bar Set



WBP-3P-96F

g	 
6000 g	1 WBP-3P-96F

- WBP900, WBP625 
- WBF380 

* Until stocks last





BAHCO®



Planting & Cultivating Tools



SMALL GARDEN TOOLS

Hoes with Dual-Component Handle



P262

315 mm	10	P262

One Point Hoes with Dual-Component Handle and Long Metal Rod



P278

455 mm	5	P278

Trowels with Dual-Component Handle



P263

370 mm	10	P263

Border Hoes with Dual-Component Handle



P272

450 mm	5	P272

Two Point Hoes with Dual-Component Handle



P267

320 mm	10	P267

Cultivators with Dual-Component Handle



P264

315 mm	10	P264

One Point Hoes with Dual-Component Handle



P268

320 mm	10	P268

Two Point Hoes with Dual-Component Handle and Long Metal Rod



P277

455 mm	5	P277

Border Cultivators with Dual-Component Handle



P274

470 mm	5	P274

Border Rakes with Dual-Component Handle



P276



450 mm



5 P276

Weeding Forks with Dual-Component Handle



P270



305 mm



10 P270

Rakes with Dual-Component Handle



P266



335 mm



10 P266

Bulb Planters with Solid Wooden Handle



P241



340 g



5 P241

Daisy Grubbers with Dual-Component Handle



P269



315 mm



10 P269



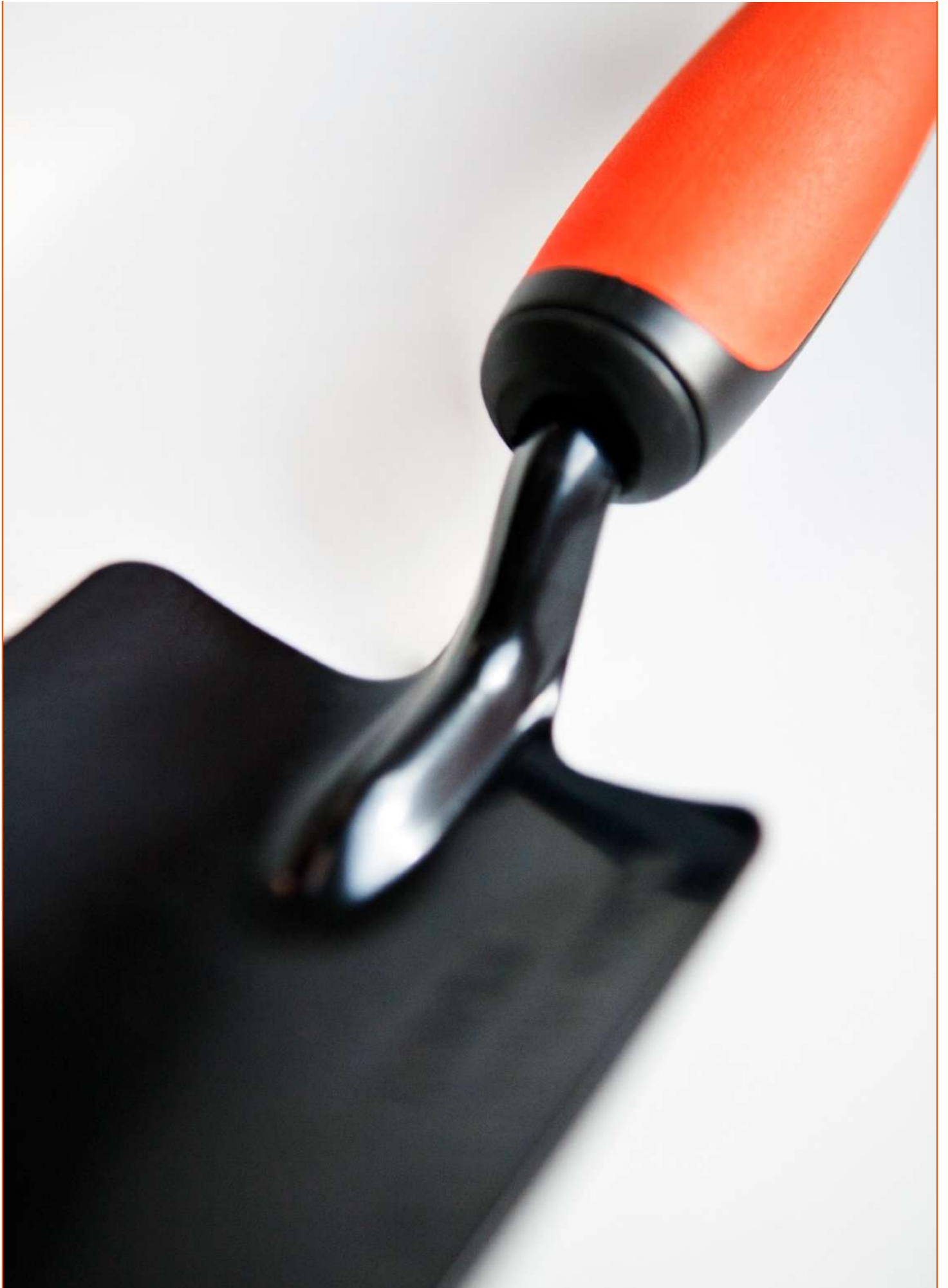

BAHCO®



Pruning Tools



SECATEURS

ERGO™ Bypass Secateurs with Elastomer Coated Fixed Handle



ergo



PX



15 mm	2	PX-S1
20 mm	2	PX-S2
15 mm	2	PX-M1
20 mm	2	PX-M2
20 mm	2	PX-M2-L
30 mm	2	PX-M3
20 mm	2	PX-L2
30 mm	2	PX-L3

ERGO™ Bypass Secateurs with Elastomer Coated Rotating Handle



ergo



PXR



20 mm	2	PXR-S2-L
15 mm	2	PXR-S1
20 mm	2	PXR-S2
15 mm	2	PXR-M1
20 mm	2	PXR-M2
20 mm	2	PXR-M2-L
30 mm	2	PXR-M3
20 mm	2	PXR-L2

Spare Pre-assembled Cutting Heads for PX and PXR ERGO™ Bypass Secateurs



R801P-R804P



1	1	R801P
2	1	R802P
3	1	R803P
2	1	R804P

Spare Cutting Blades for ERGO™ Bypass Secateurs



R211P/R300P/R500P/R600P

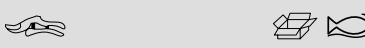

Px/ Pxr N° 2, P1-20, P2-20	1	R211P
PX/ PXR N° 2, P1-20, P2-20	80	R211P-BULK80
Px/ Pxr N° 1	1	R300P
Px/ Pxr N° 3	40	R500P
Px-M2-L & Pxr-M2-L	1	R600P

Spare Counter Blades for PX and PXR ERGO™ Bypass Secateurs



R303P-R603P



Px-S1, Px-M1, Px-L1, Pxr-M1, Pxr-L1	1	R303P
Px-S2, Px-M2, Px-L2, Pxr-M2, Pxr-L2	1	R403P
Px-S3, Px-M3, Px-L3, Pxr-M3, Pxr-L3	1	R503P
Px-M2-L, Pxr-M2-L	1	R603P

Spare Pair of Handles for PX and PXR ERGO™ Bypass Secateurs



ergo



R811P-RT825P



Px-S	1	R811P
Px-M	1	R812P
Px-L	1	R813P
Px-M2-L	1	R815P
PxR-S	1	RT821P
PxR-M	1	RT822P
PxR-L	6	RT823P
PxR-M2-L	1	RT824P
PXR-S2-L	6	RT825P

Spare Centre Bolts for ERGO™ Bypass Secateurs



R900P



PX & PXR	20 g	1	R900P
----------	------	---	-------

Spare Centre Bolt Locking Systems for ERGO™ Bypass Secateurs



R901P



PX & PXR	10 g	30	R901P
----------	------	----	-------

Spare Four Handle Screws with Inserts for PX and PXR ERGO™ Bypass Secateurs



R902P

Icon	g	Icon	Icon
PX & PXR	20 g	24	R902P

Spare Springs for P64 and ERGO™ Bypass Secateurs



R905P-R907P

Icon	g	Icon	Icon
PX & PXR, P64	10 g	1	R905P
PX & PXR, P64	164 g	50	R905P-BULK50
PX & PXR	10 g	1	R906P
PX & PXR	220 g	50	R906P-BULK50
PX & PXR	10 g	1	R907P

Bypass Secateurs with Composite Handle and Angled Head



P1

Icon	L	Icon	Icon
20 mm	200 mm	5	P1-20
30 mm	230 mm	5	P1-23

Spare Two Buffers for PX/PXR, P1/P2, P64 ERGO™ Bypass Secateurs



R903P/R1269P

Icon	g	Icon	Icon
PX & PXR, P1 & P2, P64	10 g	1	R903P
PX & PXR, P1 & P2, P64	486 g	50	R1269P-BULK50

Bypass Secateurs with Forged Steel Handle and Large Cutting Head



P3

Icon	L	Icon	Icon
20 mm	200 mm	2	P3-20-F
25 mm	230 mm	2	P3-23-F

Bypass Secateurs with Soft Grip Composite Handle and Narrow Cutting Head



P108

Icon	L	Icon	Icon
20 mm	200 mm	2	P108-20-F
25 mm	230 mm	2	P108-23-F

Spare Locking Devices for PX and PXR ERGO™ Bypass Secateurs



R904P

Icon	g	Icon	Icon
Px & Pxr	10 g	1	R904P

Bypass Secateurs with Stamped/Pressed Steel Handle and Narrow Cutting Head



P110

Icon	L	Icon	Icon
20 mm	200 mm	2	P110-20-F
25 mm	230 mm	2	P110-23-F

Bypass Secateurs with Forged Steel Handle and Narrow Cutting Head



P5

Icon	L	Icon	Icon
25 mm	230 mm	2	P5-23-F



Anvil Secateurs with Stamped/Pressed Steel Handle



P138

Blade Length	Handle Length	Blade Width	Blade Shape	Quantity	Product Code
20 mm	220 mm	6	P138-22-BULK6	6	P138-22-F
20 mm	220 mm	6	P138-22-F		

Bypass Secateurs with Stamped/Pressed Steel Handle and Angled Cutting Head



P121

Blade Length	Handle Length	Blade Width	Blade Shape	Quantity	Product Code
15 mm	180 mm	6	P121-18-F	6	P121-20-F
20 mm	200 mm	6	P121-20-F		
25 mm	230 mm	6	P121-23-F		

Spare Anvils and Rivets



R221P/R222P

Blade Length	Blade Width	Blade Shape	Quantity	Product Code
P138-22	1	R221P		
P138-22	50	R221P-BULK50		

Cut and Hold Secateurs with Composite Handle



P64

Blade Length	Handle Length	Blade Width	Blade Shape	Quantity	Product Code
12 mm	210 mm	12	P64-20-BULK12		

Bypass Secateurs with Stamped/Pressed Steel Handle and Straight Cutting Head



P126

Blade Length	Handle Length	Blade Width	Blade Shape	Quantity	Product Code
15 mm	190 mm	6	P126-19-F	6	P126-22-F
20 mm	220 mm	6	P126-22-F		

Spare Cutting Blades for P1-22, P2-22, P6 Bypass Pruners/P7 Left-Handed Pruners



R201P/R171P

Blade Length	Blade Width	Blade Shape	Quantity	Product Code
P1-22, P2-22	1	R201P		
P1-22, P2-22	80	R201P-BULK80		

Left and Right Handed Bypass Secateurs with Fibreglass Handle



PG-01-F/PG-03-L

Blade Length	Blade Width	Blade Shape	Quantity	Product Code
12-20 mm	6	PG-01-F		
12-20 mm	2	PG-03-L		

Left and Right Handed Bypass Secateurs with Composite Handle



PG-12-F

Blade Length	Handle Length	Blade Width	Blade Shape	Quantity	Product Code
20 mm	210 mm	10	PG-12-F		
20 mm	210 mm	15	PG-12-BULK15		

Spare Blade for P4 Bypass Secateurs



R301P

Blade Length	Weight	Blade Shape	Quantity	Product Code
P4-20, P4R-20	41 g	R301P	30	

Spare Cutting Blades for Hand and Top-Pruners



R112PG-R124PG/R224P

P3-20, P5-20	1	R112PG
P108-20, P110-20	1	R114PG
P3-23, P5-23	30	R122PG
P108-23, P110-23, P34-27A	30	R124PG
P138-22	1	R223P
P138-22	80	R223P-BULK80

Spare Centre Bolts for P4 Bypass Secateurs



R900P-Z

P4-20, P4-23, P4R-20, P4R-23	21 g	24 R900P-Z

Spare Counter Blades and Pins for Hand-Pruners



R113PG/R123PG

P108-20, P110-20	30	R113PG
P108-23, P110-23	30	R123PG

Spare Counter Blades for P1-22, P2-22 Bypass Pruners/P6 and P7 Left-Handed Pruners



R202P/R271P

P1-22, P2-22	1	R202P

Spare Spring for P4 Bypass Secateurs

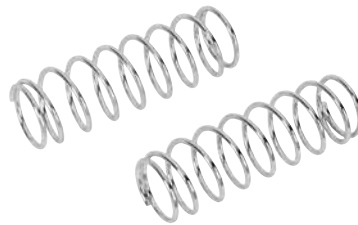

R906P-Z

P4-20, P4-23, P4R-20, P4R-23	8 g	12 R906P-Z

Spare Closing Springs



R341P/R474P

P3-20, P3-23	12	R341P
P5-20, P5-23, P108-20, P108-23, P110-20, P110-23	1	R474P

Spare Counter Blade for P4 Bypass Secateurs



R304P

P4-20, P4R-20	45 g	1 R304P

Spare Centre Bolt/Nut/Washer Set for Pruners



R239P/R141P/R142P/R157H

P34-27A, P3-20, P3-23, P5-20, P5-23, P108-20, P108-23, P110-20, P110-23	24	R142P
P121-23	1	R148V
P1-20, P1-22, P2-20, P2-22, P6-20, P7-20	1	R239P

Spare Springs for One-Hand Pruners

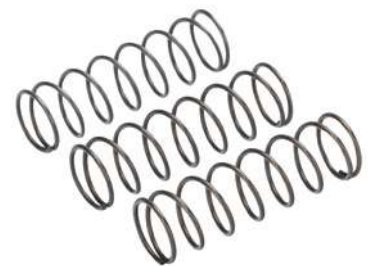

R438P/R463P

P121-20	1	R434P
P121-20	50	R434P-BULK50
P121-23	1	R463P
P138-22	1	R438P
P138-22	50	R438P-BULK50



Spare Spring and Buffer Set for One-Hand Pruners



R1069P



P1-20, P2-20, P6-20, P7-20

12 R1069P

Spare Handle Screws/Nuts/Closing Button Set with Flat Spring for Pruners



R1601



P1-20, P1-22, P2-20, P6-20, P7-20

1 R1601

Straight Short Snip with Fibreglass Handle



P127



6 mm

30 P127-19-BULK30



Spare Springs, Buffers and Buffer Cup Set for One-Hand Pruners



R1068



P3-20, P3-23, P5-20, P5-23, P108-20, P108-23, P110-20, P110-23

1 R1068

Spare Locking Device with Screws and Nuts for P108 and P5 Bypass Secateurs



R478P/R480P



P108
P5

1 R478P
1 R480P

Straight Long Snip with Fibreglass Handle



P128



6 mm

6 mm

6 P128-19

30 P128-19-BULK30



FRUIT PICKING TOOLS

Spare Part Kit for P5-20 and P5-23 Re-Designed Secateurs



R1080P



P5-20, P5-23

1 R1080P

Bypass Snips with Fibreglass Handle



P123



10 mm

30 P123-19-BULK30



11° Angled Snips with Fibreglass Handle



P129



6 mm

30 P129-19-BULK30



Spare Springs with Buffers for Snips



R1071/R1075

P123, P127, P128, P129	20 g	14	R1071
P123, P127, P128, P129	130 g	50	R1075-BULK50

30 mm Professional Bypass Loppers with Wooden Handle and Forged Counter Blade



P16-40W

30 mm	400 mm	2	P16-40W

50 mm Professional Bypass Loppers with Aluminium Handle



P19

50 mm	800 mm	1	P19-80-F

LOPPERS

30 mm Professional Lightweight Bypass Loppers with Aluminium Handle



P114-SL

30 mm	400 mm	2	P114-SL-40
30 mm	500 mm	2	P114-SL-50
30 mm	600 mm	2	P114-SL-60

35 mm Professional Lightweight Bypass Loppers with Aluminium Handle



P116-SL

35 mm	400 mm	2	P116-SL-40
35 mm	500 mm	2	P116-SL-50
35 mm	600 mm	2	P116-SL-60
35 mm	700 mm	2	P116-SL-70

55 mm Professional Lightweight Long Bypass Loppers with Aluminium Handle



P280-SL

55 mm	600 mm	2	P280-SL-60
55 mm	800 mm	2	P280-SL-80

30 mm Professional Bypass Loppers with Steel Handle and Forged Counter Blade



P16

30 mm	400 mm	2	P16-40
30 mm	500 mm	2	P16-50-F
30 mm	600 mm	2	P16-60-F

45 mm Professional Lightweight Long Bypass Loppers with Aluminium Handle and Forged Counter Blade



P160-SL

45 mm	600 mm	2	P160-SL-60
45 mm	750 mm	1	P160-SL-75
45 mm	900 mm	1	P160-SL-90

Professional Anvil Loppers with Lever Action and Aluminium Handle



P173-SL

45 mm	850 mm	1	P173-SL-85



35 mm Bypass Loppers with Steel Handle



P130-P140

Width	Length (L)	Quantity	Model
40 mm	450 mm	6	P130-F
40 mm	660 mm	6	P140-F

40 mm Expert Bypass Loppers with Dual-Component Handle



PG-18

Width	Length (L)	Quantity	Model
40 mm	450 mm	2	PG-18-45-F
40 mm	610 mm	2	PG-18-60-F

40 mm Expert Bypass Telescopic Loppers with Dual-Component Handle



PG-19

Width	Length (L)	Quantity	Model
40 mm	700 - 900 mm	2	PG-19-F

Spare Cutting Blades for Loppers



R114V/R373A

Model	Quantity	Model	Quantity
P160-SL	28	R160A-BULK28	
P280-SL-80	25	R185V	
P14	25	R114V	
P14	28	R114V-BULK28	
P-SL2, P116-SL	1	R16V	
P-SL2, P116-SL	14	R16V-BULK14	
P-SL, P114-SL	8	R115V	
P-SL, P114-SL	14	R115V-BULK14	
P16	1	R116V	
P16	36	R116V-BULK36	
P19-80	1	R119V	
P160	1	R160A	
P173-SL-85	25	R373A	

Spare Counter Blades for Loppers



R214V/R260A...

Model	Quantity	Model	Quantity
P14	1	R214V	
P14	28	R214V-BULK28	
P116-SL	8	R216SL	
P114-SL	1	R214SL	
P160	16	R260A	
P16*	40	R716VCB	
P180-70	1	R680V	
P19-80	1	R619V	

Spare Buffers for Loppers and Hedge Shears



R440V

Model	Quantity	Model	Quantity
P-SL, P-SL2, P114, P116, P52-SL, P54-SL	22	R440V	

Spare Anvils with Screws for Loppers



R372H

Model	Quantity	Model	Quantity
P172-65 /-85, P172-SL	1	R372H	

Spare Central Bolt and Nut Set for Loppers



R312V-R318V/R143PV/R144PV/R146

Model	Quantity	Model	Quantity
P280-SL	12	R335V	
P16	1	R143PV	
P16*	1	R143PVCB	
P160	24	R144PV	
P14, P174, P176-75	24	R146VS	
P14, P174, P176-75	50	R146VS-BULK50	
P114-SL, P116-SL	22	R166V	
P-SL-40 /-45 /-60	1	R315V	
P280-(SL)	22	R328V	
P180-70, P19-80, P172	1	R318V	

Spare Handle Bolt and Nut Set for Loppers



R415V-R775V

Model	Quantity	Model	Quantity
P280-SL	1	R775V	
P173-SL-85	1	R776V	
P-SL, P-SL2, P114, P116	1	R415V	
P19-80	1	R519V	
P14, P16	1	R615V	
P160	24	R660V	
P172-SL	14	R772V	
P280-SL-80	1	R773V	

Hexagonal Screws for Adjusting Blade to Anvil



R272H



P173-SL-85
P172-65/-85, P172-SL-85

30 R472H
1 R272H

Aluminium Compact Telescopic Poles



ATP-110-210



1100 - 2100 mm



1 ATP-110-210

Adaptors for Pole Saws



ASP-AS



135 mm



6 ASP-AS

POLE SAWS & TOP PRUNERS

Telescopic aluminium poles



ATP-200



2000-3520 mm
2070-5040 mm



1 ATP-200-350
1 ATP-200-500

Aluminium Base Section Poles



ASP-1850G



1870 mm



1 ASP-1850G

Adaptors for P34-37/P134/P34-27A-F Top Pruner



ASP-ATP



160 mm



100 g



6 ASP-ATP

Aluminium or Fibreglass Telescopic Poles



AP-/FP-



2000 - 5000 mm
2000 - 3500 mm
1800 - 3200 mm



1 AP-5M
1 AP-3M
1 FP-3M

Aluminium Extension Poles



ASP-1850



1870 mm



1 ASP-1850

Adaptor for section and telescopic poles



RAUNI



ATP-110-210



82 g



6 RAUNI



Pole Hooks with Adaptor for ASP and ATP Poles



ASP-AS-HOOK

LIGHT



325 g



4 ASP-AS-HOOK

Top Pruners on Telescopic Pole



ATP-230-410



32 mm



2370 - 4110 mm



2 ATP-230-410

Spare Blade Kit for ATP-230-410 Telescopic Top Pruner



R230P



ATP-230-410



62 g



10 R230P

Top Pruners with Triple Pulley Action



P34-37



40 mm



2 P34-37

Top Pruners with Pull Cord



AP-234



30 mm



2200 mm



2 AP-234-F

Spare Spring for ATP-230-410 Telescopic Top Pruner



R4230



ATP-230-410



7 g



10 R4230

Top Pruners with Single Pulley Action



P34-27A



30 mm



2 P34-27A-F

Spare cutting blades for top-pruners P34-37



R137E



P34-37



30 R137E

Spare Rubber Bumper for Short Telescopic Pole



RBCP



ATP-110-210



30 g



10 RBCP

Spare Rubber Bumper & Inner Handle for Telescopic Top Pruner



RBCP230

ATP-230-410	66 g	12	RBCP230

Spare Centre Bolt and Nut Set for P34-37 Top Pruners



R142P/R337E

P34-37	1	R337E

Spare Lever for Cutting Head for ATP-230-410 Telescopic Top Pruner



RPL230G

ATP-230-410	72 g	8	RPL230G

Spare Cam for ATP Telescopic Poles



RCAM

ATP-200-350 ; ATP-200-500 ; ATP-110-210	29 g	20	RCAM30
ATP-200-500 ; ATP-110-210	37 g	20	RCAM36

Spare Rope for Cutting Head for ATP-230-410 Telescopic Top Pruner



RD7M

ATP-230-410	19 g	20	RD7M

Spare Springs for P34-27A Top Pruner



R427AE/R427E/R437E

P134, P34-27A P34-37	18	R427AE R437E

Spare Rope for Cutting Head



RD1M

ATP-230-410	5 g	15	RD1M

Spare Counter Blades for Top-Pruners



R133PG

P34-27A	1	R133PG

Fine Cut Pole Pruning Saws



ASP-AS-C F

330 mm	7	5	ASP-AS-C33-JT-F



Medium Cut Pole Pruning Saws



ASP-AS-C M

360 mm	6.2	5	ASP-AS-C36-JT-M

Hardpoint and Fileable Teeth Pole Pruning Saws with Steel Tube Handle



383-/384-

360 mm	6	4	383-6T
360 mm	6	4	384-6T
360 mm	5	4	384-5T

Heavy Duty Lightweight Hedge Shears with Aluminium Handle



P51-SL

570 mm	25 cm	2	P51-SL

Coarse Cut Pole Pruning Saws



ASP-AS-C C

390 mm	5.4	5	ASP-AS-C39-JT-C
450 mm	5.4	2	ASP-AS-C45-JT-C

Hardpoint and Fileable Teeth Pole Pruning Saws with Steel Tube Handle and Extended Hook Tip



385-/386-

360 mm	6	4	385-6T
360 mm	6	4	386-6T

Heavy Duty Extra Long Lightweight Hedge Shears with Aluminium Handle



P51H-SL

730 mm	25 cm	2	P51H-SL

HEDGE SHEARS

Hardpoint and Fileable Teeth Pole Pruning Saws with Plastic Handle



339-/340-

360 mm	6	4	339-6T
360 mm	6	4	340-6T

Heavy Duty Lightweight Hedge Shears with Steel Handle



P51

570 mm	25 cm	2	P51-F

Heavy Duty Hedge Shears with Wooden Handle



P57-25

540 mm	23 cm	4	P57-25-F

Lightweight Precision Hedge Shears with Aluminium Handle



P54-SL



550 mm 22.5 cm 2 P54-SL-25



Precision Hedge Shears with Aluminium Handle



PG-56



540 mm 23 cm 2 PG-56-F



Spare Buffers for Hedge Shears



R444V-R516V

P14, P16, P180-70, P19-80, P160-60, P51	22	R515VS
P160, P160-SL, P280-SL	22	R516V
P53-SL, P54H-SL, P52-SL-20	22	R444V

Long Lightweight Precision Hedge Shears with Aluminium Handle



P54H-SL



650 mm 22.5 cm 2 P54H-SL-25



Expert Telescopic Hedge Shears with Aluminium Handle



PG-57-F



800-1050 mm 20 cm 2 PG-57-F



Centre Bolt/Nut/Locking Ring Set for Hedge Shears



R146VC/R147V

P51, P51H, P52, P53, P54, P52-SL-20, P74, P75	22	R146VC
P55, P57	24	R147V

Lightweight Extra Precision Hedge Shears with Aluminium Handle



ergo®



P52-SL-20



590 mm 18 cm 2 P52-SL-20



Universal Hedge Shears with Steel Handle



P59



580 mm 21 cm 6 P59-25-F



GRASS SHEARS

3-Positions Grass Shears with Plastic Sleeve Handle



GS-76



355 mm 435 g 8 GS-76



Multi-Angle Grass Shear



GS-180

375 mm	317 g	6	GS-180-F

Duck's Foot Grass Shears with Plastic Sleeve Handle 1100 mm



P74

1100 mm	2000 g	40	P74

Grass Shears with Plastic Sleeve Handle 1000 mm



P75

1000 mm	1900 g	1	P75

SCISSORS

Floral Scissor with Soft Touch Finger Loop - Small



FS-5

10	FS-5

Floral Scissor with Soft Touch Finger Loop - Medium



FS-8

10	FS-8

Floral Scissor with Soft Touch Finger Loop - Large



FS-7.5

10	FS-7.5

BOW SAWS

ERGO™ Heavy Duty Professional Bow Saws 21"-30"



10

530 mm	21 in	5	10-21-51
607 mm	24 in	5	10-24-23
607 mm	24 in	5	10-24-51
759 mm	30 in	5	10-30-23
759 mm	30 in	5	10-30-51

ERGO™ Pointed Heavy Duty Professional Bow Saws 21"



332

530 mm	21 in	5	332-21-51

General Purpose Bow Saws 21" to 36"



SE -15/-16

530 mm	21 in	5	SE-16-21
530 mm	21 in	5	SE-16-21-23
607 mm	24 in	5	SE-15-24
759 mm	30 in	5	SE-15-30
759 mm	30 in	5	SE-15-30-23
810 mm	32 in	5	SE-15-32
912 mm	36 in	5	SE-15-36
912 mm	36 in	5	SE-15-36-23

Pointed Bow Saws for Dry Wood 21"



331-21



530 mm 21 in 5 331-21-51-KP

General Purpose Bow Saws with Reversible Blade 21"



2-21-51



530 mm 21 in 5 2-21-51

Toolbox-Sized Mini Bow Saw 12"



9-12



320 mm 12 in 5 9-12-51/3806-KP

Pointed Bow Saws for Green Wood 15"



331-15



378 mm 15 in 5 331-15-23

General Purpose Bow Saws with Reversible Blade 14"



333



350 mm 14 in 5 333

Dry Wood Spare Blades for Bow Saw 12"-36"



51

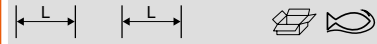

320 mm	12-1/2 in	10	51-12
530 mm	20.75 in	10	51-21
607 mm	24 in	10	51-24
759 mm	30 in	10	51-30
810 mm	28.57 in	10	51-32
912 mm	36 in	10	51-36

General Purpose Bow Saws with Reversible Blade 24"



3-24-51



607 mm 24 in 5 3-24-51

Bow Saws for Ventilation Tubes 24"



14-24



607 mm 24 in 5 14-24-3810

Green Wood Spare Blades for Bow Saw 15"-36"



23



378 mm	13.33 in	10	23-15
530 mm	20.75 in	10	23-21
607 mm	24 in	10	23-24
759 mm	30 in	10	23-30
810 mm	28.57 in	10	23-32
912 mm	36 in	10	23-36



Fine Peg Toothed Spare Blades for Bow Saw 14³



333-5

350 mm	13-3/4 in	10	333-5

PRUNING SAWS

Toothed Handheld Pruning Saws with Low Friction Blade



349

300 mm	7	4	349

Foldable Pruning Saws with Low Friction Blade



PG-72

190 mm	7	4	PG-72

Foldable Pruning Saws with Dual-Component Handle for Dry Wood/Plastic/Bone Cutting



396-LAP

190 mm	200 g	10	396-LAP
190 mm	44 g	100	396-BLADE
190 mm	44 g	1	396-BLADE-1P

Foldable Pruning Saws with Dual-Component Handle for Green Branches Cutting



396-JS

190 mm	5	4	396-JS

Foldable Pruning Saws with Dual-Component Handle for Winter Pruning



396-JT

190 mm	7	4	396-JT

Foldable Pruning Saws with Dual-Component Handle for Hard/Dry Wood Cutting



396-HP

190 mm	7	4	396-HP

4211 Hardpoint and 4212 Fileable Toothed Pruning Saws with Wooden Handle



4211-/4212-

280 mm	6	4	4211-11-6T
360 mm	6	4	4211-14-6T
280 mm	6	4	4212-11-6T
360 mm	6	4	4212-14-6T

Handheld Pruning Saws with Dual-Component Handle and Holster for Green Branches Cutting



51-JS

240 mm	5	4	5124-JS-H
280 mm	5	4	5128-JS-H

Pruning Saws with Dual-Component Handle and Holster for Winter Pruning



41-JT

240 mm	7	4	4124-JT-H
280 mm	7	4	4128-JT-H

Foldable Saw and Knife Laplander Set with Dual-Component Handle



LAP-KNIFE



329 g	10	LAP-KNIFE

396-LAP		
2444-LAP		

Spare Blades for 51-JS Pruning Saws



5724-JS/5728-JS

240 mm	5	1	5724-JS
280 mm	5	1	5728-JS

Spare Blades for 41-JT Pruning Saws



4724-JT/4728-JT

240 mm	7	1	4724-JT
280 mm	7	1	4728-JT

Spare Blades for 396-JS Pruning Saws



396-JS-BLADE

190 mm	5	200	396-JS-BLADE

Spare Blades for 396-JT Pruning Saws



396-JT-BLADE

190 mm	7	200	396-JT-BLADE

Spare Blades for 396-HP Pruning Saws



396-HP-BLADE

190 mm	7	200	396-HP-BLADE

Spare Blades for 4211/4212/339/340 Pruning Saws



4400-/4420-

280 mm	6	10	4400-11
360 mm	6	10	4400-14
280 mm	6	10	4420-11

360 mm	6	10	4420-14
280 mm	6	10	4400-11-BULK
360 mm	6	10	4400-14-BULK
280 mm	6	10	4420-11-BULK
360 mm	6	10	4420-14-BULK

SPARE PARTS & ACCESSORIES

Spare Fine Cut Curved Blades for Pole Saws



AS-F-BLADE

330 mm	7	15	AS-C33-JT-F

Spare Medium Cut Curved Blades for Pole Saws



AS-M-BLADE

360 mm	6.2	15	AS-C36-JT-M

Spare Coarse Cut Curved Blades for Pole Saws



AS-C-C-BLADE

390 mm	5.4	15	AS-C39-JT-C
450 mm	5.4	15	AS-C45-JT-C



ACCESSORIES & MAINTENANCE

Synthetic Grinding Stones 180/400 Grain



LS-COMBINESS



100 mm



600 LS-COMBINESS

Synthetic Grinding Stones 180 Grain



LS-PIERRE-FAUX



230 mm



90 LS-PIERRE-FAUX

Synthetic Grinding Stones 320 Grain



LS-CORINDON



100 mm



1 LS-PIERRE CORINDON

Carbor Type Synthetic Grinding Stones
220 Grain



LS-6160-23



230 mm



90 LS-6160-23

Grinding Stones and Carbide Sharpener
with Dual-Component Handle



SHARP-X



100 mm
100 mm



10 SHARP-X
1 SHARP-X-DISP

Lubricants 50 ml Spray Bottle



LUB-2015



60 g



6 LUB-2015

Leather Secateurs Holsters



PROF-H



86 g



1 PROF-H

Nylon Lopper Holsters



PROF-LOPP



390 g



1 PROF-LOPP

Nylon Secateurs Holsters



PROF-SEC



150 g



1 PROF-SEC

PRUNING KNIVES

Foldable Grafting Knives with Plastic Handle



P11

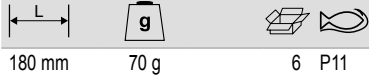

180 mm

70 g

6 P11

Foldable Pruning Knives with Plastic Handle



P20

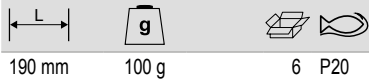

190 mm

100 g

6 P20

Bow-Shaped Foldable Pruning Knives with Stainless Steel Handle



K-AP-1



90 g

10 K-AP-1

Hook-Shaped Foldable Pruning Knives with Stainless Steel Handle



K-GP-1



90 g

10 K-GP-1



Air Tools Outdoor



SECATEURS

Professional Air Secateurs with Single Cutting Blade



9210

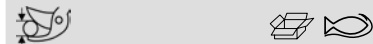

30 mm 1 9210

Cutting Blades and Rivets for 9210 Air Secateurs



9210-1



9210 82 g 1 9210-1

Complete Pre-Assembled Cutting Heads for 9210 Air Secateurs



9210-10



9210 212 g 1 9210-10

Pack of Assorted O-Rings for 9210 Air Secateurs



9210-20



9210 28 g 1 9210-20

Brass Sleeves for 9210 Air Secateurs - 10 Pcs



9210-1720100



9210 55.3 g 1 9210-1720100

Piston Seals for 9210 Air Secateurs



9210-1230235



9210 6.7 g 1 9210-1230235

Piston Discs for 9210 Air Secateurs



9210-1690148



9210 22 g 1 9210-1690148

Shock Absorbers for 9210 Air Secateurs



9210-1730107



9210 176 g 10 9210-1730107

Return Springs for 9210 Air Secateurs



9210-1640142



9210 26.6 g 1 9210-1640142

Connecting Rods for 9210 Air Secateurs



9210-1700118



9210 41 g 1 9210-1700118

TSP 2.2 mm x 6.5 mm Self Tapping Screws for 9210 Air Secateurs



9210-1060238



9210 10 g 20 9210-1060238

TCCE M6 x 20 mm Screws for 9210 Air Secateurs



9210-1060177



9210 7 g 1 9210-1060177

Special Rivets for 9210 Air Secateurs



9210-1770106



9210 1000 g 10 9210-1770106

Front Covers for 9210 Air Secateurs



9210-1830137



9210 9.5 g 1 9210-1830137

Hand Guards for 9210 Air Secateurs



9210-1320281



9210 35 g 10 9210-1320281

Dust Protection Seals for 9210 Air Secateurs



9210-1230219



9210 8.6 g 20 9210-1230219

Secateurs Body with Brass Cylinder for 9210 Air Secateurs



9210-1710266



9210 193 g 1 9210-1710266





BAHCO®



Lindström

▶ KITS & SETS

JEWELLERY KITS

Jewellery Kit with bi material ergonomic cutters and pliers



9061



1 9061

RX 8141		
RX 7893		
RX 7490		
RX 7590		

Jewellery Kit with mono material cutters and pliers



9060



1 9060

8141		
7893		
7490		
7590		

▶ SHEAR CUTTERS

TAPERED HEAD

Micro Edge Shear Cutter with Tapered Head



6151

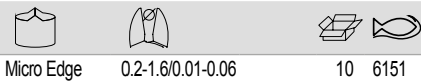

Micro Edge 0.2-1.6/0.01-0.06 10 6151

Flush Edge Shear Cutter with Tapered Head



6152



Flush Edge 0.2-1.6/0.01-0.06 10 6152

Stainless Steel Flush Edge Shear Cutter with Tapered Head



6152SS



Flush Edge 0.2-1.6/0.01-0.06 10 6152SS

POINTY HEAD

Flush Edge Shear Cutter with Pointy Head



6159



Flush Edge 0.2-1.0/0.01-0.039 10 6159

OBLIQUE HEAD

Flush Edge Shear Cutter with Oblique Head



6258



Flush Edge 0.2-1.0/0.01-0.039 10 6258

SHEAR CUTTERS SETS

Set of 3 shear cutters with tapered micro and flush edge cutting result and pointy version



EDGE-LAUNCH1



1 EDGE-LAUNCH1

6151		
6152		
6159		

PRECISION SCREWDRIVERS

ESD SAFE

Slotted ESD Safe Precision Screwdrivers
1.5-3.0 mm



800ESD



Tip Size	Length	Qty	Part No.
1.5 mm	50 mm	10	800-1.5-50ESD
2.0 mm	50 mm	10	800-2-50ESD
2.5 mm	50 mm	10	800-2.5-50ESD
3.0 mm	50 mm	10	800-3-50ESD

Phillips ESD Safe Precision Screwdrivers
PH00-PH1



801ESD



Tip Size	Length	Qty	Part No.
PH00	50 mm	10	801-00-50ESD
PH0	50 mm	10	801-0-50ESD
PH1	75 mm	10	801-1-75ESD

TORX® ESD Safe Precision Screwdrivers
T6-T20



803ESD



Tip Size	Length	Qty	Part No.
T6	50 mm	10	803-6-50ESD
T7	50 mm	10	803-7-50ESD
T8	50 mm	10	803-8-50ESD
T9	50 mm	10	803-9-50ESD
T10	50 mm	10	803-10-50ESD
T15	75 mm	10	803-15-75ESD
T20	75 mm	10	803-20-75ESD

Pentalobe ESD Safe Precision
Screwdrivers TS1-TS5



805ESD



Tip Size	Length	Qty	Part No.
TS1	50 mm	10	805-TS1-50ESD
TS4	50 mm	10	805-TS4-50ESD
TS5	50 mm	10	805-TS5-50ESD

Slotted/Phillips ESD Safe Precision
Screwdriver Set 1.5-3.0mm/PH00-PH1 - 7
Pcs



801-7ESD



Tip Size	Length	Qty	Part No.
PH00	50 mm	7	801-7ESD

800-1.5-50ESD, 800-2-50ESD, 800-2.5-50ESD, 800-3-50ESD

801-00-50ESD, 801-0-50ESD, 801-1-75ESD

TORX® ESD Safe Precision Screwdriver
Set T6-T20 - 7 Pcs



803-7ESD



Tip Size	Length	Qty	Part No.
T6	50 mm	7	803-7ESD

803-6-50ESD, 803-7-50ESD, 803-8-50ESD, 803-9-50ESD, 803-10-50ESD, 803-15-75ESD, 803-20-75ESD

HEAVY DUTY CUTTERS

DIAGONAL CUTTER

Heavy Duty Diagonal Cutters with Dual-Component Handle



TRX 8180

Tip Size	Length	Qty	Part No.
4.5 mm	2.5 mm	5	TRX 8180



PRECISION CUTTERS

DIAGONAL CUTTERS

ERGO™ Precision Diagonal Cutters with Oval Head



ergo



RX 8130-RX 8162



Size	Head Type	Quantity	Part No.
0.00-0.04 / 0.2-1.0	Micro-Bevel®	10	RX 8130
0.00-0.04 / 0.1-1.0	Flush	10	RX 8131
0.00-0.03 / 0.1-0.8	Ultra-Flush®	10	RX 8132
0.00-0.05 / 0.2-1.25	Micro-Bevel®	10	RX 8140
0.00-0.05 / 0.1-1.25	Flush	10	RX 8141
0.00-0.04 / 0.1-1.0	Ultra-Flush®	10	RX 8142
0.01-0.06 / 0.3-1.6	Micro-Bevel®	10	RX 8150
0.00-0.06 / 0.2-1.6	Flush	10	RX 8151
0.00-0.05 / 0.2-1.25	Ultra-Flush®	10	RX 8152
0.02-0.08 / 0.4-2.0	Micro-Bevel®	10	RX 8160
0.01-0.08 / 0.3-2.0	Flush	10	RX 8161
0.01-0.06 / 0.3-1.6	Ultra-Flush®	10	RX 8162

Precision Diagonal Cutters with Oval Head & ESD Safe Handle



8130-8162



Size	Head Type	Quantity	Part No.
0.01-0.04 / 0.2-1.0	Micro-Bevel®	10	8130
0.00-0.04 / 0.1-1.0	Flush	10	8131
0.00-0.03 / 0.1-0.8	Ultra-Flush®	10	8132
0.01-0.05 / 0.2-1.25	Micro-Bevel®	10	8140
0.00-0.05 / 0.1-1.25	Flush	10	8141
0.00-0.04 / 0.1-1.0	Ultra-Flush®	10	8142
0.01-0.06 / 0.3-1.6	Micro-Bevel®	10	8150
0.01-0.06 / 0.2-1.6	Flush	10	8151
0.00-0.05 / 0.1-1.25	Ultra-Flush®	10	8152
0.02-0.08 / 0.4-2.0	Micro-Bevel®	10	8160
0.01-0.08 / 0.3-2.0	Flush	10	8161

Size	Head Type	Quantity	Part No.
0.01-0.08 / 0.3-1.6	Ultra-Flush®	10	8162
0.00-0.04 / 0.1-1.0	Flush	10	8131 CO
0.01-0.05 / 0.2-1.25	Micro-Bevel®	10	8140 CO
0.00-0.05 / 0.1-1.25	Flush	10	8141 CO
0.00-0.04 / 0.1-1.0	Ultra-Flush®	10	8142 CO
0.01-0.06 / 0.3-1.6	Micro-Bevel®	10	8150 CO
0.01-0.06 / 0.2-1.6	Flush	10	8151 CO
0.02-0.08 / 0.4-2.0	Micro-Bevel®	10	8160 CO
0.01-0.08 / 0.3-2.0	Flush	10	8161 CO

ERGO™ Precision Diagonal Cutters with Tapered Head



ergo



RX 8133-RX 8165



Size	Head Type	Quantity	Part No.
0.008-0.04 / 0.2-1.0	Micro-Bevel®	10	RX8133
0.004-0.03 / 0.1-0.8	Flush	10	RX8134
0.01-0.05 / 0.2-1.25	Micro-Bevel®	10	RX 8143
0.00-0.05 / 0.1-1.25	Flush	10	RX 8144
0.00-0.04 / 0.1-1.0	Ultra-Flush®	10	RX 8145
0.01-0.06 / 0.3-1.6	Micro-Bevel®	10	RX 8153
0.01-0.06 / 0.2-1.6	Flush	10	RX 8154
0.01-0.05 / 0.2-1.25	Ultra-Flush®	10	RX8155
0.02-0.08 / 0.4-2.0	Micro-Bevel®	10	RX8163
0.01-0.08 / 0.3-2.0	Flush	10	RX 8164
0.01-0.06 / 0.3-1.6	Ultra-Flush®	10	RX 8165

Precision Diagonal Cutters with Tapered Head



8133-8165



Size	Head Type	Quantity	Part No.
0.008-0.04 / 0.2-1.0	Micro-Bevel®	10	8133
0.004-0.03 / 0.1-0.8	Flush	10	8134
0.004-0.02 / 0.1-0.5	Ultra-Flush®	10	8135
0.01-0.05 / 0.2-1.25	Micro-Bevel®	10	8143
0.01-0.05 / 0.2-1.25	Flush	10	8144
0.00-0.04 / 0.1-1.0	Ultra-Flush®	10	8145
0.01-0.06 / 0.3-1.6	Micro-Bevel®	10	8153
0.01-0.06 / 0.2-1.6	Flush	10	8154

Size	Head Type	Quantity	Part No.
0.01-0.05 / 0.2-1.25	Ultra-Flush®	10	8155
0.02-0.08 / 0.4-2.0	Micro-Bevel®	10	8163
0.01-0.08 / 0.3-2.0	Flush	10	8164
0.01-0.06 / 0.3-1.6	Ultra-Flush®	10	8165
0.01-0.05 / 0.2-1.25	Flush	10	8144 CO
0.01-0.06 / 0.2-1.6	Flush	10	8154 CO
0.02-0.08 / 0.4-2.0	Micro-Bevel®	10	8163 CO
0.01-0.06 / 0.3-1.6	Ultra-Flush®	10	8165 CO

Diagonal Cutters with Tapered Head & ESD Safe Handle



7190-7191



Size	Head Type	Quantity	Part No.
0.00-0.04 / 0.2-1.0	Micro-Bevel®	10	7190
0.00-0.04 / 0.1-1.0	Flush	10	7191
0.00-0.04 / 0.2-1.0	Micro-Bevel®	10	7190 CO
0.00-0.04 / 0.1-1.0	Flush	10	7191 CO

ERGO™ Precision Diagonal Cutters with Tapered & Relieved Head



ergo



RX 8136-RX 8168



Size	Head Type	Quantity	Part No.
0.004-0.03 / 0.1-0.8	Micro-Bevel®	10	RX8136
0.004-0.03 / 0.1-0.8	Flush	10	RX 8137
0.004-0.02 / 0.1-0.5	Ultra-Flush®	10	RX8138
0.01-0.04 / 0.2-1.0	Micro-Bevel®	10	RX 8146
0.00-0.04 / 0.1-1.0	Flush	10	RX 8147
0.00-0.03 / 0.1-0.8	Ultra-Flush®	10	RX 8148
0.01-0.05 / 0.3-1.25	Micro-Bevel®	10	RX 8156
0.01-0.05 / 0.2-1.25	Flush	10	RX 8157
0.01-0.04 / 0.2-1.0	Ultra-Flush®	10	RX 8158
0.02-0.06 / 0.4-1.5	Micro-Bevel®	10	RX8166
0.01-0.06 / 0.3-1.5	Flush	10	RX 8167
0.01-0.05 / 0.3-1.25	Ultra-Flush®	10	RX 8168

Precision Diagonal Cutters with Tapered Head & Relieved & ESD Safe Handle



8136-8168



0.004-0.03 / 0.1-0.8 Micro-Bevel®	10	8136
0.004-0.03 / 0.1-0.8 Flush	10	8137
0.004-0.02 / 0.1-0.5 Ultra-Flush®	10	8138
0.01-0.04 / 0.2-1.0 Micro-Bevel®	10	8146
0.01-0.04 / 0.1-1.0 Flush	10	8147
0.00-0.03 / 0.1-0.8 Ultra-Flush®	10	8148
0.01-0.05 / 0.3-1.25 Micro-Bevel®	10	8156
0.01-0.05 / 0.2-1.25 Flush	10	8157
0.01-0.04 / 0.2-1.0 Ultra-Flush®	10	8158
0.02-0.06 / 0.4-1.5 Micro-Bevel®	10	8166L
0.01-0.06 / 0.3-1.5 Flush	10	8167L
0.01-0.05 / 0.3-1.25 Ultra-Flush®	10	8168L
0.00-0.03 / 0.1-0.8 Ultra-Flush®	10	8148 CO

DIAGONAL CUTTERS, UNIQUE HEAD

ERGO™ Precision Diagonal Cutters with Tapered & Relieved Tip Head



RX8137MX-RX8138MX



0.1-0.8 mm Flush	10	RX8137MX
0.1-0.8 mm Ultra-Flush®	10	RX8138MX

OBLIQUE - END CUTTERS

Precision 11° Oblique End Head Cutters 0.35 mm-1.25 mm



7290-7291



0.01-0.03 / 0.35-0.8 Micro-Bevel®	10	7290
0.01-0.03 / 0.35-0.8 Flush	10	7291

Precision 11° Oblique End Miniature Head Cutters with Miniature Head



7292



0.01-0.03 / 0.35 Flush	10	7292
------------------------	----	------

Precision 11° Oblique End Short Head Cutters 0.35 mm-1 mm



7293



0.01-0.03 / 0.35-0.8 Flush	10	7293
----------------------------	----	------

ANGLE

ERGO™ Short Precision 20° Head Oblique Cutters 0.2 mm-1.2 mm



RX 8211



0.01-0.05 / 0.2-1.2 Flush	10	RX 8211
---------------------------	----	---------

Short Precision 20° Head Oblique Cutters 0.2 mm-1.2 mm



8211



0.01-0.05 / 0.2-1.2 Flush	10	8211
---------------------------	----	------

ERGO™ Long Precision 45° Tapered Head Oblique Cutters 0.2 mm-1 mm



RX 8247



0.01-0.04 / 0.2-1.0 Flush	10	RX 8247
---------------------------	----	---------

Precision 45° Head Oblique Cutters 0.2 mm-1 mm



8247



0.01-0.04 / 0.2-1.0	Flush	10	8247
0.01-0.04 / 0.2-1.0	Flush	10	8247 CO

Long Precision 45° Tapered & Relieved Head Oblique Cutters 0.2 mm-0.8 mm



8248



0.01-0.03 / 0.2-0.8	Flush	10	8248
0.00-0.03 / 0.2-0.8	Flush	10	8249
0.01-0.03 / 0.2-0.8	Flush	10	8248 CO

ERGO™ Long Precision 45° Tapered & Relieved Head Oblique Cutters 0.2 mm-0.8 mm



ergo



RX 8248



0.01-0.03 / 0.2-0.8	Flush	10	RX 8248

Precision 45° Reverse angle & HS Long 45° Reverse Angle Cutters 0.2 mm-08 mm



7280



0.01-0.03 / 0.2-08	Flush	10	7280

Precision 45° Oblique Cutters 0.2 mm-1 mm



7285



0.2-1.0 mm	Flush	10	7285

PLASTIC CUTTERS

ERGO™ Precision Diagonal Plastic Cutters



ergo



P6160

1.5 mm	Flush	10	P6160

TIP CUTTER

ERGO™ Precision Diagonal Tip Cutters



ergo



RX 8149



0.01-0.02 / 0.1-0.6	Flush	10	RX 8149

Precision Diagonal Tip Cutters with ESD Safe Handle



8149



0.00-0.02 / 0.1-0.6	Flush	10	8149

OBLIQUE CUTTERS, UNIQUE HEAD

45° Tapered & Relieved Extra Long Head Oblique Cutters with Unique Head 0.2 mm-0.8 mm



8248Q



0.00-0.03 / 0.2-0.8	Ultra-Flush®	10	8248Q

Precision Oblique End Cutters with Extra-Miniature Unique Head



7292G



0.01-0.03 / 0.35	Flush	10	7292G

MICRO TIP CUTTERS

ERGO™ Precision Micro Tip Cutters 149 mm



ergo



RX 8233



0.004-0.024 / 0.1-0.6	Flush	10	RX8233A

ERGO™ Precision Micro Tip Cutters 141 mm



ergo



RX 8234



0.002-0.018 / 0.05-0.4	Flush	10	RX8234A

ERGO™ Precision Micro Tip Cutters 144 mm



ergo



RX 8237



0.004-0.02 / 0.1-0.5	Flush	10	RX8237A

MULTIPURPOSE SHEARS

Multipurpose Shear with Non-Slip Grips



HS6000



Kevlar	Flush	10	HS6000
Kevlar	Flush	10	HS6001

ACCESSORIES & SPARE PARTS

Lead Catchers for 8130 & 8140 Series Diagonal Cutters



813/814/816

8130-8132, Rx 8130-8132	1	813
8140-8148, Rx 8140-8148	1	814
8130-8132, 8140-8148	1	816

Return Springs for RX Series



RX 01

5 g	1	RX 01

Return Springs for 80, Supreme and HS Series



8130-50/8160

1 g	1	8130-50/SUPR SPRING
1 g	1	8160/SPRING

PRECISION CUTTERS FOR HARD MATERIALS

CARBIDE CUTTERS

Precision Carbide Diagonal Cutters with Tapered Head for Hard Materials



7154 TC



0.1-0.9 mm 0.1-0.4 mm 10 7154TC

EXTRA HARDENED DIAGONAL CUTTERS

Precision Diagonal Cutters with Oval Head & ESD Safe Handle for hard materials



ergo



RX 8140M2-8160M2



0.01-0.05 / 0.4-2.0 Micro-Bevel® 10 RX8140M2
 0.01-0.06 / 0.4-2.0 Micro-Bevel® 10 RX8150M2
 0.02-0.08 / 0.4-2.0 Micro-Bevel® 10 RX8160M2

Precision Diagonal Cutters with Oval Head & ESD Safe Handle for hard materials



8140M2-8160M2



0.01-0.05 / 0.4-2.0 Micro-Bevel® 10 8140M2
 0.01-0.06 / 0.4-2.0 Micro-Bevel® 10 8150M2
 0.02-0.08 / 0.4-2.0 Micro-Bevel® 10 8160 M2

PERFORMANCE SPECIFIC DIAGONAL CUTTERS

Precision Diagonal Cutters with Tapered Head & ESD Safe Handle for hard materials



ergo



RX 8140PS-RX 8161PS



0.01-0.04 / 0.1-1.0 Micro-Bevel® 10 RX8140PS
 0.01-0.04 / 0.1-1.0 Flush 10 RX8141PS
 0.01-0.04 / 0.1-1.0 Micro-Bevel® 10 RX 8142PS
 0.01-0.04 / 0.1-1.0 Micro-Bevel® 10 RX8150PS
 0.01-0.06 / 0.3-1.6 Flush 10 RX 8161PS

Precision Diagonal Cutters with Oval Head & ESD Safe Handle for hard materials



8140PS-8161PS



0.01-0.04 / 0.1-1.0 Micro-Bevel® 10 8140PS
 0.01-0.04 / 0.1-1.0 Flush 10 8141PS
 0.00-0.05 / 0.1-1.25 Micro-Bevel® 10 8150PS
 0.01-0.06 / 0.3-1.6 Micro-Bevel® 10 8160PS
 0.01-0.06 / 0.3-1.6 Flush 10 8161PS

Precision Diagonal Cutters with Tapered Head & ESD Safe Handle for hard materials



ergo



RX8143PS-RX 8147PS



0.01-0.04 / 0.1-1.0 Flush 10 RX8143PS
 0.004-0.03 / 0.1-0.8 Flush 10 RX 8147PS

PERFORMANCE SPECIFIC DIAGONAL CUTTERS, UNIQUE HEAD

ERGO™ Performance Specific Diagonal Cutters with Oval Unique Head & Relieved Tip



ergo



RX8140PSF-RX8160BPS



0.01-0.04 / 0.1-1.0 Micro-Bevel® 10 RX8160BPS

Precision Performance Specific Diagonal Cutters with Oval Head



8154PSP



0.00-0.05 in Micro-Bevel® 10 8154PSP

PRECISION HOLDING PLIERS

FLAT NOSE

Flat Nose Pliers with Dual-Component Synthetic Handle



7490

20 mm	S	10	7490
20 mm	S	10	7490 CO

Round Nose Tipped Pliers with Synthetic Handle



7590-7591

20 mm	S	10	7590
20 mm	S	10	7590 CO
38.5 mm	M	1	7591

Snipe Nose Pliers with Dual-Component Synthetic Handle



7890-7891

32.5 mm	M	10	7890
32.5 mm	M	10	7891
32.5 mm	M	10	7890 CO
32.5 mm	M	10	7891 CO

ERGO™ Precision Flat Nose Pliers with Dual-Component Synthetic Handle



ergo



RX 7490

20 mm	S	10	RX 7490

ERGO™ 60° Bent Tip Snipe Nose Pliers with Dual-Component Synthetic Handle



ergo



RX 7892

29 mm	M	10	RX 7892

CHAINMAILLE PLIER

ERGO™ Precision Chainmaille Flat Straight Nose Stubby Pliers with Synthetic Handle



ergo



RX 7390

11 mm	S	10	RX 7390

ROUND NOSE

ERGO™ Precision Round Nose Pliers with Dual-Component Synthetic Handle



ergo



RX 7590

20 mm	S	10	RX 7590

ERGO™ Snipe Nose Pliers with Dual-Component Synthetic Handle



ergo



RX 7890-RX 7891

32 mm	S	10	RX 7890
32 mm	S	10	RX 7891

ERGO™ Precision Chainmaille Flat Oblique Nose Stubby Pliers with Synthetic Handle



ergo



RX 7392

12 mm	S	10	RX 7392

BENT NOSE

60° Bent Tip Snipe Nose Pliers with Synthetic Handle



7892



20 mm	M	10	7892
20 mm	M	10	7892 CO

SNIPE NOSE, UNIQUE HEAD

Short Serrated Snipe Nose Pliers with Synthetic Handle



7893K



20 mm	S	10	7893K

SNIPE NOSE

ERGO™ Short Snipe Nose Pliers with Dual-Component Synthetic Handle



ergo®



RX 7893



20 mm	S	10	RX 7893

NEEDLE NOSE

ERGO™ Precision Needle Nose Holding Pliers with smooth Jaws



ergo®



RX 7894



L		10	RX 7894

Short Snipe Nose Pliers with Synthetic Handle



7893



20 mm	S	10	7893

Precision Needle Nose Holding Pliers with smooth Jaws & ESD Safe Handle



7894



L		10	7894

WIRE STRIPPERS

DIAGONAL CUTTERS

Precision Diagonal Cutters with Oval Head - Stripping Accessory & ESD Safe Handle



8150SK



0.01-0.06 / 0.3-1.6	Micro-Bevel®	10	8150 SK

Precision Diagonal Wire Strippers & Cutters with Oval Head & ESD Safe Handle



8150J-8160J



0.02 / 0.5	Micro-Bevel®	10	8150 J
Max0.02 / Max	Micro-Bevel®	10	8160 J

TORQUE TOOLS

TORQUE SCREWDRIVERS

Adjustable Torque Screwdrivers with Window Scale and ESD Safe



MA500-1A - MA500-3A

Scale	Bit Size	Quantity	Model
16-80 cNM	1/4 in	1	MA500-1A
40-200 cNM	1/4 in	1	MA500-2A
90-450 cNM	1/4 in	1	MA500-3A

Pre-Set Torque Screwdrivers with Window Scale and ESD Safe



PS501

Scale	Bit Size	Quantity	Model
4-22 cNM	1/4 in	1	PS501-1
7-70 cNM	1/4 in	1	PS501-2
15-170 cNM	1/4 in	1	PS501-3
45-450 cNM	1/4 in	1	PS501-4

TWEEZERS

TWEEZER SETS

Set of 5 Tweezers Tip Style SS-SA, 2A-SA, 7A-SA, AA-SA



9855

10 x 200 x 110 mm	1	9855
-------------------	---	------

9855W

TL SS-SA-SL	
TL AA-SA-SL	
TL 2A-SA-SL	
TL 7A-SA-SL	
TL 4-SA-SL	

Set of 5 Tweezers Tip Style 00-SA, 1-SA, 3C-SA, 5-SA, 7-SA



9857

10 x 200 x 110 mm	1	9857
-------------------	---	------

TL 00-SA-SL	
TL 1-SA-SL	
TL 5-SA-SL	
TL 7-SA-SL	
TL 3C-SA-SL	
9855W	

Set of 2 Tweezers Tip Style AA-SA, SS-SA



9858

8 x 200 x 65 mm	1	9858
-----------------	---	------

9858W

TL AA-SA-SL	
TL SS-SA-SL	

Set of 2 Tweezers Tip Style 00B-SA, 2A-SA



9859

8 x 200 x 65 mm	1	9859
-----------------	---	------

9858W

TL 00B-SA	
TL 2A-SA-SL	

Set of 5 High Precision Tweezers Tip Style 00-SA, 2A-SA, 3C-SA, 5-SA, 7-SA



9860

12 x 105 x 185 mm	1	9860
-------------------	---	------

Set of 5 Economy Tweezers Tip Style 00-SA, 2A-SA, 3C-SA, 5-SA, 7-SA



9861



10 x 70 x 165 mm



1 9861

Set of 4 Economy Tweezers Tip Style 2A-SA, 3C-SA, 7A-SA, AA-SA



9862



10 x 70 x 165 mm



1 9862

Set of 5 SMD and Economy Tweezers Tip Style SM103-SA, SM108-SA, 3-SA, 5-SA, 7A-SA



9863



10 x 70 x 165 mm



1 9863

CUTTING TWEEZERS

Carbon Steel Cutting Tweezers Style 15A with Angled Blades



TL 15A



15A



120 mm



1 TL 15A

Carbon Steel Cutting Tweezers Style 15AGW with Predominantly Angled Blades



TL 15AGW



15AGW



115 mm



1 TL 15AGW

Stainless Steel Cutting Tweezers Style 15AGWHM with Tungsten Carbide Inserts and Predominantly Angled Blades



TL 15AGWHM-SA



15AGHM



115 mm



1 TL 15AGWHM-SA

HIGH PRECISION TWEEZERS

Stainless Steel High Precision Tweezers Style 00B with Serrated Handles and Thick, Strong tips



TL 00B-SA



00B



120 mm



1 TL 00B-SA

Stainless steel, anti-magnetic, anti-acid

Stainless Steel High Precision Tweezers Style 00D with Serrated Handles and Thick, Strong, Linearly Serrated Tips



TL 00D-SA



00D



120 mm



1 TL 00D-SA

Stainless steel, anti-magnetic, anti-acid

Stainless Steel High Precision Tweezers Style 00 with Thick and Strong Tips



TL 00-SA



00



120 mm



1 TL 00-SA

Stainless steel, anti-magnetic, anti-acid

Stainless Steel High Precision Tweezers
Style 000 with Fine Tips



TL 000-SA

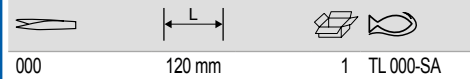

000 120 mm 1 TL 000-SA

Stainless steel, anti-magnetic, anti-acid

Stainless Steel High Precision Tweezers
Style 2A with Very Fine, Round and Flat
Tips



TL 2A-SA

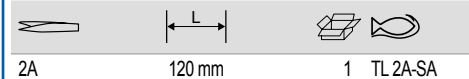

2A 120 mm 1 TL 2A-SA

Stainless steel, anti-magnetic, anti-acid

Stainless Steel High Precision Tweezers
Style 51S with Bent and Very Fine Tips



TL 51S-SA

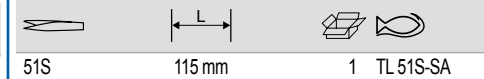

51S 115 mm 1 TL 51S-SA

Stainless steel, anti-magnetic, anti-acid

Stainless Steel High Precision Tweezers
Style 0C9 with Fine and Sharp Tips



TL 0C9-SA

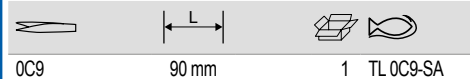

0C9 90 mm 1 TL 0C9-SA

Stainless steel, anti-magnetic, anti-acid

Stainless Steel High Precision Tweezers
Style 3C with Fine and Pointed Tips



TL 3C-SA

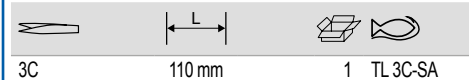

3C 110 mm 1 TL 3C-SA

Stainless steel, anti-magnetic, anti-acid

Stainless Steel High Precision Tweezers
Style 5 with Very Fine Sharp Tips



TL 5-SA

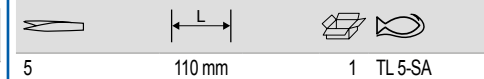

5 110 mm 1 TL 5-SA

Stainless steel, anti-magnetic, anti-acid

Stainless Steel High Precision Tweezers
Style 1 with Fine and Sharp Tips



TL 1-SA



1 120 mm 1 TL 1-SA

Stainless steel, anti-magnetic, anti-acid

Stainless Steel High Precision Tweezers
Style 3 with Fine and Pointed Tips



TL 3-SA



3 120 mm 1 TL 3-SA

Stainless steel, anti-magnetic, anti-acid

Stainless Steel High Precision Tweezers
Style SS with Very Fine and Very Sharp
Tips



TL SS-SA

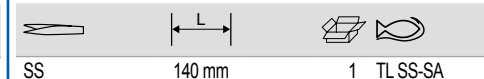

SS 140 mm 1 TL SS-SA

Stainless steel, anti-magnetic, anti-acid



Stainless Steel High Precision Tweezers
Style 7A with Very Fine and Curved Tips



TL 7A-SA

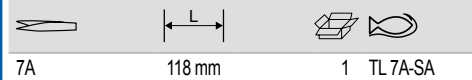

7A 118 mm 1 TL 7A-SA

Stainless steel, anti-magnetic, anti-acid

Stainless Steel High Precision Tweezers
Style 7 with Very Fine and Curved Tips



TL 7-SA

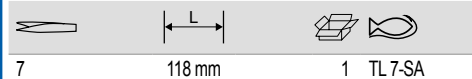

7 118 mm 1 TL 7-SA

Stainless steel, anti-magnetic, anti-acid

Stainless Steel High Precision Tweezers
Style 5B with Bent, Very Fine Sharp Tips



TL 5B-SA

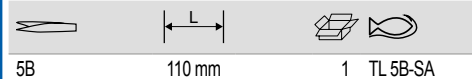

5B 110 mm 1 TL 5B-SA

Stainless steel, anti-magnetic, anti-acid

Stainless Steel High Precision Tweezers
Style 65A with Bent, Very Fine and Very
Sharp Tips



TL 65A-SA

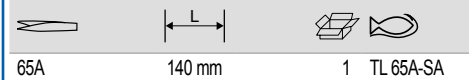

65A 140 mm 1 TL 65A-SA

Stainless steel, anti-magnetic, anti-acid

Stainless Steel High Precision Tweezers
Style 34A with Serrated Handles and
Smooth, Thin, Squared, Flat Tips



TL 34A-SA

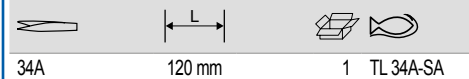

34A 120 mm 1 TL 34A-SA

Stainless Steel High Precision Tweezers
Style 6 with Angled and Very Fine Tips



TL 6-SA

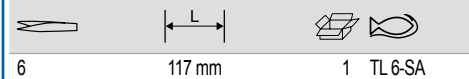

6 117 mm 1 TL 6-SA

PLASTIC REPLACEABLE TIP TWEEZERS

Carbon Fibre Plastic Replaceable Tip ESD
Safe Tweezers Style 242CFR with Fine
Tips



TL 242CFR-SA

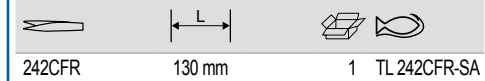

242CFR 130 mm 1 TL 242CFR-SA

Carbon Fibre Plastic Replaceable Tip ESD
Safe Tweezers Style 249CFR with Thick,
Beveled and Strong Tips



TL 249CFR-SA

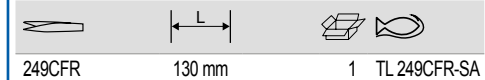

249CFR 130 mm 1 TL 249CFR-SA

Stainless steel body and carbon fibre tips

Carbon Fibre Plastic Replaceable Tip ESD
Safe Tweezers Style 259CFR with Fine,
Pointed and Strong Tips



TL 259CFR-SA

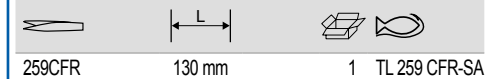

259CFR 130 mm 1 TL 259CFR-SA

Stainless steel body and carbon fibre tips

Carbon PEEK Plastic Replaceable Tip ESD Safe Tweezers Style 259CPR with Fine, Pointed and Strong Tips



TL 259CPR-SA



259CPR 130 mm 1 TL 259CPR-SA

Carbon Fibre Plastic Replaceable Tip ESD Safe Tweezers Style 2ACFR with Very Fine and Round Flat Tips



TL 2ACFR-SA



2ACFR 130 mm 1 TL 2ACFR-SA

Stainless steel body and carbon fibre tips

Carbon PEEK Plastic Replaceable Tip ESD Safe Tweezers Style 5CPR with Very Fine and Sharp Tips



TL 5CPR-SA

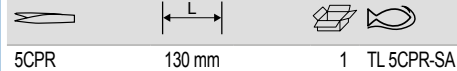

5CPR 130 mm 1 TL 5CPR-SA

Carbon Fibre Plastic Replaceable Tip ESD Safe Tweezers Style 00CFR with Thick and Squared Tips



TL 00CFR-SA



00CFR 130 mm 1 TL 00CFR-SA

Stainless steel body and carbon fibre tips

Carbon Fibre Plastic Replaceable Tip ESD Safe Tweezers Style 5CF with Very Fine and Sharp Tips



TL 5CF-SA



5CF 130 mm 1 TL 5CF-SA

PVDF Plastic Replaceable Tip ESD Safe Tweezers Style 5SV with Very Fine and Sharp Tips



TL 5SVR-SA

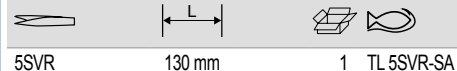

5SVR 130 mm 1 TL 5SVR-SA

PVDF Plastic Replaceable Tip ESD Safe Tweezers Style 259SVR with Fine, Pointed and Strong Tips



TL 259SVR-SA



259SVR 130 mm 1 TL 259SVR-SA

Carbon Fibre Plastic Replaceable Tip ESD Safe Tweezers Style 5CFR with Very Fine and Sharp Tips



TL 5CFR-SA



5CFR 130 mm 1 TL 5CFR-SA

Stainless steel body and carbon fibre tips

Carbon PEEK Plastic Replaceable Tip ESD Safe Tweezers Style 7CPR with Very Fine and Curved Tips



TL 7CPR-SA



7CPR 130 mm 1 TL 7CPR-SA

PVDF Plastic Replaceable Tip ESD Safe Tweezers Style 7SVR with Very Fine and Curved Tips



TL 7SVR-SA

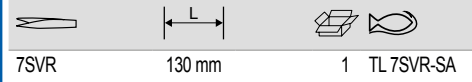

7SVR 130 mm 1 TL 7SVR-SA

Carbon Fibre Plastic Replaceable Tip ESD Safe Tweezers Style 7CFR with Very Fine and Curved Tips



TL 7CFR-SA

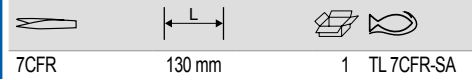

7CFR 130 mm 1 TL 7CFR-SA

Stainless steel body and carbon fibre tips



ESD SAFE ERGONOMIC TOUCH TWEEZERS

Stainless Steel ESD Safe Ergonomic Tweezers Style 00 with Thick and Strong Tips



TL 00-SA-ET

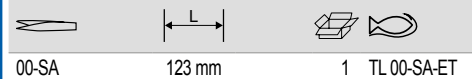

00-SA 123 mm 1 TL 00-SA-ET



Stainless Steel ESD Safe Ergonomic Tweezers Style 2A with Round, Flat and Very Fine Tips



TL 2A-SA-ET

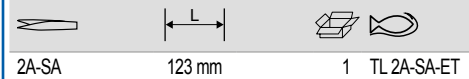

2A-SA 123 mm 1 TL 2A-SA-ET

Stainless Steel ESD Safe Ergonomic Tweezers Style 5 with Sharp and Fine Tips



TL 5-SA-ET

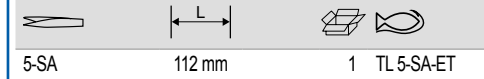

5-SA 112 mm 1 TL 5-SA-ET

Stainless Steel ESD Safe Ergonomic Tweezers Style 3 with Pointed and Fine Tips



TL 3-SA-ET

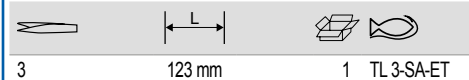

3 123 mm 1 TL 3-SA-ET



Stainless Steel ESD Safe Ergonomic Tweezers Style AA with Sharp, Fine Tips



TL AA-SA-ET

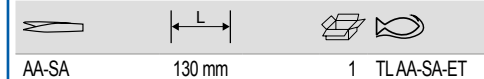

AA-SA 130 mm 1 TL AA-SA-ET

Stainless Steel ESD Safe Ergonomic Tweezers Style 3C with Pointed and Fine Tips



TL 3C-SA-ET

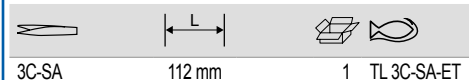

3C-SA 112 mm 1 TL 3C-SA-ET

Stainless Steel ESD Ergonomic Tweezers Style SM116 with Grooved Tips for Positioning Vertical Cylindrical Devices



TL SM116-SA-ET



SM116 115 mm 1 TL SM116-SA-ET

Stainless Steel ESD Safe Ergonomic Tweezers Style 7A with Curved and Fine Tips



TL 7A-SA-ET



7A 122 mm 1 TL 7A-SA-ET

Stainless Steel Economy Tweezers Style 1 with Sharp and Fine Tips



TL 1-SA-SL



1 120 mm 5 TL 1-SA-SL

Stainless Steel Economy Tweezers Style 3C with Pointed and Fine Tips



TL 3C-SA-SL

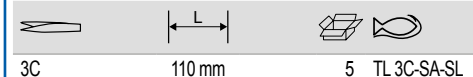

3C 110 mm 5 TL 3C-SA-SL

Stainless Steel ESD Safe Ergonomic Tweezers Style 7 with Curved, Very Fine Tips



TL 7-SA-ET

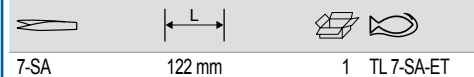

7-SA 122 mm 1 TL 7-SA-ET

Stainless Steel Economy Tweezers Style 2A with Flat and Fine Round Tips



TL 2A-SA-SL



2A 118 mm 5 TL 2A-SA-SL

Stainless Steel Economy Tweezers Style 3 with Pointed and Fine Tips



TL 3-SA-SL

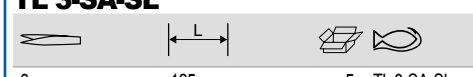

3 125 mm 5 TL 3-SA-SL

ECONOMY TWEEZERS

Stainless Steel Economy Tweezers Style 00 with Thick and Strong Tips



TL 00-SA-SL

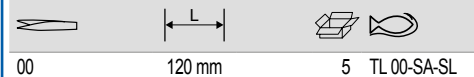

00 120 mm 5 TL 00-SA-SL

Stainless Steel Economy Tweezers Style 2 with Pointed and Very Fine Tips



TL 2-SA-SL



2 120 mm 5 TL 2-SA-SL

Stainless Steel Economy Tweezers Style 4 with Sharp and Fine Tips



TL 4-SA-SL

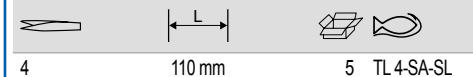

4 110 mm 5 TL 4-SA-SL

Stainless Steel Economy Tweezers Style 5A with Sharp and Fine Tips



TL 5A-SA-SL

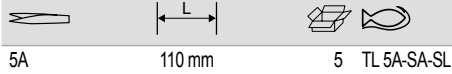

5A 110 mm 5 TL 5A-SA-SL

Stainless Steel Economy Tweezers Style SS with Very Sharp and Fine Tips



TL SS-SA-SL

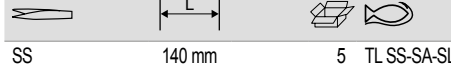

SS 140 mm 5 TL SS-SA-SL

Stainless Steel Economy Tweezers Style 7A with Curved and Fine Tips



TL 7A-SA-SL

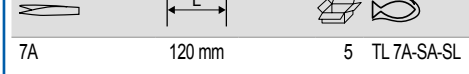

7A 120 mm 5 TL 7A-SA-SL

Stainless Steel Economy Tweezers Style 5A with Sharp and Fine Tips



TL 5-SA-SL

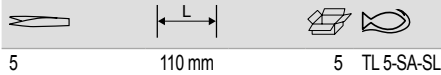

5 110 mm 5 TL 5-SA-SL

Stainless Steel Economy Tweezers Style AA with Sharp and Fine Tips



TL AA-SA-SL



AA 128 mm 5 TL AA-SA-SL

Stainless Steel Economy Tweezers Style 7 with Curved and Fine Tips



TL 7-SA-SL

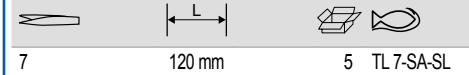

7 120 mm 5 TL 7-SA-SL

Stainless Steel Economy Tweezers Style AC with Serrated Handles and Strong Tips



TL AC-SA-SL

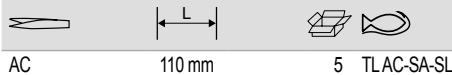

AC 110 mm 5 TL AC-SA-SL

Stainless Steel Economy Tweezers Style MM with Pointed, Strong and Fine Tips



TL MM-SA-SL

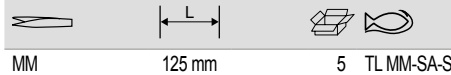

MM 125 mm 5 TL MM-SA-SL

SMD TWEEZERS

Stainless Steel SMD Tweezers Style SMD 104 for Positioning SOT Packages and Monolithic Chip Capacitors



TL SM104-SA

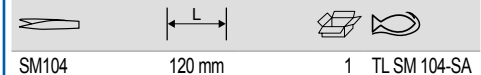

SM104 120 mm 1 TL SM 104-SA

Stainless steel, anti-magnetic, anti-acid

Stainless Steel SMD Tweezers Style SMD 105 with Hammer Shaped Tips for Positioning Vertical SOT Packages



TL SM105-SA

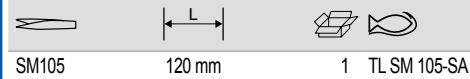

SM105 120 mm 1 TL SM 105-SA

Stainless steel, anti-magnetic, anti-acid

Stainless Steel SMD Tweezers Style SMD 109 for Soldering 1mm Wide Components at 45° Angle



TL SM109-SA

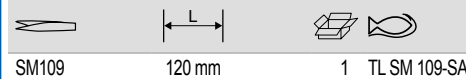

SM109 120 mm 1 TL SM 109-SA

Stainless steel, anti-magnetic, anti-acid

Stainless Steel SMD Tweezers Style SMD 116 with Grooved Tips for Positioning Vertical Cylindrical Devices



TL SM116-SA

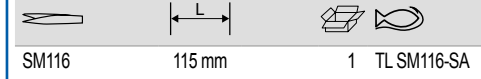

SM116 115 mm 1 TL SM 116-SA

Stainless Steel SMD Tweezers Style SMD 106 with Fine Shaped Tips for Positioning Horizontal SOT Packages



TL SM106-SA

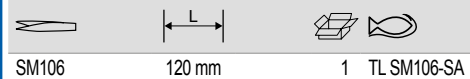

SM106 120 mm 1 TL SM 106-SA

Stainless steel, anti-magnetic, anti-acid

Stainless Steel SMD Tweezers Style SMD 110 with Grooved Tips for Positioning Cylindrical Devices



TL SM110-SA

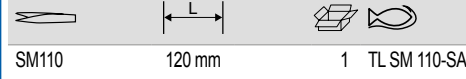

SM110 120 mm 1 TL SM 110-SA

Stainless steel, anti-magnetic, anti-acid

Stainless Steel SMD Tweezers Style SMD 107 with Double Bent Tips for Positioning Flat Devices



TL SM107-SA

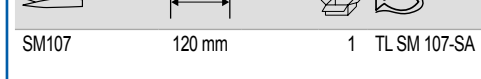

SM107 120 mm 1 TL SM 107-SA

Stainless steel, anti-magnetic, anti-acid

Stainless Steel SMD Tweezers Style SMD 108 for Soldering 1mm Wide Components



TL SM108-SA

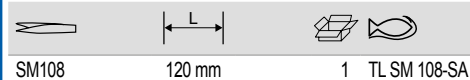

SM108 120 mm 1 TL SM 108-SA

Stainless steel, anti-magnetic, anti-acid

Stainless Steel SMD Tweezers Style SMD 111 with Grooved Tips for Positioning 0.5mm Cylindrical Devices



TL SM111-SA

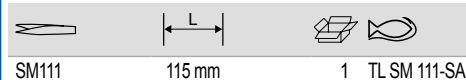

SM111 115 mm 1 TL SM 111-SA

Stainless steel, anti-magnetic, anti-acid

Stainless Steel SMD Tweezers Style SMD 103 for Handling and Positioning at a 45° Angle



TL SM103-SA

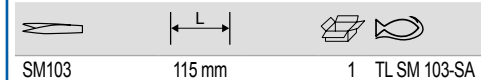

SM103 115 mm 1 TL SM 103-SA

Stainless steel, anti-magnetic, anti-acid



Stainless Steel SMD Tweezers Style SMD 115 with 45° Angled Grooved Tips for Positioning 0.6mm Cylindrical Devices



TL SM115-SA

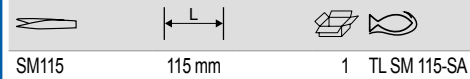

SM115 115 mm 1 TL SM 115-SA

Stainless steel, anti-magnetic, anti-acid

Stainless Steel SMD Tweezers Style SMD 117 with 20° Angled Squared Tips for Positioning SOT Packages



TL SM117-SA

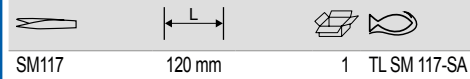

SM117 120 mm 1 TL SM 117-SA

Stainless steel, anti-magnetic, anti-acid

Stainless Steel Component Positioning Tweezers Style 582 with Serrated Handles and Grooved Tips for 1 mm Cylindrical Devices



TL 582-SA

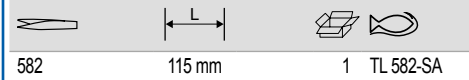

582 115 mm 1 TL 582-SA

Stainless steel, anti-magnetic, anti-acid

Stainless Steel General Purpose Tweezers Style 124 with Serrated Handles and Bent, Rhombic Serrated, Fine Tips



TL 124-SA

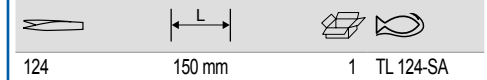

124 150 mm 1 TL 124-SA

Stainless steel, anti-magnetic, anti-acid

GENERAL PURPOSE TWEEZERS

Stainless Steel General Purpose Tweezers Style 475 with Serrated Handles and Beveled, Strong, Linearly Serrated Tips



TL 475-SA

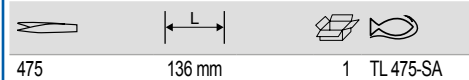

475 136 mm 1 TL 475-SA

Stainless steel, anti-magnetic, anti-acid

Stainless Steel General Purpose Tweezers Style 649 with Serrated Handles and Bent, Beveled, Thick, Strong, Linearly Serrated Tips



TL 649-SA

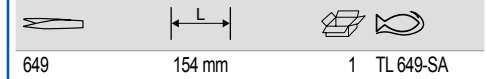

649 154 mm 1 TL 649-SA

Stainless steel, anti-magnetic, anti-acid

COMPONENTS POSITIONING TWEEZERS

Stainless Steel Component Positioning Tweezers Style 578 with Serrated Handles and Grooved Tips for 2 mm Cylindrical Devices



TL 578-SA

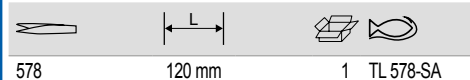

578 120 mm 1 TL 578-SA

Stainless steel, anti-magnetic, anti-acid

Stainless Steel General Purpose Tweezers Style 648 with Serrated Handles and Beveled, Thick, Strong, Sharp, Linearly Serrated Tips



TL 648-SA

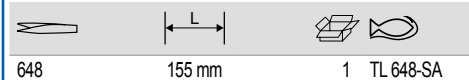

648 155 mm 1 TL 648-SA

Stainless steel, anti-magnetic, anti-acid

SPARE PARTS & ACCESSORIES

Set of 2 Carbon Fibre Tips and 3 Screws with Straight, Thick and Strong Tips TL 00CFR-SA



TL 00ACF

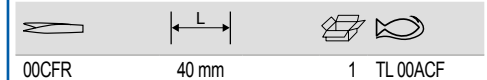

00CFR 40 mm 1 TL 00ACF

Set of 2 Carbon Fibre Tips and 3 Screws with Straight, Very Fine, Round and Flat Tips for TL 2ACFR-SA-TL 2AXCFR-SA



TL 2AACF



2A 40 mm 1 TL 2AACF

Set of 2 Carbon PEEK Tips and 3 Screws with Straight, Fine, Pointed and Strong Tips for TL 259CPR-SA



TL 259ACP

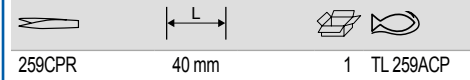

259CPR 40 mm 1 TL 259ACP

Set of 2 PVDF Tips and 3 Screws and Straight, Very Fine and Sharp Tips for TL 5SVR-SA-TL 5XSVR-SA



TL 5ASV

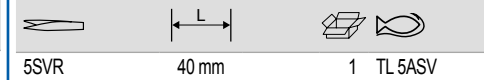

5SVR 40 mm 1 TL 5ASV

Set of 2 Carbon Fibre Tips and 3 Screws with Straight and Fine Tips for TL 242CFR-SA



TL 242ACF

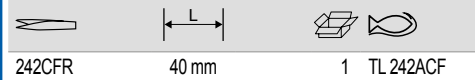

242CFR 40 mm 1 TL 242ACF

Set of 2 PVDF Tips and 3 Screws with Straight, Fine, Pointed and Strong Tips for TL 259SVR-SA



TL 259ASV

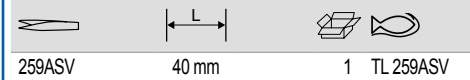

259ASV 40 mm 1 TL 259ASV

Set of 2 Carbon Fibre Tips and 3 Screws with Straight, Very Fine and Sharp Tips for TL 5CFR-SA-TL 5XCFR-SA



TL 5ACF

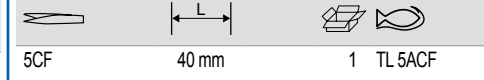

5CF 40 mm 1 TL 5ACF

Set of 2 Carbon Fibre Tips and 3 Screws with Straight, Thick, Beveled and Strong Tips for TL 249CFR-SA



TL 249ACF

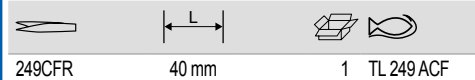

249CFR 40 mm 1 TL 249ACF

Set of 2 Carbon Fibre Tips and 3 Screws with Straight, Fine, Pointed and Strong Tips for TL 259CFR-SA



TL 259ACF

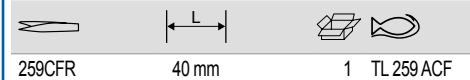

259CFR 40 mm 1 TL 259ACF

Set of 2 Carbon Fibre Tips and 3 Screws with Curved and Very Fine Tips for TL 7CFR-SA



TL 7ACF

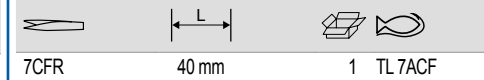

7CFR 40 mm 1 TL 7ACF



Set of 2 PVDF Tips and 3 Screws with Curved and Very Fine Tips for TL 7SVR-SA



TL 7ASV

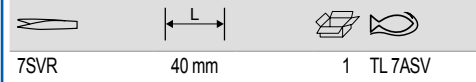

7SVR

40 mm

1 TL 7ASV

Set of 2 Carbon PEEK Tips and 3 Screws with Straight, Very Fine and Sharp Tips for TL 5CPR-SA-TL 5XCPR-SA



TL 5ACP

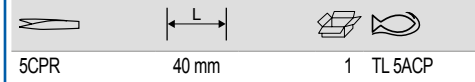

5CPR

40 mm

1 TL 5ACP

Set of 2 Carbon PEEK tips and 3 Screws with Curved and Very Fine Tips for TL 7CPR-SA



TL 7ACP

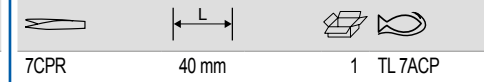

7CPR

40 mm

1 TL 7ACP



1-100-04-1-0	7311518019006	10	24
1-100-04-1-2	7311518244125	5	24
1-100-04-2-0	7311518019013	10	24
1-100-04-2-2	7311518244132	5	24
1-100-04-3-0	7311518019020	10	24
1-100-06-1-0	7311518019037	10	24
1-100-06-1-2	7311518000233	5	24
1-100-06-2-0	7311518019044	10	24
1-100-06-2-2	7311518003593	5	24
1-100-06-3-0	7311518019051	10	24
1-100-06-3-2	7311518293581	5	24
1-100-08-1-0	7311518019068	10	24
1-100-08-1-2	7311518000264	5	24
1-100-08-2-0	7311518019075	10	24
1-100-08-2-2	7311518003609	5	24
1-100-08-3-0	7311518019082	10	24
1-100-08-3-2	7311518295585	5	24
1-100-10-1-0	7311518019099	10	24
1-100-10-1-2	7311518000295	5	24
1-100-10-2-0	7311518019105	10	24
1-100-10-2-2	7311518003616	5	24
1-100-10-3-0	7311518019112	10	24
1-100-10-3-2	7311518295592	5	24
1-100-12-1-0	7311518019129	5	24
1-100-12-1-2	7311518028053	5	24
1-100-12-2-0	7311518019136	5	24
1-100-12-2-2	7311518244118	5	24
1-100-12-3-0	7311518019143	5	24
1-100-12-3-2	7311518295608	5	24
1-100-14-1-0	7311518019150	5	24
1-100-14-2-0	7311518019167	5	24
1-102-06-2-0	7311518019198	10	24
1-102-06-3-0	7311518019204	10	24
1-102-08-1-0	7311518019211	10	24
1-102-08-2-0	7311518019228	10	24
1-102-08-3-0	7311518019235	10	24
1-104-10-2-0	7311518019242	10	24
1-104-10-3-0	7311518019259	10	24
1-104-12-2-0	7311518019266	5	24
1-104-12-3-0	7311518019273	5	24
1-104-14-3-0	7311518019297	5	24
1-106-08-1-0	7311518019303	10	24
1-106-08-1-2	7311518000301	5	24
1-106-10-1-0	7311518019310	10	24
1-106-10-1-2	7311518000325	5	24
1-106-12-1-0	7311518019327	5	24
1-106-12-1-2	7311518295615	5	24
1-110-04-1-0	7311518019334	10	24
1-110-04-2-0	7311518019341	10	24
1-110-04-3-0	7311518044046	10	24
1-110-06-1-0	7311518019358	10	24
1-110-06-1-2	7311518295622	5	24
1-110-06-2-0	7311518019365	10	24
1-110-06-2-2	7311518003623	5	25
1-110-06-3-0	7311518019372	10	24
1-110-06-3-2	7311518295639	5	25
1-110-08-1-0	7311518019389	10	24
1-110-08-1-2	7311518000332	5	25
1-110-08-2-0	7311518019396	10	24
1-110-08-2-2	7311518003630	5	25
1-110-08-3-0	7311518019402	10	24
1-110-08-3-2	7311518295646	5	25
1-110-10-1-0	7311518019419	10	24
1-110-10-1-2	7311518000349	5	25
1-110-10-2-0	7311518019426	10	24
1-110-10-2-2	7311518003647	5	25
1-110-10-3-0	7311518019433	10	24
1-110-10-3-2	7311518295653	5	25
1-110-12-1-0	7311518019440	5	24
1-110-12-1-2	7311518295660	5	25
1-110-12-2-0	7311518019457	5	24
1-110-12-2-2	7311518295677	5	25
1-110-12-3-0	7311518019464	5	24
1-110-12-3-2	7311518295684	5	25
1-110-14-1-0	7311518019488	5	24
1-111-04-1-0	7311518044053	10	25
1-111-04-2-0	7311518019518	10	25
1-111-04-3-0	7311518019525	10	25
1-111-06-1-0	7311518019549	10	25
1-111-06-2-0	7311518019556	10	25
1-111-06-2-2	7311518000363	5	25
1-111-06-3-0	7311518019563	10	25
1-111-08-1-0	7311518019570	10	25
1-111-08-2-0	7311518019587	10	25
1-115-11-3-1	7311518003791	10	25
1-143-04-1-0	7311518105983	10	25
1-143-06-1-0	7311518019631	10	25
1-143-06-1-2	7311518022341	5	25
1-143-08-1-0	7311518019662	10	25
1-143-08-1-2	7311518028077	5	25
1-143-10-1-0	7311518019693	10	25
1-143-10-1-2	7311518022358	5	25
1-143-12-1-0	7311518019723	5	25
1-143-12-1-2	7311518295691	5	25
1-160-04-1-0	7311518019785	10	26
1-160-04-1-2	7311518244057	5	26

* Until stocks last



1-160-04-2-0	7311518019792	10	26
1-160-04-2-2	7311518244095	5	26
1-160-04-3-0	7311518019808	10	26
1-160-06-1-0	7311518019815	10	26
1-160-06-1-2	7311518000370	5	26
1-160-06-2-0	7311518019822	10	26
1-160-06-2-2	7311518003685	5	27
1-160-06-3-0	7311518019839	10	26
1-160-06-3-2	7311518295707	5	27
1-160-08-1-0	7311518019846	10	26
1-160-08-1-2	7311518000394	5	27
1-160-08-2-0	7311518019853	10	26
1-160-08-2-2	7311518003692	5	27
1-160-08-3-0	7311518019860	10	26
1-160-08-3-2	7311518295714	5	27
1-160-10-1-0	7311518019877	10	26
1-160-10-1-2	7311518000400	5	27
1-160-10-2-0	7311518019884	10	26
1-160-10-2-2	7311518295721	5	27
1-160-10-3-0	7311518019891	10	26
1-160-10-3-2	7311518295738	5	27
1-160-12-1-0	7311518019907	5	26
1-160-12-1-2	7311518295745	5	27
1-160-12-2-0	7311518019914	5	26
1-160-12-2-2	7311518295752	5	27
1-160-12-3-0	7314150292059	5	26
1-160-12-3-2	7311518298005	5	27
1-170-04-1-0	7311518044060	10	26
1-170-04-2-0	7311518019945	10	26
1-170-04-2-2	7311518244088	5	26
1-170-04-3-0	7311518019952	10	26
1-170-06-1-0	7311518019969	10	26
1-170-06-1-2	7311518244071	5	26
1-170-06-2-0	7311518019976	10	26
1-170-06-2-2	7311518003715	5	26
1-170-06-3-0	7311518019983	10	26
1-170-06-3-2	7311518295769	5	26
1-170-08-1-0	7311518019990	10	26
1-170-08-1-2	7311518000417	5	26
1-170-08-2-0	7311518020002	10	26
1-170-08-2-2	7311518003722	5	26
1-170-08-3-0	7311518020019	10	26
1-170-08-3-2	7311518295783	5	26
1-170-10-1-0	7311518020026	10	26
1-170-10-1-2	7311518028107	5	26
1-170-10-2-0	7311518020033	10	26
1-170-10-2-2	7311518244064	5	26
1-170-10-3-0	7311518020040	10	26
1-170-10-3-2	7311518295806	5	26
1-170-12-1-0	7311518020057	5	26
1-170-12-2-0	7311518020064	5	26
1-210-04-1-0	7311518020071	10	26
1-210-04-1-2	7311518243944	5	26
1-210-04-2-0	7311518020088	5	25
1-210-04-2-2	7311518244040	5	26
1-210-04-3-0	7311518020095	10	25
1-210-06-1-0	7311518020101	10	25
1-210-06-1-2	7311518000424	5	26
1-210-06-2-0	7311518020118	10	25
1-210-06-2-2	7311518003654	5	26
1-210-06-3-0	7311518020125	10	25
1-210-06-3-2	7311518293574	5	26
1-210-08-1-0	7311518020132	10	25
1-210-08-1-2	7311518000455	5	26
1-210-08-2-0	7311518020149	10	25
1-210-08-2-2	7311518000479	5	26
1-210-08-3-0	7311518020156	10	25
1-210-08-3-2	7311518295837	5	26
1-210-10-1-0	7311518020163	10	25
1-210-10-1-2	7311518000493	5	26
1-210-10-2-0	7311518020170	10	25
1-210-10-2-2	7311518003661	5	26
1-210-10-3-0	7311518020187	10	25
1-210-10-3-2	7311518295844	5	26
1-210-12-1-0	7311518020194	5	25
1-210-12-1-2	7311518028121	5	26
1-210-12-2-0	7311518020200	5	25
1-210-12-2-2	7311518244149	5	26
1-210-12-3-0	7311518020217	5	25
1-210-12-3-2	7311518295851	5	26
1-210-14-1-0	7311518020224	5	25
1-230-04-1-0	7311518020248	10	26
1-230-04-1-2	7311518244163	5	26
1-230-04-2-0	7311518020255	10	26
1-230-04-2-2	7311518244156	5	26
1-230-04-3-0	7311518020262	10	26
1-230-06-1-0	7311518020279	10	26
1-230-06-1-2	7311518000509	5	26
1-230-06-2-0	7311518020286	10	26
1-230-06-2-2	7311518000523	5	26
1-230-06-3-0	7311518020293	10	26
1-230-06-3-2	7311518293567	5	26
1-230-08-1-0	7311518020309	10	26
1-230-08-1-2	7311518000547	5	26
1-230-08-2-0	7311518020316	10	26
1-230-08-2-2	7311518000554	5	26





1-230-08-3-0	7311518020323	10	26
1-230-08-3-2	7311518295882	5	26
1-230-10-1-0	7311518020330	10	26
1-230-10-1-2	7311518000578	5	26
1-230-10-2-0	7311518020347	10	26
1-230-10-2-2	7311518003678	5	26
1-230-10-3-0	7311518020354	10	26
1-230-10-3-2	7311518295899	5	26
1-230-12-1-0	7311518020361	5	26
1-230-12-1-2	7311518295912	5	26
1-230-12-2-0	7311518020378	5	26
1-230-12-2-2	7311518295929	5	26
1-230-12-3-0	7311518020385	5	26
1-230-12-3-2	7311518295905	5	26
1-320-08-2-0	7311518191276	10	25
1-320-08-2-2	7311518270865	5	25
1-320-10-2-0	7311518020477	10	25
1-320-10-2-2	7311518270872	5	25
1-320-12-2-0	7311518020484	5	25
1-473-06-2-2	7311518201098	5	27
1-473-08-2-2	7311518201104	5	27
1-473-10-2-2	7311518201111	5	27
1-476-04-3-2	7311518010928	1	27
1-477-08-2-2	7311518037994	5	27
1-477-10-2-2	7311518201074	5	27
1-478-08-1-2	7311518141127	5	28
1-478-10-1-2	7311518241995	5	28
1-479-08-1-2	7311518176747	5	28
1-479-08-2-2	7311518180607	5	28
10-21-51	7311518229344	5	618
10-24-23	7311518229368	5	618
10-24-51	7311518229351	5	618
10-30-23	7311518229382	5	618
10-30-51	7311518229375	5	618
1016	7314150218189	10	224
1019	8412814010199	10	224
1031-10	7314150025442	5	559
1031-12	7314150025459	5	559
1031-14	7314150025466	5	559
1031-16	7314150025473	5	559
1031-18	7314150025480	5	559
1031-20	7314150025497	5	559
1031-22	7314150025503	5	559
1031-25	7314150025510	5	559
1031-28	7314150025527	5	559
1031-30	7314150025534	5	559
1031-32	7314150025541	5	559
1031-4	7314150025411	5	559
1031-40	7314150025558	5	559
1031-6	7314150025428	5	559
1031-8	7314150025435	5	559
1067	8412814010670	10	224
1084	7311518277291	5	274
10RM-10	7314153014351	60	47
10RM-13	7314153014368	60	47
10RM-14	7314150221677	60	47
10RM-17	7314153014375	30	47
10RM-19	7314153014382	30	47
10RM-8	7314153014344	60	47
10RM/SH6	7314150222971	1	48
10RZ-1/2	7314150358786	1	47
10RZ-11/16	7314150358816	1	47
10RZ-3/4	7314150358823	1	47
10RZ-3/8	7314150358762	1	47
10RZ-5/16	7314150358748	1	47
10RZ-5/8	7314150358809	1	47
10RZ-7/16	7314150358779	1	47
10RZ-9/16	7314150358793	1	47
111M-10	7314151828653	10	42
111M-100	7314150401499	1	42
111M-11	7314151828660	10	42
111M-12	7314151828677	10	42
111M-13	7314151828684	10	42
111M-14	7314151828691	10	42
111M-15	7314151828707	10	42
111M-16	7314151828714	10	42
111M-17	7314151828721	10	42
111M-18	7314151828738	10	42
111M-19	7314151828745	10	42
111M-20	7314151828752	10	42
111M-21	7314151828769	10	42
111M-22	7314151828776	5	42
111M-23	7314151828783	5	42
111M-24	7314151828790	5	42
111M-25	7314151828806	5	42
111M-26	7314151828813	5	42
111M-27	7314151828820	5	42
111M-28	7314151828837	5	42
111M-29	7314151828844	5	42
111M-30	7314151828851	5	42
111M-32	7314151828868	5	42
111M-33	7314150222223	5	42
111M-34	7314151828875	5	42
111M-36	7314150135516	1	42
111M-38	7314150222230	1	42
111M-41	7314150135523	1	42



111M-46	7314150135530	1	42
111M-5.5	7314151828608	10	42
111M-50	7314150135547	1	42
111M-55	7314150135554	1	42
111M-6	7314151828615	10	42
111M-60	7314150135561	1	42
111M-65	7314150135578	1	42
111M-7	7314151828622	10	42
111M-70	7314150135585	1	42
111M-75	7314150135592	1	42
111M-8	7314151828639	10	42
111M-80	7314150135608	1	42
111M-85	7314150352999	1	42
111M-9	7314151828646	10	42
111M-90	7314150401475	1	42
111M-95	7314150401482	1	42
111M/11T	7314151828899	1	44
111M/14T	7314151828905	1	44
111M/17T	7314151828912	1	44
111M/17TTL	7314150197859	1	44
111M/24T	7314150197866	1	44
111M/26T	7314151828929	1	44
111M/S10	7314150212965	1	44
111M/SH12	7314153013347	1	43
111M/SH5	7314150325252	1	43
111M/SH8	7314150197873	1	43
111Z-1	7314151829063	3	43
111Z-1.1/16	7314151829070	5	43
111Z-1.1/2	7314150135752	1	43
111Z-1.1/4	7314151829094	5	43
111Z-1.1/8	7314151829087	5	43
111Z-1.11/16	7314150135615	1	43
111Z-1.13/16	7314150135639	1	43
111Z-1.3/4	7314150135622	1	43
111Z-1.3/8	7314150135738	1	43
111Z-1.5/16	7314151829100	5	43
111Z-1.5/8	7314150135769	1	43
111Z-1.7/16	7314150135745	1	43
111Z-1.7/8	7314150135646	1	43
111Z-1/2	7314151828981	5	43
111Z-1/4	7314151828943	5	43
111Z-11/16	7314151829018	5	43
111Z-13/16	7314151829032	5	43
111Z-15/16	7314151829056	3	43
111Z-2	7314150135653	1	43
111Z-2.1/2	7314150135721	1	43
111Z-2.1/4	7314150135691	1	43
111Z-2.1/8	7314150135677	1	43
111Z-2.3/4	7314150135783	1	43
111Z-2.3/8	7314150135707	1	43
111Z-2.5/8	7314150135776	1	43
111Z-2.7/8	7314150135790	1	43
111Z-3	7314150135806	1	43
111Z-3/4	7314151829025	5	43
111Z-3/8	7314151828967	5	43
111Z-5/16	7314151828950	5	43
111Z-5/8	7314151829001	5	43
111Z-7/16	7314151828974	5	43
111Z-7/8	7314151829049	5	43
111Z-9/16	7314151828998	5	43
111Z/11T	7314151829124	1	45
111Z/8T	7314151829117	1	44
1150-1/2H/P	7314150129263	1	533
1150D	7311518276614	1	533
1154	7314150249831	1	321
1154-DG	7314150249800	1	321
1154-MB	7314150249817	1	321
1157	7311518277031	60	592
1162N-1/2	7314151847241	1	526
1177-SCRIBE	7314150120550	5	531
1178-SCRIBE	7314150120567	5	531
1179-FLX	7311518276997	25	531
1179-SCRIBE	7314150120574	5	531
1179-TIPS	7314150120581	1	531
11M-10	7314151829155	5	45
11M-11	7314151829162	5	45
11M-12	7314151829179	5	45
11M-13	7314151829186	5	45
11M-14	7314151829193	5	45
11M-15	7314151829209	5	45
11M-16	7314151829216	5	45
11M-17	7314151829223	5	45
11M-18	7314151829230	5	45
11M-19	7314151829247	5	45
11M-21	7314151829254	5	45
11M-22	7314151829261	5	45
11M-24	7314151829278	5	45
11M-27	7314151829285	1	45
11M-30	7314151829292	1	45
11M-32	7314151829308	1	45
11M-36	7314151829315	1	45
11M-38	7314151829322	1	45
11M-8	7314151829131	5	45
11M-9	7314151829148	5	45
11Z-1*	7314150355303	5	45
11Z-1/2*	7314150355235	5	45



11Z-11/16*	7314150355266	5	45
11Z-13/16*	7314150355280	5	45
11Z-3/4*	7314150355273	5	45
11Z-3/8*	7314150355211	5	45
11Z-5/8*	7314150355259	5	45
11Z-7/16*	7314150355228	5	45
11Z-9/16*	7314150355242	5	45
1300Z-1-1-1/8*	7314153000989	1	54
1300Z-1/2-9/16*	7314151039998	1	54
1300Z-1/4-5/16*	7314153000965	1	54
1300Z-15/16-1*	7314153005656	1	54
1300Z-19/32-11/16*	7314151040000	1	54
1300Z-25/32-13/16*	7314153000972	1	54
1300Z-3/8-7/16*	7314151039981	1	54
1300Z-5/8-3/4*	7314151040017	1	54
1300Z-7/8-15/16*	7314153005649	1	54
1320RM-10-11	7314153014511	60	49
1320RM-12-13	7314153014528	60	49
1320RM-14-15	7314153014535	30	49
1320RM-16-17	7314153014542	30	49
1320RM-17-19	7314150359196	30	49
1320RM-18-19	7314153014559	30	49
1320RM-22-24	7314150221646	30	49
1320RM-6-7	7314153014498	60	49
1320RM-8-9	7314153014504	60	49
1320RM/SH8	7314150229888	1	49
1320RZ-1/2-9/16	7314153014580	30	49
1320RZ-1/4-5/16	7314153014566	60	49
1320RZ-3/4-13/16	7314150359264	30	49
1320RZ-3/4-7/8	7314150359271	30	49
1320RZ-3/8-7/16	7314153014573	60	49
1320RZ-5/16-11/32	7314153015235	60	49
1320RZ-5/8-11/16	7314150359257	30	49
1320RZ-7/8-15/16	7314150359288	30	49
1320SRM-14-19	7314150190355	1	49
1320SRM/S29*	7314150188673	1	49
1321RZ-1/2-9/16	7314150359349	1	49
1321RZ-3/4-7/8	7314150359363	1	49
1321RZ-3/8-7/16	7314150359332	1	49
1321RZ-5/8-11/16	7314150359356	1	49
133SGM-100	7314151828523	1	57
133SGM-105	7314151828530	1	57
133SGM-110	7314151828547	1	57
133SGM-115	7314151828554	1	57
133SGM-120	7314151828561	1	57
133SGM-27	7314151828363	1	57
133SGM-30	7314151828370	1	57
133SGM-32	7314151828387	1	57
133SGM-36	7314151828394	1	57
133SGM-41	7314151828400	1	57
133SGM-46	7314151828417	1	57
133SGM-50	7314151828424	1	57
133SGM-55	7314151828431	1	57
133SGM-60	7314151828448	1	57
133SGM-65	7314151828455	1	57
133SGM-70	7314151828462	1	57
133SGM-75	7314151828479	1	57
133SGM-80	7314151828486	1	57
133SGM-85	7314151828493	1	57
133SGM-90	7314151828509	1	57
133SGM-95	7314151828516	1	57
14-24-3810	7311518002879	5	619
140	7314150008797	1	270
141	7314150008827	1	270
1410	7314150106332	1	270
1410D	7314150452842	1	270
1418-4	7314150510863	1	364
1418-5	7314150510870	1	364
1418-6	7314150510887	1	364
1418-7.5	7314150510894	1	364
1418-8.5	7314150510900	1	364
1418S	7314151040604	1	363
1419-M12	7314150257423	1	363
1419-M16	7314150358045	1	363
1419-M5	7314150257409	1	363
1419-M8	7314150257416	1	363
1419-MD	7311518277352	1	337
1419/4	7314150125036	1	363
142	7314150008841	1	270
1420	7314150103744	1	270
1420-1.4	7314151696337	1	363
1420D	7314150452859	1	270
1421-2.1	7314151696412	1	363
1422-3.1	7314151696689	1	363
1423-4.8	7314151696764	1	363
1424-6.2	7314151696849	1	363
143	7314150008872	1	270
1430FT120	7314150342006	1	377
1435/5	7314151040734	1	363
1435/8	7314151040741	1	363
144	7314150008902	1	270
1446	7314150128631	15	571
1446-CS	7314150508266	15	571
1446-FLOAT	7314150438464	15	571
1446-FLOAT-B	7314150524310	12	571
1446-OV	7314150313679	15	571

* Until stocks last



1450D-ISO	7314151040970	1	366
1450D-VVV	7314151040987	1	366
1450D/2	7314151040963	1	366
1460M/1	7314151041090	1	365
1460M/2	7314151041106	1	365
1460Z/2	7314151041120	1	365
1467-250	7314150124268	1	266
1467-320-850	7314150178636	1	267
1467-520	7314150124275	1	267
1467-LJ	7314150209033	1	267
1467-SJ	7314150208982	1	267
1468-10M10	7314150243457	1	343
1468-10M4	7314150243419	1	343
1468-10M5	7314150243426	1	343
1468-10M6	7314150243433	1	343
1468-10M8	7314150243440	1	343
1468-6M3	7314150243372	1	343
1468-6M4	7314150243389	1	343
1468-6M5	7314150243396	1	343
1468-6M6	7314150243402	1	343
1468-M10	7314150243228	6	343
1468-M6	7314150243211	1	343
147	7314150008933	1	270
147-1	7314150367047	1	123
147-1.1/4	7314150367061	1	123
147-1.1/8	7314150367054	1	123
147-1/2	7314150366965	1	123
147-11/16	7314150366996	1	123
147-13	7314150366644	1	123
147-13/16	7314150367016	1	123
147-14	7314150366651	1	123
147-15	7314150366668	1	123
147-15/16	7314150367030	1	123
147-16	7314150366675	1	123
147-17	7314150366682	1	123
147-18	7314150366699	1	123
147-19	7314150366705	1	123
147-21	7314150366712	1	123
147-22	7314150366729	1	123
147-24	7314150366736	1	123
147-25	7314150366743	1	123
147-27	7314150366750	1	123
147-3/4	7314150367009	1	123
147-30	7314150366767	1	123
147-32	7314150366774	1	123
147-33	7314150366781	1	123
147-34	7314150366798	1	123
147-35	7314150366804	1	123
147-36	7314150366811	1	123
147-37	7314150366828	1	123
147-38	7314150366835	1	123
147-39	7314150366842	1	123
147-41	7314150366859	1	123
147-45	7314150366866	1	123
147-46	7314150366873	1	123
147-5/8	7314150366989	1	123
147-50	7314150366880	1	123
147-55	7314150366897	1	123
147-60	7314150366903	1	123
147-65	7314150366910	1	123
147-68	7314150366910	1	123
147-7/16	7314150366958	1	123
147-7/8	7314150367023	1	123
147-70	7314150366927	1	123
147-75	7314150366934	1	123
147-9/16	7314150366972	1	123
147-90	7314150366941	1	123
1470K-AC1	7314150226498	1	376
1470K-AC2	7314150226504	1	376
1470K-AC3	7314150226511	1	376
1470K-AC4	7314150226528	1	376
1470K-AC7	7314150271320	1	377
1470K-ACSIDE	7314150226535	1	376
1470K-ACTD	7314150297269	1	376
1470K-ACTSS	7314150297283	1	376
1470K-ACTW	7314150297276	1	376
1470K7LH	7314150360444	1	375
1470K7SS	7314150343287	1	514
1470KAC01	7314150165124	1	424
1470K2C	7314150226696	1	377
1470K3A	7314150506354	1	377
1470KCTRAY	7314150226702	1	377
1470KXL-ACTD	7314150297290	1	376
1470KXL-ACTSS	7314150297313	1	376
1470KXL-ACTW	7314150297306	1	376
1470KXLC-TRAY	7314150285549	1	377
1471KXXL12BKTSS	7314150365432	1	374
1472K-ACTD	7314150399345	1	374
1472K-ACTSS	7314150399338	1	374
1472K-ACTW	7314150393152	1	374
1472K5	7314150349463	1	371
1472K5BLACK	7314150349500	1	371
1472K5BLUE	7314150349616	1	371
1472K5GREY	7314150403813	1	371
1472K5RED	7314150349562	1	371
1472K5WHITE	7314150403707	1	371



1472K6



1472K6	7314150349470	1	371
1472K6BLACK	7314150349531	1	371
1472K6BLUE	7314150349623	1	371
1472K6GREY	7314150403820	1	371
1472K6RED	7314150349579	1	371
1472K6WHITE	7314150399888	1	371
1472K7	7314150349487	1	371
1472K7BLACK	7314150349548	1	371
1472K7BLUE	7314150349630	1	371
1472K7GREY	7314150403837	1	371
1472K7RED	7314150349586	1	371
1472K7WHITE	7314150403714	1	371
1472K8	7314150349494	1	370
1472K8BLACK	7314150349555	1	370
1472K8BLUE	7314150349647	1	370
1472K8GREY	7314150404018	1	370
1472K8RED	7314150349593	1	370
1472K8WHITE	7314150403721	1	370
1475K-ACSIDE	7314150419968	1	377
1475K6	7314150349654	1	375
1475K6BLACK	7314150349685	1	375
1475K6BLUE	7314150349760	1	375
1475K6RED	7314150349715	1	375
1475K7	7314150349661	1	375
1475K7BLACK	7314150349692	1	375
1475K7BLUE	7314150349814	1	375
1475K7RED	7314150349746	1	375
1475K8	7314150349678	1	375
1475K8BLACK	7314150349708	1	375
1475K8BLUE	7314150349821	1	375
1475K8RED	7314150349753	1	375
1475KXL-AC20BK	7314150353903	1	376
1475KXL12	7314150350223	1	374
1475KXL12BLACK	7314150350230	1	374
1475KXL12RED	7314150402731	1	374
1475KXL6	7314150349968	1	375
1475KXL6BLACK	7314150349999	1	375
1475KXL6BLUE	7314150350162	1	375
1475KXL6C	7314150350193	1	375
1475KXL6CBK-FF5	7314150437467	1	370
1475KXL6CBK-FF6	7314150437474	1	369
1475KXL6CBBLACK	7314150350209	1	375
1475KXL6RED	7314150350124	1	375
1475KXL7	7314150349975	1	374
1475KXL7BLACK	7314150350070	1	374
1475KXL7BLUE	7314150350179	1	374
1475KXL7RED	7314150350148	1	374
1475KXL7SS	7314150349517	1	514
1475KXL8	7314150349982	1	374
1475KXL8BLACK	7314150350094	1	374
1475KXL8BLUE	7314150350186	1	374
1475KXL8RED	7314150350155	1	374
1475KXL-ACTSS	7314150459896	1	375
1475KXL-ACTW	7314150465330	1	375
1475KXL8CWTSS	7314150400157	1	374
1476KXL7BK	7314150439935	1	374
1477K-AC10	7314150353163	1	373
1477K-AC11	7314150369874	1	424
1477K-AC12	7314150369195	1	371
1477K-AC13	7314150369218	1	371
1477K-AC14	7314150369225	1	372
1477K-AC15	7314150369249	1	372
1477K-AC16	7314150369256	1	372
1477K-AC17	7314150369270	1	372
1477K-AC18	7314150369287	1	372
1477K-AC19	7314150369676	1	372
1477K-AC20	7314150369683	1	372
1477K-AC21	7314150370412	1	372
1477K-AC22	7314150369706	1	372
1477K-AC23	7314150369867	1	424
1477K-AC24	7314150370429	1	373
1477K-AC25	7314150370436	1	373
1477K-AC26	7314150414864	1	373
1477K-AC28	7314150370481	1	424
1477K-AC29	7314150370498	1	424
1477K-AC30	7314150469949	1	373
1477K-AC3D	7314150370474	1	373
1477K-ACTP	7314150383764	1	373
1477K-ACTSS	7314150370450	1	373
1477K-ACTW	7314150370467	1	373
1477K6	7314150350391	1	370
1477K6BLACK	7314150351091	1	370
1477K6GREY	7314150351138	1	370
1477K6RED	7314150403653	1	370
1477K6WHITE	7314150358137	1	370
1477K7	7314150350407	1	370
1477K7BLACK	7314150351107	1	370
1477K7GREY	7314150351145	1	370
1477K7RED	7314150403660	1	370
1477K7WHITE	7314150358144	1	370
1477K8	7314150350414	1	370
1477K8BLACK	7314150351114	1	370
1477K8GREY	7314150351183	1	370
1477K8RED	7314150403677	1	370
1477K8WHITE	7314150358151	1	370
1477K9	7314150350940	1	370



1477K9BLACK	7314150351121	1	370
1477K9GREY	7314150351190	1	370
1477K9RED	7314150403684	1	370
1477K9WHITE	7314150403691	1	370
148-1	7314150367801	1	124
148-1/2	7314150367726	1	124
148-11/16	7314150367757	1	124
148-13	7314150367559	1	124
148-13/16	7314150367771	1	124
148-14	7314150367566	1	124
148-15	7314150367573	1	124
148-15/16	7314150367795	1	124
148-16	7314150367580	1	124
148-17	7314150367597	1	124
148-18	7314150367603	1	124
148-19	7314150367610	1	124
148-21	7314150367627	1	124
148-22	7314150367634	1	124
148-24	7314150367641	1	124
148-27	7314150367658	1	124
148-28	7314150367665	1	124
148-3/4	7314150367764	1	124
148-30	7314150367672	1	124
148-32	7314150367689	1	124
148-34	7314150367696	1	124
148-36	7314150367702	1	124
148-41	7314150367719	1	124
148-5/8	7314150367740	1	124
148-7/8	7314150367788	1	124
148-9/16	7314150367733	1	124
1482K4	7314150415779	1	371
1482K4BKW	7314150426126	1	371
1482K4BLACK	7314150415786	1	371
1482K4BLUE	7314150415793	1	371
1482K4GREY	7314150415809	1	371
1482K4RED	7314150415816	1	371
1482K4W	7314150425174	1	371
1482K4WHITE	7314150415823	1	371
1482K5W	7314150431274	1	371
1483CART	7314150273256	1	443
1483K2RB	7314150230013	1	443
1483K3RB	7314150230037	1	443
1483KHD3RB	7314150230099	1	443
1483KHD3RB-FF1	7314150233564	1	441
1483KHD3RB-FF2	7314150233571	1	442
1483KHD3RB-FF3	7314150233588	1	442
1483KHD3RB-FF4	7314150233595	1	442
1483KHD3RB-FF5	7314150233601	1	442
1483KHD3RB-FF7*	7314150336050	1	442
1483KHD4RB	7314150230105	1	443
1484THD3RB	7314150265435	1	443
1485K4	7314150349838	1	375
1485K4BLACK	7314150349920	1	375
1485K4BLUE	7314150349944	1	375
1485K4RED	7314150349937	1	375
1485KXL4	7314150350247	1	375
1485KXL4BLACK	7314150350346	1	375
1485KXL4BLUE	7314150350360	1	375
1485KXL4RED	7314150350353	1	375
1487K4	7314150351206	1	370
1487K4BKW	7314150426133	1	370
1487K4BLACK	7314150351213	1	370
1487K4GREY	7314150351237	1	370
1487K4W	7314150425181	1	370
1495CD-AC1	7314150296965	1	438
1495CD60	7314150296927	1	436
1495CD60TS1	7314150325627	1	435
1495CD60W	7314150303656	1	436
1495CS-AC1	7314150296910	1	439
1495CS15	7314150296934	1	436
1495CS15BL	7314150326860	1	436
1495CS15TS1	7314150325610	1	435
1495CS18	7314150296941	1	436
1495CS18BL	7314150326891	1	436
1495CS18BLHK	7314150407620	1	436
1495CS18HK	7314150407613	1	436
1495CS18TS1	7314150325603	1	435
1495FWB120TS	7314150296668	1	441
1495K6CWB15TS	7314150368440	1	440
1495K6CWB15TW	7314150368501	1	440
1495K6CWB18TS	7314150369355	1	440
1495K6CWB18TW	7314150369393	1	440
1495K7CWB15TS	7314150368464	1	440
1495K7CWB15TW	7314150368518	1	440
1495K7CWB18TS	7314150369362	1	440
1495K7CWB18TW	7314150369409	1	440
1495K8CWB15TS	7314150368471	1	440
1495K8CWB15TW	7314150368525	1	440
1495K8CWB18TS	7314150370061	1	440
1495K8CWB18TW	7314150369416	1	440
1495KWB15TS	7314150338115	1	440
1495KWB15TW	7314150296613	1	441
1495KWB18TS	7314150338122	1	440
1495KWB18TW	7314150296620	1	441
1495TP-AC1	7314150297030	1	438
1495TP-AC10	7314150297207	1	439



1495TP-AC11	7314150297214	1	439
1495TP-AC12	7314150297221	1	439
1495TP-AC13	7314150297238	1	439
1495TP-AC2	7314150297122	1	439
1495TP-AC3	7314150297139	1	439
1495TP-AC4	7314150297146	1	439
1495TP-AC5	7314150297153	1	439
1495TP-AC6	7314150297160	1	439
1495TP-AC7	7314150297177	1	440
1495TP-AC8	7314150297184	1	440
1495TP-AC9	7314150297191	1	440
1495TP-ACHL20	7314150297047	1	440
1495TP-ACHL40	7314150297054	1	440
1495TP-ACHL65	7314150297061	1	440
1495TP-ACHL90	7314150297078	1	440
1495TP-ACHU20	7314150297085	1	440
1495TP-ACHU40	7314150297092	1	440
1495TP-ACHU65	7314150297108	1	440
1495TP-ACHU90	7314150297115	1	440
1495TP-AUTO-M1	7314150438266	1	436
1495TP-AUTO-M2	7314150438273	1	437
1495TP-AUTO-M3	7314150438280	1	437
1495TP-AUTO-M4	7314150438297	1	437
1495TP-AUTO-M5	7314150438303	1	438
1495TP-AUTO-M6	7314150438310	1	438
1495TP06	7314150296989	1	438
1495TP09	7314150438624	1	438
1495TP09-RAIL	7314150465705	1	438
1495TP12	7314150296996	1	438
1495TP15	7314150297009	1	438
1495TP18	7314150297016	1	438
1495WB-AC1	7314150296576	1	441
1495WB15-AC1	7314150296590	1	441
1495WB15TS	7314150296514	1	441
1495WB15TSBL	7314150326990	1	441
1495WB15TSBT	7314150407651	1	441
1495WB15TW	7314150296538	1	441
1495WB18-AC1	7314150296606	1	441
1495WB18TS	7314150296545	1	441
1495WB18TSBL	7314150327027	1	441
1495WB18TSBT	7314150407637	1	441
1495WB18TW	7314150296569	1	441
1496MB2	7314150273478	1	448
1496MB3	7314150273485	1	448
1496MB4	7314150273492	1	448
1496MB5	7314150273508	1	448
1497MB08	7314150349869	1	448
1497MB13	7314150349876	1	448
1497MB18	7314150349913	1	449
1497MBF350	7314150321391	1	448
1497MBF550	7314150321407	1	448
1497MBF750	7314150321414	1	447
1497MBW	7314150330164	1	447
14A-32	7314150368228	1	125
14A-9	7314150368211	1	125
14F-1/2	7314150366200	1	122
14F-3/4	7314150366217	1	122
14P-1/2	7314150366064	1	122
14Q-1/2	7314150366026	1	122
14R-1/2	7314150365920	1	121
14R-3/4	7314150365937	1	121
14T-1/2	7314150366125	1	122
14T-3/4	7314150366132	1	122
14W	7314150357031	1	125
1519 D	7314150032747	3	240
1519-9	7314150026074	1	240
1520 D	7311518278922	5	237
1520 G	7311518266516	5	237
1520 G IP	7314150437740	5	237
1535	7314150214808	1	533
1537	7314150214822	1	533
1544	7311518276560	1	533
1546	7314150214792	1	533
1547	7311518276577	20	533
158-N	7311518277239	12	246
158-NB	7311518277246	12	247
1610	7314150404186	1	270
1610-NUT	7314150409594	1	270
1620	7314150404193	1	270
1620-NUT	7314150409754	1	270
166-6-16-2.5-12	7311518021979	12	28
166-6-16-2.5-2	7311518209698	5	28
167-1	7314150419067	1	126
167-1.1/16	7314150419074	1	126
167-1.1/4	7314150419104	1	126
167-1.1/8	7314150419081	1	126
167-1.3/16	7314150419098	1	126
167-1/2	7314150418930	1	126
167-10	7314150418657	1	126
167-11	7314150418664	1	126
167-11/16	7314150419364	1	126
167-12	7314150418671	1	126
167-13	7314150418688	1	126
167-13/16	7314150419036	1	126
167-14	7314150418695	1	126
167-15	7314150418701	1	126

* Until stocks last



167-15/16	7314150419050	1	126
167-16	7314150418718	1	126
167-17	7314150418725	1	126
167-18	7314150418732	1	126
167-19	7314150418749	1	126
167-20	7314150418763	1	126
167-21	7314150418770	1	126
167-22	7314150418787	1	126
167-23	7314150418794	1	126
167-24	7314150418800	1	126
167-25	7314150418817	1	126
167-26	7314150418824	1	126
167-27	7314150418831	1	126
167-28	7314150418848	1	126
167-3/4	7314150419029	1	126
167-3/8	7314150418909	1	126
167-30	7314150418855	1	126
167-32	7314150418862	1	126
167-36	7314150418886	1	126
167-5/16	7314150418893	1	126
167-5/8	7314150419012	1	126
167-7	7314150418619	1	126
167-7/16	7314150418916	1	126
167-7/8	7314150419043	1	126
167-8	7314150418626	1	126
167-8-21-3.2-12	7311518021986	12	28
167-9	7314150418640	1	126
167-9/16	7314150419005	1	126
168-1	7314150419562	1	127
168-1.1/16	7314150419579	1	127
168-1.3/16	7314150419586	1	127
168-1/2	7314150419487	1	127
168-10	7314150419272	1	126
168-11	7314150419289	1	126
168-11/16	7314150419517	1	127
168-12	7314150419296	1	127
168-13	7314150419302	1	127
168-13/16	7314150419531	1	127
168-14	7314150419319	1	127
168-15	7314150419326	1	127
168-15/16	7314150419555	1	127
168-16	7314150419333	1	127
168-17	7314150419340	1	127
168-18	7314150419357	1	127
168-19	7314150419371	1	127
168-20	7314150419388	1	127
168-21	7314150419395	1	127
168-22	7314150419401	1	127
168-23	7314150419418	1	127
168-24	7314150419425	1	127
168-26	7314150419432	1	127
168-27	7314150419449	1	127
168-3/4	7314150419524	1	127
168-3/8	7314150419463	1	127
168-5/16	7314150419456	1	127
168-5/8	7314150419500	1	127
168-6-3.2-1P	7311518152338	12	28
168-6-3.2-3P	7311518152413	12	28
168-6-3.5-1P	7311518152345	12	28
168-6-3.5-3P	7311518152420	12	28
168-7	7314150419241	1	126
168-7/16	7314150419470	1	127
168-7/8	7314150419548	1	127
168-8	7314150419258	1	126
168-8-4.0-1P	7311518152352	12	28
168-8-4.0-3P	7311518152437	12	28
168-8-4.0-6	7311518217419	6	29
168-8-4.5-1P	7311518152369	12	28
168-8-4.5-3P	7311518152444	12	28
168-8-4.5-6	7311518217426	6	29
168-8-4.8-1P	7311518152376	12	28
168-8-4.8-3P	7311518152451	12	28
168-8-4.8-6	7311518217433	6	29
168-8-5.2-1P	7311518152383	12	28
168-8-5.2-3P	7311518152468	12	28
168-8-5.2-6	7311518217440	6	29
168-8-5.5-1P	7311518152390	12	28
168-8-5.5-3P	7311518152475	12	28
168-8-5.5-6	7311518217457	6	29
168-8-6.3-1P	7311518152406	12	28
168-8-6.3-3P	7311518152482	12	28
168-9	7314150419265	1	126
168-9/16	7314150419494	1	127
168-COMBI-4.0	7311518209667	10	29
168-COMBI-4.0-6922	7311518209612	10	29
168-COMBI-4.5	7314150272860	10	29
168-COMBI-4.8	7311518209674	10	29
168-COMBI-4.8-6920	7311518209643	10	29
168-COMBI-5.5	7311518209681	10	29
168-COMBI-5.5-6924	7311518209650	10	29
169-10	7314150419630	1	127
169-11	7314150419647	1	127
169-12	7314150419654	1	127
169-13	7314150419661	1	127
169-14	7314150419678	1	127
169-15	7314150419715	1	127





169-16	7314150419722	1	127
169-17	7314150419739	1	127
169-18	7314150419746	1	127
169-19	7314150419753	1	127
169-20	7314150419760	1	127
169-21	7314150419777	1	127
169-22	7314150419784	1	127
169-23	7314150419791	1	127
169-24	7314150419807	1	127
169-27	7314150419814	1	127
169-7	7314150419609	1	127
169-8	7314150419616	1	127
169-9	7314150419623	1	127
16F-1/2	7314150418565	1	125
16F-1/4	7314150418541	1	125
16F-3/8	7314150418558	1	125
16R-1/2	7314150418602	1	125
16R-1/4	7314150418589	1	125
16R-3/8	7314150418596	1	125
1931M-10	7314151049256	5	51
1931M-11	7314151049263	5	51
1931M-12	7314151049270	5	51
1931M-13	7314151049287	5	51
1931M-14	7314151049294	5	51
1931M-17	7314151049324	5	51
1931M-4	7314151049171	5	51
1931M-4.5	7314151049188	5	51
1931M-5	7314151049195	5	51
1931M-5.5	7314151049201	5	51
1931M-6	7314151049218	5	51
1931M-7	7314151049225	5	51
1931M-8	7314151049232	5	51
1931M-9	7314151049249	5	51
1931M/10T	7314151049409	1	52
1931Z-1/2	7314151049775	5	51
1931Z-1/4	7314151049713	5	51
1931Z-1/8	7314150371563	5	51
1931Z-11/32	7314151049744	5	51
1931Z-11/32-3/8	7314150371624	5	51
1931Z-13/64	7314151049683	5	51
1931Z-15/64-1/4	7314150371570	5	51
1931Z-3/16	7314151049676	5	51
1931Z-3/8	7314151049751	5	51
1931Z-5/16	7314151049737	5	51
1931Z-5/32	7314151049669	5	51
1931Z-5/8	7314151049799	5	51
1931Z-7/16	7314151049768	5	51
1931Z-7/32	7314151049690	5	51
1931Z-9/16	7314151049782	5	51
1931Z-9/32	7314151049720	5	51
1931Z-9/32-5/16	7314150371600	5	51
1931Z/12T	7314150107674	1	52
1933M/6T	7314151821654	1	52
1936M-10-11	7314151051402	25	60
1936M-10-13	7314151344146	25	60
1936M-12-13	7314151051419	25	60
1936M-13-17	7314151830144	20	60
1936M-14-15	7314151051426	20	60
1936M-14-17	7314151051129	15	60
1936M-16-17	7314151051433	15	60
1936M-17-19	7314151051136	10	60
1936M-18-19	7314151051440	10	60
1936M-19-22	7314151051150	8	60
1936M-20-22	7314151830151	8	60
1936M-21-23	7314151830168	8	60
1936M-22-24	7314151830175	5	60
1936M-24-26	7314151830182	5	60
1936M-24-27	7314151051181	5	60
1936M-25-28	7314151830199	5	60
1936M-30-32	7314151051501	1	60
1936M-30-34	7314151838577	4	60
1936M-36-41	7314151830205	4	60
1936M-46-50	7314151830212	2	60
1936M-6-7	7314151051389	50	60
1936M-8-10	7314151830137	30	60
1936M-8-9	7314151051396	5	60
1936M/12	7314151830250	1	60
1936M/7	7314151830243	1	60
1943M-11-13*	7314151052829	1	55
1943M-13-15*	7314151804732	1	55
1943M-13-17*	7314151804749	1	55
1943M-14-17*	7314151052843	1	55
1943M-15-17*	7314151052850	1	55
1943M-19-22*	7314151052867	1	55
1943Z-11/16-13/16*	7314150355174	1	55
1943Z-5/16-3/8*	7314150355136	1	55
1943Z-5/8-3/4*	7314150355167	1	55
1943Z-7/16-1/2*	7314150355143	1	55
1943Z-9/16-5/8*	7314150355150	1	55
1945W12	7314150352289	6	312
1945W14	7314150352265	8	312
1945W38	7314150352272	6	312
1949M-10-11	7314151055394	1	56
1949M-10-12	7314151055400	1	56
1949M-12-13	7314151055417	1	56
1949M-12-14	7314151055424	1	56



1949M-14-15	7314151304546	1	56
1949M-14-17	7314151055448	1	56
1949M-17-19	7314151055455	1	56
1949M-19-22	7314151055462	1	56
1949M-22-24	7314151304553	1	56
1949M-24-27	7314151055479	1	56
1949M-30-32	7314151304577	1	56
1949M-8-9	7314151304539	1	56
1949Z-1-1.1/8	7314151055547	1	56
1949Z-1/2-9/16	7314151055509	1	56
1949Z-3/4-7/8	7314151055530	1	56
1949Z-3/8-7/16	7314151055486	1	56
1949Z-5/8-3/4	7314151055523	1	56
1950MZ-3/8	7314150130207	1	57
1952M-10	7314151057213	10	45
1952M-11	7314151057220	10	45
1952M-12	7314151057237	10	45
1952M-13	7314151057244	10	45
1952M-14	7314151057251	10	45
1952M-15	7314151057268	10	45
1952M-16	7314151057275	10	45
1952M-17	7314151057282	10	45
1952M-18	7314151057299	10	45
1952M-19	7314151057305	10	45
1952M-20	7314151057312	10	45
1952M-21	7314151057329	10	45
1952M-22	7314151057336	5	45
1952M-23	7314151057343	5	45
1952M-24	7314151057350	5	45
1952M-25	7314151057367	5	45
1952M-26	7314151057374	5	45
1952M-27	7314151057381	5	45
1952M-28	7314151057398	1	45
1952M-29	7314151325763	1	45
1952M-30	7314151057404	1	45
1952M-32	7314151057411	1	45
1952M-34	7314151838553	1	45
1952M-36	7314151057428	1	45
1952M-41	7314151057435	1	45
1952M-46	7314151840105	1	45
1952M-50	7314151840112	1	45
1952M-55	7314151840129	1	45
1952M-6	7314151057176	10	45
1952M-60	7314151840136	1	45
1952M-65	7314150135226	1	45
1952M-7	7314151057183	10	45
1952M-70	7314150135301	1	45
1952M-75	7314150135325	1	45
1952M-8	7314151057190	10	45
1952M-80	7314150135509	1	45
1952M-9	7314151057206	10	45
1952M/10	7314151057688	1	46
1952M/14T	7314151057695	1	46
1952M/17T	7314151057473	1	46
1952M/26T	7314151057701	1	46
1952M/7T	7314151806637	1	46
1952M/SH12	7314153013330	1	46
1952M/SH6	7314153013286	1	46
1952Z-1	7314151057602	1	45
1952Z-1.1/16	7314151057619	1	45
1952Z-1.1/2	7314151057756	1	45
1952Z-1.1/4	7314151057633	1	45
1952Z-1.1/8	7314151057626	1	45
1952Z-1.3/8	7314151057732	1	45
1952Z-1.5/16	7314151057718	1	45
1952Z-1.5/8	7314151057763	1	45
1952Z-1.7/16	7314151057749	1	45
1952Z-1/2	7314151057527	5	45
1952Z-1/4	7314151057480	5	45
1952Z-11/16	7314151057558	5	45
1952Z-11/32	7314150111046	5	45
1952Z-13/16	7314151057572	5	45
1952Z-15/16	7314151057596	5	45
1952Z-3/4	7314151057565	5	45
1952Z-3/8	7314151057503	5	45
1952Z-5/16	7314151057497	5	45
1952Z-5/8	7314151057541	5	45
1952Z-7/16	7314151057510	5	45
1952Z-7/8	7314151057589	5	45
1952Z-9/16	7314151057534	5	45
1952Z/11T	7314151057725	1	47
1976TORX-T10	7314150123438	5	234
1976TORX-T15	7314150123452	5	234
1976TORX-T20	7314150123469	5	234
1976TORX-T25	7314150123476	5	234
1976TORX-T27	7314150123490	5	234
1976TORX-T30	7314150123506	5	234
1976TORX-T40	7314150123513	5	234
1976TORX-T6	7314150122240	5	234
1976TORX-T7	7314150123384	5	234
1976TORX-T8	7314150123391	5	234
1976TORX-T9	7314150123414	5	234
1976TORX/5T	7314150126927	1	234
1986TORX-T10	7314150123537	5	233
1986TORX-T15	7314150123544	5	233
1986TORX-T20	7314150123551	5	233



1986TORX-T25	7314150123568	5	233
1986TORX-T27	7314150123575	5	233
1986TORX-T30	7314150123582	5	233
1986TORX-T40	7314150123599	5	233
1986TORX-T9	7314150122233	5	233
1986TORX/7T	7314150123735	1	233
1995LM-1.5	7314150123172	10	230
1995LM-10	7314150123254	10	230
1995LM-12	7314150123261	10	230
1995LM-14	7314150123278	10	230
1995LM-2	7314150122189	10	230
1995LM-2.5	7314150123162	10	230
1995LM-3	7314150123179	10	230
1995LM-4	7314150123186	10	230
1995LM-5	7314150123209	10	230
1995LM-6	7314150123216	10	230
1995LM-7	7314150123223	10	230
1995LM-8	7314150123230	10	230
1995LM-9	7314150123247	10	230
1995M-0.9	7314150126291	10	229
1995M-1.5	7314150122158	10	229
1995M-10	7314150122912	10	229
1995M-12	7314150122943	10	229
1995M-14	7314150122967	10	229
1995M-17	7314150122974	10	229
1995M-19	7314150122981	10	229
1995M-2	7314150122745	10	229
1995M-2.5	7314150122752	10	229
1995M-22	7314150122998	10	229
1995M-3	7314150122769	10	229
1995M-4	7314150122776	10	229
1995M-5	7314150122790	10	229
1995M-6	7314150122813	10	229
1995M-7	7314150122837	10	229
1995M-8	7314150122851	10	229
1995M-9	7314150122875	10	229
1995M/10T	7314150123643	1	229
1995M/11T	7314150123650	1	229
1995M/15T	7314150123667	1	229
1995M/6T	7314150123629	1	229
1995M/8T	7314150123636	1	229
1995TORX-T10	7314150123308	5	232
1995TORX-T15	7314150123322	5	232
1995TORX-T20	7314150123339	5	232
1995TORX-T25	7314150123346	5	232
1995TORX-T27	7314150123353	5	232
1995TORX-T30	7314150123360	5	232
1995TORX-T40	7314150123377	5	232
1995TORX-T45	7314150123407	5	232
1995TORX-T50	7314150123421	5	232
1995TORX-T55	7314150216963	5	232
1995TORX-T6	7314150122196	5	232
1995TORX-T60	7314150216970	5	232
1995TORX-T7	7314150123285	5	232
1995TORX-T8	7314150123292	5	232
1995TORX-T9	7314150122219	5	232
1995TORX/11T	7314150123742	1	232
1995TORX/13T	7314150123759	1	232
1995TORX/4T	7314150123674	1	232
1995TORX/7T	7314150123711	1	232
1995Z-1/16	7314150122165	10	229
1995Z-1/2	7314150123117	10	229
1995Z-1/4	7314150123070	10	229
1995Z-1/8	7314150123025	10	229
1995Z-3/16	7314150123056	10	229
1995Z-3/32	7314150123018	10	229
1995Z-3/4	7314150123155	10	229
1995Z-3/8	7314150123094	10	229
1995Z-5/16	7314150123087	10	229
1995Z-5/32	7314150123049	10	229
1995Z-5/64	7314150123001	10	229
1995Z-5/8	7314150123131	10	229
1995Z-7/16	7314150123100	10	229
1995Z-7/32	7314150123063	10	229
1995Z/10T	7314150215980	1	230
1995Z/12T	7314150215997	1	230
1996M-1.5	7314150122202	10	231
1996M-10	7314150122721	10	231
1996M-12	7314150122738	5	231
1996M-2	7314150122653	10	231
1996M-2.5	7314150122660	10	231
1996M-3	7314150122677	10	231
1996M-4	7314150122684	10	231
1996M-5	7314150122691	10	231
1996M-6	7314150122707	10	231
1996M-8	7314150122714	10	231
1996TORX-T10	7314150122783	5	233
1996TORX-T15	7314150122806	5	233
1996TORX-T20	7314150122820	5	233
1996TORX-T25	7314150122844	5	233
1996TORX-T27	7314150122868	5	233
1996TORX-T30	7314150122882	5	233
1996TORX-T40	7314150122899	5	233
1996TORX-T45	7314150122905	5	233
1996TORX-T50	7314150122929	5	233
1996TORX-T9	7314150122226	5	233

* Until stocks last



1996TORX/5T	7314150123698	1	233
1998M-1.5	7314150185719	10	228
1998M-10	7314150185801	10	228
1998M-12	7314150185818	5	228
1998M-14	7314150185825	1	228
1998M-17	7314150185832	1	228
1998M-19	7314150185849	1	228
1998M-2	7314150185726	10	228
1998M-2.5	7314150185733	10	228
1998M-22	7314150185856	1	228
1998M-3	7314150185740	10	228
1998M-4	7314150185757	10	228
1998M-5	7314150185764	10	228
1998M-6	7314150185863	10	228
1998M-7	7314150185771	10	228
1998M-8	7314150185788	10	228
1998M-9	7314150185795	5	228
1998M/10T	7314150186228	1	228
1998M/11T	7314150186235	1	228
1998M/15T	7314150186242	1	228
1998M/6T	7314150186204	1	228
1998M/8T	7314150186211	1	228
1999M/7H*	7314151801076	1	228
1999MV-10	7314150121496	3	490
1999MV-12	7314150121502	3	490
1999MV-3	7314150121427	5	490
1999MV-4	7314150121434	5	490
1999MV-5	7314150121441	5	490
1999MV-6	7314150121458	5	490
1999MV-7	7314150121465	5	490
1999MV-8	7314150121472	5	490
1999MV-9	7314150121489	5	490
1RM-10	7314153000576	60	47
1RM-11	7314153000583	60	47
1RM-12	7314153000590	60	47
1RM-13	7314153000606	60	47
1RM-14	7314153000613	30	47
1RM-15	7314153000620	30	47
1RM-16	7314153000637	30	47
1RM-17	7314153000644	30	47
1RM-18	7314153000651	30	47
1RM-19	7314153000668	30	47
1RM-21	7314150214495	30	47
1RM-22	73141530005915	30	47
1RM-24	73141530005922	30	47
1RM-27	7314153014177	20	47
1RM-30	7314153014184	20	47
1RM-32	7314153014191	20	47
1RM-6	7314153014146	60	47
1RM-7	7314153014153	60	47
1RM-8	7314153000552	60	47
1RM-9	7314153000569	60	47
1RM/S5	7314150225514	10	48
1RM/SH12	7314150219780	10	48
1RM/SH6	7314150219773	20	48
1RM/SH8	7314150223015	1	48
1RMA-10-1/4-BIT	7314153014634	1	50
1RMA-10-1/4-SQ	7314153014603	1	50
1RMA-13-10-BIT	7314150223008	1	50
1RMA-13-3/8-SQ	7314153014610	1	50
1RMA-13-5/16-BIT	7314153014641	1	50
1RMA-19-1/2-SQ	7314153014627	1	50
1RMA-19-1/4-SQ	7314150190638	100	50
1RMA/S4	7314153014658	30	50
1RMA/S8	7314153014665	1	48
1RZ-1/2	7314153014245	60	47
1RZ-1/4	7314150153725	50	47
1RZ-11/16	7314153014269	30	47
1RZ-11/32	7314150358915	60	47
1RZ-15/16	7314150358939	30	47
1RZ-3/4	7314153014276	30	47
1RZ-3/8	7314153014214	60	47
1RZ-5/16	7314153014207	60	47
1RZ-5/8	7314153014252	30	47
1RZ-7/16	7314153014221	60	47
1RZ-7/8	7314150358922	30	47
1RZ-9/16	7314153014238	30	47
1RZ/SH8	7314150223022	1	48
1Z-1	7314150375189	10	43
1Z-1/2	7314150375103	10	43
1Z-11/16	7314150375134	10	43
1Z-11/32*	7314150375073	10	43
1Z-13/16	7314150375158	10	43
1Z-15/16	7314150375172	5	43
1Z-3/16	7314150375028	20	43
1Z-3/4	7314150375141	10	43
1Z-3/8	7314150375080	10	43
1Z-5/16	7314150375066	10	43
1Z-5/8	7314150375127	10	43
1Z-7/16	7314150375097	10	43
1Z-7/32*	7314150375035	20	43
1Z-7/8	7314150375165	10	43
1Z-9/16	7314150375110	10	43
1Z-9/32	7314150375059	20	43
2-21-51	7315962500011	5	619
2-300-14-0-0	7311518044138	10	33





2-300-14-2-0	7311518044145	10	33
2-300-14-4-0	7311518108786	10	33
2-300-14-D-1P	7311518189105	10	36
2-300-16-0-0	7311518020491	10	33
2-300-16-1-0	7311518020507	10	33
2-300-16-2-0	7311518020514	10	33
2-300-16-4-0	7311518020521	10	33
2-300-16-D-1P	7311518189129	10	36
2-300-18-0-0	7311518190545	10	33
2-300-18-2-0	7311518190552	10	33
2-301-14-0-0	7311518190569	10	33
2-301-14-2-0	7311518108748	10	33
2-301-14-D-1P	7311518189136	1	36
2-301-16-0-0	7311518108755	10	33
2-301-16-1-0	7311518020538	10	33
2-301-16-2-0	7311518020545	10	33
2-302-14-0-0	7311518044152	10	34
2-302-14-2-0	7311518044169	10	34
2-302-14-4-0	7311518108793	10	34
2-302-14-D-1P	7311518189150	10	36
2-302-16-0-0	7311518108762	10	34
2-302-16-1-0	7311518020552	10	34
2-302-16-2-0	7311518020569	10	34
2-302-16-4-0	7311518108809	10	34
2-302-16-D-1P	7311518189167	10	36
2-302-18-0-0	7311518190613	10	34
2-302-18-2-0	7311518190620	10	34
2-303-14-2-0	7311518044176	10	34
2-303-14-D-1P	7311518189174	10	36
2-303-16-0-0	7311518108779	10	34
2-303-16-1-0	7311518020576	10	34
2-303-16-2-0	7311518020583	10	34
2-303-16-4-0	7311518108830	10	34
2-303-16-D-1P	7311518189198	1	36
2-303-18-0-0	7311518190644	10	34
2-303-18-2-0	7311518190668	10	34
2-304-14-0-0	7311518044183	10	33
2-304-14-2-0	7311518044190	10	33
2-304-14-4-0	7311518108878	10	33
2-304-14-D-1P	7311518189204	10	36
2-304-16-0-0	7311518020590	10	33
2-304-16-1-0	7311518020606	10	33
2-304-16-2-0	7311518020613	10	33
2-304-16-4-0	7311518020620	10	33
2-304-16-D-1P	7311518189211	10	36
2-304-18-0-0	7311518190712	10	33
2-304-18-2-0	7311518190736	10	33
2-305-16-1-0	7311518020637	10	34
2-305-16-2-0	7311518108908	10	34
2-306-14-D-1P	7311518189228	1	36
2-306-16-1-0	7311518020644	10	34
2-306-16-2-0	7311518108854	10	34
2-307-14-0-0	7311518044206	10	34
2-307-14-2-0	7311518044213	10	34
2-307-14-4-0	7311518108885	10	34
2-307-14-D-1P	7311518189235	10	36
2-307-16-0-0	7311518020651	10	34
2-307-16-1-0	7311518020668	10	34
2-307-16-2-0	7311518020675	10	34
2-307-16-4-0	7311518020682	10	34
2-307-16-D-1P	7311518189242	10	36
2-307-18-0-0	7311518190965	10	34
2-307-18-2-0	7311518190972	10	34
2-308-14-2-0	7311518044220	10	34
2-308-14-D-1P	7311518189259	1	36
2-308-16-0-0	7311518108861	10	34
2-308-16-1-0	7311518020699	10	34
2-308-16-2-0	7311518020705	10	34
2-309-16-2-0	7311518108946	10	34
2-309-16-4-0	7311518191054	10	34
2-313-16-0-0	7311518191177	10	34
2-470-14-0-0	7311518191191	10	34
2-470-14-2-0	7311518109080	10	35
2-470-14-4-0	7311518191207	10	35
2-470-16-1-0	7311518010942	10	35
2-470-16-2-0	7311518109097	10	35
2-471-16-1-0	7311518010959	5	35
2-472-14-0-0	7311518191214	5	35
2-472-14-2-0	7311518109103	5	36
2-472-16-0-0	7311518191238	5	36
2-472-16-1-0	7311518010966	5	36
2-472-16-2-0	7311518108922	5	36
204030150	8413345400855	12	538
204030160	8413345400862	12	538
204030180	8413345400879	12	538
204530140	8413345097918	12	538
204550130	8413345097956	6	538
2045A3000	8413345097932	12	539
2047-0.8-4	7314151060459	5	234
2047-1-5.5	7314151060473	5	234
2047-1.2-8	7314151060480	5	234
2047-1.6-10	7314151060497	1	234
2047-2-12	7314151060503	1	234
2047PR-1-2	7314151060558	5	234
2047PR-3-4	7314151060565	5	234
2047PZ-1-2	7314150216390	5	234



2058/S26	7314151849276	30	174
2058/S26-2	7314151849283	1	175
2058/S26AF	7314150516308	1	175
208	7311518017545	5	544
209027040	8413345400947	12	538
209227060	8413345400961	12	538
209228100	8413345099233	12	538
209250100	8413345099585	6	538
210	7315965100379	10	544
2100PD-150	7314150205691	5	238
2101D-125	7314150106387	5	236
2101D-125IP	7314150106431	5	236
2101D-140	7314150106394	5	236
2101D-140IP	7314150106325	5	236
2101D-160	7314150106400	5	236
2101D-160IP	7314150106318	5	236
2101D-180	7314150106417	5	236
2101D-180IP	7314150106448	5	236
2101G-125	7314150106462	5	236
2101G-125IP	7314150106516	5	236
2101G-125IPD	7314150335039	5	236
2101G-140	7314150106479	5	236
2101G-140IP	7314150106288	5	236
2101G-140IPD	7314150335053	5	236
2101G-160	7314150106486	5	236
2101G-160IP	7314150106295	5	236
2101G-160IPD	7314150335060	5	236
2101G-180	7314150106493	5	236
2101G-180IP	7314150106523	5	236
2101G-180IPD	7314150335077	5	236
2101GC-125IP	7314150106547	5	236
2101GC-140IP	7314150106554	5	236
2101GC-160IP	7314150106561	5	236
2101GC-180IP	7314150106578	5	236
2101PG-160	7314150113972	5	236
2101S-140	7314150106592	3	486
2101S-160	7314150106608	3	486
2101S-180	7314150106615	3	486
2101S-200	7314150106622	3	487
211035180	8413345000147	5	539
211042210	8413345000154	5	539
212027180	8413345000178	5	539
212033220	8413345129435	8	539
212202500	8413345110266	10	539
212302900	8413345110280	10	540
212502150	8413345110303	10	540
212602150	8413345110327	10	540
212602800	8413345129404	1	540
212704350	8413345122184	6	539
213026140	8413345000185	5	539
2145020D0	8413345097994	1	539
2145020L0	8413345098045	1	539
2145025C0	8413345098083	1	539
2145025D0	8413345098007	1	539
2145025L0	8413345098052	1	539
2145030D0	8413345098014	1	539
2145030L0	8413345098069	1	539
2145035D0	8413345098021	1	539
2145035L0	8413345098076	1	539
2145039C0	8413345098090	1	539
2145PD-150	7314150114009	5	239
215-150	7311518017576	1	546
215000030	8413345131971	12	537
215000040	8413345131988	12	537
215000050	8413345131995	12	537
215000060	8412243557944	12	537
215000070	8413345132008	12	537
215000080	8413345132015	12	537
215000090	8413345132022	12	537
215000100	8413345132039	12	537
215000120	8413345132046	12	537
215500300	7314150220120	12	537
215500400	8413345122627	12	537
215500500	8413345122641	12	537
215500600	8413345122665	12	537
215500700	8413345122689	12	537
215500800	8413345122702	12	537
215500900	8413345137478	12	537
215501000	8413345122726	12	537
216-150-R	7311518017583	1	546
216-300-R	7311518017798	1	546
216000300	8413345403658	12	537
216000400	8413345403665	12	537
216000500	8413345403672	12	537
216000600	8413345403689	12	537
216000700	8413345403696	12	537
216000800	8413345403702	12	537
216000900	8413345403719	12	537
216001000	8413345403726	12	537
216001200	8413345403740	12	537
216100040	8413345132053	12	537
216100060	8413345132091	12	537
216100080	8413345132060	12	537
216100100	8413345132077	12	537
216100120	8413345132084	12	537
216500300	8413345407274	12	537



216500500	8413345407281	12	537
216500750	8413345407298	12	537
216501000	8413345407304	12	537
2171G-140	7314150116232	5	238
2171G-160	7314150116133	5	238
2171G-180	7314150116140	5	238
2171V-160	7314150126798	2	487
2171V-180	7314150126804	2	487
2171V-200	7314150466009	2	487
218	7311518017521	10	545
218-BULK	7311518140946	150	545
219	7311518140953	120	545
219001000	8413345029865	5	537
219001200	8413345029872	5	537
219001400	8413345029889	5	537
219001600	8413345029896	5	537
219002000	8413345029902	5	537
2190PD-150	7314150114016	5	241
219201000	8413345029667	5	537
219201200	8413345029674	5	537
219201400	8413345029681	5	537
219201600	8413345029698	5	537
219202000	8413345029704	5	537
219302500	8413345129466	10	537
219303000	8413345129473	10	537
219303500	8413345129480	10	537
21HDD-140	7314150231256	5	237
21HDD-140IP	7314150231263	5	237
21HDD-160	7314150231270	5	237
21HDD-160IP	7314150231287	5	237
21HDD-180	7314150231294	5	237
21HDD-180IP	7314150231300	5	237
21HDD-200	7314150231317	5	237
21HDD-200IP	7314150231324	5	237
21HDG-140	7314150231331	5	236
21HDG-140A	7314150237654	5	237
21HDG-140IP	7314150231348	5	236
21HDG-160	7314150231355	5	236
21HDG-160A	7314150237661	5	237
21HDG-160IP	7314150231362	5	236
21HDG-180	7314150231379	5	236
21HDG-180A	7314150237678	5	237
21HDG-180IP	7314150231386	5	236
21HDG-200	7314150231409	5	236
21HDG-200A	7314150238439	5	237
21HDG-200IP	7314150231416	5	236
21HDGC-140IP	7314150231423	5	237
21HDGC-160IP	7314150231430	5	237
21HDGC-180IP	7314150231447	5	237
21HDGC-200IP	7314150231454	5	237
221 D	7314150037070	5	251
221201200	8413345029711	5	538
221202000	8413345029728	5	538
221203000	8413345029735	5	538
221301200	8413345029742	5	538
221302000	8413345029759	5	538
221303000	8413345029766	5	538
222 D	7314150037087	5	251
22209004B	8413345401333	1	343
2223 D-150	7314150033591	5	255
2223 G-150	7314150113651	5	255
2223 S-150	7314150032983	3	488
2223V-160	7314150134113	2	489
223 D	7314150037094	5	251
2233 D-160	7314150114023	5	241
2233 D-200	7314150114030	5	241
2233 D-240	7314150114047	5	241
2233D-160IP	7314150114054	5	241
2233D-200IP	7314150114061	5	241
2233D-240IP	7314150114078	5	241
2235-160	7314150179695	1	242
224 D	7314150037100	5	251
225 D	7314150037117	5	251
225-PLUS	7311518029708	5	544
2250V-170	7314150128730	2	487
2250V-230	7314150128747	2	487
227-22	7314150419845	1	126
227-24	7314150419852	1	126
227-27	7314150419869	1	126
227-30	7314150419876	1	126
227-32	7314150419883	1	126
227-34	7314150419890	1	126
227-36	7314150419906	1	126
227-41	7314150419913	1	126
227-46	7314150419920	1	126
228	7311518014995	80	545
228-15-5P	7311518031442	10	546
228-22	7314150420070	1	127
228-24	7314150420087	1	127
228-27	7314150420094	1	127
228-30	7314150420100	1	127
228-32	7314150420117	1	127
228-32-100P	7311518150990	1	546
228-32-10P	7311518010867	10	546
228-32-5P	7311518031459	10	546
228-34	7314150420124	1	127

* Until stocks last



228-36	7314150420131	1	127
228-41	7314150420148	1	127
228-46	7314150420155	1	127
228-BULK	7311518009069	5	545
228-SD	7311518277048	24	159
228-SET-SD	7314150217946	1	160
229-SD	7311518277055	24	159
22F-3/4	7314150419821	1	125
22R-3/4	7314150419838	1	125
23-15	7311518274665	10	619
23-21	7311518012274	10	619
23-24	7311518003852	10	619
23-30	7311518003869	10	619
23-32	7311518003876	10	619
23-36	7311518003883	10	619
230-SD	7311518280956	25	159
2308B0000*	8413345091626	6	538
232-SD	7314150214839	1	160
233-300	7311518044015	5	553
233-300-A	7311518044039	5	553
233-400	7311518044022	5	553
2339 D	7314150032792	3	240
2339 DIP	7314150103508	5	240
2339-220	7314150442461	3	240
2339-220IP	7314150101061	5	240
2339-250IP	7314150101078	5	240
2339-280IP	7314150101948	5	240
2339-300IP	7314150123865	6	240
2339D-300	7314150411245	5	240
2339D-300IP	7314150411238	6	240
234-A1	7311518013653	1	553
234-A2	7311518013660	1	553
234-SD	7314150214846	25	160
234-W1	7311518013608	10	553
234-W2	7311518013615	10	553
234-W3	7311518013622	10	553
238	7311518011314	60	545
239	7311518010874	150	545
2420 G-125	7314150102525	5	248
2420G-125IP	7314150447091	5	248
2421 D-140IP	7314150101979	5	248
2421 D-160IP	7314150101986	5	248
2421 D-180IP	7314150101993	5	248
2421 G-140	7314150102532	5	248
2421 G-140IP	7314150102006	5	248
2421 G-160	7314150102549	5	248
2421 G-160 IP	7314150100576	5	248
2421 G-180	7314150102556	5	248
2421 G-180 IP	7314150100583	5	248
2421GC-140IP	7314150447107	5	248
2421GC-160IP	7314150447114	5	248
2421GC-180IP	7314150233229	5	248
2421S-140	7314150447121	3	488
2421S-160	7314150447138	3	488
2421S-180	7314150447145	3	488
2421V-160	7314150126774	2	488
2427 D-160	7314150032846	5	246
2427 D-200	7314150169030	5	246
2427 G-160	7314150100408	5	246
2427 G-160 IP	7314150100743	5	246
2427 G-200	7314150100415	5	246
2427 G-200 IP	7314150100750	5	246
2427 GC-160IP	7314150102051	5	246
2427 GC-200IP	7314150102075	5	246
2427 S-200	7314150033027	3	488
2427S-160	7314150447008	3	488
2427V-200	7314150126903	2	488
2430 D-140	7314150032853	5	245
2430 D-140 IP	7314150100774	5	245
2430 D-160	7314150032860	5	245
2430 D-160 IP	7314150100781	5	245
2430 D-200	7314150032884	5	245
2430 D-200 IP	7314150100804	5	245
2430 G-140	7314150102563	5	244
2430 G-140 IP	7314150102143	5	244
2430 G-160	7314150024070	5	244
2430 G-160 IP	7314150100811	5	244
2430 G-200	7314150100422	5	244
2430 G-200 IP	7314150100835	5	244
2430 GC-140 IP	7314150102150	5	245
2430 GC-160 IP	7314150102167	5	245
2430 GC-200 IP	7314150102174	5	245
2430 S-160	7314150206742	3	488
2430 S-200	7314150033010	3	488
2430S-140	7314150446995	3	488
2430V-160	7314150126880	2	488
2430V-200	7314150126897	2	488
2431G-125	7314150447015	5	245
2431G-125IP	7314150447053	5	245
2431G-140	7314150447022	5	245
2431G-140IP	7314150447060	5	245
2431G-160	7314150447039	5	245
2431G-160IP	7314150447077	5	245
2431G-180	7314150447046	5	245
2431G-180IP	7314150447084	5	245
244-20-U7/8-HP	7311518012519	10	551



244-22-U7/8-HP



244-22-U7/8-HP	7311518012526	10	551
2446	7314150128648	15	569
2446-BL	7314150508242	15	570
2446-EL	7314150270736	12	570
2446-EL-HELP	7314150394500	12	570
2446-ELL	7314150370153	12	570
2446-ELR	7314150370146	12	570
2446-LAP	7314150508228	15	569
2446-LINO	7314150270750	12	570
2446-OV	7314150313662	15	570
2446-SAFE	7314150453078	15	570
2448	7314150136049	12	560
2449	7314150194056	12	560
244P-20-U7-HP	7311518235499	4	553
244P-22-U7-HP	7311518235482	10	553
2460	7314151063467	1	254
2461 C19	7314151063498	1	253
2461 C40	7314151063504	1	253
2461 C8	7314151063481	1	253
2463 D19	7314151063511	1	253
2463 D40	7314151063528	1	253
2463 D8	7314151588878	1	253
2464 A10	7314151063535	1	253
2464 A19	7314151063542	1	253
2464 A3	7314151406516	1	253
2464 A40	7314151063559	1	253
2465D-200	7314150120826	1	254
2466 B10	7314151063573	1	254
2466 B19	7314151063580	1	254
2466 B3	7314151406868	1	254
2466 B40	7314151063597	1	254
247-24	7314150367078	1	123
247-27	7314150367085	1	123
247-30	7314150367092	1	123
247-32	7314150367108	1	123
247-34	7314150367115	1	123
247-36	7314150367122	1	123
247-41	7314150367139	1	123
247-46	7314150367146	1	123
247-50	7314150367153	1	123
247-55	7314150367160	1	123
247-60	7314150367177	1	123
2470 G-160	7314150116188	5	246
2470 G-200	7314150116195	5	246
2471 G-160	7314150116225	5	249
2471 G-180	7314150134939	5	249
2477 G-200	7314150116201	5	247
2477G-160	7314150134977	5	247
248-24	7314150367818	1	124
248-27	7314150367825	1	124
248-30	7314150367832	1	124
248-32	7314150367849	1	124
248-34	7314150367856	1	124
248-36	7314150367863	1	124
248-41	7314150367870	1	124
248-46	7314150367887	1	124
248-50	7314150367894	1	124
248-55	7314150367900	1	124
248-60	7314150367917	1	124
2484-20	7314150233250	1	364
2484-30	7314150233267	1	364
2484-45	7314150233274	1	364
2484-60	7314150233281	1	364
2484/S4	7311518276553	10	364
2484T-20	7314150455102	1	364
2484T-30	7314150455119	1	364
2484T-45	7314150455126	1	364
2484T-60	7314150455133	1	364
2484T/S4	7314150455096	1	364
2485	7314150242382	1	342
2487	7311518276058	12	524
2488	7311518276072	12	538
2489	7311518276065	12	538
24A-14	7314150368235	1	125
24A-27	7314150368242	1	125
24F-1	7314150366231	1	122
24F-3/4	7314150366224	1	122
24R-1	7314150365951	1	121
24R-3/4	7314150365944	1	121
24T-1	7314150366156	1	122
24T-3/4	7314150366149	1	122
24W	7314150368266	1	125
2500-16-XT-HP	7311518160159	4	551
2500-19-XT-HP	7311518160722	4	551
2500-22-XT-HP	7311518140922	4	551
2500-24-XT7-HP	7311518181338	4	551
250400010	7314150314430	1	540
250400020	7314150393008	1	540
250400030	7314150393015	1	540
250501800	8413345128964	50	540
2509	7314151064280	50	365
2520	7314150023752	1	241
2521 G-140	7314150100293	5	249
2521 G-160 IP	7314150100620	5	249
2521D-140IP	7314150447176	5	249
2521D-160IP	7314150447183	5	249



2521G-140IP	7314150447169	5	249
2521G-160	7314150447152	5	249
2521S-140	7314150447190	3	488
2521S-160	7314150447206	3	488
2521V-160	7314150126781	2	488
2530	7314150326761	1	365
2530-40	7314151317294	5	524
2535F0	7314150402236	1	365
2535F1	7314151064495	1	365
2535F2	7314150233854	1	365
2535F3	7314150180233	1	365
2535L	7314150125357	12	365
255-17/34	7314150272372	2	549
255-34	7314150272365	2	549
2555	7311518276041	1	305
256-26	7311518000080	4	549
2600-16-XT11-HP	7311518239527	4	550
2600-19-XT-HP	7311518160760	4	551
2600-22-XT-HP	7311518160777	4	551
2620-80	7311518200947	1	241
2628 D-160	7314150123193	5	243
2628 D-180	7314150042661	5	243
2628 D-200	7314150123315	5	243
2628 G-160	7314150042999	5	243
2628 G-160IP	7314150055357	5	243
2628 G-180	7314150042678	5	243
2628 G-180IP	7314150044030	5	243
2628 G-200	7314150103539	5	243
2628 GC-160IP	7314150101863	5	243
2628 GC-180IP	7314150101870	5	243
2628 GC-200IP	7314150101887	5	243
2628 S-160	7314150206735	3	487
2628 S-180	7314150044054	3	487
2628 S-200	7314150043002	3	487
2628G-200IP	7314150101085	5	243
2629G-160	7314150446933	5	243
2629G-160IP	7314150446964	5	243
2629G-180	7314150446940	5	243
2629G-180IP	7314150446971	5	243
2629G-200	7314150446957	5	243
2629G-200IP	7314150446988	5	243
2630DC-160IP	7314150446896	5	244
2630DC-180IP	7314150446902	5	244
2630DC-200IP	7314150446919	5	244
2630GC-160IP	7314150180165	5	243
2630GC-180IP	7314150180172	5	243
2630GC-200IP	7314150180189	5	243
2630SC-180	7314150446926	3	487
2632	7314151065706	1	364
2633/S4	7311518276942	12	523
2633HD/S6	7314150205783	1	311
2633HD1	7314150230464	1	311
2633HD2	7314150230471	1	311
2633HD3	7314150230488	1	311
2633HD4	7314150230495	1	311
2633HD5	7314150230501	1	311
2633HD6	7314150230518	1	311
2633L/S4	7311518276959	12	523
2635	7311518276348	1	595
2640D-160	7314150123766	10	244
2640D-180	7314150123773	5	244
2640D-200	7314150123797	5	244
2646	7314151304638	1	239
2646 A	7314151304645	1	239
2646 AK	7314151396619	1	239
2646 K	7314151495862	1	239
2646 M	7314151487928	1	238
2646 MF	7314151573683	1	249
2646 MS	7314151573768	1	250
2646 R	7314151304706	1	238
2646 RA	7314151834838	1	238
2646 RK	7314151496678	1	238
2648	7314151304713	1	239
2648 A	7314151304720	1	239
2649	7314150058013	1	238
2650	7314151065829	1	252
2650 B	7314151065843	1	252
2656	7314151304737	1	241
2656 R	7314151473976	1	247
2656 S	7314150058044	1	246
2666	7314150058006	1	238
2666 FK	7314151066079	1	239
2674 NB	7314151066321	1	238
2674 NVDE	7314151498535	1	487
2676 B	7314151066390	1	238
2678 B	7314151066468	1	238
2678 G-160	7314150116157	5	244
2678 G-180	7314150116164	5	244
2678 G-200	7314150116171	5	244
2678V-160	7314150126835	2	487
2678V-180	7314150126842	2	487
2678V-200	7314150126859	2	487
268	7311518017538	5	545
2681	7311518276706	12	266
2681-1	7314150116980	1	267
2688D-250	7314150123520	3	244



2690	7314150411108	10	267
26S-1216	7314151830236	8	61
26S-16	7314150345588	5	61
26S-610	7314151830229	10	61
2700-22-XT7-HP	7311518191672	4	553
2700-24-XT7-HP	7311518191665	4	553
2704A	7314151066963	1	566
2705R	7314151821470	1	566
2720	7314150179701	1	242
2720-SH	7314150179718	1	242
277-30	7314150367184	1	123
277-32	7314150367191	1	123
277-34	7314150367207	1	123
277-36	7314150367214	1	123
277-41	7314150367221	1	123
277-46	7314150367238	1	123
277-50	7314150367245	1	123
277-55	7314150367252	1	123
277-60	7314150367269	1	123
278-30	7314150367924	1	124
278-32	7314150367931	1	124
278-34	7314150367948	1	124
278-36	7314150367955	1	124
278-41	7314150367962	1	124
278-46	7314150367979	1	124
278-50	7314150367986	1	124
278-55	7314150367993	1	124
278-60	7314150368006	1	124
2784-2.5	7314150215607	1	221
2784-3.5	7314150215614	1	221
2784-4.5	7314150215621	1	221
2787 F	7314151474270	1	239
2787 G	7314150058020	1	239
27A-24	7314150368259	1	125
27F-1	7314150366248	1	122
27M-10-11	7314150180523	10	60
27M-12-13	7314150180547	10	60
27M-13-17	7314150180790	10	60
27M-14-15	7314150180554	10	60
27M-16-17	7314150180561	10	60
27M-16-18	7314150180806	10	60
27M-18-19	7314150180578	10	60
27M-20-22	7314150180585	10	60
27M-21-23	7314150180592	5	60
27M-21-24	7314150180813	5	60
27M-24-26	7314150180608	5	60
27M-24-27	7314150180820	5	60
27M-25-28	7314150180622	5	60
27M-27-29	7314150180639	5	60
27M-30-32	7314150180646	5	60
27M-6-7	7314150180509	10	60
27M-8-9	7314150180516	10	60
27M/10	7314150180677	1	61
27M/12	7314150180684	1	61
27M/12T	7314150180783	1	60
27M/6	7314150180653	1	60
27M/8	7314150180660	1	61
27M/8T	7314150180776	1	60
27R-1	7314150365968	1	121
27T-1	7314150366163	1	122
28-29/S4	7314150179688	1	254
2800 N	7314151318338	1	242
2800-140	7314150121632	3	252
2800-150	7314150034567	3	252
2800-180	7314150034581	3	252
2800-225	7314150034604	3	252
2800-300	7314150122622	1	252
2801 N	7314151318352	1	242
2804	7314151692698	1	242
2805-280	7314151826123	1	242
2820EF1	7314150122042	12	572
2820EF2	7314150122059	8	572
2820EF3	7314150122066	1	572
2820EF4	7314150122073	1	572
2820EK	7314150122035	6	572
2820EK-01	7314150270743	12	571
2820VBC	7314150121915	1	487
2820VDE	7314151605476	10	491
2820VFP	7314150121922	1	491
2820VG05	7314150121953	1	491
2820VG10	7314150121960	1	491
2820VGCOT	7314150121977	1	491
2820VM	7314150121946	1	491
2820VP	7314150121885	2	490
2820VPC	7314150121892	2	491
2820VTEE	7314150121939	1	491
2855	7314151825805	1	268
2855 D	7314151822569	1	268
2856-10*	7314150437214	1	268
2856-8*	7314150437207	1	268
2890-125	7314150122639	3	252
2890-140	7314150034550	3	252
2890-180	7314150034574	3	253
2890-210	7314150034598	3	253
2890-300	7314150122646	1	253
28M-10	7314151834678	5	58

* Until stocks last



28M-11	7314151834685	5	58
28M-12	7314151834692	5	58
28M-13	7314151834708	5	58
28M-14	7314151834715	5	58
28M-15	7314151834722	5	58
28M-16	7314151834739	5	58
28M-17	7314151834746	5	58
28M-18	7314151834753	3	58
28M-19	7314151834760	3	58
28M-20	7314150122561	3	58
28M-21	7314151834777	3	58
28M-22	7314151834784	3	58
28M-23	7314150122578	3	58
28M-24	7314151834791	3	58
28M-25	7314150122585	3	58
28M-26	7314150122592	3	58
28M-27	7314151834807	3	58
28M-28	7314150122608	1	58
28M-29	7314150122615	1	58
28M-30	7314151834814	1	58
28M-32	7314151834821	1	58
28M-6	7314151834630	5	58
28M-7	7314151834647	5	58
28M-8	7314151834654	5	58
28M-9	7314151834661	5	58
28M/11	7314151838126	1	59
28M/12	7314151838133	1	59
28M/15	7314151838140	1	59
28M/8	7314151838119	1	59
28MV-10	7314150121298	2	489
28MV-11	7314150121304	2	489
28MV-12	7314150121311	2	489
28MV-13	7314150121328	2	489
28MV-14	7314150121335	2	489
28MV-15	7314150121342	2	489
28MV-16	7314150121359	2	489
28MV-17	7314150121366	2	489
28MV-18	7314150121373	2	489
28MV-19	7314150121380	2	489
28MV-20	7314150121397	2	489
28MV-21	7314150121403	2	489
28MV-22	7314150121410	2	489
28MV-8	7314150121274	2	489
28MV-9	7314150121281	2	489
29-B	7311518277703	1	323
2900-140	7314150121045	3	253
2900-150	7314150034499	3	253
2900-180	7314150034512	3	253
2900-215	7314150034536	3	253
2900-300	7314150121076	1	253
2928-1	7314150056583	1	254
2928-160	7314150056514	1	254
2928-2	7314150056590	1	254
2928-200	7314150056521	1	254
2928-250	7314150056538	1	254
2928-3	7314150056606	1	254
2928-4	7314150056613	1	254
2949-190IP	7314150123926	1	266
2949-200IP	7314150123940	1	266
2949-240IP	7314150123957	1	266
2949-250IP	7314150123971	1	266
2949-L075	7314150440559	1	266
2949-L120	7314150440566	1	266
2949-L200	7314150440573	1	266
2950-250	7314150124039	1	264
2951-140	7314150124084	1	262
2951-180	7314150102204	1	262
2951-250	7314150102211	1	262
2951-300	7314150102228	1	262
2951-S05	7314150447299	1	265
2951-S07	7314150447305	1	265
2951-S10	7314150447312	1	265
2951-S12	7314150447329	1	265
2952-165	7314150103836	1	263
2952-235	7314150103843	1	263
2953-140	7314150124046	1	262
2953-200	7314150124053	1	262
2953-250	7314150124060	1	262
2953-300	7314150124077	1	262
2955-250	7314150102235	1	263
2956-290	7314150413690	1	265
2957-250	7314150102259	1	263
2958-140	7314150124107	1	263
2958-200	7314150124114	1	263
2958-250	7314150102242	1	263
296	7311518034146	1	555
2960-280	7314150412808	1	264
2962-8-150	7314150412815	1	265
2962-8-230	7314150413706	1	265
2962-8-300	7314150413713	1	265
2963-280	7314150102280	1	264
2963-450	7314150124138	1	264
2963-630	7314150124145	1	264
2964-160	7314150124183	1	264
2964-280	7314150102297	1	264
2964-450	7314150124190	1	264



2964-600



2964-600	7314150124206	1	264
2965-200	7314150124152	1	265
2965-280	7314150102266	1	265
2966-280	7314150102273	1	265
2967-180	7314150102396	1	263
2968-190	7314150124091	1	263
2968-235	7314150103850	1	263
2970G-200	7314150134946	5	244
2971G-250	7314150117154	5	251
2979 D-180	7314150034246	5	249
2990-125	7314150121250	3	253
2990-140	7314150034482	3	253
2990-180	7314150034505	3	253
2990-200	7314150034529	3	253
2990-300	7314150121267	1	253
2997-250	7314150124237	1	266
2997-300	7314150124244	5	265
2998-250	7314150124213	1	264
2998-SHN	7314150447275	1	264
2999-250	7314150124169	1	264
2999-SHN	7314150447282	1	264
29M-10	7314150122318	5	59
29M-11	7314150122325	5	59
29M-12	7314150122332	5	59
29M-13	7314150122349	5	59
29M-14	7314150122356	5	59
29M-15	7314150122363	5	59
29M-16	7314150122370	5	59
29M-17	7314150122387	5	59
29M-18	7314150122394	3	59
29M-19	7314150122400	3	59
29M-20	7314150122417	3	59
29M-21	7314150122424	3	59
29M-22	7314150122431	3	59
29M-23	7314150122448	3	59
29M-24	7314150122455	3	59
29M-25	7314150122462	3	59
29M-26	7314150122479	3	59
29M-27	7314150122486	3	59
29M-28	7314150122493	1	59
29M-29	7314150122509	1	59
29M-30	7314150122516	1	59
29M-32	7314150122523	1	59
29M-6	7314150122271	5	59
29M-7	7314150122288	5	59
29M-8	7314150122295	5	59
29M-9	7314150122301	5	59
29M10	7314150122547	1	59
29M14	7314150122554	1	59
29M8	7314150122530	1	59
2M-10-11	7314151001223	5	54
2M-10-13	7314151001513	5	54
2M-12-13	7314151001230	5	54
2M-13-17	7314151343972	5	54
2M-14-15	7314151001247	5	54
2M-16-17	7314151001254	5	54
2M-16-18	7314151001575	5	54
2M-17-19	7314151000844	5	54
2M-18-19	7314151001261	5	54
2M-19-22	7314151000868	5	54
2M-20-22	7314151001278	5	54
2M-21-23	7314151001285	5	54
2M-22-24	7314151001612	5	54
2M-24-26	7314151001292	5	54
2M-24-27	7314151000899	5	54
2M-25-28	7314151001308	5	54
2M-27-29	7314150205332	5	54
2M-27-30	7314151001636	5	54
2M-27-32	7314151001322	5	54
2M-30-32	7314151000929	5	54
2M-32-36	7314151001667	1	54
2M-36-41	7314151001681	1	54
2M-41-46	7314151001704	1	54
2M-46-50	7314151001711	1	54
2M-6-7	7314151001209	5	54
2M-8-10	7314151001506	5	54
2M-8-9	7314151001216	5	54
2M10T	7314150212996	1	54
2M12T	7314151001414	1	55
2M8T	7314151001391	1	54
2M/S8	7314151827335	1	54
2MV-10	7314150121113	5	489
2MV-11	7314150121120	5	489
2MV-12	7314150121137	5	489
2MV-13	7314150121144	5	489
2MV-14	7314150121151	5	489
2MV-15	7314150121168	5	489
2MV-16	7314150121175	5	489
2MV-17	7314150121182	3	489
2MV-18	7314150121199	3	489
2MV-19	7314150121205	3	489
2MV-21	7314150121212	3	489
2MV-22	7314150121229	3	489
2MV-23	7314150121236	3	489
2MV-24	7314150121243	3	489
2MV-6	7314150121069	5	489



2MV-7	7314150121083	5	489
2MV-8	7314150121090	5	489
2MV-9	7314150121106	5	489
2Z-1-1.1/8	7314151001827	1	54
2Z-1.1/16-1.1/4	7314151001834	1	54
2Z-1/2-9/16	7314151001445	1	54
2Z-1/4-5/16	7314151001421	1	54
2Z-13/16-7/8	7314151001797	1	54
2Z-15/16-1	7314151001810	1	54
2Z-3/4-7/8	7314151001773	1	54
2Z-3/8-7/16	7314151001438	1	54
2Z-5/16-3/8	7314151001728	1	54
2Z-5/8-11/16	7314151001452	1	54
2Z-9/16-5/8	7314151001735	1	54
2Z/7T	7314150217373	1	55
3-24-51	7315962500028	5	619
3-330-12-1-0	7311518020712	5	33
3-330-12-2-0	7311518020729	5	33
3-330-14-1-0	7311518020736	5	33
3-330-14-2-0	7311518020743	5	33
3-331-14-1-0	7311518020750	5	33
300-14-F15/16-HP	7311518005955	4	549
301	7311518001384	50	555
301-16	7314150456048	12	272
301-22	7311518293673	12	272
302	7311518013349	30	554
302-15-95	7314150486632	100	273
302-35	7311518293680	6	272
302-511W-12P	7311518207786	1	555
302-51W-12P	7311518013356	1	555
302-53W-12P	7311518013363	1	555
302-55W-12P	7311518013370	1	555
302-57W-12P	7311518013387	1	555
302-59W-12P	7311518207779	1	555
302-6X4P	7311518017590	1	555
302-71M-12P	7311518013394	1	555
302-73M-12P	7311518013400	1	555
302-75M-12P	7311518013417	1	555
302-76-95*	7314150188345	1	272
302-76N	7314150456307	6	272
302-77M-12P	7311518207793	1	555
302-81S-12P	7311518013677	1	555
302-83S-12P	7311518013684	1	555
302-85S-12P	7311518207809	1	555
302-95-SET	7314150456321	1	273
303-5P	7311518031435	10	555
304	7311518265533	10	544
3045/1VDE	7314151783815	1	492
3045V-1	7314150128785	1	492
3045V-2	7314150128792	1	492
3046-REF	7311518276966	1	305
306	7311518265540	10	544
306-10	7314150120246	1	272
306-12	7314150120253	1	272
306-15	7311518297107	12	272
306-15-95	7311518297329	1	273
306-22	7311518297114	12	272
306601500	8413345098700	5	574
306602000	8413345098717	5	574
306603000	8413345217033	5	574
306604000	8413345217095	5	574
306703000	8413345217194	5	574
306704000	8413345098755	5	574
306705000	8413345098762	5	574
306706000	8413345098779	5	574
306708000	8413345098786	5	574
306710000	8413345098793	5	574
306712000	8413345123334	2	574
306715000	8413345123341	2	574
306803000	8413345098809	5	574
306804000	8413345098816	5	574
306805000	8413345098823	2	574
306806000	8413345098830	2	574
306808000	8413345098847	2	574
306810000	8413345098854	2	574
306812000	8413345098861	2	574
306815000	8413345098878	1	574
306820000	8413345098885	1	574
306903000	8413345123402	2	574
306904000	8413345123419	2	574
306905000	8413345123426	2	574
306906000	8413345123433	2	574
306908000	8413345123457	2	574
306910000	8413345123471	2	574
307401B	7314150254958	1	271
307411B	7314150254965	1	271
307421B	7314150254972	1	271
307431B	7314150254989	1	271
307441	7314150235933	1	271
307451	7314150235940	1	271
308504000	8413345035156	1	532
308505000	8413345035194	1	532
308506000	8413345035163	1	532
308508000	8413345035170	1	532
308510000	8413345035187	1	532
3090-20-XT11-HP	7311518181369	4	551



31	7314150004942	5	42
31 IP	7314150004959	50	42
31-T	7314150483709	5	42
31-T IP	7314150483723	50	42
3100TB	7314150125364	1	452
310M-24	7314151829612	1	58
310M-27	7314151829629	1	58
310M-30	7314151829636	1	58
310M-32	7314151829643	1	58
310M-36	7314151829650	1	58
310M-38	7314151829667	1	58
310M-41	7314151829674	1	58
310M-46	7314151829681	1	58
310M-50	7314151829698	1	58
310M-55	7314151829704	1	58
310M-60	7314151829711	1	58
310M-65	7314151829728	1	58
310M-70	7314151829735	1	58
310M-75	7314151829742	1	58
310M-80	7314151829759	1	58
310M-85	7314151829766	1	58
310M-90	7314151829773	1	58
310M-95	7314151829780	1	58
311-32	7314150120215	6	273
3115	7314150055326	1	358
3149-OR	7311518292249	1	447
3149-ORFF1	7314150292479	1	447
3149-ORTS1	7314150292066	1	447
3150-12-XT9-HP	7311518181406	4	548
315M-27	7314150133291	1	58
315M-30	7314150133307	1	58
315M-32	7314150133314	1	58
315M-36	7314150133321	1	58
315M-41	7314150133345	1	58
315M-46	7314150133352	1	58
315M-50	7314150133369	1	58
315M-55	7314150133376	1	58
315M-60	7314150133383	1	58
315M-65	7314150133390	1	58
315M-70	7314150133406	1	58
315M-75	7314150133413	1	58
315M-80	7314150133420	1	58
315Z-1.1/16	7314150133437	1	58
315Z-1.1/2	7314150133505	1	58
315Z-1.1/4	7314150133468	1	58
315Z-1.1/8	7314150133444	1	58
315Z-1.11/16	7314150133529	1	58
315Z-1.13/16	7314150133543	1	58
315Z-1.15/16	7314150133567	1	58
315Z-1.3/16	7314150133451	1	58
315Z-1.3/4	7314150133536	1	58
315Z-1.3/8	7314150133482	1	58
315Z-1.5/16	7314150133475	1	58
315Z-1.5/8	7314150133512	1	58
315Z-1.7/16	7314150133499	1	58
315Z-1.7/8	7314150133550	1	58
315Z-2	7314150133574	1	58
315Z-2.1/16	7314150133581	1	58
315Z-2.1/2	7314150133642	1	58
315Z-2.1/4	7314150133611	1	58
315Z-2.1/8	7314150133598	1	58
315Z-2.15/16	7314150133697	1	58
315Z-2.3/16	7314150133604	1	58
315Z-2.3/4	7314150133673	1	58
315Z-2.3/8	7314150133635	1	58
315Z-2.5/16	7314150133628	1	58
315Z-2.5/8	7314150133666	1	58
315Z-2.7/8	7314150133680	1	58
315Z-2.9/16	7314150133659	1	58
315Z-3	7314150133703	1	58
315Z-3.1/8	7314150133840	1	58
316-1	7311518296216	12	274
316-2	7311518296223	12	274
316-2-95	7311518296278	1	275
317	7311518240936	10	544
317-40	7311518296230	12	275
318-38	7311518296247	1	275
318-54	7311518296254	1	275
3180-14-XT11-HP	7311518181390	4	550
319	7311518240943	5	544
320	7311518265557	10	544
321	7311518001841	5	544
321-18-SB	7311518129125	10	546
321-24-SB	7311518129132	10	546
321-7-SB	7311518129149	10	546
322500300	8413345012829	1	522
322500500	8413345012836	1	522
322500800	8413345012843	1	522
322510300	8413345015899	1	522
322510500	8413345015905	1	522
322510600	8413345137393	1	522
322510700	8413345137409	1	522
322510800	8413345015912	1	522
3240-14-XT11-HP	7311518243005	4	550
325	7311518214852	5	544
325001000	8413345000505	1	522

* Until stocks last



3250010SH	8413345137492	1	522
326000200	8413345000529	1	522
326000300	8413345012881	1	522
326010200	8413345016100	1	522
326020200	8413345016117	1	522
326030200	8413345016124	1	522
327020500	7314150330584	1	522
327020500-SH1	7314150361021	1	523
327020500-SH2	7314150361038	1	523
327020500-SH3	7314150361045	1	523
327020500-SH4	7314150361052	1	523
3280M	7314151071318	1	52
329000330	8413345000741	1	523
329000500	8413345000758	1	523
331-15-23	7311518274658	5	619
331-21-51-KP	7311518003814	5	619
332-21-51	7311518229337	5	619
333	7311518005832	5	619
333-5	7311518005849	10	620
339-6T	7311518128371	4	616
33H	7314150266791	5	42
340-6T	7311518002008	4	616
341	7314150113729	1	270
3416 A	7314150216260	6	255
3416 A SH	7314150410941	1	255
3416 B	7314150411160	10	255
3417 A	7314150216277	12	257
3418 A	7314150216284	1	256
3419 B	7314151812416	1	257
3419 B SH	7314150504381	1	257
342	7314150113736	1	270
343	7314150113743	1	270
344	7314150113750	1	270
349	7311518018924	4	620
3517 A	7314150410910	1	256
3518 A	7314150216376	1	256
3518 A SH	7314150216383	1	256
3518 B	7314150410927	1	256
3520 A	7314150410934	1	256
3520 A SH	7314150410958	1	256
3520 B	7314150411177	10	256
3520 B SH	7314150411207	10	256
3524	7314151073336	1	524
3524L-K	7314151339807	1	524
3525HB	7314151073350	5	524
36	7314150223381	5	579
361-10	7311518295202	1	271
361-12	7311518295219	1	271
361-14	7311518295226	1	271
361-18	7311518295233	1	271
361-24	7311518295240	1	271
361-36	7311518295257	1	271
361-8	7311518295196	1	271
3619 A	7314150411184	10	257
3619 A SH	7314150411214	10	257
3625AR-35	7314150214723	34	582
3625AR-50	7314150214730	18	582
3625AR-60	7314150214747	12	582
3625ARL-35	7314150214754	6	582
3625ARL-50	7314150214761	6	582
3625ARL-60	7314150214778	6	582
3625ARLH-35	7314150218677	80	583
3625ARLH-50	7314150218684	50	583
3625ARLH-60	7314150218691	16	583
3625N-22	7314151073602	6	583
3625N-32	7314151073640	6	583
3625N-40	7314151073688	6	583
3625N-50	7314151073701	6	583
3625NL-22	7314151073831	20	584
3625NL-32	7314151073855	20	584
3625NL-40	7314151073879	20	584
3625NL-50	7314151073886	20	584
3625NLH-32*	7314150247585	1	583
3625PU-105	7314150170098	4	583
3625PU-30	7311518276119	12	583
3625PU-50	7311518276126	6	583
3625PU-60	7311518276133	6	583
3625RM-55	7314150120758	50	584
3625RM-65	7314150120765	40	584
3625RM-75	7314153019820	30	584
3625RM-90	7314150120390	20	584
3625S-28	7314150183906	50	584
3625S-35	7314150183913	30	584
3625S-44	7314150183920	18	584
3625W-22	7314150120406	120	584
3625W-28	7314150120413	1	584
3625W-35	7314150120420	1	584
3625W-44	7314150120437	1	584
3625W-55	7314150120444	12	584
3625WL-22	7314150120451	10	584
3625WL-28	7314150120468	10	584
3625WL-35	7314150120475	10	584
3625WL-44	7314150120482	10	584
3625WL-55	7314150120499	6	584
3625WLH-22	7314150219025	50	584
3625WLH-28	7314150218981	50	584



3625WLH-35



3625WLH-35	7314150218998	80	584
3625WLH-44	7314150219001	50	584
3625WLH-55	7314150219018	16	584
3625Y-22	7314151074074	6	583
3625Y-32	7314151074098	6	583
3625Y-40	7314151074111	6	583
3625Y-50	7314151074128	6	583
3625YL-22	7314151074159	20	583
3625YL-32	7314151074173	20	583
3625YL-35*	7314151074180	1	583
3625YL-40	7314151074197	20	583
3625YL-50	7314151074203	20	583
363-32	7311518295578	1	271
3640-150-C	7314150180691	25	590
3640-175-C*	7314150180707	6	590
3640-200-C	7314150180714	25	590
3640-250-C	7314150180721	20	590
3640-300-C	7314150180738	25	590
3643-100	7314151074654	50	592
3643-120	7314151074678	50	592
3643-150	7314151074685	50	592
3644-120	7314151074708	50	592
3644-125	7314151074722	50	592
3644-130	7314151074746	50	592
3644-150	7314151074760	50	592
3644-165	7314151074777	50	592
3644-180	7314151074791	50	592
3644-200	7314151074807	50	592
3646-115	7314151074937	250	593
3646-125	7314151074944	250	593
3646-150	7314151074951	125	593
3646-165	7314151074968	125	593
3646-180	7314151074975	50	593
3646-200	7314151074982	50	593
3646/6	7314151074999	25	593
3649-125	7314150472413	50	590
3654BMS/7	7314150220816	1	596
3654R	7314151075132	1	593
3656-125	7314150472352	50	590
3656-150	7314150472376	50	590
3656-175	7314150472390	1	590
3656/10	7314151075279	1	594
3658A-2	7314151075293	125	593
3658A-3	7314151075309	125	593
3658A-4	7314151075316	125	593
3658A-5	7314151075323	125	593
3658A-6	7314151075330	125	593
3658A-8	7314151075347	50	593
3658A/6	7314151075354	30	594
3659-0.9	7314151075507	5	593
3659-1.4	7314151075514	5	593
3659-1.8	7314151597351	5	593
3659-2.4	7314151075538	5	593
3659-2.8	7314151597436	5	593
3659-3.4	7314151075552	5	593
3659-3.9	7314151075569	5	593
3659-6.0	7314151075576	5	593
3659/8	7314151075583	1	594
3659/8T	7314151472573	1	594
3680	7314151075835	1	364
3681-11	7314150132980	1	365
3681-16	7314150132997	1	365
3681-20	7314150133000	1	365
3683	7314151075866	1	364
3684-16	7314150133017	1	364
3684-18	7314150133024	1	364
3684-24	7314150133031	1	364
3684-30	7314150133048	1	364
369-BLADE	7311518016531	20	549
370-4	7311518296193	1	271
3717 A	7314150489916	1	257
3718 A	7314150489930	12	257
3719 A	7314150489954	12	257
372-1.1/2	7314150133239	1	271
372-12	7314150133284	1	271
372-2.1/2	7314150133246	1	271
372-4	7314150133253	1	271
372-6	7314150133260	1	271
372-8	7314150133277	1	271
3733-2	7314151834371	50	593
3733-3	7314151834388	50	593
3733-4	7314151834395	50	593
3733-5	7314151834401	50	593
3733-6	7314151834418	50	593
3733S/5	7314150220809	25	594
3734-2	7314151834296	50	593
3734-3	7314151834319	50	593
3734-4	7314151834326	50	593
3734-5	7314151834333	50	593
3734-6	7314151834340	50	593
3734-8	7314151834357	50	593
3734BMS/7	7314150220755	1	596
3734N-10-150	7314150218110	10	593
3734N-2-150	7314150218042	10	593
3734N-3-150	7314150218059	10	593
3734N-4-150	7314150218066	10	593



3734N-5-150	7314150218073	10	593
3734N-6-150	7314150218080	10	593
3734N-7-150	7314150218097	10	593
3734N-8-150	7314150218103	10	593
3734N-9-150	7314150218127	10	593
3734NS/9	7314150218134	10	594
3734S/6	7314151834470	5	594
3735-4-120	7314151834265	50	592
3735-5-120	7314151834272	50	592
3735-5-150	7314151834289	50	592
3735N-2-100	7314150217953	10	592
3735N-4-120	7314150217960	10	592
3735N-5-120	7314150217977	10	592
3735N-6-150	7314150217984	10	592
3735N-8-150	7314150217991	10	592
3735NS/4	7314150218004	25	592
3736M-200	7314150220878	30	591
3736M-250	7314151834142	25	591
3736M-300	7314151834159	10	591
3736M-400	7314151834166	10	591
3736MH-250	7314151834173	10	591
3736MH-300	7314151834180	10	591
3736MH-400	7314151834197	5	591
3736S/6	7314151834463	5	591
3739-250	7314151834203	25	591
3739-300	7314151834210	10	591
3739-400	7314151834227	10	591
3739H-250	7314151834234	15	591
3739H-300	7314151834241	10	591
3739H-400	7314151834258	10	591
3740-100	7314151834005	50	590
3740-125	7314151834012	50	590
3740-150	7314151834029	50	590
3740-175	7314151834036	25	590
3740-200	7314151834043	25	590
3740-250	7314151834050	10	590
3740-300	7314151834067	10	590
3745-150	7314151834081	50	590
3745-175	7314151834098	25	590
3745-200	7314151834104	20	590
3745-250	7314151834111	10	590
3749-125	7314150457915	50	590
375-8	7311518296209	1	271
3750	7314151834128	25	590
3750H	7314151834135	25	591
3756-125	7314150457892	50	590
3756-150	7314150457908	50	590
38-12	7314151831264	5	326
38-16	7314151831271	5	326
38-20	7314151831288	2	326
38-24	7314151831295	1	326
38-8	7314151831257	5	326
380-10	7314150133178	1	271
380-14	7314150133185	1	271
380-18	7314150133192	1	271
380-24	7314150133208	1	271
380-36	7314150133215	1	271
380-48	7314150133222	1	271
3802-300-25-1.25-10	7311518111229	10	20
3802-300-25-1.25-14	7311518111236	10	20
3802-300-25-1.25-6	7311518143299	10	20
3802-300-32-1.60-10	7311518111274	10	20
3802-300-32-1.60-6	7311518111298	10	20
3802-350-25-1.25-10	7311518111335	10	20
3802-350-25-1.25-14	7311518111342	10	20
3802-350-25-1.25-6	7311518111359	10	20
3802-350-32-1.60-10	7311518111397	10	20
3802-350-32-1.60-14	7311518111403	10	20
3802-350-32-1.60-4	7311518111410	10	20
3802-350-32-1.60-6	7311518111427	10	20
3802-350-32-1.60-8	7311518140908	10	20
3802-400-25-1.25-10	7311518111496	10	20
3802-400-25-1.25-14	7311518111502	10	20
3802-400-25-1.25-6	7311518111519	10	20
3802-400-32-1.60-10	7311518111557	10	20
3802-400-32-1.60-14	7311518111564	10	20
3802-400-32-1.60-4	7311518111571	10	20
3802-400-32-1.60-6	7311518111588	10	20
3802-400-32-1.60-8	7311518111595	10	20
3802-400-38-2.00-10	7311518111649	10	20
3802-400-38-2.00-4	7311518111656	10	20
3802-400-38-2.00-6	7311518111663	10	20
3802-425-32-1.60-10	7311518111694	10	20
3802-425-32-1.60-6	7311518111700	10	20
3802-450-32-1.60-10	7311518111731	10	20
3802-450-32-1.60-14	7311518111748	10	20
3802-450-32-1.60-4	7311518111755	10	20
3802-450-32-1.60-6	7311518111762	10	20
3802-450-38-2.00-10	7311518111816	10	20
3802-450-38-2.00-10-KA	7311518111823	10	20
3802-450-38-2.00-4	7311518111830	10	20
3802-450-38-2.00-4-KA	7311518111847	10	20
3802-450-38-2.00-6	7311518111854	10	20
3802-450-38-2.00-6-KA	7311518111861	10	20
3802-450-38-2.00-8	7311518111878	10	20
3802-450-38-2.00-8-KA	7311518111885	10	20

3830-114-VIP



3830-114-VIP	7311518042073	4	130
3830-121-C	7311518225643	1	130
3830-121-VIP	7311518042080	1	130
3830-127-C	7311518225650	1	130
3830-127-VIP	7311518042097	1	130
3830-133-C	7311518228545	1	130
3830-133-VIP	7311518042103	1	130
3830-14-C	7311518228347	1	130
3830-14-VIP	7311518041618	6	130
3830-140-C	7311518228552	1	130
3830-140-VIP	7311518042110	1	130
3830-146-C	7311518228569	1	130
3830-146-VIP	7311518042127	1	130
3830-152-C	7311518225667	1	130
3830-152-VIP	7311518042134	1	130
3830-16-C	7311518225353	1	130
3830-16-VIP	7311518041625	6	130
3830-168	7311518040659	1	130
3830-17-C	7311518228354	1	130
3830-17-VIP	7311518041632	6	130
3830-177-HIGH	7311518101329	1	130
3830-19-4P	7314150428557	1	130
3830-19-C	7311518225360	1	130
3830-19-VIP	7311518041649	6	130
3830-20-4P	7314150428601	1	130
3830-20-C	7311518225377	1	130
3830-20-VIP	7311518041656	6	130
3830-21-C	7311518228361	1	130
3830-21-VIP	7311518041663	6	130
3830-210	7311518040666	1	130
3830-22-4P	7314150428649	1	130
3830-22-C	7311518225384	1	130
3830-22-VIP	7311518041670	6	130
3830-24-C	7311518228378	1	130
3830-24-VIP	7311518041687	6	130
3830-25-4P	7314150428663	1	130
3830-25-C	7311518225391	1	130
3830-25-VIP	7311518041694	6	130
3830-27-4P	7314150428670	1	130
3830-27-C	7311518225407	1	130
3830-27-VIP	7311518041700	6	130
3830-29-4P	7314150428922	1	130
3830-29-C	7311518225414	1	130
3830-29-VIP	7311518041717	6	130
3830-30-4P	7314150433483	1	130
3830-30-C	7311518225421	1	130
3830-30-VIP	7311518041724	6	130
3830-32-4P	7314150428687	1	130
3830-32-C	7311518225438	1	130
3830-32-VIP	7311518041731	6	130
3830-33-C	7311518228385	1	130
3830-33-VIP	7311518041748	6	130
3830-35-4P	7314150428700	1	130
3830-35-C	7311518225445	1	130
3830-35-VIP	7311518041755	6	130
3830-37-C	7311518228392	1	130
3830-37-VIP	7311518041762	6	130
3830-38-C	7311518225452	1	130
3830-38-VIP	7311518041779	6	130
3830-40-C	7311518228408	1	130
3830-40-VIP	7311518041786	6	130
3830-41-C	7311518225469	1	130
3830-41-VIP	7311518041793	6	130
3830-43-C	7311518228415	1	130
3830-43-VIP	7311518041809	6	130
3830-44-C	7311518225476	1	130
3830-44-VIP	7311518041816	6	130
3830-46-C	7311518228422	1	130
3830-46-VIP	7311518041823	6	130
3830-48-C	7311518225483	1	130
3830-48-VIP	7311518041830	6	130
3830-50-C	7311518260873	1	130
3830-50-VIP	7311518260866	6	130
3830-51-C	7311518225490	1	130
3830-51-VIP	7311518041847	6	130
3830-52-C	7311518228439	1	130
3830-52-VIP	7311518041854	4	130
3830-54-C	7311518225506	1	130
3830-54-VIP	7311518041861	4	130
3830-55-C	7311518270919	1	130
3830-55-VIP	7311518270902	4	130
3830-56-C	7311518228446	1	130
3830-56-VIP	7311518152703	4	130
3830-57-C	7311518225513	1	130
3830-57-VIP	7311518041878	4	130
3830-59-C	7311518228453	1	130
3830-59-VIP	7311518041885	4	130
3830-60-C	7311518225520	1	130
3830-60-VIP	7311518041892	4	130
3830-62-VIP	7311518234645	4	130
3830-64-C	7311518225537	1	130
3830-64-VIP	7311518041908	4	130
3830-65-C	7311518228460	1	130
3830-65-VIP	7311518041915	4	130
3830-67-C	7311518225544	1	130
3830-67-VIP	7311518041922	4	130



3830-68-C	7311518228477	1	130
3830-68-VIP	7311518196530	4	130
3830-70-C	7311518225551	1	130
3830-70-VIP	7311518041939	4	130
3830-73-C	7311518228484	1	130
3830-73-VIP	7311518041946	4	130
3830-76-C	7311518225568	1	130
3830-76-VIP	7311518041953	4	130
3830-79-C	7311518228491	1	130
3830-79-VIP	7311518041960	4	130
3830-83-C	7311518225575	1	130
3830-83-VIP	7311518041977	4	130
3830-86-C	7311518228507	1	130
3830-86-VIP	7311518041984	4	130
3830-89-C	7311518225582	1	130
3830-89-VIP	7311518041991	4	130
3830-92-C	7311518225599	1	130
3830-92-VIP	7311518042004	4	130
3830-95-C	7311518225605	1	130
3830-95-VIP	7311518042011	4	130
3830-98-C	7311518228514	1	130
3830-98-VIP	7311518042028	4	130
3832-102	7311518558567	4	137
3832-102-C	7314150474394	1	137
3832-105	7311518558581	4	137
3832-108	7311518558604	4	137
3832-111	7311518558611	4	137
3832-114	7311518558628	4	137
3832-114-C	7314150474424	1	137
3832-121	7311518558642	1	137
3832-127	7311518558666	1	137
3832-127-C	7314150474431	1	137
3832-133	7311518558673	1	137
3832-14	7311518557744	6	137
3832-140	7311518558680	1	137
3832-146	7311518558697	1	137
3832-152	7311518558703	1	137
3832-16	7311518557768	6	137
3832-16-C	7314150474448	1	137
3832-17	7311518557782	6	137
3832-19	7311518557805	6	137
3832-19-C	7314150474455	1	137
3832-20	7311518557812	6	137
3832-20-C	7314150474462	1	137
3832-21	7311518557829	6	137
3832-22	7311518557843	6	137
3832-22-C	7314150474479	1	137
3832-24	7311518557867	6	137
3832-24-C	7314150479054	1	137
3832-25	7311518557881	6	137
3832-25-C	7314150474486	1	137
3832-27	7311518557904	6	137
3832-29	7311518557928	6	137
3832-29-C	7314150474493	1	137
3832-30	7311518557942	6	137
3832-30-C	7314150479061	1	137
3832-32	7311518557966	6	137
3832-32-C	7314150474509	1	137
3832-33	7311518557980	6	137
3832-35	7311518558000	6	137
3832-35-C	7314150474516	1	137
3832-37	7311518558024	6	137
3832-38	7311518558048	6	137
3832-38-C	7314150474523	1	137
3832-40	7311518558062	6	137
3832-41	7311518558086	6	137
3832-41-C	7314150474530	1	137
3832-43	7311518558109	6	137
3832-44	7311518558123	6	137
3832-44-C	7314150474547	1	137
3832-46	7311518558147	6	137
3832-46-C	7314150479078	1	137
3832-48	7311518558161	6	137
3832-48-C	7314150474554	1	137
3832-51	7311518558185	6	137
3832-51-C	7314150474561	1	137
3832-52	7311518558208	4	137
3832-54	7311518558222	4	137
3832-54-C	7314150474578	1	137
3832-56	7311518558239	4	137
3832-57	7311518558246	4	137
3832-57-C	7314150474585	1	137
3832-59	7311518558260	4	137
3832-60	7311518558284	4	137
3832-60-C	7314150474615	1	137
3832-64	7311518558307	4	137
3832-64-C	7314150474622	1	137
3832-65	7311518558321	4	137
3832-67	7311518558345	4	137
3832-68	7311518558352	4	137
3832-70	7311518558369	4	137
3832-73	7311518558383	4	137
3832-73-C	7314150474639	1	137
3832-76	7311518558406	4	137
3832-76-C	7314150474646	1	137
3832-79	7311518558420	4	137



3832-83	7311518558444	4	137
3832-83-C	7314150474653	1	137
3832-86	7311518558468	4	137
3832-86-C	7314150474660	1	137
3832-89	7311518558482	4	137
3832-92	7311518558505	4	137
3832-92-C	7314150474677	1	137
3832-95	7311518558529	4	137
3832-98	7311518558543	4	137
3832-SET-164-ES	7314150487349	1	138
3832-SET-84-ES	7314150498932	1	138
3833-102-C	7314150263899	1	135
3833-105-C	7314150263905	1	135
3833-108-C	7314150263912	1	135
3833-109-C	7314150263929	1	135
3833-111-C	7314150263936	1	135
3833-114-C	7314150263943	1	135
3833-121-C	7314150263950	1	135
3833-127-C	7314150263967	1	135
3833-133-C	7314150401581	1	135
3833-140-C	7314150263974	1	135
3833-152-C	7314150263981	1	135
3833-159-C	7314150263998	1	135
3833-168	7314150413546	1	135
3833-177	7314150413539	1	135
3833-19-C	7314150263561	1	135
3833-20-C	7314150263578	1	135
3833-210	7314150413522	1	135
3833-22-C	7314150263585	1	135
3833-225	7314150413515	1	135
3833-25-C	7314150263592	1	135
3833-27-C	7314150263608	1	135
3833-29-C	7314150263615	1	135
3833-30-C	7314150263622	1	135
3833-32-C	7314150263639	1	135
3833-35-C	7314150263646	1	135
3833-38-C	7314150263653	1	135
3833-40-C	7314150263660	1	135
3833-41-C	7314150263677	1	135
3833-44-C	7314150263684	1	135
3833-48-C	7314150263691	1	135
3833-51-C	7314150263707	1	135
3833-54-C	7314150263714	1	135
3833-56-C	7314150314676	1	135
3833-57-C	7314150263721	1	135
3833-60-C	7314150263738	1	135
3833-62-C	7314150314683	1	135
3833-64-C	7314150263745	1	135
3833-65-C	7314150263752	1	135
3833-67-C	7314150263769	1	135
3833-68-C	7314150263776	1	135
3833-70-C	7314150263783	1	135
3833-71-C	7314150314690	1	135
3833-73-C	7314150263790	1	135
3833-74-C	7314150314706	1	135
3833-76-C	7314150263806	1	135
3833-77-C	7314150263813	1	135
3833-78-C	7314150314713	1	135
3833-79-C	7314150263820	1	135
3833-83-C	7314150263837	1	135
3833-86-C	7314150263844	1	135
3833-89-C	7314150263851	1	135
3833-92-C	7314150263868	1	135
3833-95-C	7314150263875	1	135
3833-98-C	7314150263882	1	135
3833-PROMO-42	7314150464951	1	135
3833-SET-101	7314150315383	1	135
3833-SET-201	7314150315406	1	135
3833-SET-202	7314150315420	1	135
3833-SET-203	7314150315444	1	136
3833-SET-204	7314150315468	1	136
3833-SET-205	7314150330874	1	136
3833-SET-207	7314150330898	1	136
3833-SET-208	7314150330904	1	136
3833-SET-301	7314150315376	1	136
3833-SET-302	7314150315390	1	137
3833-SET-303	7314150315413	1	137
3833-SET-304	7314150315437	1	137
3834-ADP	7311518454425	1	139
3834-ARBR-11152	7311518015596	1	139
3834-ARBR-11152-C	7311518225698	1	139
3834-ARBR-11152QC	7311518167967	1	139
3834-ARBR-11152QC-C	7311518225711	1	139
3834-ARBR-1130	7311518015572	4	139
3834-ARBR-1130-C	7311518228583	1	139
3834-ARBR-16152	7311518015602	1	139
3834-ARBR-16152QC	7311518453152	1	139
3834-ARBR-630	7311518015558	1	139
3834-ARBR-630-C	7311518228576	1	139
3834-ARBR-730	7311518167974	1	139
3834-ARBR-730-C	7311518225674	1	139
3834-ARBR-9100	7311518015589	1	139
3834-ARBR-9100-C	7311518228590	1	139
3834-ARBR-9100EL	7314150265077	1	138
3834-ARBR-9100ESM	7314150390458	1	138
3834-ARBR-9100QC	7311518249830	1	139

* Until stocks last



3834-ARBR-9100QC-C	7311518225704	1	139
3834-ARBR-930	7311518015565	1	139
3834-ARBR-930-C	7311518225681	1	139
3834-ARBR-930EL	7314150265053	1	138
3834-ARBR-930ESM	7314150390465	1	138
3834-ARBR-930QC-C	7314150472239	1	139
3834-ARBR-SD152QC	7311518203825	1	139
3834-ARBR-SD30	7311518203818	1	139
3834-CP-20/25	7314150312092	1	130
3834-DRL	7311518234638	1	139
3834-DRL-CT	7311518953201	1	139
3834-DRL-EL	7314150265114	1	138
3834-DRL-ES	7314150265091	1	138
3834-DRL-HSS-ES	7314150339396	1	138
3834-DRL-L	7314150265138	1	139
3834-ES	7311518454418	1	139
3834-EXT-1	7311518040673	1	139
3834-EXT-2	7311518168070	1	139
3834-M6X29-SET	7314150383450	1	140
3834-M8X10-SET	7314150383429	1	140
3834-M8X5-SET	7314150383443	1	140
3834-M8X6-SET	7314150383436	1	140
3834-PROMO-122	7314150432059	1	131
3834-PROMO-122-76	7314150459193	1	131
3834-PROMO-82	7314150432042	1	131
3834-SET-103	7314150134908	1	134
3834-SET-152	7314150255658	1	134
3834-SET-42	7311518241988	1	131
3834-SET-53	7314150127153	1	131
3834-SET-61	7311518266431	1	132
3834-SET-62	7311518228040	1	132
3834-SET-62-16/50	7311518258887	1	132
3834-SET-65-16/51	7311518159900	1	132
3834-SET-65-22/64	7311518159917	1	132
3834-SET-72	7311518044992	1	132
3834-SET-72-35/83	7314150444229	1	131
3834-SET-73	7311518254339	1	133
3834-SET-73-22/68	7314150134809	1	133
3834-SET-77	7314150235919	1	133
3834-SET-84-ES	7314150470587	1	133
3834-SET-86	7311518224295	1	133
3834-SET-87	7311518181772	1	133
3834-SET-92	7311518044985	1	134
3834-SET-93	7314150414741	1	134
3834-SET-94	7311518166458	1	134
3834-SET-95	7311518159894	1	134
3834-UPSIZ	7314150344567	1	139
3835-SET-64	7314150423309	1	138
3835-SET-711	7314150465835	1	138
384-5T	7311518159795	4	616
384-6T	7311518002039	4	616
3845-18-10P	7311518101602	1	141
3845-24-10P	7311518101619	1	141
3845-32-10P	7311518101626	1	141
385-6T	7311518002053	4	616
3851-10-0.6-10/14	7311518182717	1	12
3851-10-0.6-H-4	7311518282776	1	12
3851-10-0.6-H-6	7311518282806	1	12
3851-10-0.6-HA-4	7314150139309	1	12
3851-10-0.9-10/14	7311518182823	1	12
3851-10-0.9-H-4	7311518282851	1	12
3851-10-0.9-H-6	7311518282868	1	12
3851-10-0.9-R-14	7314150312399	1	12
3851-13-0.5-10/14	7311518282813	1	12
3851-13-0.5-14/18	7311518282790	1	12
3851-13-0.5-H-4	7311518292072	1	12
3851-13-0.5-R-10	7311518331306	1	12
3851-13-0.5-R-14	7311518331320	1	12
3851-13-0.5-R-18	7311518331344	1	12
3851-13-0.5-R-24	7311518282820	1	12
3851-13-0.6-10/14	7311518183271	1	12
3851-13-0.6-5/8	7311518183233	1	12
3851-13-0.6-6/10	7311518183240	1	12
3851-13-0.6-8/12	7311518185572	1	12
3851-13-0.6-H-3	7311518282769	1	12
3851-13-0.6-H-4	7311518282745	1	12
3851-13-0.6-H-6	7311518282738	1	12
3851-13-0.6-HA-4	7311518282752	1	12
3851-13-0.6-HA-6	7311518282561	1	12
3851-13-0.6-R-10	7311518183110	1	12
3851-13-0.6-R-14	7311518183158	1	12
3851-13-0.6-R-18	7311518183196	1	12
3851-13-0.9-10/14	7311518183868	1	12
3851-13-0.9-6/10	7311518183585	1	12
3851-13-0.9-H-3	7311518282936	1	12
3851-13-0.9-H-4	7311518282943	1	12
3851-13-0.9-H-6	7311518286125	1	12
3851-13-0.9-HA-4	7311518281052	1	12
3851-13-0.9-R-14	7311518182359	1	12
3851-13-0.9-R-6	7311518183301	1	12
3851-20-0.9-10/14	7311518282585	1	12
3851-20-0.9-4/6	7311518183905	1	12
3851-20-0.9-5/8	7311518183929	1	12
3851-20-0.9-6/10	7311518183936	1	12
3851-20-0.9-8/12	7311518282578	1	12
3851-20-0.9-H-3	7314150398515	1	12



3851-20-0.9-H-4



3851-20-0.9-H-4	7314150398294	1	12
3851-20-0.9-HA-3	7311518282646	1	12
3851-20-0.9-HA-4	7311518282653	1	12
3851-20-0.9-R-18	7311518332587	1	12
3851-27-0.9-10/14	7311518165475	1	13
3851-27-0.9-2/3	7311518126377	1	13
3851-27-0.9-3/4	7311518126384	1	13
3851-27-0.9-4/6	7311518126391	1	13
3851-27-0.9-5/8	7311518126407	1	13
3851-27-0.9-6/10	7311518126414	1	13
3851-27-0.9-8/12	7311518160692	1	13
3851-27-0.9-HA-3	7311518282684	1	12
3851-27-0.9-HA-4	7314150398317	1	12
3851-27-0.9-P-3	7311518157135	1	12
3851-27-0.9-P-4	7311518157661	1	12
3851-27-0.9-R-6	7311518126353	1	12
3851-34-1.1-2/3	7311518126476	1	13
3851-34-1.1-3/4	7311518126483	1	13
3851-34-1.1-4/6	7311518126490	1	13
3851-34-1.1-5/8	7311518126506	1	13
3851-34-1.1-6/10	7311518165505	1	13
3851-34-1.1-P-2	7311518157715	1	12
3851-34-1.1-P-3	7311518157753	1	12
3851-41-1.3-1.4/2	7311518211837	1	13
3851-41-1.3-2/3	7311518126568	1	13
3851-41-1.3-3/4	7311518126575	1	13
3851-41-1.3-4/6	7311518126582	1	13
3851-41-1.3-5/8	7311518262488	1	13
3851-54-1.3-1.4/2	7314150459360	1	13
3851-54-1.3-2/3	7311518163716	1	13
3851-54-1.3-3/4	7311518163723	1	13
3851-54-1.3-4/6	7311518168025	1	13
3851-54-1.6-1.4/2	7311518211431	1	13
3851-54-1.6-1/1.4	7311518188542	1	13
3851-54-1.6-2/3	7311518126636	1	13
3851-54-1.6-3/4	7311518126643	1	13
3851-54-1.6-4/6	7314150398539	1	13
3851-54-1.6-P-1.25	7311518158026	1	13
3851-6-0.6-10/14	7311518180652	1	12
3851-6-0.6-H-6	7311518282707	1	12
3851-6-0.9-10/14	7311518180768	1	12
3851-6-0.9-H-6	7311518282714	1	12
3851-67-1.6-7/1	7311518200909	1	13
3851-67-1.6-1.4/2	7314150273317	1	13
3851-67-1.6-1/1.4	7311518178840	1	13
3851-67-1.6-2/3	7311518335243	1	13
3851-67-1.6-3/4	7311518328597	1	13
3851-67-1.6-4/6	7311518194963	1	13
3851-80-1.6-7/1	7311518255367	1	13
3851-80-1.6-1.4/2	7311518255350	1	13
3851-80-1.6-1/1.4	7311518197377	1	13
3852-27-0.9-INS-3	7311518358204	1	18
3852-34-1.1-INS-3	7311518359188	1	18
3853-20-0.9-5/7-VS	7311518331689	1	14
3853-20-0.9-8/11-VS	7311518331702	1	14
3853-27-0.9-3/4	7311518285395	1	14
3853-27-0.9-4/6	7311518183998	1	14
3853-27-0.9-5/7-VS	7311518331115	1	14
3853-27-0.9-5/8	7311518202118	1	14
3853-27-0.9-8/11-VS	7311518331122	1	14
3853-34-1.1-2/3	7311518282875	1	14
3853-34-1.1-3/4	7311518184094	1	14
3853-34-1.1-4/6	7311518184087	1	14
3853-34-1.1-5/7-VS	7311518331726	1	14
3853-34-1.1-5/8	7311518202149	1	14
3853-34-1.1-8/11-VS	7311518331719	1	14
3853-41-1.3-2/3	7311518282882	1	14
3853-41-1.3-2/3-W	7314150370115	1	14
3853-41-1.3-2/3-WS	7314150415113	1	14
3853-41-1.3-3/4	7311518185770	1	14
3853-41-1.3-3/4-W	7311518338053	1	14
3853-41-1.3-3/4-WS	7314150415120	1	14
3853-41-1.3-4/6	7311518184100	1	14
3853-41-1.3-5/7-VS	7311518331733	1	14
3853-41-1.3-5/8	7311518202286	1	14
3853-54-1.3-3/4	7311518184124	1	14
3853-54-1.3-3/4-W	7314150352876	1	14
3853-54-1.3-5/8	7311518197568	1	14
3853-54-1.6-2/3	7311518282899	1	14
3853-54-1.6-2/3-W	7311518338077	1	14
3853-54-1.6-2/3-WS	7314150415151	1	14
3853-54-1.6-3/4	7311518216757	1	14
3853-54-1.6-3/4-W	7311518338091	1	14
3853-54-1.6-3/4-WS	7314150415168	1	14
3853-54-1.6-4/6	7311518222055	1	14
3853-67-1.6-2/3	7311518282905	1	14
3853-67-1.6-2/3-W	7311518338114	1	14
3853-67-1.6-2/3-WS	7314150415175	1	14
3853-67-1.6-3/4	7311518282912	1	14
3853-67-1.6-3/4-W	7311518338138	1	14
3853-67-1.6-3/4-WS	7314150415182	1	14
3853-67-1.6-5/8-W	7311518338152	1	14
3854-27-0.9-PHX-2/3	7314150440603	1	13
3854-27-0.9-PHX-3/4	7314150440610	1	13
3854-27-0.9-PHX-4/6	7314150440627	1	13
3854-27-0.9-PQ-3/4	7314150137480	1	13



3854-27-0.9-PQ-4/6	7314150197828	1	13
3854-34-1.1-PHX-1.4/2	7314150440634	1	13
3854-34-1.1-PHX-2/3	7314150440641	1	13
3854-34-1.1-PHX-3/4	7314150440658	1	13
3854-34-1.1-PHX-4/6	7314150440665	1	13
3854-34-1.1-PQ-2/3	7311518287276	1	13
3854-34-1.1-PQ-3/4	7314150135813	1	13
3854-34-1.1-PQ-4/6	7314150197835	1	13
3854-41-1.3-PHX-1.4/2	7314150440672	1	13
3854-41-1.3-PHX-2/3	7314150440689	1	13
3854-41-1.3-PHX-3/4	7314150440696	1	13
3854-41-1.3-PHX-4/6	7314150440702	1	13
3854-41-1.3-PQ-1.4/2	7314150129355	1	13
3854-41-1.3-PQ-2/3	7311518280604	1	13
3854-41-1.3-PQ-3/4	7311518282950	1	13
3854-41-1.3-PQ-4/6	7314150197842	1	13
3854-54-1.3-PHX-1.4/2	7314150440719	1	13
3854-54-1.3-PHX-2/3	7314150440733	1	13
3854-54-1.3-PHX-3/4	7314150440740	1	13
3854-54-1.6-PHX-7/1	7314150440757	1	13
3854-54-1.6-PHX-1.4/2	7314150440771	1	13
3854-54-1.6-PHX-1/1.4	7314150440764	1	13
3854-54-1.6-PHX-2/3	7314150440788	1	13
3854-54-1.6-PHX-3/4	7314150440795	1	13
3854-54-1.6-PQ-9/1.2	7314150133857	1	13
3854-54-1.6-PQ-1.4/2	7314150127092	1	13
3854-54-1.6-PQ-2/3	7311518265137	1	13
3854-54-1.6-PQ-3/4	7311518282929	1	13
3854-54-1.6-PQ-4/6	7311518330637	1	13
3854-67-1.6-PHX-7/1	7314150440801	1	13
3854-67-1.6-PHX-1.4/2	7314150440825	1	13
3854-67-1.6-PHX-1/1.4	7314150440818	1	13
3854-67-1.6-PHX-2/3	7314150440832	1	13
3854-67-1.6-PQ-9/1.2	7314150133888	1	13
3854-67-1.6-PQ-1.4/2	7314150133901	1	13
3854-67-1.6-PQ-2/3	7311518290160	1	13
3854-80-1.6-PHX-7/1	7314150440849	1	13
3854-80-1.6-PHX-1.4/2	7314150440863	1	13
3854-80-1.6-PHX-1/1.4	7314150440856	1	13
3854-80-1.6-PQ-9/1.2	7314150133895	1	13
3854-80-1.6-PQ-1.4/2	7314150215966	1	13
3857-13-0.6-EZ-L	7311518264789	1	12
3857-13-0.6-EZ-M	7311518264772	1	12
3857-13-0.6-EZ-M-3P1140	7314150321100	1	149
3857-13-0.6-EZ-M-3P690	7314150325641	1	149
3857-13-0.6-EZ-M-3P730	7314150325658	1	149
3857-13-0.6-EZ-M-3P835	7314150325665	1	149
3857-13-0.6-EZ-M-3P900	7314150321094	1	149
3857-13-0.6-EZ-S	7311518264765	1	12
3857-13-0.6-EZ-S-3P1140	7314150345731	1	149
3857-13-0.6-EZ-S-3P690	7314150345694	1	149
3857-13-0.6-EZ-S-3P730	7314150345700	1	149
3857-13-0.6-EZ-S-3P835	7314150345717	1	149
3857-13-0.6-EZ-S-3P900	7314150345724	1	149
3857-20-0.9-EZ-L	7311518264819	1	12
3857-20-0.9-EZ-M	7311518264802	1	12
3857-20-0.9-EZ-S	7311518264796	1	12
3857-27-0.9-EZ-L	7311518264840	1	12
3857-27-0.9-EZ-M	7311518264833	1	12
3857-27-0.9-EZ-S	7311518264826	1	12
3857-34-1.1-EZ-L	7311518264871	1	12
3857-34-1.1-EZ-M	7311518264864	1	12
3857-34-1.1-EZ-S	7311518264857	1	12
3858-34-1.1-PHX-1.4/2	7314150441198	1	14
3858-34-1.1-PHX-2/3	7314150441204	1	14
3858-34-1.1-PHX-3/4	7314150441211	1	14
3858-41-1.3-PHX-1.4/2	7314150441013	1	14
3858-41-1.3-PHX-2/3	7314150441020	1	14
3858-41-1.3-PHX-3/4	7314150441037	1	14
3858-41-1.3-PQ-1.4/2	7314150395583	1	14
3858-41-1.3-PQ-2/3	7314150395590	1	14
3858-41-1.3-PQ-3/4	7314150395606	1	14
3858-54-1.3-PHX-1.4/2	7314150441068	1	14
3858-54-1.3-PHX-2/3	7314150441044	1	14
3858-54-1.3-PHX-3/4	7314150441051	1	14
3858-54-1.6-PHX-7/1	7314150441075	1	14
3858-54-1.6-PHX-1.4/2	7314150441099	1	14
3858-54-1.6-PHX-1/1.4	7314150441082	1	14
3858-54-1.6-PHX-2/3	7314150441105	1	14
3858-54-1.6-PHX-3/4	7314150441112	1	14
3858-54-1.6-PQ-9/1.2	7314150395613	1	14
3858-54-1.6-PQ-1.4/2	7314150395620	1	14
3858-54-1.6-PQ-2/3	7314150395637	1	14
3858-67-1.6-PHX-7/1	7314150441129	1	14
3858-67-1.6-PHX-1.4/2	7314150441143	1	14
3858-67-1.6-PHX-1/1.4	7314150441136	1	14
3858-67-1.6-PHX-2/3	7314150441150	1	14
3858-67-1.6-PQ-9/1.2	7314150395644	1	14
3858-67-1.6-PQ-1.4/2	7314150395651	1	14
3858-80-1.6-PHX-7/1	7314150441167	1	14
3858-80-1.6-PHX-1.4/2	7314150441181	1	14
3858-80-1.6-PHX-1/1.4	7314150441174	1	14
3858-80-1.6-PQ-9/1.2	7314150395668	1	14
3859-27-0.9-EZX-3/4	7314150517558	1	15
3859-27-0.9-EZX-4/6	7314150517565	1	15
3859-34-1.1-EZX-2/3	7314150517572	1	15



3859-34-1.1-EZX-3/4	7314150517589	1	15
3859-34-1.1-EZX-4/6	7314150517596	1	15
3859-41-1.3-EZX-1.4/2	7314150517602	1	15
3859-41-1.3-EZX-2/3	7314150517619	1	15
3859-41-1.3-EZX-3/4	7314150517626	1	15
3859-41-1.3-EZX-4/6	7314150517633	1	15
3859-54-1.6-EZX-1.4/2	7314150517640	1	15
3859-54-1.6-EZX-1/1.25	7314150517657	1	15
3859-54-1.6-EZX-2/3	7314150517664	1	15
3859-54-1.6-EZX-3/4	7314150517671	1	15
3859-54-1.6-EZX-4/6	7314150517688	1	15
3859-67-1.6-EZX-7/1	7314150517695	1	15
3859-67-1.6-EZX-1.4/2	7314150517701	1	15
3859-67-1.6-EZX-1/1.25	7314150517718	1	15
3859-67-1.6-EZX-2/3	7314150517725	1	15
3859-80-1.6-EZX-7/1	7314150517732	1	15
3859-80-1.6-EZX-1.4/2	7314150517749	1	15
3859-80-1.6-EZX-1/1.25	7314150517756	1	15
386-6T	7311518152017	4	616
3860-100-1.1-TMC-1.4/2	7314150336968	1	16
3860-27-0.9-TCA-3	7311518330750	1	17
3860-27-0.9-TCD-3	7314150413010	1	16
3860-27-0.9-TCD-3/4	7314150413027	1	16
3860-27-0.9-TCD-3/4	7314150263493	1	17
3860-34-1.1-TCA-2/3	7311518330781	1	17
3860-34-1.1-TCA-3	7311518330774	1	17
3860-34-1.1-TCD-2/3	7314150413034	1	16
3860-34-1.1-TCD-3/4	7314150413041	1	16
3860-34-1.1-TCD-3/4-W	7314150413058	1	16
3860-34-1.1-TCZ-2/3	7311518330880	1	17
3860-34-1.1-TCZ-3/4	7311518330897	1	17
3860-41-1.3-TCA-1.4/2	7311518330620	1	17
3860-41-1.3-TCA-2/3	7311518330675	1	17
3860-41-1.3-TCD-1.4/2	7314150413065	1	16
3860-41-1.3-TCD-1.9/2.1	7314150413072	1	16
3860-41-1.3-TCD-2/3	7314150413089	1	16
3860-41-1.3-TCD-3/4	7314150413096	1	16
3860-41-1.3-TCZ-2/3	7311518330903	1	17
3860-41-1.3-TCZ-3/4	7311518330910	1	17
3860-41-1.3-TMC-1.4/2	7314150129379	1	16
3860-41-1.3-TMC-2/3	7311518330224	1	16
3860-54-1.3-TMC-1.4/2	7314150288748	1	16
3860-54-1.3-TMC-2/3	7311518335267	1	16
3860-54-1.6-TCA-8/1	7314150502998	1	17
3860-54-1.6-TCA-1.4/2	7311518330798	1	17
3860-54-1.6-TCA-1/1.25	7311518330934	1	17
3860-54-1.6-TCD-1.4/2	7314150413119	1	16
3860-54-1.6-TCD-1.9/2.1	7314150413133	1	16
3860-54-1.6-TCD-2/3	7314150413140	1	16
3860-54-1.6-TCD-3/4	7314150413157	1	16
3860-54-1.6-TMC-7/1	7314150263431	1	16
3860-54-1.6-TMC-1.4/2	7314150137978	1	16
3860-54-1.6-TMC-1.4/2S	7314150395316	1	17
3860-54-1.6-TMC-1/1.25	7314150154340	1	16
3860-54-1.6-TMC-1/1.25S	7314150395309	1	17
3860-54-1.6-TMC-2/3	7314150189366	1	16
3860-54-1.6-TMC-2/3S	7314150395323	1	17
3860-67-1.6-TCD-1.4/2	7314150413164	1	16
3860-67-1.6-TCD-1/1.25	7314150413171	1	16
3860-67-1.6-TMC-1.4/2	7314150137985	1	16
3860-67-1.6-TMC-1.4/2S	7314150395347	1	17
3860-67-1.6-TMC-1/1.25	7314150154364	1	16
3860-67-1.6-TMC-1/1.25S	7314150395330	1	17
3860-67-1.6-TMC-2/3	7314150189359	1	16
3860-80-1.1-TMC-1.4/2	7314150382767	1	16
3860-80-1.6-TCA-8/1	7314150353651	1	17
3860-80-1.6-TCD-5/0.8	7314150413188	1	16
3860-80-1.6-TMC-7/1	7314150154371	1	16
3860-80-1.6-TMC-1.4/2	7314150182992	1	16
3860-80-1.6-TMC-1/1.25	7314150182336	1	16
3860-80-1.6-TMC-2/3	7314150215959	1	16
3861-20-0.6-H-4	7311518331351	1	17
3861-27-0.9-H-1.33	7311518329716	1	17
3861-34-0.9-H-1.15	7311518258894	1	17
3861-34-1.1-H-1.15	7311518258900	1	17
3861-41-1.1-H-1.15	7314150129294	1	17
3861-54-1.1-H-1.15	7314150129270	1	17
3862-33-0.9-H-1.15	7314150320325	1	18
3862-33-1.1-H-1.15	7311518331269	1	18
3862-40-1.1-H-1.15	7311518331283	1	18
3868-27-0.9-TSS-3/4	7314150447633	1	15
3868-27-0.9-TSX-3/4	7311518329693	1	15
3868-34-1.1-TSS-2/3	7311518329266	1	15
3868-34-1.1-TSS-3/4	7314150447640	1	15
3868-34-1.1-TSX-2	7311518203016	1	15
3868-34-1.1-TSX-2/3	7311518255343	1	15
3868-34-1.1-TSX-3/4	7311518232375	1	15
3868-41-1.3-TSS-1.4/2	7311518243142	1	15
3868-41-1.3-TSS-2/3	7311518270643	1	15
3868-41-1.3-TSX-1.4/2	7311518214210	1	15
3868-41-1.3-TSX-1.6	7311518203092	1	15
3868-41-1.3-TSX-2	7311518203085	1	15
3868-41-1.3-TSX-2/3	7311518232382	1	15
3868-41-1.3-TSX-3/4	7311518232399	1	15
3868-54-1.3-TSX-1.4/2	7311518214876	1	15
3868-54-1.3-TSX-2/3	7314150416394	1	15

* Until stocks last



3868-54-1.6-TSS-1.4/2	7311518243166	1	15
3868-54-1.6-TSS-1/1.25	7311518243173	1	15
3868-54-1.6-TSS-2/3	7311518280383	1	15
3868-54-1.6-TSX-1.4/2	7311518214869	1	15
3868-54-1.6-TSX-1.6	7311518203108	1	15
3868-54-1.6-TSX-1/1.25	7311518213114	1	15
3868-54-1.6-TSX-2/3	7311518232405	1	15
3868-54-1.6-TSX-3/4	7311518270360	1	15
3868-67-1.6-TSS-7/1	7311518274115	1	15
3868-67-1.6-TSS-1.4/2	7311518243197	1	15
3868-67-1.6-TSS-1/1.25	7311518243180	1	15
3868-67-1.6-TSS-2/3	7311518328825	1	15
3868-67-1.6-TSX-7/1	7311518212865	1	15
3868-67-1.6-TSX-1.4/2	7311518265496	1	15
3868-67-1.6-TSX-1/1.25	7311518213084	1	15
3868-67-1.6-TSX-2/3	7314150203536	1	15
3868-80-1.1-TSX-3/4	7311518330200	1	15
3868-80-1.6-TSS-7/1	7314150216253	1	15
3868-80-1.6-TSS-1.4/2	7314150203529	1	15
3868-80-1.6-TSS-2/3	7314150398553	1	15
3868-80-1.6-TSX-7/1	7311518212872	1	15
3868-80-1.6-TSX-1.4/2	7314150342167	1	15
3868-80-1.6-TSX-1/1.25	7314150277278	1	15
3868-80-1.6-TSX-2/3	7314150203543	1	15
3869-13-0.9-TS-3	7311518200589	1	15
3869-20-0.9-TS-3	7311518177300	1	15
3869-20-0.9-TS-4	7311518197742	1	15
3869-27-0.9-TS-3	7311518177348	1	15
3869-27-0.9-TS-4	7311518182595	1	15
3869-34-1.1-TS-2	7314150330508	1	15
3869-34-1.1-TS-3	7311518177355	1	15
3870-BRUSH-100-10	7311518269876	4	21
3870-BRUSH-100-10-HEX	7311518333935	4	21
3870-BRUSH-100-12	7311518269883	4	21
3870-BRUSH-100-13	7314150321131	1	21
3870-BRUSH-60-6	7311518279523	4	21
3870-BRUSH-80-10	7311518278311	4	21
3870-BRUSH-80-6	7311518269906	4	21
3870-BRUSH-80-8	7311518269890	4	21
3870-REFRACTOMETER	7311518192129	1	21
3870-TENSION METER	7311518145637	1	21
3870-WEDGE-3	7311518262747	1	21
3870-WHEEL	7314150398652	1	21
3875-BP2	7314150187744	10	460
3875-HB10*	7314150349777	1	459
3875-HB100	7314150289783	1	459
3875-HB30	7314150187720	1	459
3875-HB60	7314150187713	6	459
3875-LY10*	7314150315062	1	459
3875-LY2	7314150191260	8	458
3875-LY3	7314150191284	8	458
3875-LY600	7314150551521	1	458
3875-LY70	7314150442751	1	458
3875-LY8*	7314150309689	1	458
3875-MHP6	7314150187812	1	460
3875-QL1	7314150191307	8	458
3875-QRL1	7314150194797	1	458
3875-RL1	7314150194780	1	458
3875-RL2	7314150312948	1	458
3875-SB70	7314150326839	1	460
3875-SL1	7314150220106	1	459
3875-WL1	7314150191291	8	458
3881-100-1.6-THS-7/1	7311518329617	1	16
3881-34-1.1-THQ-2/3	7311518265793	1	16
3881-41-1.3-THQ-1.4/2	7314150129447	1	16
3881-41-1.3-THQ-2/3	7314150129454	1	16
3881-41-1.3-THS-1.4/2	7311518273712	1	16
3881-54-1.6-THQ-1.4/2	7314150128860	1	16
3881-54-1.6-THQ-1/1.25	7314150342181	1	16
3881-54-1.6-THQ-2/3	7314150138739	1	16
3881-54-1.6-THS-1.4/2	7314150138784	1	16
3881-54-1.6-THS-1/1.25	7311518269050	1	16
3881-67-1.6-THQ-1.4/2	7314150120369	1	16
3881-67-1.6-THQ-1/1.25	7314150180097	1	16
3881-67-1.6-THQ-2/3	7311518328832	1	16
3881-67-1.6-THS-1.4/2	7314150138791	1	16
3881-67-1.6-THS-1/1.25	7311518269043	1	16
3881-67-1.6-THS-2/3	7311518328849	1	16
3881-80-1.6-THQ-7/1	7311518332938	1	16
3881-80-1.6-THQ-1.4/2	7311518328856	1	16
3881-80-1.6-THQ-1/1.25	7314150133918	1	16
3881-80-1.6-THQ-2/3	7311518328863	1	16
3881-80-1.6-THS-7/1	7311518279202	1	16
3881-80-1.6-THS-1.4/2	7314150195312	1	16
3881-80-1.6-THS-2/3	7314150215942	1	16
38A-08	7314150433469	25	326
38A-10	7314150431564	25	326
38A-12	7314150237944	1	326
38A-15	7314150237951	25	326
38A-21	7314150237968	1	326
38A-26	7314150237975	1	326
38C-26	7314150237982	1	326
39-24	7314151831301	1	326
3905-250-24-100	7311518299255	100	546
3905-300-14-100	7311518292201	100	546
3905-300-18-100	7311518292218	100	546





3905-300-24-100	7311518292225	100	546
3905-300-24-2P	7311518299248	10	546
3905-300-32-100	7311518292232	100	546
3906-250-18-100	7311518250997	100	545
3906-250-18-5P	7314150265534	10	545
3906-250-24-100	7311518251000	100	545
3906-250-24-5P	7314150265541	10	545
3906-250-32-100	7311518251017	100	545
3906-250-32-5P	7314150265558	10	545
3906-300-14-100	7311518233563	100	545
3906-300-14-10P	7311518233693	10	545
3906-300-14-5P	7314150265565	10	545
3906-300-18-100	7311518233570	100	545
3906-300-18-10P	7311518233723	10	545
3906-300-18-2P	7311518233617	10	545
3906-300-18-5P	7314150265572	10	545
3906-300-24-100	7311518233587	100	545
3906-300-24-10P	7311518233730	10	545
3906-300-24-2P	7311518233624	10	545
3906-300-24-5P	7311518237417	10	545
3906-300-32-100	7311518233594	100	545
3906-300-32-10P	7311518233747	10	545
3906-300-32-2P	7311518233631	10	545
3906-300-32-5P	7311518237424	10	545
3906-300-3P	7311518233754	10	545
3911-115-T41-AL	7314150485642	25	148
3911-115-T41-I	7314150454570	25	148
3911-115-T41-IM	7314150454587	50	148
3911-115-T42-M	7314150454679	25	148
3911-115T41-IM	7314150460599	25	148
3911-125-T41-AL	7314150485666	25	148
3911-125-T41-I	7314150454594	25	148
3911-125-T41-IM	7314150454600	50	148
3911-125-T42-M	7314150454686	25	148
3911-125T41-IM	7314150485444	25	148
3911-150-T41-I	7314150454624	50	148
3911-150-T42-M	7314150454709	25	148
3911-180-T41-I	7314150454631	50	148
3911-180-T41-IM	7314150454655	50	148
3911-180-T42-M	7314150454693	25	148
3911-180T41-IM	7314150485468	50	148
3911-230-T41-I	7314150454648	50	148
3911-230-T41-IM	7314150454662	50	148
3911-230-T42-M	7314150454716	50	148
3911-2301922XDT	7314150522439	50	148
3911-230T1T41-IM	7314150485482	50	148
3911-2302522XDT	7314150522415	50	148
3911-2303T41-IM	7314150485628	50	148
3911-350-X2TM	7314150486366	35	148
3911-400-F2TM	7314150485963	15	148
3911-400-X2TM	7314150502967	15	148
3911-751010XTM	7314150522392	10	148
3912-115-T41-IM	7314150454808	25	148
3912-115-T42-ST	7314150454723	25	148
3912-125-T41-IM	7314150454815	25	148
3912-125-T42-ST	7314150454730	25	148
3912-180-T42-ST	7314150454747	25	148
3912-230-T42-ST	7314150454754	50	148
3916-115-10P-CE	7314150455348	100	149
3916-115-10S-UE	7314150455270	100	149
3916-125-10P-CE	7314150455355	100	149
3916-125-10S-UE	7314150455287	100	149
3916-150-10S-UE	7314150455294	50	149
3916-180-10S-UE	7314150455300	50	149
3916-230-10L-RC	7314150455232	25	149
3916-230-10S-UE	7314150455317	25	149
3917-115-7S-C	7314150455324	100	149
3917-115-7S-U	7314150455249	100	149
3917-125-7S-C	7314150455331	100	149
3917-125-7S-U	7314150455256	100	149
3917-230-7S-U	7314150455263	25	149
3921-115-T27-IM	7314150454617	25	148
3921-125-T27-IM	7314150454761	25	148
3921-150-T27-IM	7314150454778	25	148
3921-180-T27-IM	7314150454785	25	148
3921-230-T27-IM	7314150454792	25	148
3926-115IM-C120	7314150454860	20	148
3926-115IM-C40	7314150454839	20	148
3926-115IM-C60	7314150454846	20	148
3926-115IM-C80	7314150454853	20	148
3926-125IM-C120	7314150454914	20	148
3926-125IM-C40	7314150454884	20	148
3926-125IM-C60	7314150454891	20	148
3926-125IM-C80	7314150454907	20	148
3927-115IM-P120	7314150454952	20	149
3927-115IM-P40	7314150454921	20	149
3927-115IM-P60	7314150454938	20	149
3927-115IM-P80	7314150454945	20	149
3927-125-120-3P	7314150499007	12	149
3927-125-40-3P	7314150498949	12	149
3927-125-60-3P	7314150498963	12	149
3927-125-80-3P	7314150498987	12	149
3927-125IM-P120	7314150455010	20	149
3927-125IM-P40	7314150454976	20	149
3927-125IM-P60	7314150454983	20	149
3927-125IM-P80	7314150455003	20	149



3940-100-14-SC-2P	7314150364466	10	140
3940-100-14-SC-5P	7314150364473	5	140
3940-100-14-ST-10P	7314150364336	1	140
3940-100-14-ST-2P	7314150364312	10	140
3940-100-14-ST-5P	7314150364329	5	140
3940-100-18-SC-2P	7314150364442	10	140
3940-100-18-SC-5P	7314150364459	5	140
3940-100-18-ST-10P	7314150364367	1	140
3940-100-18-ST-2P	7314150364343	10	140
3940-100-18-ST-5P	7314150364350	5	140
3940-100-24-SC-2P	7314150364558	10	140
3940-100-24-SC-5P	7314150364565	5	140
3940-100-24-ST-10P	7314150364435	1	140
3940-100-24-ST-2P	7314150364411	10	140
3940-100-24-ST-5P	7314150364428	5	140
3940-150-10-HST-10P	7314150364039	1	140
3940-150-10-HST-2P	7314150364015	10	140
3940-150-10-HST-5P	7314150364022	5	140
3940-150-10-ST-100P	7314150362196	1	140
3940-150-10-ST-10P	7314150362189	1	140
3940-150-10-ST-2P	7314150362165	5	140
3940-150-10-ST-5P	7314150362172	5	140
3940-150-14-HST-10P	7314150362370	1	140
3940-150-14-HST-2P	7314150362325	10	140
3940-150-14-HST-5P	7314150362363	5	140
3940-150-14-ST-100P	7314150364183	1	140
3940-150-14-ST-10P	7314150364176	1	140
3940-150-14-ST-2P	7314150364152	10	140
3940-150-14-ST-5P	7314150364169	5	140
3940-150-18-HST-10P	7314150364060	1	140
3940-150-18-HST-2P	7314150364046	10	140
3940-150-18-HST-5P	7314150364053	5	140
3940-150-18-ST-100P	7314150364107	1	140
3940-150-18-ST-10P	7314150364091	1	140
3940-150-18-ST-2P	7314150364077	10	140
3940-150-18-ST-5P	7314150364084	5	140
3940-150-24-ST-100P	7314150364404	1	140
3940-150-24-ST-10P	7314150364398	1	140
3940-150-24-ST-2P	7314150364374	5	140
3940-150-24-ST-5P	7314150364381	5	140
3940-150-4/6-SC-10P	7314150361847	1	141
3940-150-4/6-SC-2P	7314150361823	10	141
3940-150-4/6-SC-5P	7314150361830	5	141
3940-150-5/8-DSL-10P	7314150361991	1	141
3940-150-5/8-DSL-2P	7314150361977	5	141
3940-150-5/8-DSL-5P	7314150361984	5	141
3940-150-5/8-SL-100P	7314150361724	1	141
3940-150-5/8-SL-10P	7314150361717	1	141
3940-150-5/8-SL-2P	7314150361687	10	141
3940-150-5/8-SL-5P	7314150361700	5	141
3940-150-6-ST-10P	7314150361786	1	141
3940-150-6-ST-2P	7314150361762	10	141
3940-150-6-ST-5P	7314150361779	5	141
3940-150-8/12-ST-100P	7314150362158	1	140
3940-150-8/12-ST-10P	7314150362141	1	140
3940-150-8/12-ST-2P	7314150362127	10	140
3940-150-8/12-ST-5P	7314150362134	5	140
3940-228-10-DSL-100P	7314150362035	1	141
3940-228-10-DSL-10P	7314150362028	1	141
3940-228-10-DSL-2P	7314150362004	10	141
3940-228-10-DSL-5P	7314150362011	5	141
3940-228-10-HST-100P	7314150362417	1	140
3940-228-10-HST-10P	7314150362400	1	140
3940-228-10-HST-2P	7314150362387	10	140
3940-228-10-HST-5P	7314150362394	5	140
3940-228-10-PR09-100P	7314150361625	1	141
3940-228-10-ST-100P	7314150362110	1	140
3940-228-10-ST-10P	7314150362103	1	140
3940-228-10-ST-2P	7314150362080	10	140
3940-228-10-ST-5P	7314150362097	5	140
3940-228-10/14-PR09-100P	7314150361526	1	141
3940-228-10/14-PR09-10P	7314150361519	1	141
3940-228-10/14-PR13-100P	7314150361649	1	141
3940-228-10/14-PR13-10P	7314150451265	1	141
3940-228-14-HST-10P	7314150362226	1	140
3940-228-14-HST-2P	7314150362202	10	140
3940-228-14-HST-5P	7314150362219	5	140
3940-228-14-ST-100P	7314150364145	1	140
3940-228-14-ST-10P	7314150364138	1	140
3940-228-14-ST-2P	7314150364114	10	140
3940-228-14-ST-5P	7314150364121	5	140
3940-228-18-HST-10P	7314150362271	1	140
3940-228-18-HST-2P	7314150362233	10	140
3940-228-18-HST-5P	7314150362264	5	140
3940-228-18-ST-100P	7314150364220	1	140
3940-228-18-ST-10P	7314150364213	1	140
3940-228-18-ST-2P	7314150364190	10	140
3940-228-18-ST-5P	7314150364206	5	140
3940-228-5/8-DSL-10P	7314150361939	1	141
3940-228-5/8-DSL-2P	7314150361915	10	141
3940-228-5/8-DSL-5P	7314150361922	5	141
3940-228-6-SL-10P	7314150361755	1	141
3940-228-6-SL-2P	7314150361731	10	141
3940-228-6-SL-5P	7314150361748	5	141
3940-228-8/12-PR13-100P	7314150361601	1	141
3940-228-8/12-ST-100P	7314150362073	1	140

3940-228-8/12-ST-10P	7314150362066	1	140
3940-228-8/12-ST-2P	7314150362042	5	140
3940-228-8/12-ST-5P	7314150362059	5	140
3940-300-10-HST-10P	7314150362448	1	140
3940-300-10-HST-2P	7314150362424	10	140
3940-300-10-HST-5P	7314150362431	5	140
3940-300-14-HST-10P	7314150362301	1	140
3940-300-14-HST-2P	7314150362288	10	140
3940-300-14-HST-5P	7314150362295	5	140
3940-300-14-ST-100P	7314150364268	1	140
3940-300-14-ST-10P	7314150364251	1	140
3940-300-14-ST-2P	7314150364237	10	140
3940-300-14-ST-5P	7314150364244	5	140
3940-300-18-HST-10P	7314150364008	1	140
3940-300-18-HST-2P	7314150363988	10	140
3940-300-18-HST-5P	7314150363995	5	140
3940-300-18-ST-100P	7314150364305	1	140
3940-300-18-ST-10P	7314150364299	1	140
3940-300-18-ST-2P	7314150364275	10	140
3940-300-18-ST-5P	7314150364282	5	140
3940-300-5/8-DSL-10P	7314150361960	1	141
3940-300-5/8-DSL-2P	7314150361946	10	141
3940-300-5/8-DSL-5P	7314150361953	5	141
3940-300-6-SL-10P	7314150361816	1	141
3940-300-6-SL-2P	7314150361793	10	141
3940-300-6-SL-5P	7314150361809	5	141
3940-300-8/12-SL-100P	7314150361908	1	141
3940-300-8/12-SL-10P	7314150361892	1	141
3940-300-8/12-SL-2P	7314150361878	5	141
3940-300-8/12-SL-5P	7314150361885	5	141
3940-HDD-SET-5P	7314150401703	5	143
3940-METAL-SET-12P	7314150511488	6	143
3940-METAL-SET-5P	7314150401673	5	142
3940-MIX-SET-10P	7314150401666	4	143
3940-MIX-SET-12P	7314150511501	6	143
3940-MIX-SET-5P	7314150401659	5	143
3942-150-7-SL-10P	7314150364534	1	142
3942-150-7-SL-2P	7314150364510	10	142
3942-150-7-SL-5P	7314150364527	5	142
3942-228-11-HSL-10P	7314150364831	1	142
3942-228-11-HSL-2P	7314150364817	10	142
3942-228-11-HSL-5P	7314150364824	5	142
3942-228-5-HSL-10P	7314150364657	1	142
3942-228-5-HSL-2P	7314150364633	10	142
3942-228-5-HSL-5P	7314150364640	5	142
3942-228-7-HSL-10P	7314150364749	1	141
3942-228-7-HSL-2P	7314150364725	10	141
3942-228-7-HSL-5P	7314150364732	5	141
3942-228-7-SL-10P	7314150364503	1	142
3942-228-7-SL-2P	7314150364480	10	142
3942-228-7-SL-5P	7314150364497	5	142
3942-300-5-HSL-10P	7314150364688	1	142
3942-300-5-HSL-2P	7314150364664	10	142
3942-300-5-HSL-5P	7314150364671	5	142
3942-300-7-HSL-10P	7314150364770	1	141
3942-300-7-HSL-2P	7314150364756	10	141
3942-300-7-HSL-5P	7314150364763	5	141
3942-300-7-SL-10P	7314150364619	1	142
3942-300-7-SL-2P	7314150364596	10	142
3942-300-7-SL-5P	7314150364602	5	142
3942-WOOD-SET-12P	7314150511525	6	143
3942-WOOD-SET-5P	7314150401680	5	143
3943-C30-JT-F	7314150422869	10	142
3943-C30-JT-M	7314150422876	10	142
3943-C35-JT-C	7314150422937	10	142
3943-C35-JT-M	7314150422883	10	142
3943-R28-UT-C-2P	7314150422951	10	142
3943-S20-JT-F	7314150422944	10	142
3944-300-3-MEAT-1P	7314150364862	10	143
3946-100-DG-ST-2P	7314150478644	10	141
3946-150-10-HST-1P	7314150478156	10	141
3946-150-6-DSL-1P	7314150478101	10	141
3946-150-6-SL-1P	7314150364916	5	143
3946-150-8-HST-1P	7314150478132	10	140
3946-150-DG-ST-2P	7314150478668	10	141
3946-228-10-HST-1P	7314150478255	10	141
3946-228-3-ST-1P	7314150364886	5	143
3946-228-6-DSL-1P	7314150478217	10	141
3946-228-8-HST-1P	7314150478231	10	140
3946-300-10-HST-1P	7314150478323	10	141
3946-300-2-CB-1P	7314150478354	10	143
3946-300-6-DSL-1P	7314150478286	10	141
3946-300-8-HST-1P	7314150478309	10	140
3946-457-2-CB-1P	7314150478378	10	143
396-BLADE	7311518299057	100	620
396-BLADE-1P	7311518330613	1	620
396-HP	7311518152284	4	620
396-HP-BLADE	7311518156404	200	621
396-INS	7314150422708	10	549
396-JS	7311518223250	4	620
396-JS-BLADE	7311518223267	200	621
396-JT	7311518168056	4	620
396-JT-BLADE	7311518168063	200	621
396-LAP	7311518172367	10	620
4-138-06-1-0	7311518020927	10	29
4-138-06-1-2	7311518000592	5	29

* Until stocks last

4-138-08-1-0	7311518020934	10	29
4-138-08-1-2	7311518000615	5	29
4-138-10-1-0	7311518020958	10	29
4-138-10-1-2	7311518000646	5	29
4-138-12-1-0	7311518020965	5	29
4-138-12-1-2	7311518194734	5	29
4-140-06-1-0	7311518020989	10	29
4-140-08-1-0	7311518020996	10	29
4-140-08-1-2	7311518028169	5	29
4-140-10-1-0	7311518022488	10	29
4-140-10-1-2	7311518194741	5	29
4-142-06-1-0	7311518021016	10	29
4-142-08-1-0	7311518021023	10	29
4-142-10-1-0	7311518021030	10	29
4-144-08-2-0	7311518021054	10	29
4-144-08-2-2	7311518201319	5	30
4-152-08-2-2	7311518000691	5	30
4-153-08-1-2	7311518000707	5	30
4-154-08-2-2	7311518000714	10	30
4-155-08-2-0	7311518116194	10	30
4-155-10-2-0	7311518116200	5	30
4-183-04-2-0	7311518021108	10	30
4-183-04-2-2	7311518021401	5	30
4-183-05-2-0	7311518021122	10	30
4-183-05-2-2	7311518021418	5	30
4-183-06-2-0	7311518021139	10	30
4-183-06-2-2	7311518000769	5	30
4-183-07-2-0	7311518021146	10	30
4-183-07-2-2	7311518194710	5	30
4-183-08-2-0	7311518021153	10	30
4-183-08-2-2	7311518194727	5	30
4-183-10-2-0	7311518021160	10	30
4-186-04-2-0	7311518021191	10	30
4-186-04-2-2	7311518021425	5	30
4-186-05-2-0	7311518021214	10	30
4-186-05-2-2	7311518028213	5	30
4-186-06-2-0	7311518021221	10	30
4-186-06-2-2	7311518000837	5	30
4-186-07-2-0	7311518021238	10	30
4-186-08-2-0	7311518021245	10	30
4-186-45-2-0*	7311518021207	10	30
4-187-04-2-0	7311518021269	10	31
4-187-05-2-0	7311518021283	10	31
4-187-05-2-2	7311518201449	5	31
4-187-06-2-0	7311518021290	10	31
4-187-06-2-2	7311518022464	5	31
4-187-07-2-0	7311518021306	10	31
4-187-45-2-0*	7311518021276	10	31
4-188-05-2-0	7311518021337	10	31
4-188-05-2-2	7311518201456	5	31
4-188-06-2-0	7311518021344	10	31
4-190-06-2-2	7311518000899	5	31
4-190-07-2-0	7311518021375	10	31
4-190-07-2-2	7311518000905	5	31
4-190-08-2-0	7311518021382	10	31
4-190-08-2-2	7311518000912	5	31
4-192-06-2-0	7311518021412	10	31
4-192-06-2-2	7311518201463	5	31
4-192-07-2-0	7311518021429	10	31
4-192-08-2-0	7311518021436	10	31
4-192-08-2-2	7311518201487	5	31
4-202-85-2-0	7311518021474	10	31
4-204-85-2-0	7311518021498	10	31
4-272-05-3-2	7311518201500	5	32
4-272-06-3-0	7311518021597	10	32
4-272-06-3-2	7311518001025	5	32
400.002.050	7314150249848	1	595
400.003.020	8412814403205	1	595
400.003.030	8412814403304	1	595
401-16	7314150400270	12	271
401-28	7314150384082	12	272
402-15-95	7314150485604	1	273
402-35	7314150384099	6	272
402-76*	7314150384105	6	272
402-95-SET	7314150400997	1	273
4020L-M-3.2	7314151405038	5	45
4020L-M-3.5	7314151077709	5	45
4020L-M-4	7314151077716	5	45
4020L-M-4.5	7314151077723	5	45
4020L-M-5	7314151077730	5	45
4020L-M-5.5	7314151077747	5	45
4040M-10-11	7314151078287	1	61
4040M-10-13	7314153000750	1	61
4040M-12-13	7314151078294	1	61
4040M-13-17*	7314151804565	1	61
4040M-14-15	7314151078300	1	61
4040M-16-17	7314151078317	1	61
4040M-16-18*	7314151839635	1	61
4040M-18-19	7314151078324	1	61
4040M-20-22*	7314151078331	1	61
4040M-21-23*	7314151078348	1	61
4040M-24-27	7314151831974	1	61
4040M-6-7	7314151831967	1	61
4040M-8-9	7314151078270	1	61
4040M/6T	7314150112197	1	61
4040M/S6	7314150112180	1	61



4040Z-1/2-9/16*



4040Z-1/2-9/16*	7314151831998	1	61
4040Z-13/16-7/8*	7314150355099	1	61
4040Z-3/8-7/16*	7314151831981	1	61
4040Z-5/8-11/16*	7314151832001	1	61
4040Z-5/8-3/4*	7314153001023	1	61
405-1000	7314150399758	5	528
405-1000-M	7314150399765	5	528
405-400	7314150399673	5	528
405-400-M	7314150399680	5	528
405-600	7314150399697	5	528
405-600-M	7314150399703	5	528
405-800	7314150399710	10	528
405-800-M	7314150399741	5	528
405L-400	7314150400461	10	528
405L-400-M	7314150400492	5	528
405L-600	7314150400478	10	528
405L-600-M	7314150400485	5	528
406-300	7314150183678	1	528
406-300-M	7314150186358	5	528
406-400	7314150183685	5	528
406-400-M	7314150183838	5	528
406-500	7314150183692	5	528
406-500-M	7314150186365	5	528
406-600	7314150245819	5	528
406-600-M	7314150245840	5	528
406-800	7314150245826	5	528
406P-400	7314150302574	10	528
406P-600	7314150302581	10	528
406T-225	7314150315130	10	529
407-1000*	7314150369928	6	581
407-1400*	7314150373703	6	581
407-700*	7314150369911	5	581
407F-1000	7314150383801	6	581
407F-1400	7314150383818	6	581
407F-700	7314150383795	6	581
40B-115-165	7314153011879	25	62
40B-115-165-SP	7314153024459	1	62
40B-150-230	7314153024534	10	62
40B-165-230*	7314150214587	1	62
40B-19-50	7314153011848	25	62
40B-19-50-SP	7314153024473	1	62
40B-22-35*	7314150214563	1	62
40B-32-75	7314153011855	25	62
40B-32-75-SP	7314153024497	1	62
40B-50-120	7314153011862	20	62
40B-50-120-SP	7314153024510	1	62
4106-115-165	7314153024572	25	62
4106-150-230	7314153024596	10	62
4106-19-50	7314153011886	10	62
4106-20-35*	7314150213764	1	62
4106-32-75	7314153011893	25	62
4106-50-120	7314153024558	25	62
411-26	7314150412068	4	273
411-26-95	7314150412259	50	273
411-35	7314150412082	4	273
411-35-95	7314150412266	50	273
411-42	7314150412112	6	273
411-42-95	7314150412273	50	273
411-63	7314150412136	5	273
411-63-95	7314150412280	30	273
412-26-MULTI	7314150412174	5	273
412-26-MULTI-95	7314150412303	150	274
412-28-PEX	7314150412150	5	273
412-28-PEX-95	7314150412297	30	274
4124-JT-H	7311518267803	4	620
4128-JT-H	7311518267810	4	620
4130	7314150100019	3	237
413005000	8413345011860	12	584
413010000	8413345011877	12	584
413015000	8413345011884	12	584
413020000	8413345011891	6	584
413030000	8413345119986	1	584
413040000	8413345119993	1	584
4131	7314150100026	3	237
414-10	7311518238148	4	559
414-12	7311518238155	4	559
414-14	7311518238162	4	559
414-15	7311518238179	4	559
414-16	7311518238186	4	559
414-18	7311518238193	4	559
414-20	7311518238209	4	559
414-22	7311518238216	4	559
414-25	7311518238223	4	559
414-28	7311518238230	4	559
414-30	7311518238247	4	559
414-32	7311518238254	4	559
414-35	7311518238261	4	559
414-38	7311518238278	4	559
414-6	7311518238117	4	559
414-8	7311518238131	4	559
414-S3-EUR	7311518249205	1	559
416-1000	7314150314027	10	528
416-1200	7314150308798	10	528
416-1500	7314150314034	10	528
416-1800	7314150308804	10	528
416-2000	7314150308811	10	528



416-400	7314150314003	10	528
416-600	7314150308781	10	528
416-800	7314150314010	10	528
416-SET-1	7314150308828	5	529
416-SET-2	7314150308835	5	529
416-SET+BAG	7314150365470	1	528
41RM-10	7314153014429	60	47
41RM-11	7314153014436	60	47
41RM-12	7314153014443	60	47
41RM-13	7314153014450	60	47
41RM-14	7314153014467	30	47
41RM-17	7314153014474	30	47
41RM-19	7314153014481	30	47
41RM-21	7314150219742	30	47
41RM-8	7314153014412	60	47
41RM/SH8	7314150220656	10	48
41RZ-1/2	7314150359011	1	47
41RZ-11/16	7314150359042	1	47
41RZ-13/16	7314150359066	30	47
41RZ-3/4	7314150359059	1	47
41RZ-3/8	7314150358991	1	47
41RZ-5/16	7314150358984	1	47
41RZ-5/8	7314150359035	30	47
41RZ-7/16	7314150359004	1	47
41RZ-7/8	7314150359073	1	47
41RZ-9/16	7314150359028	1	47
420SC-25	7314150169825	10	575
420SC-50	7314150169832	5	575
420SH-100-200	7314150359691	10	574
420SH-120-1000	7314150359790	6	574
420SH-120-1250	7314150359806	6	574
420SH-120-1500	7314150359813	6	574
420SH-120-250	7314150359707	8	574
420SH-120-300	7314150359745	8	574
420SH-120-400	7314150359752	6	574
420SH-120-500	7314150359769	6	574
420SH-120-600	7314150359776	6	574
420SH-120-800	7314150359783	6	574
420SH-140-400	7314150359820	6	574
420SH-175-400	7314150359837	6	574
420SH-50-100	7314150359646	10	574
420SH-50-200	7314150359653	10	574
420SH-60-120	7314150359660	12	574
420SH-60-300	7314150359677	12	574
420SH-80-160	7314150359684	12	574
4211-11-6T	7311518152000	4	620
4211-14-6T	7311518128883	4	620
4212-11-6T	7311518002060	4	620
4212-14-6T	7311518002077	4	620
422P-10	7311518248369	4	560
422P-12	7311518248376	4	560
422P-16	7311518248383	4	560
422P-20	7311518248390	4	560
422P-25	7311518248406	4	560
422P-6	7311518248352	4	560
4231	7314150100033	3	239
4239	7314150100088	3	239
424P-10	7311518238315	4	558
424P-12	7311518238322	4	558
424P-14	7311518238339	4	558
424P-15	7311518238346	4	558
424P-16	7311518238353	4	558
424P-18	7311518238360	4	558
424P-20	7311518238377	4	558
424P-22	7311518238384	4	558
424P-24	7311518238391	4	558
424P-25	7311518238407	4	558
424P-26	7311518238414	4	558
424P-28	7311518238421	4	558
424P-30	7311518238438	4	558
424P-32	7311518238445	4	558
424P-35	7311518238452	4	558
424P-38	7311518238469	4	558
424P-4	7311518238285	4	558
424P-40	7311518238476	4	558
424P-6	7311518238292	4	558
424P-8	7311518238308	4	558
424P-S3-EUR	7311518249199	1	558
424P-S6-EUR	7311518269968	1	559
424P-S6-GER	7311518280086	1	559
424P-S6-LR	7314150423804	1	558
424P-S6-PP	7314150326662	1	559
424P-S8-EUR	7311518276393	1	559
425-081	7311518010669	1	560
425-082	7311518010676	1	560
425-083	7311518010683	1	560
425-10	7311518004613	4	560
425-12	7311518004620	4	560
425-14	7311518004637	4	560
425-15	7311518017767	4	560
425-16	7311518004644	4	560
425-18	7311518004651	4	560
425-20	7311518004668	4	560
425-22	7311518004675	4	560
425-24	7311518005993	4	560
425-25	7311518004682	4	560



425-26	7311518006006	4	560
425-28	7311518004699	4	560
425-30	7311518004705	4	560
425-32	7311518004712	4	560
425-35	7311518017774	4	560
425-38	7311518004729	4	560
425-4	7311518030810	4	560
425-40	7311518017781	4	560
425-6	7311518004590	4	560
425-8	7311518004606	4	560
426-1000	7311518004309	1	527
426-1200	7311518004316	1	527
426-400	7311518004255	1	527
426-600	7311518004279	1	527
426-800	7311518004293	1	527
426TOR9	7314150125319	10	529
427-13*	7314150403578	4	578
427-16	7311518025410	4	578
427-20	7311518025427	4	578
427-24*	7314150402878	4	578
427-700*	7314150338092	6	578
427-8*	7314150402854	4	578
427S-16*	7314150404247	4	578
427S-20*	7314150404261	4	578
428-16	7311518012380	4	578
428-700*	7314150338108	6	579
428F-13	7314150436392	4	578
428F-16	7314150436408	4	578
428F-20	7314150436422	4	578
428F-24	7314150436439	4	578
428F-8	7314150436378	4	578
428S-16*	7314150424030	4	578
428S-20*	7314150424047	4	578
429-13	7311518012250	4	578
429-16	7311518012403	4	578
429-20	7311518012410	4	578
429-8	7311518040703	4	578
42RM/S12	7314150384785	1	48
4307	7314151079444	1	62
4310	7314151079451	1	62
434-10	7311518238506	4	558
434-12	7311518238513	4	558
434-14	7311518238520	4	558
434-15	7311518238537	4	558
434-16	7311518238544	4	558
434-18	7311518238551	4	558
434-20	7311518238568	4	558
434-22	7311518238575	4	558
434-25	7311518238582	4	558
434-28	7311518238599	4	558
434-30	7311518238605	4	558
434-32	7311518238612	4	558
434-35	7311518238629	4	558
434-38	7311518238636	4	558
434-50	7311518285388	4	558
434-6	7311518238483	4	558
434-8	7311518238490	4	558
434-S3-EUR	7311518249212	1	558
434-S6-EUR	7311518267544	1	558
434-S6-LR	7314150423811	1	558
434-S6-PP	7314150326655	1	558
434-S8-EUR	7311518295110	1	558
439000000	8413345129282	1	459
439000001	7314150268788	1	459
439000003*	7314150309719	1	459
439000004*	7314150427666	1	459
4400-11	7311518200596	10	621
4400-11-BULK	7311518200633	10	621
4400-14	7311518200602	10	621
4400-14-BULK	7311518200640	10	621
440102500	8413345098977	10	581
440103000*	8413345098991	10	581
4411-1.00	7314150372744	1	157
4411-1.50	7314150372768	1	157
4411-10.00	7314150372973	1	157
4411-10.20	7314150372980	1	157
4411-10.50	7314150470488	1	157
4411-11.00	7314150372997	1	157
4411-11.50	7314150470495	1	157
4411-12.00	7314150373000	1	157
4411-12.50	7314150470501	1	157
4411-13.00	7314150373017	1	157
4411-2.00	7314150372775	1	157
4411-2.50	7314150372782	1	157
4411-3.00	7314150372799	1	157
4411-3.25	7314150372805	1	157
4411-3.30	7314150372812	1	157
4411-3.50	7314150372829	1	157
4411-4.00	7314150372836	1	157
4411-4.20	7314150372843	1	157
4411-4.25	7314150372850	1	157
4411-4.50	7314150372867	1	157
4411-5.00	7314150372874	1	157
4411-5.50	7314150372881	1	157
4411-6.00	7314150372898	1	157
4411-6.50	7314150372904	1	157

* Until stocks last



4411-6.80	7314150372911	1	157
4411-7.00	7314150372928	1	157
4411-7.50	7314150372935	1	157
4411-8.00	7314150372942	1	157
4411-8.50	7314150372959	1	157
4411-9.00	7314150372966	1	157
4411-9.50	7314150394463	1	157
4413-1.00	7314150371754	1	158
4413-1.50	7314150371761	1	158
4413-10.00	7314150372034	1	158
4413-10.20	7314150372041	1	158
4413-10.50	7314150470556	25	158
4413-11.00	7314150372058	1	158
4413-11.50	7314150470563	25	158
4413-12.00	7314150372065	1	158
4413-12.50	7314150470570	25	158
4413-13.00	7314150372072	1	158
4413-2.00	7314150371785	1	158
4413-2.50	7314150371792	1	158
4413-3.00	7314150371815	1	158
4413-3.25	7314150371822	1	158
4413-3.30	7314150371877	1	158
4413-3.50	7314150371884	1	158
4413-4.00	7314150371891	1	158
4413-4.20	7314150371907	1	158
4413-4.25	7314150371914	1	158
4413-4.50	7314150371921	1	158
4413-5.00	7314150371938	1	158
4413-5.50	7314150371945	1	158
4413-6.00	7314150371952	1	158
4413-6.50	7314150371969	1	158
4413-6.80	7314150371976	1	158
4413-7.00	7314150371983	1	158
4413-7.50	7314150371990	1	158
4413-8.00	7314150372003	1	158
4413-8.50	7314150372010	1	158
4413-9.00	7314150372027	1	158
4413-9.50	7314150394456	1	158
4415-1.00	7314150394210	1	159
4415-1.50	7314150394227	1	159
4415-10.00	7314150394401	1	159
4415-10.50	7314150470525	1	159
4415-11.00	7314150394418	1	159
4415-11.50	7314150470532	1	159
4415-12.00	7314150394425	1	159
4415-12.50	7314150470549	1	159
4415-13.00	7314150394432	1	159
4415-13.50	7314150441495	1	159
4415-14.00	7314150441501	1	159
4415-14.50	7314150441518	1	159
4415-15.00	7314150441525	1	159
4415-15.50	7314150441532	1	159
4415-16.00	7314150441549	1	159
4415-16.50	7314150441556	1	159
4415-17.00	7314150441563	1	159
4415-17.50	7314150441570	1	159
4415-18.00	7314150441587	1	159
4415-18.50	7314150441594	1	159
4415-19.00	7314150441600	1	159
4415-19.50	7314150441617	1	159
4415-2.00	7314150394234	1	159
4415-2.50	7314150394241	1	159
4415-20.00	7314150441624	1	159
4415-3.00	7314150394258	1	159
4415-3.25	7314150394265	1	159
4415-3.50	7314150394272	1	159
4415-4.00	7314150394289	1	159
4415-4.25	7314150394296	1	159
4415-4.50	7314150394302	1	159
4415-5.00	7314150394319	1	159
4415-5.50	7314150394326	1	159
4415-6.00	7314150394333	1	159
4415-6.50	7314150394340	1	159
4415-7.00	7314150394357	1	159
4415-7.50	7314150394364	1	159
4415-8.00	7314150394371	1	159
4415-8.50	7314150394388	1	159
4415-9.00	7314150394395	1	159
442	7311518002848	10	536
442 B	7314150008957	1	270
442-3P	7314150309610	10	536
4420-11	7311518200619	10	621
4420-11-BULK	7311518200657	10	621
4420-14	7311518200626	10	621
4420-14-BULK	7311518200664	10	621
443 B	7314150008971	1	270
4430	7314150100040	3	248
4435-12.4	7314150465163	1	160
444 B	7314150009008	1	270
4480/2-ZD	7311518276911	1	274
4480IM	7314150263165	1	274
4480MM	7314150263158	1	274
449	7311518005337	10	536
44Z-1/2-9/16	7314150375233	10	55
44Z-1/4-5/16	7314150375196	10	55
44Z-11/16-13/16	7314150375264	5	55





44Z-11/16-3/4	7314150375257	5	55
44Z-3/8-7/16	7314150375219	10	55
44Z-5/16-3/8	7314150375202	10	55
44Z-5/8-3/4	7314150375240	5	55
44Z-7/16-1/2	7314150375226	10	55
451	7311518014506	10	536
4511-0.50-10P	7314150373079	1	157
4511-0.75-10P	7314150373062	1	157
4511-1.00-10P	7314150373055	1	157
4511-1.50-10P	7314150373086	1	157
4511-1.75-10P	7314150373093	1	157
4511-10.00-5P	7314150373444	1	157
4511-10.20-5P	7314150373468	1	157
4511-10.30-5P	7314150373475	1	157
4511-10.50-5P	7314150373482	1	157
4511-10.80-5P	7314150373499	1	157
4511-11.00-5P	7314150373505	1	157
4511-11.50-5P	7314150373512	1	157
4511-12.00-5P	7314150373529	1	157
4511-12.50-5P	7314150373536	1	157
4511-12.80-5P	7314150373543	1	157
4511-13.00-5P	7314150373550	1	157
4511-13.50-1P	7314150373567	1	157
4511-14.00-1P	7314150373574	1	157
4511-14.50-1P	7314150373581	1	157
4511-15.00-1P	7314150373598	1	157
4511-15.50-1P	7314150373604	1	157
4511-16.00-1P	7314150373611	1	157
4511-16.50-1P	7314150373628	1	157
4511-17.00-1P	7314150373635	1	157
4511-17.50-1P	7314150373642	1	157
4511-18.00-1P	7314150373659	1	157
4511-18.50-1P	7314150373673	1	157
4511-19.00-1P	7314150373680	1	157
4511-19.50-1P	7314150373697	1	157
4511-2.00-10P	7314150373109	1	157
4511-2.50-10P	7314150373116	1	157
4511-2.70-10P	7314150373123	1	157
4511-2.90-10P	7314150373130	1	157
4511-20.00-1P	7314150373666	1	157
4511-3.00-10P	7314150373147	1	157
4511-3.10-10P	7314150373185	1	157
4511-3.25-10P	7314150373192	1	157
4511-3.30-10P	7314150373208	1	157
4511-3.50-10P	7314150373215	1	157
4511-3.80-10P	7314150373222	1	157
4511-4.00-10P	7314150373239	1	157
4511-4.20-10P	7314150373246	1	157
4511-4.50-10P	7314150373253	1	157
4511-4.80-10P	7314150373260	1	157
4511-5.00-10P	7314150373277	1	157
4511-5.20-10P	7314150373284	1	157
4511-5.50-10P	7314150373291	1	157
4511-6.00-10P	7314150373307	1	157
4511-6.20-10P	7314150373314	1	157
4511-6.50-10P	7314150373321	1	157
4511-6.80-10P	7314150373338	1	157
4511-7.00-10P	7314150373345	1	157
4511-7.20-10P	7314150373352	1	157
4511-7.50-10P	7314150373369	1	157
4511-7.80-10P	7314150373376	1	157
4511-8.00-10P	7314150373383	1	157
4511-8.50-10P	7314150373390	1	157
4511-8.60-10P	7314150373406	1	157
4511-8.80-10P	7314150373413	1	157
4511-9.00-10P	7314150373420	1	157
4511-9.20-10P	7314150373437	1	157
4511-9.50-10P	7311518339081	1	157
4511-9.60-10P	7314150373451	1	157
4511-SET-19	7314150373031	1	157
4511-SET-25	7314150373048	1	157
4511-SET-6	7314150373024	1	157
4513-1.00-10P	7314150372119	1	158
4513-1.50-10P	7314150372126	1	158
4513-1.75-10P	7314150372133	1	158
4513-10.00-5P	7314150391998	1	158
4513-10.20-5P	7314150392001	1	158
4513-10.30-5P	7314150392018	1	158
4513-10.50-5P	7314150392025	1	158
4513-10.80-5P	7314150392032	1	158
4513-11.00-5P	7314150392049	1	158
4513-11.50-5P	7314150392056	1	158
4513-12.00-5P	7314150392063	1	158
4513-12.50-5P	7314150392070	1	158
4513-12.80-5P	7314150392087	1	158
4513-13.50-1P	7314150392100	1	158
4513-14.00-1P	7314150392117	1	158
4513-14.50-1P	7314150392124	1	158
4513-15.00-1P	7314150392131	1	158
4513-15.50-1P	7314150392148	1	158
4513-16.00-1P	7314150392155	1	158
4513-16.50-1P	7314150392162	1	158
4513-17.00-1P	7314150392179	1	158
4513-17.50-1P	7314150392186	1	158
4513-18.00-1P	7314150392193	1	158
4513-18.50-1P	7314150392209	1	158



4513-19.00-1P	7314150392216	1	158
4513-19.50-1P	7314150392223	1	158
4513-2.00-10P	7314150372140	1	158
4513-2.50-10P	7314150372157	1	158
4513-2.70-10P	7314150372164	1	158
4513-2.90-10P	7314150372171	1	158
4513-3.00-10P	7314150372188	1	158
4513-3.10-10P	7314150372195	1	158
4513-3.25-10P	7314150372201	1	158
4513-3.30-10P	7314150372218	1	158
4513-3.50-10P	7314150372225	1	158
4513-3.80-10P	7314150372232	1	158
4513-4.00-10P	7314150372249	1	158
4513-4.20-10P	7314150372256	1	158
4513-4.50-10P	7314150372263	1	158
4513-4.80-10P	7314150372270	1	158
4513-5.00-10P	7314150372287	1	158
4513-5.20-10P	7314150372294	1	158
4513-5.50-10P	7314150372300	1	158
4513-6.00-10P	7314150372317	1	158
4513-6.20-10P	7314150372324	1	158
4513-6.50-10P	7314150372331	1	158
4513-6.80-10P	7314150372348	1	158
4513-7.00-10P	7314150372355	1	158
4513-7.20-10P	7314150372362	1	158
4513-7.50-10P	7314150372379	1	158
4513-7.80-10P	7314150372386	1	158
4513-8.00-10P	7314150372393	1	158
4513-8.50-10P	7314150372409	1	158
4513-8.60-10P	7314150372416	1	158
4513-8.80-10P	7314150372423	1	158
4513-9.00-10P	7314150372430	1	158
4513-9.20-10P	7314150372447	1	158
4513-9.50-10P	7314150372454	1	158
4513-9.60-10P	7314150372461	1	158
4513-SET-19	7314150372096	1	158
4513-SET-25	7314150372102	1	158
4513-SET-6	7314150372089	1	158
4515-1.00-10P	7314150441228	1	159
4515-1.50-10P	7314150441235	1	159
4515-10.00-10P	7314150441426	1	159
4515-10.50-5P	7314150441433	1	159
4515-11.00-5P	7314150441440	1	159
4515-11.50-5P	7314150441457	1	159
4515-12.00-5P	7314150441464	1	159
4515-12.50-5P	7314150441471	1	159
4515-13.00-5P	7314150441488	1	159
4515-2.00-10P	7314150441242	1	159
4515-2.50-10P	7314150441259	1	159
4515-3.00-10P	7314150441266	1	159
4515-3.25-10P	7314150441273	1	159
4515-3.50-10P	7314150441280	1	159
4515-4.00-10P	7314150441297	1	159
4515-4.25-10P	7314150441303	1	159
4515-4.50-10P	7314150441310	1	159
4515-5.00-10P	7314150441327	1	159
4515-5.50-10P	7314150441334	1	159
4515-6.00-10P	7314150441341	1	159
4515-6.50-10P	7314150441358	1	159
4515-7.00-10P	7314150441365	1	159
4515-7.50-10P	7314150441372	1	159
4515-8.00-10P	7314150441389	1	159
4515-8.50-10P	7314150441396	1	159
4515-9.00-10P	7314150441402	1	159
4515-9.50-10P	7314150441419	1	159
4515-SET-19	7314150394449	1	159
4515-SET-25	7314150441709	1	159
4518-3	7314151716547	1	361
4518-4	7314151716622	1	361
4518-5	7314151716899	1	361
4519-1	7314151716974	1	360
4519-1/S	7314151843762	1	359
4519-2	7314151717193	1	360
4519-3	7314151717278	1	360
4521N-0	7314151837723	1	361
4521N-00	7314151837716	1	361
4521N-A	7314151837730	1	361
4521N-B	7314151837747	1	361
4521N-C	7314151837754	1	361
4521N-D	7314151837761	1	361
4521N-E	7314151837778	1	361
4521N-F	7314151837785	1	361
4521N-G	7314151837792	1	361
4521N-H	7314151837808	1	361
4521N-I	7314151837815	1	361
4521N-K	7314151837822	1	361
4521N-L	7314151837839	1	361
4521N-M	7314151837846	1	361
4521N-S	7314151839789	1	361
4521N-T	7314151839796	1	361
4521N/7	7314151839802	1	361
4522-1	7314151081591	1	361
4522-2	7314151081614	1	361
4523G	7314151846695	1	361
4524G	7314151718596	1	361
4528-1	7314151718671	1	359

Item	Stock	Unit	Price
4528M1	7314151718916	1	359
4528M2	7314151719050	1	359
4528M3	7314151719135	1	359
4528M4	7314151719210	1	359
4528M5	7314151719487	1	359
4529-15	7314151719647	1	358
4529-8	7314151719562	1	358
4530	7314150100095	3	250
4532-0	7314151719722	1	358
4532-A	7314151082109	1	358
4532-AL	73141502221912	1	358
4532-B	7314151082116	1	358
4532-BL	73141502221929	1	358
4532-C	7314151082123	1	358
4532-CD/S	7314151818067	1	358
4532-CL	73141502221936	1	358
4532-D	7314151082130	1	358
4532-E	7314151082147	1	358
4532-EFG/S	7314151838386	1	358
4532-F	7314151082154	1	358
4532-G	7314151082161	1	358
4532-G-SO	7314151841003	1	358
4532-H	7314151719999	1	358
4532-H/S	7314151838393	1	358
4532-OAB/S	7314151818050	1	358
4532K1	7314151082185	1	358
4532K2	7314151082192	1	358
4532K3	7314151082208	1	358
4532K4	7314151720148	1	358
4532LK1	7314151082215	1	358
4532LK2	7314151082222	1	358
4532LK3	7314151082239	1	358
4532LK4	7314151082246	1	358
4532LK5	7314151720223	1	358
4532ST/5	7314151720490	1	358
4533HP	7314151793043	1	358
4533HP/S	7314150224487	1	358
4533HPK	7314150224500	1	358
4533M	7314151793050	1	358
4533M/S	7314150224494	1	358
4533MK	7314150224517	1	358
4537-1	7314151720650	1	359
4537-2	7314151720735	1	359
4537-3	7314151720810	1	359
4537-4	7314151721039	1	359
4540-17	7314150125005	1	360
4540-17/S	7314150225248	1	360
4540-25	7314150125012	1	360
4540-25/S	7314150225286	1	360
4541-A	7314151082413	1	359
4541-B	7314151082420	1	359
4542-A	7314151082451	1	359
4542-B	7314151082468	1	359
4543-1	7314151082499	1	359
4543-1/S	7314151818623	1	359
4543-10	7314151721466	1	359
4543-2	7314151082505	1	359
4543-2/S	7314151818661	1	359
4543-20	7314151721541	1	359
4543-3	7314151721381	1	359
4543-3/S	7314151818708	1	359
4543-30	7314151721626	1	359
4544-1	7314151844004	1	359
4544-10	7314151844042	1	359
4544-110/S	7314150224777	1	359
4544-2	7314151844011	1	359
4544-20	7314151844059	1	359
4544-220/S	7314150224784	1	359
4544-3	7314151844028	1	359
4544-30	7314151844066	1	359
4544-4	7314151844035	1	359
4544-440/S	7314150224791	1	359
4545-1	7314151082543	1	362
4545-2	7314151082550	1	362
4545-3	7314151082567	1	362
4545-4	7314151722272	1	362
4545-5	7314151722357	1	362
4545-N1	7314151722432	1	361
4545-N11	7314150249169	1	361
4545-N2	7314151804947	1	361
4545-N21	7314150249176	1	361
4551-A	7314151082628	1	360
4551-B	7314151722784	1	360
4551-C	7314151082642	1	360
4551-D	7314151082659	1	360
4552-1	7314151722944	1	360
4552-2	7314151723088	1	360
4552-3	7314151723163	1	360
4553	7314151830649	1	362
4559-12	7314150113132	1	242
4559-12A JC	7314150223909	1	242
4559-18	7314150024513	8	242
4559-18B JC	7314150113880	1	242
4559-24	7314150024520	6	242
4559-24B JC	7314150113897	1	242
4559-30	7314150024537	5	242

* Until stocks last

Item	Stock	Unit	Price
4559-30B JC	7314150113903	1	242
4559-36	7314150024544	3	242
4559-36B JC	7314150113910	1	242
4559-42	7314150024551	2	242
4559-42A JC	7314150208876	1	242
4560-210	7314150178995	1	243
4574	7314151799014	1	360
4577	7314151838348	1	362
4578	7314150222308	1	361
4579	7314150222018	1	362
4580N/7	7314151301361	1	360
4581N-1	7314151724139	1	360
4581NA	7314151301200	1	360
4581NB	7314151301217	1	360
4581NB2	7314151724276	1	360
4581NC	7314151301224	1	360
4582N-1	7314151724214	1	360
4582N-2	7314151724481	1	360
4582NA	7314151301248	1	360
4582NB	7314151301255	1	360
4583N-1	7314151724566	1	360
4583N-2	7314151724641	1	360
4583NA	7314151301279	1	360
4583NB	7314151301286	1	360
4590SHS5	7314150384822	4	362
4591	7314151804039	1	362
4592	7314151804046	1	362
4593	7314151804053	1	362
4594VWT4*	7314150403639	5	330
45S/H1.5	7314150218530	1	172
45S/H1.5-2P	7314150261505	50	172
45S/H2	7314150218547	1	172
45S/H2-2P	7314150261512	50	172
45S/H2.5	7314150218554	1	172
45S/H2.5-2P	7314150261529	50	172
45S/H3	7314150218561	1	172
45S/H3-2P	7314150261536	50	172
45S/PH1	7314150218516	1	172
45S/PH1-2P	7314150261482	50	172
45S/PH2	7314150218523	1	172
45S/PH2-2P	7314150261499	50	172
4610-1	7314151724993	1	362
4611-2	7314151725372	1	362
4611-3	7314150125043	1	362
4614-1	7314151725457	1	360
4614-2	7314151725532	1	360
4626-10.0	7314150457670	1	161
4626-4.0	7314150457632	1	161
4626-5.0	7314150457649	1	161
4626-6.0	7314150457656	1	161
4626-8.0	7314150457663	1	161
4629-10.0	7314150465385	1	162
4629-4.0	7314150465347	1	162
4629-5.0	7314150465354	1	162
4629-6.0	7314150465361	1	162
4629-8.0	7314150465378	1	162
4629-SET-5	7314150467204	10	162
4630	7314150216154	1	596
4641-10-120	7314150383085	1	156
4641-10-200	7314150383115	1	156
4641-10-400	7314150383207	1	156
4641-10-600	7314150383221	1	156
4641-11-150	7314150383122	1	156
4641-12-150	7314150383139	1	156
4641-12-200	7314150383146	1	156
4641-12-400	7314150383238	1	156
4641-12-600	7314150383245	1	156
4641-13-150	7314150383153	1	156
4641-14-150	7314150383160	1	156
4641-14-400	7314150383252	1	156
4641-14-600	7314150383269	1	156
4641-16-150	7314150383177	1	156
4641-16-400	7314150383276	1	156
4641-16-600	7314150383283	1	156
4641-18-400	7314150383290	1	156
4641-18-600	7314150383306	1	156
4641-20-400	7314150383313	1	156
4641-20-600	7314150383320	1	156
4641-22-400	7314150383337	1	156
4641-24-400	7314150383344	1	156
4641-25-400	7314150383351	1	156
4641-3-60	7314150382859	1	156
4641-4-75	7314150382866	1	156
4641-5-150	7314150382880	1	156
4641-5-85	7314150382873	1	156
4641-5-5-85	7314150382897	1	156
4641-6-100	7314150383016	1	156
4641-6-150	7314150383023	1	156
4641-6-400	7314150383184	1	156
4641-6-5-100	7314150383030	1	156
4641-7-100	7314150383047	1	156
4641-8-120	7314150383054	1	156
4641-8-200	7314150383061	1	156
4641-8-400	7314150383191	1	156
4641-9-120	7314150383078	1	156
4641-PB	7314150383368	1	156





4643-PB	7314150441679	1	156
4651-10-1000	7314150386413	1	155
4651-10-110	7314150386345	1	155
4651-10-160	7314150386352	1	155
4651-10-160-10P	7314150475483	1	155
4651-10-210	7314150386369	1	155
4651-10-210-10P	7314150475513	1	155
4651-10-260	7314150386376	1	155
4651-10-310	7314150386383	1	155
4651-10-450	7314150386390	1	155
4651-10-600	7314150386406	1	155
4651-12-1000	7314150386581	1	155
4651-12-160	7314150386529	1	155
4651-12-160-10P	7314150475490	1	155
4651-12-210	7314150386536	1	155
4651-12-210-10P	7314150475520	1	155
4651-12-260	7314150386543	1	155
4651-12-310	7314150386550	1	155
4651-12-450	7314150386567	1	155
4651-12-600	7314150386574	1	155
4651-14-1000	7314150386659	1	155
4651-14-160	7314150386598	1	155
4651-14-210	7314150386604	1	155
4651-14-260	7314150386611	1	155
4651-14-310	7314150386628	1	155
4651-14-450	7314150386635	1	155
4651-14-600	7314150386642	1	155
4651-15-160	7314150386666	1	155
4651-15-260	7314150386673	1	155
4651-15-450	7314150386680	1	155
4651-16-1000	7314150386765	1	155
4651-16-160	7314150386697	1	155
4651-16-210	7314150386710	1	155
4651-16-260	7314150386727	1	155
4651-16-310	7314150386734	1	155
4651-16-450	7314150386741	1	155
4651-16-600	7314150386758	1	155
4651-18-250	7314150386789	1	155
4651-18-450	7314150386796	1	155
4651-20-250	7314150386802	1	155
4651-20-450	7314150386819	1	155
4651-22-250	7314150386826	1	155
4651-22-450	7314150386833	1	155
4651-24-250	7314150386840	1	155
4651-24-450	7314150386857	1	155
4651-25-250	7314150386864	1	155
4651-25-450	7314150386871	1	155
4651-28-250	7314150386888	1	155
4651-28-450	7314150386895	1	155
4651-30-250	7314150386901	1	155
4651-30-450	7314150386918	1	155
4651-32-450	7314150386925	1	155
4651-5-110	7314150385683	1	154
4651-5-110-10P	7314150475407	1	154
4651-5-160	7314150385690	1	154
4651-5-160-10P	7314150475438	1	154
4651-5-260	7314150385713	1	154
4651-5,5-110	7314150385720	1	154
4651-5,5-110-10P	7314150475414	10	154
4651-5,5-160	7314150385737	1	154
4651-5,5-160-10P	7314150475445	1	154
4651-6-110	7314150385744	1	155
4651-6-110-10P	7314150475421	1	155
4651-6-160	7314150385751	1	155
4651-6-160-10P	7314150475452	1	155
4651-6-210	7314150385768	1	155
4651-6-260	7314150385775	1	155
4651-6-310	7314150385782	1	155
4651-6,5-110	7314150475391	50	155
4651-6,5-160	7314150385799	1	155
4651-6,5-160-10P	7314150475469	1	155
4651-6,5-210	7314150385805	1	155
4651-6,5-260	7314150385812	1	155
4651-6,5-310	7314150385829	1	155
4651-7-110	7314150385836	1	155
4651-7-160	7314150386253	1	155
4651-8-110	7314150386277	1	155
4651-8-160	7314150386284	1	155
4651-8-160-10P	7314150475476	1	155
4651-8-210	7314150386291	1	155
4651-8-210-10P	7314150475506	1	155
4651-8-260	7314150386307	1	155
4651-8-310	7314150386314	1	155
4651-8-460	7314150386321	1	155
4651-SET-5	7314150475537	1	155
4651-SET-7	7314150475544	1	155
4652-10-110	7314150385119	1	155
4652-10-160	7314150385126	1	155
4652-10-160-10P	7314150475322	1	155
4652-10-210	7314150385133	1	155
4652-10-210-10P	7314150475353	1	155
4652-10-260	7314150385140	1	155
4652-10-310	7314150385164	1	155
4652-10-450	7314150385171	1	155
4652-10-600	7314150385188	1	155
4652-11-160	7314150385195	1	155



4652-11-260	7314150385218	1	155
4652-12-1000	7314150385287	1	155
4652-12-160	7314150385225	1	155
4652-12-160-10P	7314150475339	1	155
4652-12-210	7314150385232	1	155
4652-12-210-10P	7314150475360	1	155
4652-12-260	7314150385249	1	155
4652-12-310	7314150385256	1	155
4652-12-450	7314150385263	1	155
4652-12-600	7314150385270	1	155
4652-13-310	7314150385300	1	155
4652-14-1000	7314150385379	1	155
4652-14-160	7314150385317	1	155
4652-14-210	7314150385324	1	155
4652-14-260	7314150385331	1	155
4652-14-310	7314150385348	1	155
4652-14-450	7314150385355	1	155
4652-14-600	7314150385362	1	155
4652-15-260	7314150385393	1	155
4652-16-1000	7314150385478	1	155
4652-16-210	7314150385416	1	155
4652-16-260	7314150385423	1	155
4652-16-310	7314150385430	1	155
4652-16-450	7314150385447	1	155
4652-16-600	7314150385454	1	155
4652-18-1000	7314150385515	1	155
4652-18-200	7314150385485	1	155
4652-18-300	7314150385492	1	155
4652-18-450	7314150385508	1	155
4652-20-1000	7314150385560	1	155
4652-20-200	7314150385522	1	155
4652-20-300	7314150385539	1	155
4652-20-450	7314150385546	1	155
4652-20-600	7314150385553	1	155
4652-22-1000	7314150385607	1	155
4652-22-250	7314150385577	1	155
4652-22-450	7314150385584	1	155
4652-22-600	7314150385591	1	155
4652-24-250	7314150385614	1	155
4652-24-450	7314150385621	1	155
4652-25-1000	7314150385652	1	155
4652-25-250	7314150385638	1	155
4652-25-450	7314150385645	1	155
4652-26-250	7314150385669	1	155
4652-26-450	7314150385676	1	155
4652-3-110	7314150475216	50	155
4652-3,5-110	7314150475223	50	155
4652-4-110	7314150384365	1	155
4652-4-160	7314150384372	1	155
4652-5-110	7314150384815	1	155
4652-5-110-10P	7314150475247	1	155
4652-5-160	7314150384839	1	155
4652-5-160-10P	7314150475278	1	155
4652-5-210	7314150384846	1	155
4652-5,5-110	7314150384853	1	155
4652-5,5-110-10P	7314150475254	10	155
4652-5,5-160	7314150384860	1	155
4652-5,5-160-10P	7314150475285	1	155
4652-5,5-210	7314150475230	50	155
4652-6-110	7314150384877	1	155
4652-6-110-10P	7314150475261	1	155
4652-6-160	7314150384891	50	155
4652-6-160-10P	7314150475292	1	155
4652-6-210	7314150384907	1	155
4652-6-260	7314150384969	1	155
4652-6,5-110	7314150384976	1	155
4652-6,5-160	7314150384990	1	155
4652-6,5-160-10P	7314150475308	1	155
4652-7-110	7314150385003	1	155
4652-7-160	7314150391981	1	155
4652-8-110	7314150385034	1	155
4652-8-160	7314150385058	1	155
4652-8-160-10P	7314150475315	1	155
4652-8-210	7314150385065	1	155
4652-8-210-10P	7314150475346	1	155
4652-8-260	7314150385072	1	155
4652-8-460	7314150385089	1	155
4652-9-160	7314150385096	1	155
4652-9-210	7314150385102	1	155
4652-SET-5	7314150475377	1	156
4652-SET-7	7314150475384	1	156
4655-FLAT-250	7314150387823	1	156
4655-HOLLOW-240	7314150387847	1	156
4655-POINT-250	7314150387816	1	156
4655-SLOT-25032	7314150387885	1	156
4655-TILE-20040	7314150387861	1	156
4655-WIDE-20040	7314150387830	1	156
4655-WING-C-250	7314150387854	1	156
4656-12-340	7314150386932	1	154
4656-12-540	7314150387021	1	154
4656-14-340	7314150387069	1	154
4656-14-540	7314150387076	1	154
4656-15-340	7314150387083	1	154
4656-16-1320	7314150387137	1	154
4656-16-340	7314150387106	1	154
4656-16-540	7314150387113	1	154



4656-16-940	7314150387120	1	154
4656-18-1320	7314150387175	1	154
4656-18-340	7314150387144	1	154
4656-18-540	7314150387151	1	154
4656-18-940	7314150387168	1	154
4656-20-1320	7314150387212	1	154
4656-20-320	7314150387182	1	154
4656-20-520	7314150387199	1	154
4656-20-920	7314150387205	1	154
4656-22-1320	7314150387250	1	154
4656-22-320	7314150387229	1	154
4656-22-520	7314150387236	1	154
4656-22-920	7314150387243	1	154
4656-24-320	7314150387267	1	154
4656-24-520	7314150387274	1	154
4656-25-1320	7314150387311	1	154
4656-25-320	7314150387281	1	154
4656-25-520	7314150387298	1	154
4656-25-920	7314150387304	1	154
4656-26-520	7314150387328	1	154
4656-28-370	7314150387434	1	154
4656-28-570	7314150387458	1	154
4656-28-670	7314150387489	1	154
4656-28-920	7314150387526	1	154
4656-30-370	7314150387540	1	154
4656-30-570	7314150387571	1	154
4656-32-1320	7314150387649	1	154
4656-32-370	7314150387595	1	154
4656-32-570	7314150387618	1	154
4656-32-920	7314150387632	1	154
4656-35-370	7314150387656	1	154
4656-35-570	7314150387663	1	154
4656-35-670	7314150387670	1	154
4656-37-370	7314150387687	1	154
4656-37-570	7314150387694	1	154
4656-37-920	7314150387700	1	154
4656-38-370	7314150387717	1	154
4656-38-570	7314150387724	1	154
4656-40-1320	7314150387762	1	154
4656-40-370	7314150387731	1	154
4656-40-570	7314150387748	1	154
4656-40-920	7314150387755	1	154
4656-45-570	7314150387779	1	154
4656-45-920	7314150387786	1	154
4656-50-570	7314150387793	1	154
4656-52-570	7314150387809	1	154
4659-FLAT -28	7314150387922	1	156
4659-FLAT -40	7314150387939	1	156
4659-FLAT -60	7314150387946	1	156
4659-POINT-28	7314150387892	1	156
4659-POINT-40	7314150387908	1	156
4659-POINT-60	7314150387915	1	156
4659-TILE-30-5	7314150388042	1	156
4659-TILE-30-8	7314150388059	1	156
4659-WIDE-30-8	7314150387953	1	156
4659-WIDE-36-5	7314150387984	1	156
466-1000	7314150128327	4	527
466-1000-M	7314150186105	4	527
466-1200	7314150128334	4	527
466-1200-M	7314150186129	4	527
466-1800	7314150128341	4	527
466-2000	7314150129836	4	527
466-250	7314150128655	10	529
466-400	7314150128297	4	527
466-400-M	7314150128358	4	527
466-600	7314150128303	4	527
466-600-M	7314150128365	4	527
466-800	7314150128310	4	527
466-800-M	7314150186082	4	527
466-BE-1	7314150215218	12	529
466-LINE	7314150215249	12	529
466-POST	7314150215232	6	529
4724-JT	7311518265847	1	621
4728-JT	7311518265854	1	621
474-125-0.60	7311518029050	10	537
474-125-0.80	7311518029869	10	537
474-150-0.60	7311518029876	10	537
474-150-0.80	7311518029883	10	537
4750-2PP-1	7314153014733	1	455
4750-3PB-1	7314153014719	1	454
4750-3PB-2	7314150187782	1	460
4750-BWC-1	7314153018809	1	456
4750-DHO-3	7314150289530	1	455
4750-EP-1	7314153014726	1	456
4750-FOLTC-1	7314153019271	1	454
4750-HDB-2	7314150289486	1	455
4750-HDBS-2	7314150289479	1	455
4750-HDLB-1	7314153014757	1	455
4750-HDLB-TAH	7314150303892	1	460
4750-HHO-2	7314153014863	1	460
4750-JU3PB-1	7314153015747	1	455
4750-KNHO-1	7314153015839	1	456
4750-KP-1	7314153014771	1	456
4750-LV-1	7314150358052	1	453
4750-LV-2	7314150393800	1	453
4750-MPH-1	7314150291625	1	456

* Until stocks last



4750-MTHO-TAH	7314150319589	1	460
4750-QRFB-1	7314150289455	1	455
4750-ROCO-1	7314153015273	1	456
4750-TOCST-1	7314153018779	1	454
4750-UP-2	7314150187768	1	460
4750-VDEC	7314150222377	1	454
4750-VMPH-1	7314153014818	1	456
4750ALC01FF1	7314150508884	1	429
4750BMC10	7314150264032	1	449
4750BMC10FF1	7314150500673	1	450
4750BMC3	7314150359639	1	449
4750BMC4	7314150426256	1	449
4750BMC5	7314150264001	1	449
4750BMC5.5	7314150326167	1	449
4750BMC7	7314150277605	1	449
4750BMC9	7314150264025	1	449
4750BMC11	7314150541294	1	127
4750FB1-19A	7314150277612	1	452
4750FB1-19B	7314150277629	4	452
4750FB2-19A	7314150277636	4	452
4750FB2-19TS001	7314150302772	1	450
4750FB2-24A	7314150277643	2	452
4750FB2W-24A	7314150277650	1	453
4750FB2W-TS001	7314150302765	1	450
4750FB3-12	7314150277667	1	453
4750FB4-18	7314150277674	4	453
4750FB4-18TS001	7314150302758	1	450
4750FB5-FG1	7314150401796	1	454
4750FB5-FG2	7314150401819	1	454
4750FB5A	7314150277704	1	453
4750FB5ATS001	7314150302727	1	451
4750FB5B	7314150277698	1	453
4750FB5BFF1	7314150302734	1	451
4750FB5C	7314150277681	8	453
4750FB6-13	7314150393091	1	453
4750FB6-19	7314150393114	1	453
4750FB7-01	7314150465668	60	454
4750FB7-02	7314150465675	60	454
4750FB7ORBG	7314150465682	120	455
4750FB7ORLT	7314150465699	120	455
4750FB8	7314150465651	4	452
4750PTB50	7314150275007	3	449
4750PTB60	7314150275014	3	449
4750PTB65	7314150345809	2	449
4750PTB65TS5	7314150456260	1	449
4750PTBW47	7314150275021	1	449
4750PTBW67	7314150289189	1	449
4750RC01	7314150220151	1	430
4750RCHD-AC1	7314150229857	1	431
4750RCHD00*	7314150271603	1	430
4750RCHD01*	7314150227426	1	430
4750RCHD011	7314150229802	1	430
4750RCHD01AC1	7314150229819	1	431
4750RCHD01AC2	7314150229826	1	431
4750RCHD01FF1	7314150247578	1	428
4750RCHD01FF2	7314150227433	1	430
4750RCHD01FF3	7314150229833	1	431
4750RCHD01FF4	7314150229840	1	431
4750RCHD01FF9	7314150247561	1	427
4750RCHD01RED	7314150249183	1	427
4750RCHD02	7314150249190	1	428
4750RCHD02FF1	7314150309580	1	428
4750RCHD02FF2	7314150345533	1	428
4750RCHD02FF3	7314150407538	1	430
4750RCHD02FF4	7314150227440	1	430
4750RCHD02FF5	7314150267422	1	426
4750RCHD02FF15	7314150347698	1	427
4750RCHD02FF2	7314150306787	1	426
4750RCHD02FF4	7314150309559	1	427
4750RCHD02RED	7314150407545	1	430
4750RCHD02RF1V	7314150422081	1	425
4750RCWD-AC1	7314150277179	1	430
4750RCWD-AC2	7314150277186	1	430
4750RCWD-AC3	7314150277193	1	431
4750RCWD-AC4	7314150277209	1	431
4750RCWD4	7314150277124	1	430
4750RCWD4FF1	7314150302413	1	425
479-08	7311518025441	6	579
479-12	7311518025458	6	579
479-16	7311518025465	6	579
479-20	7314150319862	6	579
479-24	7311518025472	6	579
479-32	7311518025489	6	579
479F-08	7314150441952	6	579
479F-12	7314150441976	6	579
479F-16	7314150441983	6	579
479F-20	7314150441990	6	579
479F-24	7314150442003	6	579
479F-32	7314150442010	6	579
480-08	7311518025496	4	580
480-10	7311518025502	6	580
480-12	7311518025519	6	580
480-14	7311518025526	6	580
480-20	7314150319763	4	580
481-100	7311518005030	6	579
481-1000	7311518005092	6	579



481-1500



481-1500	7311518025533	6	579
481-200	7311518005047	6	579
481-2000	7314150319855	6	579
481-300	7311518005054	6	579
481-400	7311518005061	6	579
481-500	7311518005078	6	579
481-800	7311518025540	6	579
481F-100	7314150442072	6	579
481F-1000	7314150442133	6	579
481F-1500	7314150442140	4	579
481F-200	7314150442089	4	579
481F-2000	7314150442157	4	579
481F-300	7314150442096	6	579
481F-400	7314150442102	6	579
481F-500	7314150442119	6	579
481F-800	7314150442126	6	579
482-25	7311518025557	6	579
482-28	7311518025564	6	579
482-30	7311518025571	6	579
482-35	7311518025595	6	579
482-40	7311518025601	6	579
482-45	7311518027551	6	579
482F-25	7314150442225	4	579
482F-28	7314150442232	4	579
482F-30	7314150442249	6	579
482F-35	7314150442256	4	579
482F-40	7314150442263	2	579
482F-45	7314150442270	4	579
483-16	7311518024314	6	580
483-20	7311518024321	6	580
483-22	7311518005108	6	580
483-25	7311518005115	6	580
483-28	7311518024284	6	580
4830	7314150100057	3	245
4831	7314150103393	3	245
4833	7314150100064	3	247
483F-16	7314150442164	6	580
483F-20	7314150442171	6	580
483F-22	7314150442188	6	580
483F-25	7314150442195	6	580
483F-28	7314150442201	6	580
483F-30	7314150442218	4	580
484-1000	7311518005122	6	580
484-1250	7311518005139	6	580
484-1500	7311518005146	6	580
484-2000	7311518024338	4	580
484F-1000	7314150442027	6	580
484F-1250	7314150442034	6	580
484F-1500	7314150442041	6	580
484F-2000	7314150442058	4	580
485	7311518005153	6	580
485W-650	7314150319770	6	580
485W-750	7314150319787	6	580
486	7311518005160	4	581
486-1800	7314150315307	5	529
486-1800WH	7314150315338	5	529
486-2000	7314150315314	5	529
486-2000WH	7314150315345	5	529
486-2400	7314150315321	5	529
486-2400WH	7314150315352	5	529
486-700*	7314150338078	6	581
486F-700*	7314150338085	6	581
486W-500	7314150319794	4	581
486W-600	7314150319800	4	581
488-2000	7314150337972	2	581
488-3000	7314150337989	2	581
488-4000	7314150337996	2	581
488-5000	7314150338009	2	581
488-6000	7314150338016	1	581
488F-2000	7314150338023	2	581
488F-3000	7314150338030	2	581
488F-4000	7314150338047	2	581
488F-5000	7314150338054	4	581
488F-6000	7314150338061	2	581
489-1100	7314150133055	8	583
489-1800	7314150133062	8	583
489-2700	7314150133079	4	583
489-3600	7314150133086	4	583
489-4500	7314150133093	4	583
489-5400	7314150133109	4	583
490-3.5*	7311518025373	4	580
491-3000	7314150345199	4	583
491-4000	7314150345205	4	583
491-5000	7314150345212	4	583
491-6000	7314150345229	4	583
492-3.5*	7311518025380	6	580
493-500*	7314150338139	6	582
493-600*	7314150338146	6	582
493F-500*	7314150338153	6	582
493F-600*	7314150338160	1	582
494-600	7311518025397	6	582
495-500*	7314150338191	6	582
495-600*	7314150338207	6	582
495F-500*	7314150338184	6	582
495F-600*	7314150338177	1	582
496-1500	7314150315147	5	529



496-1800	7314150315154	5	529
496-SPARE	7314150329304	1	530
4M-10-11	7314151829438	10	55
4M-12-13	7314151829445	10	55
4M-14-15	7314151829476	10	55
4M-16-17	7314151829490	10	55
4M-17-19	7314151829506	10	55
4M-18-19	7314151829513	10	55
4M-20-22	7314151829520	10	55
4M-21-23	7314150205363	5	55
4M-24-26	7314150205370	1	55
4M-24-27	7314151829551	1	55
4M-25-28	7314150205387	1	55
4M-27-29	7314150205394	1	55
4M-30-32	7314151829575	1	55
4M-6-7	7314151829407	10	55
4M-8-9	7314151829414	10	55
4M/10C	7314150212972	1	55
4M/10T	7314151829605	1	55
4M/12C	7314150212989	1	56
4M/8	7314150180493	1	36
5-600-21-D-1P	7311518189341	10	36
5-610-21-D-1P	7311518189358	5	36
5-630-21-D-1P	7311518189365	1	36
5-670-21-D-1P*	7311518189389	1	36
500-12	7314150390977	1	274
500-14	7314150414505	1	274
500-15	7314150390984	1	274
500-16	7314150414512	1	274
500-18	7314150414543	1	274
500-22	7314150414567	1	274
502	7311518130589	25	554
502-SET2	7311518130664	35	554
502-SET6	7311518130633	10	554
5050	7314151083359	1	354
51-12	7311518044565	10	619
51-21	7311518003906	10	619
51-24	7311518003913	10	619
51-30	7311518003920	10	619
51-32	7311518003937	10	619
51-36	7311518003944	10	619
510031	7314150216338	5	221
510033	7314150216345	5	221
510034	7314150216314	10	221
5124-JS-H	7311518219352	4	620
5128-JS-H	7311518219369	4	620
52	7311518276027	12	304
5226 DC*	7314150120352	1	252
527 D-160	7314150032723	5	240
527 D-200	7314150032730	5	240
527 GC-160	7314150205653	3	240
527 GC-200	7314150205660	3	240
527V-160	7314150126811	2	487
527V-200	7314150126828	2	487
528-700	7311518188993	1	561
528-COM	7311518188986	1	561
529-16-L	7314150198139	4	578
529-16-XL	7314150198146	4	578
529-20-L	7314150198160	4	578
529-20-XL*	7314150198153	4	578
529S-16-XL	7314150340330	4	578
529S-20-XL	7314150340347	4	578
541 D-150	7314150032754	5	240
541 D-200	7314150032761	5	240
541 D-250	7314150032778	5	240
5418	7314151084370	1	523
5419/6T	7314151821562	1	523
541D-180	7314150127160	5	240
541D-225	7314150127290	5	240
5463 R	7314151085063	5	522
5463-120	7314151085001	5	522
54640	7314150215720	1	176
5465 AMT	7314151085148	5	520
5468-112	7314151085247	5	520
5469 B	7314151085322	5	520
5469 BI	7314151085346	5	520
5469 I	7314151085407	5	520
5469 R	7314151085421	5	520
5469-127	7314151085285	5	520
5471 F-120	7314151085681	5	520
5471 F-145	7314151085704	5	520
5471 F-200	7314151085728	5	520
5471 F-250	7314151085742	5	520
5471 F-300	7314151085766	5	520
5471 FI-120	7314151085780	5	520
5471 FI-200	7314151085827	5	520
5471 FR-120	7314151085889	5	520
5471 FR-145	7314151085902	5	520
5475 K	7314151086244	5	520
5475 R	7314151086268	5	520
5476 H	7314151086305	5	522
5488 AM	7314151821166	5	521
5490 AM	7314151821180	5	521
5493-115	7314151821234	5	522
5515B	7314151086978	25	354
5515FL	7314150504077	10	354



5515FUV	7314150540143	1	354
5515GV	7314151481483	1	354
5515L	7314151481568	1	355
5515M	7314151086985	1	355
5515T	7314151589172	25	355
5515T-52	73141553021939	25	354
5516	7314151086992	5	520
5516 I	7314151087029	5	520
5517	7314151573843	5	520
5517 I	7314151573928	5	520
5518	7314151087043	5	520
5521	7314150215713	1	176
5540 AM	7314151821319	5	520
5541 AM	7314151821326	5	520
5544 AM	7314151821357	5	521
5545 AM	7314151821364	5	521
5546 AM	7314151821371	5	521
5547 AM	7314151821388	5	521
5549 AM	7314151821401	5	521
5550-3.2	7314151475673	10	523
5550-4.5	7314151475758	10	523
5552*	7314151378554	1	523
5553*	7314151378639	1	523
5554*	7314151378714	1	523
5578-115	7314151547769	5	521
5579-115	7314151547844	5	521
5588 AM	7314151821432	5	521
5589 AM	7314151821449	5	521
5590 AM	7314151821456	5	521
5600/4*	7314151436773	1	524
5724-JS	7311518216085	1	621
5728-JS	7311518216092	1	621
5750	7311518280949	1	338
5770	7314150504466	12	338
59/S100BC	7314150337637	1	174
59/S100BC-IP	7314150337644	8	174
59/S10BC	7314150413003	1	172
59/S28-4	7314151847173	1	173
59/S31B	7314150325788	6	173
59/S31B-IP	7314150325795	12	173
59/S35BC	7314150412990	1	174
59/S36BCR	7314150413232	6	217
59/S54BC	7314150337613	20	174
59/S54BC-IP	7314150337620	8	174
59S/0.5-3.0-3P	7314150259205	50	167
59S/0.5-4.0	7314150199822	1	167
59S/0.5-4.0-3P	7314150259212	50	167
59S/0.6-3.5	7314150199839	1	167
59S/0.6-3.5-3P	7314150259229	50	167
59S/0.6-4.5	73141501998801	1	167
59S/0.6-4.5-3P	7314150201600	1	167
59S/0.8-5.5	73141501998849	1	167
59S/0.8-5.5-3P	7314150201624	1	167
59S/1.0-5.5	73141501998863	1	167
59S/1.0-5.5-3P	7314150259963	50	167
59S/1.2-6.5	73141501998887	1	167
59S/1.2-6.5-3P	7314150258970	50	167
59S/1.2-8.0	73141501998900	1	167
59S/1.2-8.0-3P	7314150258987	1	167
59S/1.6-10	73141501998846	1	167
59S/1.6-10-3P	7314150259236	50	167
59S/1.6-9.0	73141501998853	1	167
59S/1.6-9.0-3P	7314150259243	50	167
59S/125PH1-2P	7314150260553	25	171
59S/125PH2-2P	7314150260560	25	171
59S/125PH2-IP	7314150342433	100	171
59S/125PH2COMBI-2P	7314150531530	40	171
59S/125PH3	7314150204304	1	171
59S/125PH3-2P	7314150260577	25	171
59S/125PZ1	7314150200733	1	171
59S/125PZ1-2P	7314150260522	25	171
59S/125PZ2	7314150200740	1	171
59S/125PZ2-2P	7314150260539	25	171
59S/125PZ3	7314150200757	1	171
59S/125PZ3-2P	7314150260546	25	171
59S/150T15	7314150200764	1	171
59S/150T15-2P	7314150260584	1	171
59S/150T20-2P	7314150260591	1	171
59S/150T25-2P	7314150260607	1	171
59S/150T30-2P	7314150260614	1	171
59S/17-1	7314150191499	1	172
59S/17-2	7314150191505	1	173
59S/17-3*	7314150191512	1	173
59S/22-1	7314150204229	12	173
59S/22-2	7314150204236	12	173
59S/31-1	7314150191451	12	174
59S/31-2	7314150191468	1	174
59S/50/0.6-3.5-5P	7314150531554	50	169
59S/50/0.8-4.0-5P	7314150531578	50	169
59S/50/0.8-5.5-5P	7314150531592	50	169
59S/50/1.0-6.0-5P	7314150531615	50	169
59S/50/1.2-6.5-5P	7314150531639	50	169
59S/50/3.5-2P	7314150260027	50	169
59S/50/4.0-2P	7314150260041	50	169
59S/50/5.5-2P	7314150260065	50	169
59S/50/6.0-2P	7314150260089	1	169

* Until stocks last



59S/50/6.5-2P	7314150260102	50	169
59S/50H1/16	7314150248926	1	170
59S/50H1/4	7314150249015	1	170
59S/50H1/8	7314150248964	1	170
59S/50H2	7314150200160	1	170
59S/50H2-2P	7314150259298	50	170
59S/50H2.5-2P	7314150259304	50	170
59S/50H2.5-5P	7314150531653	50	170
59S/50H3-2P	7314150259335	50	170
59S/50H3-5P	7314150531677	50	170
59S/50H3/16	7314150248995	1	170
59S/50H3/32	7314150248940	1	170
59S/50H3/8	7314150249039	1	170
59S/50H4-2P	7314150259359	50	170
59S/50H4-5P	7314150531691	50	170
59S/50H5-2P	7314150259373	50	170
59S/50H5-5P	7314150531714	50	170
59S/50H5/16	7314150249022	1	170
59S/50H5/32	7314150248988	1	170
59S/50H5/64	7314150248933	1	170
59S/50H6-2P	7314150259397	50	170
59S/50H6-5P	7314150531738	50	170
59S/50H7/32	7314150249008	1	170
59S/50H7/64	7314150248957	1	170
59S/50H8-2P	7314150259410	50	170
59S/50H8-5P	7314150531752	50	170
59S/50PH1-2P	7314150203642	1	169
59S/50PH1-5P	7314150531776	50	169
59S/50PH2-2P	7314150203758	1	169
59S/50PH2-5P	7314150531790	50	169
59S/50PH3-2P	7314150203802	1	169
59S/50PH3-5P	7314150531813	50	169
59S/50PZ1-2P	7314150204007	1	170
59S/50PZ1-5P	7314150531837	50	170
59S/50PZ2-2P	7314150204014	1	170
59S/50PZ2-5P	7314150531851	50	170
59S/50PZ3-2P	7314150204021	1	170
59S/50PZ3-5P	7314150531875	50	170
59S/50R1	7314150200238	1	170
59S/50R1-2P	7314150259441	50	170
59S/50R2	7314150200245	1	170
59S/50R2-2P	7314150259472	50	170
59S/50R3	7314150200252	1	170
59S/50R3-2P	7314150259502	50	170
59S/50T10-2P	7314150201723	1	170
59S/50T10-5P	7314150531899	50	170
59S/50T15-2P	7314150201730	1	170
59S/50T15-5P	7314150531912	50	170
59S/50T20-2P	7314150201747	1	170
59S/50T20-5P	7314150531936	50	170
59S/50T25-2P	7314150201754	1	170
59S/50T25-5P	7314150531950	50	170
59S/50T27	7314150200139	1	170
59S/50T30-2P	7314150201761	1	170
59S/50T30-5P	7314150531974	50	170
59S/50T40-2P	7314150259281	50	170
59S/50T40-5P	7314150531998	50	170
59S/50T8	7314150200085	1	170
59S/50T8-2P	7314150262809	50	170
59S/60PEN/DISP*	7314150459032	1	175
59S/7-1*	7314150191536	1	172
59S/7-2	7314150191543	1	172
59S/7-3	7314150191550	1	172
59S/7-4	7314150191567	1	172
59S/70PH1-2P	7314150259526	1	170
59S/70PH1-5P	7314150532018	25	170
59S/70PH2-2P	7314150259557	25	170
59S/70PH2-5P	7314150532032	25	170
59S/70PZ1-2P	7314150259564	1	170
59S/70PZ1-5P	7314150532056	25	170
59S/70PZ2-2P	7314150260331	1	170
59S/70PZ2-5P	7314150532070	25	170
59S/70PZ3	7314150200306	1	170
59S/70PZ3-2P	7314150260348	1	170
59S/70T10-2P	7314150260355	1	171
59S/70T10-5P	7314150532094	25	171
59S/70T15-2P	7314150260362	25	171
59S/70T15-5P	7314150532117	25	171
59S/70T20-2P	7314150201839	25	171
59S/70T20-5P	7314150532131	25	171
59S/70T25-2P	7314150260379	25	171
59S/70T25-5P	7314150532155	25	171
59S/70T27	7314150200597	1	171
59S/70T27-2P	7314150260386	1	171
59S/70T30-2P	7314150260393	1	171
59S/70T30-5P	7314150532179	25	171
59S/70T40-2P	7314150260409	1	171
59S/70T40-5P	7314150532193	25	171
59S/70TR15	7314150200627	1	171
59S/70TR15-2P	7314150260416	1	171
59S/70TR20	7314150200634	1	171
59S/70TR20-2P	7314150260423	25	171
59S/70TR25	7314150200641	1	171
59S/70TR25-2P	7314150260430	25	171
59S/70TR27	7314150200658	1	171
59S/70TR27-2P	7314150260447	25	171



59S/70TR30



59S/70TR30	7314150200665	1	171
59S/70TR30-2P	7314150260454	25	171
59S/70TR40	7314150200672	1	171
59S/70TR40-2P	7314150260461	25	171
59S/H1.5-3P	7314150258994	50	168
59S/H1.5-5P	7314150532216	50	168
59S/H1/16-3P	7314150259021	50	169
59S/H1/16-5P	7314150532230	50	169
59S/H1/4	7314150199266	1	169
59S/H1/4-3P	7314150259120	50	169
59S/H1/8-3P	7314150259069	50	169
59S/H1/8-5P	7314150532254	50	169
59S/H10-3P	7311518333638	25	168
59S/H10-5P	7314150532278	50	168
59S/H2	7314150198955	1	168
59S/H2-3P	7314150259007	50	168
59S/H2.5-3P	7314150259014	50	168
59S/H2.5-5P	7314150532315	50	168
59S/H3-3P	7314150201662	1	168
59S/H3-5P	7314150532339	50	168
59S/H3/16-5P	7314150532353	50	169
59S/H3/32-3P	7314150259045	50	169
59S/H3/32-5P	7314150532377	50	169
59S/H3/8	7314150204212	1	169
59S/H3/8-3P	7314150259144	25	169
59S/H3BALL	7314150200689	1	171
59S/H3BALL-2P	7314150260478	1	171
59S/H4-3P	7314150201679	1	168
59S/H4-5P	7314150532391	50	168
59S/H4-IPB	7314150225767	500	168
59S/H4BALL-2P	7314150260485	1	171
59S/H5-3P	7314150201686	1	168
59S/H5-5P	7314150532414	50	168
59S/H5/16-3P	7314150259137	50	169
59S/H5/16-5P	7314150532438	50	169
59S/H5/32-3P	7314150259083	50	169
59S/H5/32-5P	7314150532452	50	169
59S/H5/64-3P	7314150259038	50	169
59S/H5/64-5P	7314150532476	50	169
59S/H5BALL	7314150200702	1	171
59S/H5BALL-2P	7314150260492	1	171
59S/H6-3P	7314150201693	1	168
59S/H6-5P	7314150532490	50	168
59S/H6BALL	7314150200719	1	171
59S/H6BALL-2P	7314150260508	1	171
59S/H7/32-3P	7314150259113	50	169
59S/H7/32-5P	7314150532513	50	169
59S/H7/64-3P	7314150259052	50	169
59S/H7/64-5P	7314150532537	50	169
59S/H8-3P	7314150201709	1	168
59S/H8-5P	7314150532551	50	168
59S/H8BALL	7314150200726	1	171
59S/H8BALL-2P	7314150260515	1	171
59S/HBALL-3P	7314150201716	1	171
59S/M3	7314150199730	1	169
59S/M3-3P	7314150259151	50	169
59S/M4	7314150199754	1	169
59S/M4-3P	7314150259168	50	169
59S/M5	7314150199778	1	169
59S/M5-3P	7314150259175	50	169
59S/M6	7314150199792	1	169
59S/M6-3P	7314150259182	50	169
59S/M8	7314150199808	1	169
59S/M8-3P	7314150259199	50	169
59S/PH0	7314150198177	1	167
59S/PH0-3P	7314150258819	50	167
59S/PH1-10P	7314150532575	50	167
59S/PH1-30P	7314150200801	1	167
59S/PH1-3P	7314150201396	1	167
59S/PH1-IP	7314150206780	100	167
59S/PH1-IPB	7314150225743	500	167
59S/PH1COMBI-2P	7314150215669	1	171
59S/PH2-10P	7314150532599	50	167
59S/PH2-30P	7314150200818	1	167
59S/PH2-3P	7314150201402	1	167
59S/PH2-IP	7314150206797	100	167
59S/PH2-IPB	7314150204038	500	167
59S/PH2G-10P	7314150532612	50	168
59S/PH2G-30P	7314150200832	1	168
59S/PH2G-3P	7314150259250	50	168
59S/PH2PEN*	7314150458950	10	175
59S/PH3-10P	7314150532636	50	167
59S/PH3-30P	7314150200825	1	167
59S/PH3-3P	7314150201419	1	167
59S/PH3-IPB	7314150225750	500	167
59S/PH3COMBI-2P	7314150203611	1	171
59S/PH4	7314150198368	1	167
59S/PH4-3P	7314150258826	25	167
59S/PZ0-3P	7314150258833	50	168
59S/PZ1-10P	7314150532650	50	168
59S/PZ1-30P	7314150200849	1	168
59S/PZ1-3P	7314150201426	1	168
59S/PZ1-IP	7314150206803	100	168
59S/PZ1-IPB	7314150204373	500	168
59S/PZ2-10P	7314150532674	50	168
59S/PZ2-30P	7314150200856	1	168



59S/PZ2-3P	7314150201433	1	168
59S/PZ2-IP	7314150206810	100	168
59S/PZ2-IPB	7314150204380	500	168
59S/PZ2PEN*	7314150458974	10	175
59S/PZ3-10P	7314150532698	50	168
59S/PZ3-30P	7314150200863	1	168
59S/PZ3-3P	7314150201440	1	168
59S/PZ3-IPB	7314150225736	500	168
59S/PZ4	7314150198436	1	168
59S/R1	7314150199310	1	169
59S/R1-3P	7314150201631	1	169
59S/R2-3P	7314150201648	1	169
59S/R3	7314150199365	1	169
59S/R3-3P	7314150201655	1	169
59S/R4	7314150232109	1	169
59S/T10-10P	7314150532711	50	168
59S/T10-30P	7314150200870	1	168
59S/T10-3P	7314150201457	1	168
59S/T10CS	7314150444014	20	168
59S/T15-10P	7314150532759	50	168
59S/T15-30P	7314150200887	1	168
59S/T15-3P	7314150201464	1	168
59S/T15CS	7314150444021	20	168
59S/T15PEN*	7314150458929	10	175
59S/T20-10P	7314150532797	50	168
59S/T20-30P	7314150200894	1	168
59S/T20-3P	7314150201471	1	168
59S/T20CS	7314150444038	20	168
59S/T20PEN*	7314150458936	10	175
59S/T25-10P	7314150532834	50	168
59S/T25-30P	7314150200900	1	168
59S/T25-3P	7314150201488	1	168
59S/T25CS-10P	7314150532858	50	168
59S/T25PEN*	7314150458943	10	175
59S/T27-10P	7314150532872	50	168
59S/T27-3P	7314150201495	1	168
59S/T27CS	7314150444052	20	168
59S/T3	7314150198443	1	168
59S/T3-3P	7314150258840	50	168
59S/T30-10P	7314150251988	50	168
59S/T30-30P	7314150200924	1	168
59S/T30-3P	7314150201501	1	168
59S/T30CS	7314150444069	20	168
59S/T4-3P	7314150258857	50	168
59S/T40-10P	7314150532933	50	168
59S/T40-30P	7314150200931	1	168
59S/T40-3P	7314150201518	1	168
59S/T40CS	7314150444076	20	168
59S/T45-3P	7314150258918	50	168
59S/T45-5P	7314150532971	50	168
59S/T5	7314150198467	1	168
59S/T5-3P	7314150258864	50	168
59S/T50-3P	7314150258925	50	168
59S/T50-5P	7314150532995	50	168
59S/T6-3P	7314150258871	50	168
59S/T7	7314150198498	1	168
59S/T7-3P	7314150258888	50	168
59S/T8	7314150198504	1	168
59S/T8-3P	7314150258895	50	168
59S/T9	7314150198511	1	168
59S/T9-3P	7314150258901	50	168
59S/TCS11-1	7314150444083	10	172
59S/TR10-3P	7314150201525	1	168
59S/TR10-5P	7314150533015	50	168
59S/TR15	7314150198719	1	168
59S/TR15-3P	7314150201532	1	168
59S/TR20-3P	7314150201549	1	168
59S/TR20-5P	7314150533053	50	168
59S/TR25-3P	7314150201556	1	168
59S/TR25-5P	7314150533077	50	168
59S/TR27	7314150198757	1	168
59S/TR27-3P	7314150201570	1	168
59S/TR30-3P	7314150201587	1	168
59S/TR30-5P	7314150533091	50	168
59S/TR40	7314150198795	1	168
59S/TR40-3P	7314150201594	1	168
59S/TR7	7314150198672	1	168
59S/TR7-3P	7314150258932	50	168
59S/TR8	7314150198689	1	168
59S/TR8-3P	7314150258949	50	168
59S/TR9	7314150198696	1	168
59S/TR9-3P	7314150258956	50	168
59S/TS-0	7314150199389	1	169
59S/TS-1	7314150199396	1	169
59S/TS-10-5P	7314150533138	50	169
59S/TS-4-5P	7314150533152	50	169
59S/TS-5-5P	7314150533176	50	169
59S/TS-6-5P	7314150533190	50	169
59S/TS-8-5P	7314150533220	50	169
59S/TW0	7314150199617	1	169
59S/TW1	7314150199631	1	169
59S/TW2	7314150199655	1	169
59S/TW3	7314150199679	1	169
59S/TW4	7314150199693	1	169
59S/TW5	7314150199716	1	169
6	8412814220048	1	225

Part Number	Part Number	Quantity	Quantity
6-342-06-2-0	7311518021719	10	32
6-342-06-2-2	7311518244170	5	32
6-342-08-1-0	7311518021726	10	32
6-342-08-1-2	7311518028282	5	32
6-342-08-2-0	7311518021733	10	32
6-342-08-2-2	7311518005375	5	32
6-342-10-1-0	7311518021757	10	32
6-342-10-1-2	7311518005382	5	32
6-342-10-2-0	7311518021764	10	32
6-342-10-2-2	7311518005399	5	32
6-343-08-2-0	7311518021801	10	32
6-343-08-2-2	7311518001070	5	32
6-343-08-3-0	7311518021818	10	32
6-343-10-2-0	7311518021825	10	32
6-343-10-2-2	7311518001094	5	32
6-343-10-3-0	7311518021832	10	32
6-344-08-2-0	7311518021887	10	32
6-344-08-2-2	7311518005344	5	32
6-344-10-2-0	7311518021900	10	32
6-344-10-2-2	7311518005351	5	32
6-345-08-1-2	7311518028312	5	33
6-345-08-2-0	7311518021948	10	32
6-345-08-2-2	7311518005412	5	33
6-345-10-1-2	7311518005429	5	33
6-345-10-2-0	7311518021955	10	32
6-470-08-2-2	7311518242008	5	33
600-3	7314150124787	1	214
600.003.010	8412814600000	1	366
600.005.012	8412814600017	1	366
601000800	8413345202299	1	575
601001000	8413345202305	1	575
601001250	8413345202312	1	575
601001500	8413345202329	1	575
6010H0800	8413345015769	1	576
6010H1000	8413345015776	1	576
6010H1250	8413345015783	1	576
6010H1500	8413345015790	1	576
6010M0800	8413345015806	1	575
6010M1000	8413345116619	1	575
6010M1250	8413345015820	1	575
6010M1500	8413345015837	1	575
602-4-LA	7314150224357	1	214
604-5	7314150124800	1	214
6040M0630	8413345124126	1	576
605-10-PC-AU	7314150186334	1	216
605-6	7314150153770	1	215
606-6	7314150124824	1	215
6070H1000	8413345030656	1	575
6070H1250	8413345084833	1	575
6070H1500	8413345030663	1	575
6070H1750	8413345030670	1	575
607201000	8413345030533	1	575
607201250	8413345030540	1	575
607201500	8413345030557	1	575
607201750	8413345030564	1	575
6072M1000	8413345015813	1	575
6072M1500	8413345137454	1	575
6072M1750	8413345030687	1	575
60T/17-1	7314150191529	1	164
60T/7-1	7314150191574	1	164
60T/PH1	7314150199488	1	163
60T/PH2	7314150199495	1	163
60T/PH3	7314150199501	1	163
60T/PZ3	7314150199563	1	164
60T/T15	7314150199662	1	164
60T/T20	7314150199686	1	164
60T/T25	7314150199709	1	164
60T/T27	7314150199723	1	164
60T/T40	7314150199761	1	164
60T/T7	7314150199587	1	164
60T/T9	7314150199624	1	164
610-6	7314150124848	1	215
611-10-200	7314150124428	10	216
611-3.5-100	7314150124336	10	216
611-3.5-75	7314150124329	10	216
611-4-100	7314150124350	10	216
611-4-75	7314150124343	10	216
611-5.5-100	7314150124367	10	216
611-5.5-125	7314150124381	10	216
611-6.5-125	7314150124374	10	216
611-6.5-150	7314150124398	10	216
611-6.5-25	7314150124602	10	216
611-8-150	7314150124404	10	216
611-8-175	7314150124411	10	216
612-5	7314150124817	1	215
613-3-100	7314150124442	10	216
613-3-75	7314150124435	10	216
613-3.5-100	7314150124459	10	216
613-4-100	7314150124466	10	216
613-4-125	7314150124473	10	216
613-5.5-150	7314150124497	10	216
613-6.5-150	7314150124503	10	216
615-0-75	7314150124558	10	216
615-1-100	7314150124565	10	216
615-2-125	7314150124572	10	216
615-2-25	7314150124596	10	216

* Until stocks last

Part Number	Part Number	Quantity	Quantity
615-3-150	7314150124589	10	216
6151	7314150539185	10	628
6152	7314150539192	10	628
6152SS	7314150539215	10	628
6159	7314150539208	10	628
616-0-75	7314150124510	10	216
616-1-100	7314150124527	10	216
616-2-125	7314150124534	10	216
616-3-150	7314150124541	10	216
618-10-75	7314150124619	10	217
618-15-100	7314150124626	10	217
618-20-100	7314150124633	10	217
618-25-125	7314150124640	10	217
618-27-125	7314150124657	10	217
618-30-150	7314150124664	10	217
618-40-150	7314150124671	10	217
61H/50PH1	7314150200382	1	164
61H/50PZ1	7314150200412	1	164
61H/50PZ3	7314150200436	1	164
61H/50T10	7314150200443	1	164
61H/50T15	7314150200450	1	164
61H/50T25	7314150200474	1	164
61H/PH2	7314150199020	1	164
61H/PH3	7314150199044	1	164
61H/PZ3	7314150199105	1	164
61H/T10	7314150199129	1	165
61H/T15	7314150199143	1	165
61H/T20	7314150199167	1	165
61H/T25	7314150199181	1	165
61H/T40	7314150199235	1	165
620-6	7314150128594	1	485
622-3P	7314150427727	1	252
6221D	7314150421596	10	251
6221D IP	7314150440368	10	251
6222D	7314150421589	10	251
6222D IP	7314150437702	10	251
6223D	7314150421558	8	251
6223D IP	7314150421794	8	251
6224	7314150421619	4	251
6224D	7314150421565	5	251
6224D IP	7314150421800	5	251
6225D	7314150421572	10	251
6225D IP	7314150421817	5	251
623-3-100	7314150128518	10	485
623-3.5-100	7314150128525	10	485
623-4-100	7314150128532	10	485
623-5.5-125	7314150128549	10	485
623-6.5-150	7314150128556	10	485
625	7311518221614	5	536
625-0-100	7314150128563	10	485
625-1-150	7314150128570	10	485
625-2-175	7314150128587	10	485
625-DROP	7311518221638	10	536
625-PEAR	7311518221621	10	536
625-ROUND	7311518221645	10	536
6258	7314150539222	10	628
62TIN/50PH1	7314150200504	1	163
62TIN/50PH3	7314150200528	1	163
62TIN/50PZ1	7314150200535	1	163
62TIN/50PZ2	7314150200542	1	163
62TIN/50PZ3	7314150200559	1	163
62TIN/7-1	7314150203505	1	163
62TIN/PH1	7314150199259	1	163
62TIN/PZ1	7314150199327	1	163
62TIN/PZ2	7314150199334	1	163
62TIN/PZ3	7314150199358	1	163
62TIN/T15	7314150199402	1	163
62TIN/T20	7314150199426	1	163
62TIN/T25	7314150199440	1	163
62TIN/T30	7314150199464	1	163
63D/50PZ1	7314150200320	1	162
63D/50PZ2	7314150200337	1	162
63D/50PZ3	7314150200344	1	162
63D/7-1	7314150191604	1	162
63D/PH3	7314150198948	1	162
63D/PZ1	7314150198856	1	162
63D/PZ2	7314150198870	1	162
63D/T10	7314150198665	1	162
63D/T15	7314150198733	1	162
63D/T40	7314150198832	1	162
64A/PH1	7314150198481	1	163
64A/PH3	7314150198573	1	163
64A/PZ1	7314150198603	1	163
64A/PZ3	7314150198634	1	163
650	7311518221591	5	536
65I/7-1*	7314150204113	1	517
65I/PH1*	7314150199785	1	517
65I/PH1-2P*	7314150207985	1	517
65I/PH2-2P*	7314150201259	1	517
65I/PH3*	7314150199907	1	517
65I/PH3-2P*	7314150201266	1	517
65I/PZ1*	7314150199921	1	517
65I/PZ1-2P*	7314150201273	1	517
65I/PZ2-2P*	7314150201280	1	517
65I/PZ3*	7314150199969	1	517
65I/PZ3-2P*	7314150201297	1	517





65I/T15*	7314150199990	1	517
65I/T40*	7314150200078	1	517
65I/T40-2P*	7314150201358	1	517
665	7311518221607	5	536
66IM/10C-1	7314150450732	40	167
66IM/11C-1	7314150450718	40	167
66IM/150PH2-2P	7314150550173	40	166
66IM/150PZ2-2P	7314150550197	40	166
66IM/150T20C-2P	7314150550210	40	166
66IM/150T25C-2P	7314150550234	40	166
66IM/150T30C-2P	7314150550258	40	166
66IM/150T40C-2P	7314150550272	40	166
66IM/31C-1	7314150528158	6	167
66IM/40C-1	7314150548385	10	167
66IM/50PH1-10P	7314150550470	50	165
66IM/50PH1-2P	7314150446056	80	165
66IM/50PH2-10P	7314150550494	50	165
66IM/50PH2-2P	7314150446063	80	165
66IM/50PH3-10P	7314150550517	50	165
66IM/50PH3-2P	7314150446087	80	165
66IM/50PZ1-10P	7314150550531	50	165
66IM/50PZ1-2P	7314150446094	80	165
66IM/50PZ2-10P	7314150550555	50	165
66IM/50PZ2-2P	7314150446100	80	165
66IM/50PZ3-10P	7314150550579	50	165
66IM/50PZ3-2P	7314150446117	80	165
66IM/50T10C-10P	7314150550593	50	165
66IM/50T10C-2P	7314150446131	80	165
66IM/50T15C-10P	7314150550616	50	165
66IM/50T15C-2P	7314150446148	80	165
66IM/50T20C-10P	7314150550630	50	165
66IM/50T20C-2P	7314150446155	80	165
66IM/50T25C-10P	7314150550654	50	165
66IM/50T25C-2P	7314150446162	80	165
66IM/50T27C-10P	7314150550678	50	165
66IM/50T27C-2P	7314150446179	80	165
66IM/50T30C-10P	7314150550692	50	165
66IM/50T30C-2P	7314150446186	80	165
66IM/50T40C-10P	7314150550715	50	165
66IM/50T40C-2P	7314150446193	80	165
66IM/90PH2-2P	7314150550296	40	166
66IM/90PH3-2P	7314150550319	40	166
66IM/90PZ2-2P	7314150550333	40	166
66IM/90PZ3-2P	7314150550357	40	166
66IM/90T15C-2P	7314150550371	40	166
66IM/90T20C-2P	7314150550395	40	166
66IM/90T25C-2P	7314150550418	40	166
66IM/90T30C-2P	7314150550432	40	166
66IM/90T40C-2P	7314150550456	40	166
66IM/K50-1/2-1P	7314150549917	20	167
66IM/K50-1/4-1P	7314150549931	20	167
66IM/K50-3/8-1P	7314150549955	20	167
66IM/KM150-1P	7314150549979	20	166
66IM/KM300-1P	7314150549993	20	166
66IM/KM75-1P	7314150550012	20	166
66IM/KM75QR-1P	7314150550036	20	166
66IM/M50-10-1P	7314150550050	20	166
66IM/M50-11-1P	7314150550074	20	166
66IM/M50-13-1P	7314150550098	20	166
66IM/M50-6-1P	7314150550111	20	166
66IM/M50-7-1P	7314150550135	20	166
66IM/M50-8-1P	7314150550159	20	166
66IM/PH1-10P	7314150550739	50	165
66IM/PH1-2P	7314150445929	80	165
66IM/PH2-10P	7314150550753	50	165
66IM/PH2-25P	7314150550777	25	165
66IM/PH2-2P	7314150445936	80	165
66IM/PH3-10P	7314150550791	50	165
66IM/PH3-2P	7314150445943	80	165
66IM/PZ1-10P	7314150550814	50	165
66IM/PZ1-2P	7314150445950	80	165
66IM/PZ2-10P	7314150550838	50	165
66IM/PZ2-25P	7314150550852	25	165
66IM/PZ2-2P	7314150445967	80	165
66IM/PZ3-10P	7314150550876	50	165
66IM/PZ3-2P	7314150445974	80	165
66IM/T10C-10P	7314150550913	50	165
66IM/T10C-2P	7314150445981	80	165
66IM/T15C-10P	7314150550937	50	165
66IM/T15C-2P	7314150445998	80	165
66IM/T20C-10P	7314150550951	50	165
66IM/T20C-25P	7314150550975	25	165
66IM/T20C-2P	7314150446001	80	165
66IM/T25C-10P	7314150550999	50	165
66IM/T25C-25P	7314150551019	25	165
66IM/T25C-2P	7314150446018	80	165
66IM/T27C-10P	7314150551033	50	165
66IM/T27C-2P	7314150446025	80	165
66IM/T30C-10P	7314150551057	50	165
66IM/T30C-25P	7314150551071	25	165
66IM/T30C-2P	7314150446032	80	165
66IM/T40C-10P	7314150550890	50	165
66IM/T40C-2P	7314150446049	80	165
6700SM-10	7314151088026	5	81
6700SM-11	7314151088033	5	81
6700SM-12	7314151088040	5	81



6700SM-13	7314151088057	5	81
6700SM-14	7314151088064	5	81
6700SM-4	7314151087944	5	81
6700SM-4.5	7314151087951	5	81
6700SM-5	7314151087968	5	81
6700SM-5.5	7314151087975	5	81
6700SM-6	7314151087982	5	81
6700SM-7	7314151087999	5	81
6700SM-8	7314151088002	5	81
6700SM-9	7314151088019	5	81
6700SZ-1/2	7314151088194	5	81
6700SZ-1/4	7314151088132	5	81
6700SZ-1/8	7314150346349	5	81
6700SZ-11/32	7314151088163	5	81
6700SZ-3/16	7314151088118	5	81
6700SZ-3/8	7314151088170	5	81
6700SZ-5/16	7314151088156	5	81
6700SZ-5/32	7314151808556	5	81
6700SZ-7/16	7314151088187	5	81
6700SZ-7/32	7314151088125	5	81
6700SZ-9/16	7314151088200	5	81
6700SZ-9/32	7314151088149	5	81
6700TORX-E10	7314153011725	5	81
6700TORX-E4	7314153011671	5	81
6700TORX-E5	7314153011688	5	81
6700TORX-E6	7314153011695	5	81
6700TORX-E7	7314153011701	5	81
6700TORX-E8	7314153011718	5	81
6706TE	7314150220199	1	71
6708DMB	7314150220205	1	71
6709-IP10	7314150354498	1	86
6709-IP15	7314150354504	1	86
6709-IP20	7314150354511	1	86
6709-IP25	7314150354528	1	86
6709-IP27	7314150354535	1	86
6709-IP30	7314150354542	1	86
6709-IP40	7314150354559	1	86
6709-IP45	7314150354566	1	86
6709-IP6	7314150460373	1	86
6709-IP7	7314150460366	1	86
6709-IP8	7314150460359	1	86
6709-IP9	7314150460342	1	86
6709F-4.5	7314151830762	5	85
6709F-5.5	7314151830779	5	85
6709F-6.5	7314150220397	5	85
6709F-8	7314151830786	5	85
6709HL	7314150128457	100	84
6709M-10	7314150430833	5	86
6709M-3	7314151830656	5	86
6709M-4	7314151830663	5	86
6709M-5	7314151830670	5	86
6709M-6	7314151830687	5	86
6709M-8	7314151830694	5	86
6709PH-1	7314151830700	5	85
6709PH-2	7314151830717	5	85
6709PH-3	7314151830724	5	85
6709PH-4	7314150489725	5	85
6709PZ-1	7314151830731	5	85
6709PZ-2	7314151830748	5	85
6709PZ-3	7314151830755	5	85
6709TORX-R-T10	7314153002471	1	86
6709TORX-R-T15	7314153002488	1	86
6709TORX-R-T20	7314153002495	1	86
6709TORX-R-T25	7314153002501	1	86
6709TORX-R-T8	7314153002464	1	86
6709TORX-T10	7314151811679	5	86
6709TORX-T15	7314151811686	5	86
6709TORX-T20	7314151811693	5	86
6709TORX-T25	7314151811709	5	86
6709TORX-T27	7314151811716	5	86
6709TORX-T30	7314151811723	5	86
6709TORX-T40	7314153002457	5	86
6709TORX-T6	7314150460540	5	86
6709TORX-T7	7314150460557	5	86
6709TORX-T8	7314153002440	5	86
6709TORX-T9	7314151811662	5	86
671002600*	8413345128971	50	541
671002850*	8413345128988	1	541
6711MB	7314150220298	1	71
6712RN	7314151838232	1	67
6713MH	7314150220212	1	71
6715GE	7314151831370	1	69
6715GJ	7314151831363	1	69
6715MG	7314151831349	1	69
6715MGS	7314151831332	1	67
6715MZ	7314153003218	1	70
6715PZ	7314151837525	1	69
6717MBP	7314150218806	1	68
6719MHR	7314150218783	1	68
6719SM	7314151820817	1	68
6720NM	7314151088262	1	70
6721NM	7314151088309	1	69
6722M	7314151594411	1	69
6729MHP	7314150218752	1	68
6729MHR	7314150218769	1	68
6729SM	7314153003225	1	70



6729SZ	7314153003232	1	70
6730MBP	7314150218776	1	68
677-10	7314150362486	1	53
677-13	7314150362493	1	53
677-3/8	7314150362509	1	53
677-7	7314150362455	1	53
677-8	7314150362462	1	53
677-9	7314150362479	1	53
679-1/2	7314150363384	1	56
679-10	7314150357345	1	56
679-11	7314150357352	1	56
679-12	7314150357369	1	56
679-13	7314150357376	1	56
679-14	7314150357383	1	56
679-3/8	7314150363360	1	56
679-7	7314150357536	1	56
679-7/16	7314150363377	1	56
679-8	7314150357079	1	56
679-9	7314150357338	1	56
679-9/16	7314150363391	1	56
6852-5	7314150125463	1	117
6852-5/S17	7314150135875	1	118
6852P-5	7314150416585	1	118
6876N	7314151845575	1	118
6878N	7314151845582	1	118
6880N	7314151845599	1	118
690000160	8413345008068	1	596
690000200	8413345008082	1	596
690000220	8413345008099	1	596
690000250	8413345008105	1	596
690000300	8413345008129	1	596
690000320	8413345087476	1	596
690000350	8413345008136	1	596
690000400	8413345008143	1	596
690000500	8413345008167	1	596
690000630	8413345111065	1	596
69079019P	8413345111089	1	596
690900080	8413345016209	4	596
690900100	8413345016216	4	596
690900120	8413345016223	2	596
690900140	8413345016230	2	596
690900200	8413345016247	1	596
6950	7314151089641	1	87
6950-SPARE	7314150187867	1	88
6950CBR	7314150535781	10	88
6950MH	7314150535101	10	87
6950MHS	7314150535118	10	87
6950QR	7314150540198	10	87
6950QRS	7314150540211	10	87
6950RN	7314151831189	1	87
6950RN-SPARE	7314150209149	1	88
6950SL	7314150197668	1	87
6950SL-SPARE	7314150210251	1	88
6951	7314151089764	1	88
6954-5	7314150489183	10	83
6956	7314151089825	10	83
6956MH	7314150537365	10	83
6957-6	7314150537341	10	83
6958-6	7314150476329	1	83
6960-14	7314150489343	1	84
6960-3	7314150489381	10	84
6960-6	7314150489428	10	84
6960F-6	7314150489206	20	84
6960W-2	7314150470860	10	84
6960W-4	7314150470877	1	84
6960W-6	7314150470884	10	84
6966	7314151089986	10	84
6968	7314150128426	100	84
6969	7314150489268	1	85
696EX-01	7314150386192	1	84
696EX-06*	7314150386239	1	84
696EX-11	7314150386208	1	84
6972H	7314151215934	1	84
6973A	7314150339495	10	84
6973M	7314150339501	1	84
6973N	7314151845605	1	117
6976N	7314151845612	1	117
6978N	7314151845629	1	117
6M-10-11	7314151832094	10	50
6M-10-13	7314151832117	10	50
6M-12-13	7314151832131	10	50
6M-12-14	7314151832148	10	50
6M-13-14	7314151832155	10	50
6M-13-15	7314151832162	10	50
6M-13-16	7314151832179	10	50
6M-13-17	7314151832186	10	50
6M-14-15	7314151832193	10	50
6M-14-17	7314151832209	10	50
6M-16-17	7314151832216	10	50
6M-16-18	7314151832223	10	50
6M-17-19	7314151832230	10	50
6M-18-19	7314151832247	10	50
6M-19-22	7314151832261	10	50
6M-19-24	7314151832278	10	50
6M-20-22	7314151832285	10	50
6M-21-23	7314151832292	10	50

* Until stocks last



6M-21-24	7314151838072	10	50
6M-22-24	7314151832308	10	50
6M-24-26	7314151832315	10	50
6M-24-27	7314151832322	10	50
6M-24-30	7314151832339	5	50
6M-25-28	7314151832353	5	50
6M-27-29	7314150189861	5	50
6M-27-30	7314151832360	5	50
6M-27-32	7314151832377	5	50
6M-30-32	7314151832384	5	50
6M-30-36	7314151832407	5	50
6M-32-36	7314151832414	5	50
6M-34-36	7314151832421	1	50
6M-36-41	7314151832438	1	50
6M-38-42	7314151832445	1	50
6M-4-5	7314151832018	10	50
6M-4.5-5.5	7314151832025	10	50
6M-41-46	7314151832452	1	50
6M-46-50	7314151832469	1	50
6M-5-5.5	7314151832032	10	50
6M-5.5-7	7314151832049	10	50
6M-6-7	7314151832056	10	50
6M-7-8	7314151832063	10	50
6M-8-10	7314151832087	10	50
6M-8-9	7314151832070	10	50
6M/10C	7314150212934	1	52
6M/12C	7314150212941	1	52
6M/6C	7314150212910	1	51
6M/8C	7314150212927	1	52
6M/S8	7314151832483	1	51
6M/SH12	7314153013439	1	51
6M/SH8	7314150201365	1	51
6MV-10	7314150120871	5	489
6MV-11	7314150120888	5	489
6MV-12	7314150120895	5	489
6MV-13	7314150120901	5	489
6MV-14	7314150120918	5	489
6MV-15	7314150120925	5	489
6MV-16	7314150120932	5	489
6MV-17	7314150120949	3	489
6MV-18	7314150120956	3	489
6MV-19	7314150120963	3	489
6MV-20	7314150120970	3	489
6MV-21	7314150120987	3	489
6MV-22	7314150120994	3	489
6MV-23	7314150121007	3	489
6MV-24	7314150121014	3	489
6MV-27	7314150121021	2	489
6MV-30	7314150121038	2	489
6MV-32	7314150121052	2	489
6MV-6	7314150120833	5	489
6MV-7	7314150120840	5	489
6MV-8	7314150120857	5	489
6MV-9	7314150120864	5	489
6MV/10T	7314150213023	1	492
6MV/8T	7314150122141	1	492
6Z-1-1.1/8	7314151832674	1	51
6Z-1.1/16-1.1/4	7314151832681	1	51
6Z-1.1/4-1.3/8	7314151832698	1	51
6Z-1/2-9/16	7314151832568	5	51
6Z-1/4-5/16	7314151832520	5	51
6Z-11/16-3/4	7314151832612	5	51
6Z-13/16-7/8	7314151832643	5	51
6Z-15/16-1	7314151832667	5	51
6Z-19/32-11/16	7314151832582	5	51
6Z-25/32-13/16	7314151832636	5	51
6Z-3/4-7/8	7314151832629	5	51
6Z-3/8-7/16	7314151832544	5	51
6Z-5/16-11/32	7314151832537	5	51
6Z-5/8-3/4	7314151832605	5	51
6Z-7/16-1/2	7314151832551	5	51
6Z-7/8-15/16	7314151832650	5	51
6Z-9/16-5/8	7314151832575	5	51
6Z/8C	7314150212958	1	52
700-1-50	7314153017673	5	220
700-1.2-50	7314153017680	5	220
700-1.5-50	7314153017697	5	220
700-1.8-50	7314153017703	5	220
700-2-50	7314153017710	5	220
700-2.5-50	7314153017741	5	220
700-3-100	7314153017772	5	220
700-3-200	7314153017789	5	220
700-3-50	7314153017765	5	220
700-3.5-75	7314153017796	5	220
700-4-250	7314153017819	5	220
700-4-75	7314153017802	5	220
701-0-200	7314153017857	5	220
701-0-50	7314153017840	5	220
701-00-50	7314153017833	5	220
701-1-250	7314153017871	5	220
701-1-75	7314153017864	5	220
702-0-50	7314153017888	5	220
702-1-75	7314153017895	5	220
703-10-50	7314153017963	5	220
703-15-75	7314153017970	5	220
703-20-75	7314153017987	5	220





703-4-50	7314153017901	5	220
703-5-50	7314153017918	5	220
703-6-50	7314153017925	5	220
703-7-50	7314153017932	5	220
703-8-50	7314153017949	5	220
703-9-50	7314153017956	5	220
704-1.5-50	7314153017994	5	221
704-2-50	7314153018007	5	221
704-2.5-50	7314153018014	5	221
704-3-75	7314153018021	5	221
704Z-3/32	7314150137428	5	221
706-1	7314153018045	1	219
706-2	7314153018052	1	219
706-3	7314153018069	1	219
706-4	7314153018076	1	219
706-5	7314153018083	1	220
70S/1.2-8.0-2P	7314150262823	25	175
70S/1.6-10.0-2P	7314150261017	25	175
70S/1.6-9.0	7314150218400	1	175
70S/1.6-9.0-2P	7314150261024	25	175
70S/2.0-12.0	7314150218417	1	175
70S/2.0-12.0-2P	7314150261086	25	175
70S/2.5-14.0	7314150218424	1	175
70S/2.5-14.0-2P	7314150261147	25	175
70S/H10*	7314150218486	1	176
70S/H10-2P	7314150261451	25	176
70S/H12	7314150218493	1	176
70S/H12-2P	7314150261468	25	176
70S/H14	7314150218509	1	176
70S/H14-2P	7314150261475	25	176
70S/H4	7314150218431	1	176
70S/H4-2P	7314150261352	25	176
70S/H5-2P	7314150261406	25	176
70S/H6-2P	7314150261437	25	176
70S/H7	7314150218462	1	176
70S/H7-2P	7314150261444	25	176
70S/H8-2P	7314150262847	25	176
70S/PH1	7314150217557	1	176
70S/PH1-2P	7314150260621	25	176
70S/PH2	7314150217564	1	176
70S/PH2-2P	7314150260638	25	176
70S/PH3	7314150217571	1	176
70S/PH3-2P	7314150260645	25	176
70S/PH4	7314150217588	1	176
70S/PH4-2P	7314150260652	25	176
70S/PZ1	7314150217595	1	176
70S/PZ1-2P	7314150260683	25	176
70S/PZ2	7314150217601	1	176
70S/PZ2-2P	7314150260706	25	176
70S/PZ3	7314150217724	1	176
70S/PZ3-2P	7314150260720	25	176
70S/PZ4	7314150217731	1	176
70S/PZ4-2P	7314150260737	25	176
70S/T20	7314150217748	1	176
70S/T20-2P	7314150260744	25	176
70S/T25-2P	7314150260812	25	176
70S/T25-5P	7314150538508	50	176
70S/T27-2P	7314150260867	1	176
70S/T30-2P	7314150260881	25	176
70S/T40-5P	7314150538560	50	176
70S/T45	7314150217793	1	176
70S/T45-2P	7314150260904	25	176
70S/T50	7314150217809	1	176
70S/T50-2P*	7314150260911	25	176
70S/T55	7314150217816	1	176
70S/T55-2P	7314150260928	25	176
70S/TS1/4	7314150218349	1	176
70S/TS1/4-2P	7314150260935	25	176
70S/TS10	7314150218356	1	176
70S/TS10-2P	7314150260942	25	176
70S/TS5/16	7314150218363	1	176
70S/TS5/16-2P	7314150260959	25	176
70S/TS8	7314150218370	1	176
70S/TS8-2P	7314150260966	25	176
7106J*	7314150339518	1	92
7154TC	7314150475148	10	634
7190	7314150052479	10	630
7190 CO	7314150052790	10	630
7191	7314150052509	10	630
7191 CO	7314150052806	10	630
7223	7314150237722	4	251
7223D*	7314150421527	8	251
7223D IP*	7314150440306	8	251
7223IP	7314150421855	8	251
7224	7311518274733	4	251
7224-622XD-3P	7314150426973	1	252
7224IP	7314150421831	4	251
7224S	7314150421657	4	489
7225	7314150237739	8	251
7225D*	7314150421541	4	251
7225D IP*	7314150440320	4	251
7225IP	7314150421848	4	251
7280	7314150052523	10	632
7285	7314150052530	10	632
7290	7314150052547	10	631
7291	7314150052554	10	631



7292	7314150052578	10	631
7292G	7314150434701	10	633
7293	7314150052592	10	631
7372I-2-63	7314151398668	10	225
7372I-2.5-75	7314151399047	10	225
7372I-3-80	7314151341602	10	225
7400SM-10	7314151092955	5	88
7400SM-11	7314151092962	5	88
7400SM-12	7314151092979	5	88
7400SM-13	7314151092986	5	88
7400SM-14	7314151092993	5	88
7400SM-15	7314151093006	5	88
7400SM-16	7314151831127	5	88
7400SM-17	7314151093020	5	88
7400SM-18	7314151831134	5	88
7400SM-19	7314151093044	5	88
7400SM-20	7314153002570	5	88
7400SM-21	7314153002587	5	88
7400SM-22	7314153002594	5	88
7400SM-6	7314151092917	5	88
7400SM-7	7314151092924	5	88
7400SM-8	7314151092931	5	88
7400SM-9	7314151092948	5	88
7400SR/S12	7314153003294	1	73
7400SZ-1/2	7314150385942	1	89
7400SZ-1/4	7314150385959	1	89
7400SZ-11/16	7314150385966	1	89
7400SZ-11/32	7314150385973	1	89
7400SZ-13/16	7314150385980	1	89
7400SZ-3/4	7314150385997	1	89
7400SZ-3/8	7314150386000	1	89
7400SZ-5/16	7314150386017	1	89
7400SZ-5/8	7314150386024	1	89
7400SZ-7/16	7314150386031	1	89
7400SZ-7/8	7314150386048	1	89
7400SZ-9/16	7314150386055	1	89
7400TORX-E10	7314153003058	5	90
7400TORX-E11	7314153003065	5	90
7400TORX-E12	7314153003072	5	90
7400TORX-E14	7314153003089	5	90
7400TORX-E16	7314153003096	5	90
7400TORX-E18	7314153003102	5	90
7400TORX-E8	7314150118243	5	90
7400TORX-ER/S7	7314153003300	1	73
7402GPR-16	7314150503087	120	303
7402GPR-18	7314150503094	120	303
7402GPR-21	7314150503100	100	303
7406ZZ-16	7314153011992	1	303
7406ZZ-21	7314153012005	1	303
7407H	7314151218249	1	180
7408H	7314151218300	1	180
7408MD	7314150220328	1	73
7409BH-10	7314153002112	5	94
7409BH-4	7314153002075	5	94
7409BH-5	7314153002082	5	94
7409BH-6	7314153002099	5	94
7409BH-8	7314153002105	5	94
7409F-10	7314153002143	5	93
7409F-6.5	7314153002129	5	93
7409F-8	7314153002136	5	93
7409H	7314151218355	1	180
7409M-10	7314153001962	5	94
7409M-3	7314153002235	5	94
7409M-4	7314153001900	5	94
7409M-5	7314153001917	5	94
7409M-6	7314153001924	5	94
7409M-7	7314153001931	5	94
7409M-8	7314153001948	5	94
7409MB	7314150220236	1	73
7409MR/S7	7314153003256	1	94
7409PH-1	7314153002150	5	93
7409PH-2	7314153002167	5	93
7409PH-3	7314153002174	5	93
7409TORX-R-T27	7314153001856	5	93
7409TORX-R-T30	7314153001863	5	93
7409TORX-R-T40	7314153001870	5	93
7409TORX-R-T45	7314153001887	5	93
7409TORX-R-T50	7314153001894	5	93
7409TORX-T20	7314150220403	5	93
7409TORX-T25	7314153001771	5	93
7409TORX-T25-L	7314153011237	5	94
7409TORX-T27	7314153001788	5	93
7409TORX-T30	7314153001795	5	93
7409TORX-T30-L	7314153011244	5	94
7409TORX-T40	7314153001801	5	93
7409TORX-T40-L	7314153011251	5	94
7409TORX-T45	7314153001818	5	93
7409TORX-T45-L	7314153011268	5	94
7409TORX-T50	7314153001825	5	93
7409TORX-T50-L	7314153011275	5	94
7409TORX-TRR/S5	7314153003263	1	93
7409Z-1/4	7314150386062	1	94
7409Z-1/8	7314150386079	1	94
7409Z-3/16	7314150386086	1	94
7409Z-3/8	7314150386093	1	94
7409Z-5/32	7314150386109	1	94



7409Z-7/32	7314150386116	1	94
7422MBR	7314150218844	1	73
7422MHR	7314150218868	1	73
7444SG-M-100	7314151830014	1	57
7444SG-M-105	7314151830021	1	57
7444SG-M-110	7314151830038	1	57
7444SG-M-115	7314151830045	1	57
7444SG-M-120	7314151830052	1	57
7444SG-M-125	7314151830069	1	57
7444SG-M-130	7314151830076	1	57
7444SG-M-135	7314151830083	1	57
7444SG-M-140	7314151830090	1	57
7444SG-M-145	7314151830106	1	57
7444SG-M-150	7314151830113	1	57
7444SG-M-155	7314151830120	1	57
7444SG-M-160	7314150132508	1	57
7444SG-M-165	7314150132515	1	57
7444SG-M-170	7314150132522	1	57
7444SG-M-175	7314150132539	1	57
7444SG-M-24	7314150205400	1	57
7444SG-M-27	7314151829834	1	57
7444SG-M-30	7314151829841	1	57
7444SG-M-32	7314151829858	1	57
7444SG-M-34	7314151838560	1	57
7444SG-M-36	7314151829865	1	57
7444SG-M-38	7314150180936	1	57
7444SG-M-41	7314151829872	1	57
7444SG-M-42	7314151829889	1	57
7444SG-M-46	7314151829896	1	57
7444SG-M-50	7314151829919	1	57
7444SG-M-55	7314151829926	1	57
7444SG-M-60	7314151829933	1	57
7444SG-M-65	7314151829940	1	57
7444SG-M-70	7314151829957	1	57
7444SG-M-75	7314151829964	1	57
7444SG-M-80	7314151829971	1	57
7444SG-M-85	7314151829988	1	57
7444SG-M-90	7314151829995	1	57
7444SG-M-95	7314151830007	1	57
7444SG-Z-1.1/16	7314150132546	1	57
7444SG-Z-1.1/4	7314150132577	1	57
7444SG-Z-1.1/8	7314150132553	1	57
7444SG-Z-1.11/16	7314150132638	1	57
7444SG-Z-1.13/16*	7314150132652	1	57
7444SG-Z-1.3/16	7314150132560	1	57
7444SG-Z-1.3/4	7314150132645	1	57
7444SG-Z-1.3/8	7314150132591	1	57
7444SG-Z-1.5/16	7314150132584	1	57
7444SG-Z-1.5/8	7314150132621	1	57
7444SG-Z-1.7/16	7314150132607	1	57
7444SG-Z-1.7/8	7314150132669	1	57
7444SG-Z-2	7314150132676	1	57
7444SG-Z-2.1/16	7314150132683	1	57
7444SG-Z-2.1/4	7314150132713	1	57
7444SG-Z-2.1/8	7314150132690	1	57
7444SG-Z-2.3/16	7314150132706	1	57
7444SG-Z-2.3/4	7314150132768	1	57
7444SG-Z-2.3/8	7314150132720	1	57
7444SG-Z-2.5/8	7314150132751	1	57
7444SG-Z-2.9/16	7314150132744	1	57
7444SG-Z-3	7314150132775	1	57
7444SG-Z-3.1/2	7314150132805	1	57
7444SG-Z-3.1/8	7314150132782	1	57
7444SG-Z-3.3/4	7314150132812	1	57
7444SG-Z-3.3/8	7314150132799	1	57
7444SG-Z-3.7/8	7314150132829	1	57
7444SG-Z-4	7314150132836	1	57
7444SG-Z-4.1/2	7314150132850	1	57
7444SG-Z-4.1/8	7314150132843	1	57
7454-1400*	7314150119592	1	115
7454-1400E*	7314150119615	1	115
7454-140A*	7314150509515	1	114
7454-17*	7314150509492	1	114
7454-230*	7314150509522	1	114
7454-3.5*	7314150509478	1	114
7454-32*	7314150509508	1	114
7454-480*	7314150119578	1	115
7454-70A*	7314150509577	1	114
7454-8.4*	7314150509485	1	114
7454-800A*	7314150509584	1	114
7454-800E*	7314150119608	1	115
7455-100	7314150125111	1	113
7455-1000	7314150368303	1	113
7455-100A	7314150340156	1	113
7455-15	7314150119646	1	112
7455-1500	7314150125166	1	113
7455-20	7314150125074	1	112
7455-200	7314150125128	1	113
7455-25	7314150125081	1	112
7455-2500	7314150125173	1	113
7455-300	7314150125104	1	113
7455-340	7314150125135	1	113
7455-5	7314150119639	1	112
7455-500	7314150125142	1	113
7455-60	7314150125098	1	112
7455-800	7314150125159	1	113

* Until stocks last



7456-80LB	7314150119783	1	113
7465-100	7314150340200	1	113
7465-15	7314150340170	1	113
7465-1500	7314150340248	1	113
7465-200	7314150340217	1	113
7465-30	7314150340187	1	113
7465-340	7314150340224	1	113
7465-5	7314150340163	1	113
7465-60	7314150340194	1	113
7465-800	7314150340231	1	113
747-1	7314150362899	1	53
747-1.1/16	7314150362905	1	53
747-1.1/2	7314150362974	1	53
747-1.1/4	7314150362936	1	53
747-1.1/8	7314150362912	1	53
747-1.11/16	7314150363001	1	53
747-1.13/16	7314150363025	1	53
747-1.15/16	7314150363049	1	53
747-1.3/16	7314150362929	1	53
747-1.3/4	7314150363018	1	53
747-1.3/8	7314150362950	1	53
747-1.5/16	7314150362943	1	53
747-1.5/8	7314150362998	1	53
747-1.7/16	7314150362967	1	53
747-1.7/8	7314150363032	1	53
747-1.9/16	7314150362981	1	53
747-1/2	7314150362813	1	53
747-10	7314150362516	1	53
747-11	7314150362523	1	53
747-11/16	7314150362844	1	53
747-12	7314150362530	1	53
747-13	7314150362547	1	53
747-13/16	7314150362868	1	53
747-14	7314150362554	1	53
747-15	7314150362561	1	53
747-15/16	7314150362882	1	53
747-16	7314150362578	1	53
747-17	7314150362585	1	53
747-18	7314150362592	1	53
747-19	7314150362608	1	53
747-2	7314150363056	1	53
747-2.1/16	7314150363063	1	53
747-2.1/2	7314150363131	1	53
747-2.1/4	7314150363094	1	53
747-2.1/8	7314150363070	1	53
747-2.3/16	7314150364893	1	53
747-2.3/4	7314150363162	1	53
747-2.3/8	7314150363117	1	53
747-2.5/16	7314150363100	1	53
747-2.5/8	7314150363155	1	53
747-2.7/16	7314150363124	1	53
747-2.7/8	7314150363179	1	53
747-2.9/16	7314150363148	1	53
747-20	7314150362615	1	53
747-21	7314150362622	1	53
747-22	7314150362639	1	53
747-23	7314150362646	1	53
747-24	7314150362653	1	53
747-25	7314150362660	1	53
747-26	7314150362677	1	53
747-27	7314150362684	1	53
747-28	7314150362691	1	53
747-3/4	7314150362851	1	53
747-3/8	7314150362790	1	53
747-30	7314150362707	1	53
747-32	7314150362714	1	53
747-34	7314150362721	1	53
747-36	7314150362738	1	53
747-40	7314150362745	1	53
747-41	7314150362752	1	53
747-42	7314150362769	1	53
747-46	7314150362776	1	53
747-5/8	7314150362837	1	53
747-50	7314150362783	1	53
747-7/16	7314150362806	1	53
747-7/8	7314150362875	1	53
747-9/16	7314150362820	1	53
749-1	7314150363506	1	56
749-1.1/16	7314150363513	1	56
749-1.1/2	7314150363582	1	56
749-1.1/4	7314150363544	1	56
749-1.1/8	7314150363520	1	56
749-1.11/16	7314150363612	1	56
749-1.13/16	7314150363636	1	56
749-1.15/16	7314150363650	1	56
749-1.3/16	7314150363537	1	56
749-1.3/4	7314150363629	1	56
749-1.3/8	7314150363568	1	56
749-1.5/16	7314150363551	1	56
749-1.5/8	7314150363605	1	56
749-1.7/16	7314150363575	1	56
749-1.7/8	7314150363643	1	56
749-1.9/16	7314150363599	1	56
749-1/2	7314150363421	1	56
749-10	7314150538386	10	56
749-11	7314150538362	10	56





749-11/16	7314150363452	1	56
749-13	73141503538348	10	56
749-13/16	7314150363476	1	56
749-14	73141503538324	10	56
749-15	7314150357543	1	56
749-15/16	7314150363490	1	56
749-16	7314150357550	1	56
749-17	7314150357567	1	56
749-18	7314150357574	1	56
749-19	7314150357581	1	56
749-2	7314150363667	1	56
749-2.1/4	7314150363698	1	56
749-2.1/8	7314150363674	1	56
749-2.3/16	7314150363681	1	56
749-2.3/4	7314150363728	1	56
749-2.3/8	7314150363704	1	56
749-2.5/8	7314150363711	1	56
749-20	7314150357598	1	56
749-21	7314150357604	1	56
749-22	7314150357611	1	56
749-23	7314150357628	1	56
749-24	7314150357635	1	56
749-25	7314150357642	1	56
749-26	7314150357659	1	56
749-27	7314150357666	1	56
749-3.1/8	7314150363735	1	56
749-3/4	7314150363469	1	56
749-3/8	7314150363407	1	56
749-5/8	7314150363445	1	56
749-7/16	7314150363414	1	56
749-7/8	7314150363483	1	56
749-9/16	7314150363438	1	56
7490	7314150052646	10	635
7490 CO	7314150052875	10	635
74P14-200	7314150416318	1	116
74P14-300	7314150416325	1	116
74P14-400	7314150416332	1	116
74P9-100	7314150416301	1	116
74P9-20	7314150416288	1	116
74P9-60	7314150416295	1	116
74PR-100	7314150416189	1	115
74PR-100A	7314150416196	1	115
74PR-20	7314150416158	1	115
74PR-200	7314150416202	1	115
74PR-300	7314150416219	1	115
74PR-400	7314150416226	1	115
74PR-60	7314150416165	1	115
74PR-60A	7314150416172	1	115
74PS-100	7314150416257	1	116
74PS-20	7314150416233	1	116
74PS-200	7314150416264	1	116
74PS-300	7314150416271	1	116
74PS-60	7314150416240	1	116
74S/H10	7314150218622	1	171
74S/H10-2P	7314150261635	25	171
74S/H12	7314150218639	1	171
74S/H12-2P	7314150261659	25	171
74S/H14	7314150218646	1	171
74S/H14-2P	7314150261666	1	171
74S/H17	7314150218653	1	171
74S/H17-2P	7314150261673	25	171
74S/H4	7314150218578	1	171
74S/H4-2P	7314150261543	25	171
74S/H5-2P	7314150261550	25	171
74S/H6	7314150218592	1	171
74S/H6-2P	7314150261567	25	171
74S/H7	7314150218608	1	171
74S/H7-2P	7314150261574	25	171
74S/H8	7314150218615	1	171
74S/H8-2P	7314150261611	25	171
74W14-200	7314150415700	1	112
74W14-300	7314150415717	1	112
74W14-400	7314150415724	1	112
74W9-100	7314150415687	1	112
74W9-15	7314150415656	1	112
74W9-200	7314150415694	1	112
74W9-25	7314150415663	1	112
74W9-50	7314150415670	1	112
74WR-100	7314150415540	1	112
74WR-100B	7314150469871	1	112
74WR-15	7314150415519	1	112
74WR-200	7314150415557	1	112
74WR-25	7314150415526	1	112
74WR-300	7314150415564	1	112
74WR-340	7314150415571	1	112
74WR-400	7314150415588	1	112
74WR-50	7314150415533	1	112
74WS-100	7314150415625	1	112
74WS-15	7314150415595	1	112
74WS-200	7314150415632	1	112
74WS-25	7314150415601	1	112
74WS-300	7314150415649	1	112
74WS-50	7314150415618	1	112
7590	7314150052660	10	635
7590 CO	7314150052882	10	635
7591	7314150197491	1	635



75EXT	7314150415311	1	117
75P1-1500	7314150415298	1	116
75P3-1000	7314150415281	1	116
75P3-650	7314150415267	1	116
75P3-800	7314150415274	1	116
75PS-650	7314150415328	1	116
75R1-1500	7314150415236	1	113
75R3-1000	7314150415229	1	113
75R3-650	7314150415205	1	113
75R3-800	7314150415212	1	113
75S-650	7314150415243	1	114
76R1-2000	7314150522378	1	114
76R3-1000	7314150422128	1	114
76R3-1500	7314150422135	1	114
76R3-600	7314150423118	1	114
76R3-800	7314150422111	1	114
76S-600	7314150423125	1	114
7710	7314151551445	1	93
7710-SO/1*	7314151809744	1	92
7750	7314151096427	1	95
7750-SPARE	7314150187874	1	95
7750MH	7314150537761	5	92
7750QR	7314150540174	10	92
7750RN	7314151831240	1	92
7750RN-SPARE	7314150209361	1	95
7750SL	7314150197675	1	92
7750SL-SPARE	7314150210268	1	95
7751	73141505386949	10	94
7752	7314151096533	1	90
7754-8	7314150539871	10	90
7755-SO/1	7314153010728	1	94
7756	7314150489152	6	90
7756MH	7314150537785	10	91
7758-10	7314150470891	1	90
7759	7314151096601	1	91
7760-3	7314150539949	32	91
7760-5	7314150539963	10	91
7760W-3	7314150470907	10	91
7760W-6	7314150470914	10	91
7766	7314151096694	1	91
7767	7314153003577	1	85
7768	7314150128433	50	91
776EX-01*	7314150386130	1	91
776EX-03*	7314150386154	1	91
776EX-04*	7314150386161	1	91
776EX-08*	7314150386185	1	91
7771	7314150539895	5	91
7772	7314150539918	40	91
7772H	7314150476336	10	98
7773A	7314150512270	20	92
7800DM-10	7314151096991	10	96
7800DM-11	7314151097011	10	96
7800DM-12	7314151097035	10	96
7800DM-13	7314151097059	10	96
7800DM-14	7314151097073	10	96
7800DM-15	7314151097097	10	96
7800DM-16	7314151097110	10	96
7800DM-17	7314151097134	10	96
7800DM-18	7314151097158	10	96
7800DM-19	7314151097172	10	96
7800DM-20	7314151097196	10	96
7800DM-21	7314151097219	10	96
7800DM-22	7314151097233	10	96
7800DM-23	7314151097257	10	96
7800DM-24	7314151097271	10	96
7800DM-25	7314151097295	10	96
7800DM-26	7314151097318	10	96
7800DM-27	7314151097332	10	96
7800DM-28	7314151097356	10	96
7800DM-29	7314151097363	10	96
7800DM-30	7314151097370	10	96
7800DM-31	7314150464548	10	96
7800DM-32	7314151097387	10	96
7800DM-33	7314150169351	10	96
7800DM-34	7314150169405	10	96
7800DM-36	7314151097400	10	96
7800DM-8	7314151830854	10	96
7800DM-9	7314151830861	10	96
7800DMV-10	7314150121656	10	490
7800DMV-11	7314150121663	10	490
7800DMV-12	7314150121670	10	490
7800DMV-13	7314150121687	10	490
7800DMV-14	7314150121694	10	490
7800DMV-15	7314150121700	10	490
7800DMV-16	7314150121717	10	490
7800DMV-17	7314150121724	10	490
7800DMV-18	7314150121731	10	490
7800DMV-19	7314150121748	10	490
7800DMV-20	7314150121755	10	490
7800DMV-21	7314150121762	10	490
7800DMV-22	7314150121779	10	490
7800DMV-24	7314150121786	5	490
7800DMV-27	7314150121793	5	490
7800DMV-30	7314150121809	5	490
7800DMV-32	7314150121816	5	490
7800DMV-8	7314150121649	10	490



7800DZ-1	7314151097561	10	96
7800DZ-1.1/16	7314151097578	10	96
7800DZ-1.1/2	7314150464562	10	96
7800DZ-1.1/4	7314151097608	10	96
7800DZ-1.1/8	7314151097585	10	96
7800DZ-1.3/16	7314151097592	10	96
7800DZ-1.3/8	7314150464586	10	96
7800DZ-1.5/16	7314150166077	10	96
7800DZ-1.7/16	7314150464609	1	96
7800DZ-1/2	7314151097455	10	96
7800DZ-11/16	7314151097493	10	96
7800DZ-11/32	7314150465712	10	96
7800DZ-13/16	7314151097523	10	96
7800DZ-13/32	7314150464623	10	96
7800DZ-15/16	7314151097554	10	96
7800DZ-19/32	7314151097479	10	96
7800DZ-25/32	7314151097516	10	96
7800DZ-3/4	7314151097509	10	96
7800DZ-3/8	7314151097431	10	96
7800DZ-5/16	7314150464647	10	96
7800DZ-5/8	7314151097486	10	96
7800DZ-7/16	7314151097448	10	96
7800DZ-7/8	7314151097530	10	96
7800DZ-9/16	7314151097462	10	96
7800SM-10	7314151097851	10	95
7800SM-11	7314151097868	10	95
7800SM-12	7314151097875	10	95
7800SM-13	7314151097882	10	95
7800SM-14	7314151097899	10	95
7800SM-15	7314151097905	10	95
7800SM-16	7314151097912	10	95
7800SM-17	7314151097929	10	95
7800SM-18	7314151097936	10	95
7800SM-19	7314151097943	10	95
7800SM-20	7314150166206	10	95
7800SM-21	7314151097967	10	95
7800SM-22	7314151097974	10	95
7800SM-23	7314151097981	10	95
7800SM-24	7314151097998	10	95
7800SM-25	7314151098001	10	95
7800SM-26	7314151830823	10	95
7800SM-27	7314151098025	10	95
7800SM-28	7314151830830	10	95
7800SM-29	7314150166213	10	95
7800SM-30	7314151098056	10	95
7800SM-32	7314151098063	10	95
7800SM-33	7314150167319	10	95
7800SM-34	7314153011305	10	95
7800SM-36	7314151098087	10	95
7800SM-8	7314151830793	10	95
7800SM-9	7314151830809	10	95
7800SPL-10	7314150549023	10	97
7800SPL-11	7314150549030	10	97
7800SPL-12	7314150549641	10	97
7800SPL-13	7314150549665	10	97
7800SPL-14	7314150549689	10	97
7800SPL-15	7314150549702	10	97
7800SPL-16	7314150549726	10	97
7800SPL-17	7314150549740	10	97
7800SPL-18	7314150551224	10	97
7800SPL-19	7314150551231	10	97
7800SPL-20	7314150551262	10	97
7800SPL-21	7314150551286	10	97
7800SPL-22	7314150551309	10	97
7800SPL-23	7314150551323	10	97
7800SPL-24	7314150551347	10	97
7800SPL-27	7314150551361	10	97
7800SPL-30	7314150551385	10	97
7800SPL-32	7314150551408	10	97
7800SZ-1	7314150542659	10	96
7800SZ-1.1/16	7314150542673	10	96
7800SZ-1.1/4	7314150542697	10	96
7800SZ-1.1/8	7314150542710	10	96
7800SZ-1.3/16	7314150528387	10	96
7800SZ-1/2	7314150528400	10	96
7800SZ-11/16	7314150528424	10	96
7800SZ-13/16	7314150528448	10	96
7800SZ-15/16	7314150542734	10	96
7800SZ-3/4	7314150528462	10	96
7800SZ-3/8	7314150528486	10	96
7800SZ-5/8	7314150542758	10	96
7800SZ-7/16	7314150528509	10	96
7800SZ-7/8	7314150528523	10	96
7800SZ-9/16	7314150528547	10	96
7800TORX-E10	7314150166084	1	97
7800TORX-E11	7314150220359	1	97
7800TORX-E12	7314153011800	1	97
7800TORX-E14	7314153011756	1	97
7800TORX-E16	7314153011763	1	97
7800TORX-E18	7314153011770	1	97
7800TORX-E20	7314153011787	1	97
7800TORX-E24	7314153011794	1	97
7800TORX-E8	7314150166091	1	97
7800TORX/9	7314150469741	1	100
7805DM-10	7314151822101	10	96
7805DM-12	7314151098452	10	96

* Until stocks last



7805DM-13	7314151098469	10	96
7805DM-14	7314151098476	10	96
7805DM-15	7314151098483	10	96
7805DM-16	7314151098490	10	96
7805DM-17	7314151098506	10	97
7805DM-18	7314151098513	10	97
7805DM-19	7314151098520	10	97
7805DM-21	7314151098544	10	97
7805DM-22	7314151098551	10	97
7805DM-23	7314150313532	10	97
7805DM-24	7314151098568	10	97
7805DM-26	7314151098582	10	97
7805DM-27	7314151098599	10	97
7805DM-30	7314151098605	10	97
7805DM-32	7314150220281	10	97
7805DM-34	7314150488537	10	97
7805DZ-1*	7314150357758	10	97
7805DZ-1.1/16*	7314150357765	10	97
7805DZ-1.1/2*	7314150357833	10	97
7805DZ-1.1/4*	7314150357796	10	97
7805DZ-1.1/8*	7314150357772	10	97
7805DZ-1.3/16*	7314150357789	10	97
7805DZ-1.3/8*	7314150357819	10	97
7805DZ-1.5/16*	7314150357802	10	97
7805DZ-1.7/16*	7314150357826	10	97
7805DZ-11/16*	7314150357703	10	97
7805DZ-13/16*	7314150357727	10	97
7805DZ-15/16*	7314150357741	10	97
7805DZ-3/4*	7314150357710	10	97
7805DZ-5/8*	7314150357697	10	97
7805DZ-7/8*	7314150357734	10	97
7805GPR-16	7314150503117	120	303
7805GPR-21	7314150503124	100	303
7805SM-10	7314153011312	10	95
7805SM-11	7314150475926	10	95
7805SM-12	7314153011329	10	95
7805SM-13	7314153011336	10	95
7805SM-14	7314153011343	10	95
7805SM-15	7314153011350	10	95
7805SM-16	7314153011367	10	95
7805SM-17	7314153011374	10	95
7805SM-18	7314153011381	10	95
7805SM-19	7314153011398	10	95
7805SM-20	7314153011404	10	95
7805SM-21	7314153011411	10	95
7805SM-22	7314153011428	10	95
7805SM-23	7314153011435	10	95
7805SM-24	7314153011442	10	95
7805SM-25	7314153011459	10	95
7805SM-26	7314153011466	10	95
7805SM-27	7314153011473	10	95
7805SM-28	7314153011480	10	95
7805SM-29	7314153011497	10	95
7805SM-30	7314153011503	10	95
7805SM-32	7314153011527	10	95
7805SM-34	7314153024251	10	95
7805SZ-1.1/2	7314150357987	1	96
7805SZ-1.1/4	7314150357949	1	96
7805SZ-1.3/16	7314150357932	1	96
7805SZ-1.3/8	7314150357963	1	96
7805SZ-1.5/16	7314150357956	1	96
7805SZ-1.7/16	7314150357970	1	96
7806MD	7314150220335	1	79
7807*	7314153012029	1	302
7807H	7314151232764	1	184
7807TE	7314150313792	1	79
7808H	7314151232771	1	184
7808HM	7314150220434	1	101
7809F-10	7314151830892	5	99
7809F-8	7314151830885	5	99
7809H	7314151232788	1	184
7809M-10	7314151815608	1	100
7809M-10-120	7314150509669	1	101
7809M-12	7314151815615	1	100
7809M-12-120	7314150509683	1	101
7809M-14	7314151815622	1	100
7809M-14-120	7314150509706	10	101
7809M-17	7314151831028	1	100
7809M-17-120	7314150509720	10	100
7809M-19	7314151831035	1	100
7809M-19-120	7314150516575	8	101
7809M-4	7314150214600	10	100
7809M-4-120	7314150509591	1	100
7809M-5	7314151815561	1	100
7809M-5-120	7314150509607	1	100
7809M-5-180	7314151830922	1	100
7809M-6	7314151815578	1	100
7809M-6-120	7314150509621	1	100
7809M-7	7314151815585	1	100
7809M-7-100	7314151830960	1	100
7809M-7-120	7314150509645	1	100
7809M-8	7314151815592	1	100
7809M-8-120	7314151830984	1	101
7809M-9	7314151830991	1	100
7809M/10	7314151831448	1	75
7809PH-2	7314151830908	1	99



7809PH-3



7809PH-3	7314151830915	1	99
7809PH-4	7314153003423	1	99
7809PZ-3*	7314153003447	1	100
7809TO	7314150220465	1	100
7809TORX-T20	7314151811730	1	100
7809TORX-T20-120	7314150509768	1	100
7809TORX-T25	7314151811747	1	100
7809TORX-T25-120	7314150509799	1	100
7809TORX-T27	7314151811754	1	100
7809TORX-T27-120	7314150509812	1	100
7809TORX-T30	7314151811761	1	100
7809TORX-T30-120	7314150509836	1	100
7809TORX-T40	7314151811778	1	100
7809TORX-T40-120	7314150220564	1	100
7809TORX-T45	7314151811785	1	100
7809TORX-T45-120	7314150220557	1	100
7809TORX-T50	7314151811792	1	100
7809TORX-T50-100	7314150220540	1	100
7809TORX-T50-120	7314150509850	1	100
7809TORX-T55	7314151811808	1	100
7809TORX-T55-120	7314150509874	1	100
7809TORX-T60	7314151811815	1	100
7809TORX-T60-120	7314150509898	1	100
7809TORX-T70	7314150509744	10	100
7809TORX-T70-120	7314150509911	1	100
7809TORX-T70-140	7314150220526	5	100
7809TORX/10	7314151831455	1	75
7809XZN-10	7314151831080	1	101
7809XZN-10-100	7314151831097	1	101
7809XZN-12	7314151831103	1	101
7809XZN-12-100	7314151831110	1	101
7809XZN-14	7314153004574	1	101
7809XZN-14-100	7314153004567	1	101
7809XZN-16	7314150220458	1	101
7809XZN-18	7314150314058	1	101
7809XZN-6	7314150214617	1	101
7809XZN-8	7314151831066	1	101
7809XZN-8-100	7314151831073	1	101
7809Z-1/2	7314153003515	1	101
7809Z-1/4	7314153003478	1	101
7809Z-17/32	7314150313785	1	101
7809Z-19/32	7314153003546	1	101
7809Z-3/16	7314153003461	1	101
7809Z-3/8	7314153003492	1	101
7809Z-5/16	7314153003485	1	101
7809Z-5/8	7314153003553	1	101
7809Z-7/16	7314153003508	1	101
7809Z-9/16	7314153003539	1	101
7809Z/10	7314153003560	1	75
7810MB	7314150220380	1	78
7810MH	7314150220373	1	78
7811DMV	7314150122134	1	492
7812	7314150502028	100	314
7814DS	7314150318964	1	76
7814DST*	7314150319022	1	78
7817DZS	7314150319008	1	77
7817DZS1	7314150389902	1	77
7818DS	7314150318971	1	76
7818DST	7314150319039	1	78
7818MHR	7314150218912	1	76
7818SST*	7314150319046	1	78
7819DRN	7314151831547	1	77
782-U	7311518276447	1	305
7823	7314150218141	16	177
7823DZS	7314150319015	1	77
7825DST*	7314150319060	1	78
7825MBP	7314150218929	1	76
7825MHP	7314150218943	1	76
7825SST	7314150319053	1	78
783	7311518276034	1	321
7835 G-160	7314150050253	5	248
7842MH	7314150555352	1	75
7847SS	7314150318995	1	77
7851-G	7314150124909	1	121
7851-M	7314150124893	1	121
7865	7311518276720	1	177
787-1.1/16	7314150363186	1	53
787-1.1/2	7314150363254	1	53
787-1.1/4	7314150363216	1	53
787-1.1/8	7314150363193	1	53
787-1.11/16	7314150363278	1	53
787-1.13/16	7314150363292	1	53
787-1.3/16	7314150363209	1	53
787-1.3/4	7314150363285	1	53
787-1.3/8	7314150363230	1	53
787-1.5/16	7314150363223	1	53
787-1.5/8	7314150363261	1	53
787-1.7/16	7314150363247	1	53
787-1.7/8	7314150363308	1	53
787-2	7314150363315	1	53
787-2.1/4	7314150363346	1	53
787-2.1/8	7314150363322	1	53
787-2.3/16	7314150363339	1	53
787-2.3/8	7314150363353	1	53
7888DM	7314151820923	1	77
789-1.1/2	7314150363896	1	57



789-1.1/4	7314150363858	1	57
789-1.1/8	7314150363841	1	57
789-1.13/16	7314150363933	1	57
789-1.3/4	7314150363926	1	57
789-1.3/8	7314150363872	1	57
789-1.5/16	7314150363865	1	57
789-1.5/8	7314150363919	1	57
789-1.7/16	7314150363889	1	57
789-1.9/16	7314150363902	1	57
789-2	7314150363940	1	57
789-2.1/4	7314150363957	1	57
789-2.3/8	7314150363971	1	57
789-2.5/16	7314150363964	1	57
789-28	7314150363742	1	57
789-30	7314150363759	1	57
789-32	7314150357673	1	57
789-34	7314150363766	1	57
789-36	7314150363773	1	57
789-38	7314150363780	1	57
789-40	7314150363797	1	57
789-41	7314150363803	1	57
789-42	7314150363810	1	57
789-46	7314150363827	1	57
789-50	7314150363834	1	57
7890	7314150052691	10	635
7890 CO	7314150052899	10	635
7891	7314150052714	10	635
7891 CO	7314150052905	10	635
7892	7314150052738	10	636
7892 CO	7314150291687	10	636
7893	7314150052769	10	636
7893K	7314150351428	10	636
7894	7314150197484	10	636
790450A	7314150214716	1	267
790455A	7314150214709	1	268
7993M0170	8413345115353	1	189
7993M0190	8413345115377	1	189
7993M0220	8413345115391	1	189
7993M0270	8413345115414	1	189
7993S0050	8413345115070	1	183
7993S0060	8413345115094	1	183
7993S0080	8413345115117	1	183
7993S0100	8413345115131	1	183
7993S0120	8413345115155	1	183
7993S0140	8413345115179	1	183
7993S0170	8413345115193	1	183
7993S0180	7314150476855	1	183
7993S0190	8413345115216	1	183
7993T0120	8413345115230	1	186
7993T0140	8413345115254	1	186
7993T0170	8413345115278	1	186
7993T0190	8413345115292	1	186
7993T0220	8413345115315	1	186
7993T0240	8413345115339	1	186
7994S0200	7314150492954	1	183
7994S0250	7314150492947	1	183
7994S0270	7314150492930	1	183
7994S0300	8413345129305	1	183
7994S0400	8413345129312	1	183
7994S0450	8413345129329	1	183
7994S0500	8413345129336	1	183
7994S0550	8413345129343	1	183
7994S0600	8413345129350	1	183
7994S0700	7314150522583	1	183
800-1.5-50ESD	8412243589327	10	629
800-2-50ESD	8412243589341	10	629
800-2.5-50ESD	8412243589365	10	629
800-3-50ESD	8412243589389	10	629
801-0-50ESD	8412243589426	10	629
801-00-50ESD	8412243589402	10	629
801-1-75ESD	8412243589440	10	629
801-7ESD	8412243589280	1	629
8010SL-2P	7314150243853	1	486
8020-2P	7314150246601	1	201
803-10-50ESD	8412243589648	10	629
803-15-75ESD	8412243589549	10	629
803-20-75ESD	8412243589563	10	629
803-6-50ESD	8412243589464	10	629
803-7-50ESD	8412243589488	10	629
803-7ESD	8412243589303	1	629
803-8-50ESD	8412243589501	10	629
803-9-50ESD	8412243589525	10	629
8030-2P	7314150246618	1	201
8040-2P	7314150246625	1	201
8040L-2P	7314150246670	1	202
8040SL-2P	7314150243877	1	486
8045LVDE	7314151509163	10	226
8045VDE	7314151317256	10	225
805-TS1-50ESD	8412243589587	10	629
805-TS4-50ESD	8412243589600	10	629
805-TS5-50ESD	8412243589624	10	629
8050SL-2P	7314150243884	1	486
8052	7314151318406	5	224
806-1-1	7311518003760	6	225
806-1-2	7314150183258	6	225
806-1-3	7314150183265	6	225

8069	7314150007028	5	41
8069 C	7314150007035	5	41
8069 C IP	7314150101634	5	41
8069 IP	7314150007042	50	41
8069-1	7314150239511	1	41
8069-2	7314150239590	1	41
8070	7314150007110	5	41
8070 C	7314150007127	5	41
8070 C IP	7314150101641	5	41
8070 IP	7314150007134	40	41
8070-1	7314150239528	1	41
8070-2	7314150238606	1	41
8070V	7314150121519	2	489
8070VL	7314150213511	1	489
8071	7314150007202	5	41
8071 C	7314150007219	5	41
8071 C IP	7314150101658	5	41
8071 IP	7314150007226	50	41
8071-1	7314150239535	1	41
8071-2	7314150238613	1	41
8071V	7314150121526	2	489
8071VL	7314150213535	1	489
8071VLT	7314150121564	1	489
8072	7314150007288	5	41
8072 C	7314150007295	5	41
8072 C IP	7314150101665	5	41
8072 IP	7314150007301	30	41
8072-1	7314150239542	1	41
8072-2	7314150238620	1	41
8072V	7314150121533	2	489
8072VL	7314150213542	1	489
8072VLT	7314150121571	1	489
8073	7314150007363	5	41
8073 C	7314150007370	5	41
8073 C IP	7314150101672	5	41
8073 IP	7314150007387	20	41
8073-1	7314150239559	1	41
8073-2	7314150238637	1	41
8073V	7314150121540	2	489
8073VL	7314150213559	1	489
8073VLT	7314150121588	1	489
8074	7314150007448	3	41
8074 C	7314150007455	3	41
8074 C IP	7314150101689	3	41
8074 IP	7314150007462	20	41
8074-1	7314150239566	1	41
8074-2	7314150238644	1	41
8074V	7314150121557	2	489
8075	7314150007523	3	41
8075 C	7314150007530	3	41
8075 C IP	7314150101696	3	41
8075 IP	7314150007547	10	41
8075-1	7314150239573	1	41
8075-2	7314150238651	1	41
808050	7314153017642	25	217
808050A	7314150127306	25	223
808050L	7314150128075	25	217
808050L-SP1	7314150129218	50	217
808050P	7314150128105	25	217
808050P-25	7314150165179	10	218
808050S	7314150128082	25	218
808050S-18	7314150128921	30	218
808050S-22	7314150128938	30	218
808050TORX	7314150127313	25	223
808050TS	7314150128099	25	218
808060	7314150243822	1	486
808061	7314150243839	5	486
808062	7314150243846	5	486
8110H-1/2	7314153015860	1	102
8120-1/2	7314150384884	12	102
8120-1/4	7314150384921	20	87
8120-3/8	7314150384914	10	93
813	7314150055852	1	633
8130	7314150050918	10	630
8130-50/SUPR SPRING	7314150111572	1	633
8131	7314150050925	10	630
8131 CO	7314150051519	10	630
8132	7314150050932	10	630
8133	7314150470945	10	630
8134	7314150470952	10	630
8135	7314150470969	10	630
8136	7314150470976	10	631
8137	7314150459728	10	631
8138	7314150361540	10	631
814	7314150055845	1	633
8140	7314150050949	10	630
8140 CO	7314150051533	10	630
8140M2	7314150470983	10	634
8140PS	7314150358472	10	634
8141	7314150050987	10	630
8141 CO	7314150051557	10	630
8141PS	7314150349425	10	634
8142	7314150051007	10	630
8142 CO	7314150051564	10	630
8143	7314150051021	10	630
8144	7314150051045	10	630

* Until stocks last

8144 CO	7314150051601	10	630
8145	7314150051052	10	630
8146	7314150051076	10	631
8147	7314150051083	10	631
8148	7314150051090	10	631
8148 CO	7314150051656	10	631
8149	7314150051106	10	632
8150	7314150051113	10	630
8150 CO	7314150051670	10	630
8150 J	7314150051137	10	636
8150 SK	7314150112814	10	636
8150-1/2	7314151105006	1	101
8150-1/2-SPARE	7314150187881	1	103
8150-1/2V	7314150121601	1	490
8150M2	7314150470990	10	634
8150MH	7314153024619	5	102
8150PS	7314150358489	10	634
8150QR	7314150540150	3	101
8150RN-1/2	7314151831202	1	101
8150RN-1/2-SPARE	7314150209378	1	103
8150SL	7314150197682	1	101
8150SL-SPARE	7314150210275	1	103
8151	7314150051199	10	630
8151 CO	7314150051694	10	630
8151-1/2	7314151105112	1	102
8152	7314150052097	10	630
8152-1/2	7314151105129	1	97
8153	7314150051205	10	630
8154	7314150052103	10	630
8154 CO	7314150052233	10	630
8154-1/2V	7314150121595	1	490
8154-11	7314150469161	10	98
8154PSP	7314150347704	10	634
8155	7314150052110	10	630
8155-SO/1	7314153000811	1	103
8156	7314150051212	10	631
8157	7314150052127	10	631
8157-10	7314150467273	1	97
8157-15	7314150469222	1	97
8157-24	7314150469246	1	97
8157-36	7314150469260	10	97
8158	7314150052134	10	631
8158-10	7314150471003	1	97
8158-15	7314150471010	1	97
816	7314150428182	1	633
8160	7314150051229	10	630
8160 CO	7314150051724	10	630
8160 J	7314150051250	10	636
8160 M2	7314150381906	10	634
8160-1/2V	7314150121618	1	490
8160-10	7314150469185	10	98
8160-3	7314150469208	10	98
8160-5	7314150469284	8	98
8160-B	7314150182565	1	98
8160/SPRING	7314150229888	1	633
8160PS	7314150358496	10	634
8160W-10	7314150471027	10	98
8160W-3	7314150471041	10	98
8160W-5	7314150471065	8	98
8161	7314150051328	10	630
8161 CO	7314150051748	10	630
8161PS	7314150361533	10	634
8162	7314150051335	10	630
8162-1/2V	7314150121625	1	490
8163	7314150051342	10	630
8163 CO	7314150051762	10	630
8164	7314150052141	10	630
8165	7314150052158	10	630
8165 CO	7314150052288	10	630
8166	7314150459377	10	98
8166L	7314150476350	10	631
8167	7314153003584	1	92
8167L	7314150476367	10	631
8168	7314150128440	40	98
8168L	7314150347711	10	631
8171	7314150469307	20	98
8172	7314150469321	10	99
8174A	7314150476374	10	98
8178	73141500512065	10	99
8194-1/2*	7314151831226	1	102
8195-KEY	7314150389810	50	99
8195-R	7314150389780	1	102
8195-SET	7314150389797	5	102
8195-SQ	7314150389803	25	102
8211	7314150101030	10	631
8220SL-2P	7314150243860	1	486
8223	7314150112685	4	250
8223 IP	7314150113149	4	250
8224	7314150000012	4	250
8224 IP	7314150101757	4	250
8224CIP	7314150103607	4	250
8225	7314150000029	4	250
8225 IP	7314150101764	4	250
8225CIP	7314150103614	4	250
8226	7314150115853	1	250
8231	7311518266509	4	250



8231 IP



8231 IP	7311518270285	4	250
8242-2P	7314150243686	1	201
8242L-2P	7314150246687	1	202
8247	7314150051397	10	632
8247 CO	7314150051809	10	632
8248	7314150051427	10	632
8248 CO	7314150051823	10	632
8248Q	7314150349364	10	632
8249	7314150349401	10	632
8252-2P	7314150243693	1	201
8252L-2P	7314150246694	1	202
8252XL-1P	7314150265985	1	203
833AJ-4	7311518286927	1	576
833AJ-5	7311518286934	1	576
833AJ-6	7311518286941	1	576
833FJ-4	7311518286965	1	576
833FJ-5	7311518286972	1	576
833FJ-6	7311518286989	1	576
833PJ-4	7311518286897	1	575
833PJ-5	7311518286903	1	575
833PJ-67	7311518286910	1	575
833SB-4	7311518286859	1	576
833SB-5	7311518286866	1	576
833SB-6	7311518286873	1	576
833SB-7	7311518286880	1	576
834V-2	7314150124992	1	575
834V-4	7311518286811	1	575
834V-5	7311518286828	1	575
834V-6	7311518286835	1	575
834V-7	7311518286842	1	575
84-PODGER	7314150307494	1	42
850-1	7311518292737	10	536
8501-10	7311518004828	1	147
8501-10F	7311518220945	1	147
8501-12	7311518004842	1	147
8501-12F	7311518220952	1	147
8501-13	7311518004859	1	147
8501-136-10-24C	7314150371471	1	147
8501-136-20-24C	7314150371488	1	147
8501-13F	7311518220969	1	147
8501-15	7311518004873	1	147
8501-150-10-24C	7314150403004	1	147
8501-15F	7311518220976	1	147
8501-16	7311518004880	1	147
8501-160-20-24C	7314150403011	1	147
8501-160-20-48XF	7314150402892	1	147
8501-165-20-24C	7314150403028	1	147
8501-165-20-48XF	7314150402908	1	147
8501-16F	7311518220983	1	147
8501-16SW	7314150258642	1	147
8501-17	7311518004897	1	147
8501-17F	7311518220990	1	147
8501-17S	7311518221027	1	147
8501-184-16-24	7314150402946	1	147
8501-184-16-40	7314150402953	1	147
8501-184-20-24C	7314150403042	1	147
8501-18S	7311518221034	1	147
8501-18SW	7311518221058	1	147
8501-190-30-24C	7314150403059	1	147
8501-190-30-60XF	7314150402960	1	147
8501-2	7311518004743	1	147
8501-210-30-48SW	7314150403066	1	147
8501-210-30-60XF	7314150402977	1	147
8501-216-60SW	7314150359448	1	147
8501-22	7311518178888	1	147
8501-22F	7311518221003	1	147
8501-23	7311518004958	1	147
8501-230-30-60XF	7314150402984	1	147
8501-235-30-60XF	7314150402991	1	147
8501-23F	7311518018887	1	147
8501-260-24SW	7314150359479	1	147
8501-260-30-80S	7314150403097	1	147
8501-260-40SW	7314150359462	1	147
8501-260-60SW	7314150359455	1	147
8501-28	7311518018894	1	147
8501-28F	7311518221010	1	147
8501-28S	7311518221041	1	147
8501-28SW	7311518221065	1	147
8501-28XF	7311518281946	1	147
8501-3	7311518004750	1	147
8501-30	7311518237479	1	147
8501-305-30-40SW	7314150403073	1	147
8501-305-30-60SW	7314150403080	1	147
8501-305-30-96S	7314150403103	1	147
8501-30F	7311518237462	1	147
8501-30S	7311518282240	1	147
8501-30SW	7311518282196	1	147
8501-30XF	7311518281984	1	147
8501-31	7311518237455	1	147
8501-31F	7311518237448	1	147
8501-4	7311518008079	1	147
8501-40	7311518282042	1	147
8501-4F	7311518220914	1	147
8501-4XF	7311518281786	1	147
8501-5	7311518004774	1	147
8501-5F	7311518220921	1	147



8501-7	7311518004798	1	147
8501-7F	7311518220938	1	147
8510SL-2P	7314150245758	1	486
8520SL-2P	7314150245765	1	486
86	7314150005376	1	41
86-1	7314150254996	1	41
86-2	7314150255009	1	41
8600-2P	7314150246564	1	201
8610-2P	7314150243648	1	201
8610L-2P	7314150246700	1	202
8610SL-2P	7314150243891	1	486
8620-2P	7314150243662	1	201
8620L-2P	7314150246717	1	202
8620SL-2P	7314150243907	1	486
8620XL-1P	7314150265947	1	203
8630-2P	7314150246571	1	201
8630XL-1P	7314150265961	1	203
864000010	8413345137638	1	540
864000020	7314150330171	1	541
8640002450	8413345129022	50	540
864100010	8413345137621	1	541
864102400	8413345129015	1	541
865-1	7311518292744	10	536
87	7314150005406	1	41
87-1	7314150255016	1	41
87-2	7314150255023	1	41
8703-2P	7314150246632	1	202
8704-2P	7314150246649	1	202
8705-2P	7314150246656	1	202
8706-2P	7314150246663	1	202
8710SL-2P	7314150245772	1	486
8720SL-2P	7314150245789	1	486
874002000	8413345024938	5	591
874002500	8413345024945	5	591
874003000	8413345024952	5	591
874003500	8413345024969	5	591
874004000	8413345024976	5	591
874005000	8413345024983	5	591
874102000	8413345080989	6	591
874102500	8413345081009	5	591
874103000	8413345081023	5	591
874103500	8413345081047	4	591
874104000	8413345081061	5	591
874602000	8413345024990	5	591
874602500	8413345025003	5	591
874603000	8413345025065	5	591
874603500	8413345025072	5	591
874604000	8413345025089	5	591
874916X16	7314150489787	1	592
874918X18	7314150489800	1	592
874923X13	7314150489763	1	592
874926X7	7314150489749	1	592
876002000	8413345025119	10	592
876002500	8413345025126	5	592
877002400	8413345025140	25	592
8800-2P	7314150246588	1	201
8810-2P	7314150243655	1	201
8810L-2P	7314150246724	1	202
8810SL-2P	7314150243914	1	486
8820-2P	7314150243679	1	201
8820L-2P	7314150246731	1	202
8820SL-2P	7314150243921	1	486
8820XL-1P	7314150265954	1	203
8821MB	7314150220571	1	80
8830-2P	7314150246595	1	201
8830XL-1P	7314150265978	1	203
8840M	7314151105495	1	80
8845DM	7314151105525	1	80
8845NM	7314151810955	1	79
8900DM-19	7314151105730	1	103
8900DM-21	7314150166367	5	103
8900DM-22	7314151105754	1	103
8900DM-23	7314150166374	1	103
8900DM-24	7314151105778	1	103
8900DM-25	7314151105785	1	103
8900DM-26	7314150219797	1	103
8900DM-27	7314151105822	1	103
8900DM-28	7314151105846	1	103
8900DM-29	7314150219803	1	103
8900DM-30	7314151105884	5	103
8900DM-32	7314151105891	1	103
8900DM-33	7314150166398	1	103
8900DM-34	7314151838478	1	103
8900DM-35	7314150219810	1	103
8900DM-36	7314151105914	1	103
8900DM-37	7314150166404	1	103
8900DM-38	7314150219827	1	103
8900DM-40	7314150166411	1	103
8900DM-41	7314151105938	5	103
8900DM-42	7314150166428	1	103
8900DM-46	7314151105952	1	103
8900DM-47	7314150166435	1	103
8900DM-50	7314151105969	5	103
8900DM-52	7314150166442	1	103
8900DM-54	7314150166459	3	103
8900DM-55	7314151105983	1	103



8900DM-56	7314150166466	1	103
8900DM-60	7314151106003	5	103
8900DZ-1	7314151106058	1	104
8900DZ-1.1/16	7314151106065	1	104
8900DZ-1.1/2	7314151106133	1	104
8900DZ-1.1/4	7314151106096	1	104
8900DZ-1.1/8	7314151106072	1	104
8900DZ-1.11/16	7314150166282	1	104
8900DZ-1.13/16	7314151106188	1	104
8900DZ-1.3/16	7314151106089	1	104
8900DZ-1.3/4	7314151106171	1	104
8900DZ-1.3/8	7314151106119	1	104
8900DZ-1.5/16	7314151106102	5	104
8900DZ-1.5/8	7314151106157	1	104
8900DZ-1.7/16	7314151106126	1	104
8900DZ-1.7/8	7314151106195	1	104
8900DZ-1.9/16	7314150166299	1	104
8900DZ-13/16	7314150166305	1	104
8900DZ-15/16	7314151106034	1	104
8900DZ-2	7314151106201	1	104
8900DZ-2.1/16	7314150166312	1	104
8900DZ-2.1/4	7314150166329	1	104
8900DZ-2.1/8	7314150166336	1	104
8900DZ-2.3/16	7314150358670	1	104
8900DZ-2.3/8	7314150166350	1	104
8900DZ-3/4	7314150166381	1	104
8900DZ-31/32	7314150358663	1	104
8900DZ-7/8	7314150166473	1	104
8900SM-19	7314150166633	1	103
8900SM-22	7314151810795	1	103
8900SM-23	7314150219834	1	103
8900SM-24	7314151810801	5	103
8900SM-26	7314150219841	5	103
8900SM-27	7314151810818	5	103
8900SM-28	7314150166657	1	103
8900SM-29	7314150219858	1	103
8900SM-30	7314151810825	5	103
8900SM-32	7314151810832	5	103
8900SM-33	7314150166671	1	103
8900SM-34	7314151838461	1	103
8900SM-35	7314150166688	1	103
8900SM-36	7314151810849	5	103
8900SM-38	7314151810856	1	103
8900SM-41	7314151810863	5	103
8900SM-42	7314150219865	1	103
8900SM-46	7314151810870	1	103
8900SM-50	7314151810887	1	103
8900SM-55	7314151810894	1	103
8900SM-60	7314151810900	1	103
8900SZ-1*	7314150166480	1	103
8900SZ-1.7/16*	7314150166589	1	103
8900SZ-1.7/8*	7314150166596	1	103
8900SZ-1.9/16*	7314150166602	1	103
8900SZ-13/16*	7314150166619	1	103
8900SZ-2*	7314150166640	1	103
8900SZ-3/4*	7314150166664	1	103
89049TM-1000	7314150415403	1	119
8905-TM	7314150125470	1	120
8910-2P	7314150243709	1	202
8910SL-2P	7314150243938	1	486
8915-2P	7314150243716	1	202
8915L-2P	7314150258765	1	202
8915SL-2P	7314150243945	1	486
8920-2P	7314150243723	1	202
8920L-2P	7314150258772	1	202
8920SL-2P	7314150243952	1	486
89222CR-1000	7314150415441	1	120
8925-2P	7314150243730	1	202
8925L-2P	7314150258789	1	202
8925SL-2P	7314150243969	1	486
8927-2P	7314150243747	1	202
8927L-2P	7314150263516	1	202
8930-2P	7314150243754	1	202
8930L-2P	7314150258796	1	202
8930SL-2P	7314150243976	1	486
8940-2P	7314150243761	1	202
894M-10	7314151833039	10	53
894M-100	7314151833305	1	53
894M-105	7314151833312	1	53
894M-11	7314151833046	10	53
894M-110	7314151833329	1	53
894M-115	7314151833336	1	53
894M-12	7314151833053	10	53
894M-120	7314151833343	1	53
894M-125	7314150132478	1	53
894M-13	7314151833060	10	53
894M-130	7314150132485	1	53
894M-135	7314150132492	1	53
894M-14	7314151833077	10	53
894M-15	7314151833084	10	53
894M-16	7314150139569	10	53
894M-17	7314151833091	10	53
894M-19	7314151833107	10	53
894M-21	7314150223220	5	53
894M-22	7314151833114	5	53
894M-24	7314151833121	5	53

* Until stocks last



894M-27	7314151833138	5	53
894M-30	7314151833145	5	53
894M-32	7314151833152	5	53
894M-34	7314150139583	1	53
894M-36	7314151833169	5	53
894M-38	7314151833176	1	53
894M-41	7314151833183	1	53
894M-46	7314151833190	1	53
894M-50	7314151833206	1	53
894M-55	7314151833213	1	53
894M-60	7314151833220	1	53
894M-65	7314151833237	1	53
894M-7	7314151833008	10	53
894M-70	7314151833244	1	53
894M-75	7314151833251	1	53
894M-8	7314151833015	10	53
894M-80	7314151833268	1	53
894M-85	7314151833275	1	53
894M-9	7314151833022	10	53
894M-90	7314151833282	1	53
894M-95	7314151833299	1	53
8950NA-SO/2*	7314151816605	1	105
8950RN	7314150522675	1	105
8950RNA	7314150521258	1	105
8951	7314151106782	1	105
8951-M	7314150124916	1	121
8953-16	7314150538300	1	104
8953E-32	7314150509447	1	104
8954-15	7314150522774	1	104
8954A	7314151106812	1	104
8955N	7314150434114	1	105
8955N-SPARE	7314150434121	1	105
8955N/A	7314150434053	1	105
8955N/B	7314150434176	5	105
8957-19	7314150522781	1	104
8957A	7314150510580	1	104
8958A*	7314151106836	1	104
895M-10-11	7314151832742	10	51
895M-10-13	7314151832759	10	51
895M-13-17	7314151832803	10	51
895M-17-19	7314151832827	10	51
895M-19-22	7314151832834	10	51
895M-19-24	7314151832841	5	51
895M-22-24	7314151832858	5	51
895M-24-27	7314151832865	5	51
895M-24-30	7314151832872	5	51
895M-27-32	7314151832889	5	51
895M-30-32	7314151832896	5	51
895M-30-36	7314151832902	1	51
895M-32-36	7314151832919	1	51
895M-36-41	7314151832926	1	51
895M-41-46	7314151832933	1	51
895M-46-50	7314151832940	1	51
895M-50-55	7314151832957	1	51
895M-55-60	7314151832964	1	51
895M-6-7	7314151832711	10	51
895M-65-70	7314151832971	1	51
895M-8-10	7314151832735	10	51
895M-8-9	7314151832728	10	51
8960-16	7314150492855	12	104
8960-8	7314150492862	1	104
8963	7314150181087	1	104
8966	7314151106898	1	104
8967	7314153003591	1	99
8967/S3	7314153003607	1	85
8971	7314150492879	1	105
8972	7314150492886	1	105
9-12-51/3806-KP	7311518044558	5	619
9-462-14-0-0*	7311518020873	5	37
9-467-00-0-0	7311518020897	1	37
9-469-00-0-0	7311518020903	1	37
9-484-3.2-10	7311518193348	10	37
9-484-3.2-1P	7311518193522	10	37
9-484-5.2-10	7311518193355	10	37
9-484-5.2-1P	7311518193331	10	37
9-485-04-10	7314150271672	10	37
9-485-04-1P	7314150271665	10	37
9-485-05-10	7314150271696	10	37
9-485-05-1P	7314150271689	10	37
9-485-06-10	7311518193508	10	37
9-485-06-1P	7311518193492	20	37
9-485-09-10	7311518193386	10	37
9-485-09-1P	7311518193362	20	37
9-485-13-10	7311518193393	10	37
9-485-13-1P	7311518193379	1	37
9-486-04-10	7311518193430	10	38
9-486-04-1P	7311518193409	20	38
9-486-05-10	7311518193461	10	38
9-486-05-1P	7311518193447	20	38
9-486-07-10	7311518249373	10	38
9-486-07-1P	7311518249359	20	38
9-486-08-10	7311518270933	10	38
9-486-C-10	7311518209599	10	38
9-486-C-1P	7311518209605	10	38
9-488-02-10	7311518194772	10	37
900T-020-100	7314153018106	5	222



900T-025-100



900T-025-100	7314153018113	5	222
900T-030-100	7314153018120	5	222
900T-040-150	7314153018137	5	222
900T-050-150	7314153018144	5	222
900T-060-200	7314153018151	5	222
900T-080-200	7314153018168	5	222
900T-100-200	7314153018175	5	222
901T-006-100	7314153018182	5	222
901T-007-100	7314153018199	5	222
901T-008-100	7314153018205	5	222
901T-009-100	7314153018212	5	222
901T-010-100	7314153018229	5	222
901T-015-150	7314153018236	5	222
901T-020-150	7314153018243	5	222
901T-025-150	7314153018250	5	222
901T-027-150	7314153018267	5	222
901T-030-200	7314153018274	5	222
901T-040-200	7314153018281	5	223
901T-045-200	7314153018298	5	223
901T-050-200	7314153018304	5	223
9029	7314153010612	5	40
9029 C	7314153010629	5	40
9029-1	7314150239580	1	41
9029-2	7314150238668	1	41
9029-T	7314150189076	5	40
9029T-1	7314150312139	1	41
902T-050-150	7314153018311	5	223
902T-055-150	7314153018328	5	223
902T-060-150	7314153018335	5	223
902T-070-175	7314153018342	5	223
902T-080-175	7314153018359	5	223
902T-090-175	7314153018366	5	223
902T-100-175	7314153018373	5	223
902T-110-175	7314153018380	5	223
902T-120-175	7314153018397	5	223
902T-130-175	7314153018403	5	223
9031	7314150110988	5	40
9031 C	7314150113507	5	40
9031 P-1	7314150266302	1	41
9031-1	7314150239597	1	41
9031-8224	7314150321193	3	261
9031-T	7314150131648	5	40
9031P	7314150187539	5	40
9031T-1	7314150312146	1	41
9033	7314150181414	5	40
9033-1	7314150353804	1	41
9035	7314150181421	5	40
9035-1	7314150353811	1	41
903T-1	7314153018410	1	222
903T-2	7314153018427	1	222
903T-3	7314153018434	1	222
9045-B-200	7311518012175	6	532
9045-B-250	7311518012182	6	532
9045-B-300	7311518012199	6	532
9045-B-400	7311518178123	1	532
9048-200	7314150138159	10	532
9048-250	7314150138166	10	532
9048-300	7314150138173	10	532
9048-350	7314150180349	10	532
9048-400	7314150138180	10	532
904T-060-150	7314153019837	5	223
905T-060-100	7314153019844	5	223
9060	7314150545247	1	628
9061	7314150545254	1	628
9070	7314150100170	5	40
9070 P	7314150103416	5	40
9070 P-1	7314150239610	1	41
9070 PC	7314150103423	5	40
9070C	7314150100187	5	40
9071	7314150100194	5	40
9071 P	7314150103430	5	40
9071 P-1	7314150239627	1	41
9071 PC	7314150103447	5	40
9071C	7314150100200	5	40
9072	7314150055609	5	40
9072 C	7314150055616	5	40
9072 P	7314150056354	5	40
9072 P-1	7314150239634	1	41
9072 PC	7314150056361	5	40
9073	7314150101702	5	40
9073 C	7314150101719	3	40
9073 P	7314150101726	5	40
9073 P-1	7314150239641	1	41
9073 PC	7314150101733	3	40
91-023-5P	7311518032593	1	144
91-027-5P	7311518032616	1	144
91-143-100P	7311518224363	1	144
91-143-25P	7311518266578	1	144
91-143-5P	7311518032630	1	144
91-148-5P	7311518032654	1	144
91-223-5P	7311518032661	1	144
91-226-5P	7311518032685	1	144
91-233-5P	7311518260057	1	144
91-243-5P	7311518032692	1	144
91-2PW-5P	7311518260163	1	144
91-3PM-5P	7311518260156	1	144



91-412-5P	7311518260040	1	144
91-433-5P	7311518260101	1	144
91-434-5P	7311518260026	1	144
91-443-5P	7311518032722	1	144
91-444-5P	7311518260033	1	144
91-4PWM-5P	7311518260170	1	144
91-502-5P	7311518032746	1	144
91-512-25P	7311518266592	1	144
91-512-5P	7311518032753	1	144
91-517-5P	7311518032777	1	144
91-522-5P	7311518032784	1	144
91-611-5P	7311518260071	1	144
91-612-5P	7311518032814	1	144
91-622-5P	7311518260088	1	144
91-623-5P	7311518260064	1	144
91-7V1-5P	7311518260118	1	144
91-METAL-10P	7314150449477	1	144
91-MIXED-10P	7314150449491	1	144
91-WOOD-10P	7314150449446	1	144
91C	7314150182381	5	42
92-001-1P	7314150474998	90	146
92-106-1P	7314150474899	90	145
92-113-1P	7314150474912	90	145
92-118-1P	7314150474950	90	146
92-133-1P	7314150474134	70	144
92-133-25P	7314150539246	1	144
92-133-3P	7314150474158	46	144
92-136-1P	7314150474783	20	146
92-136-G120-5P	7314150498079	10	146
92-136-G240-5P	7314150498116	10	146
92-136-G40-5P	7314150497997	10	146
92-136-G80-5P	7314150498031	10	146
92-137-1P	7314150475070	50	146
92-137-G120-5P	7314150498093	10	146
92-137-G240-5P	7314150498130	10	146
92-137-G40-5P	7314150498017	10	146
92-137-G80-5P	7314150498055	10	146
92-151-25P	7314150539345	1	145
92-152-25P	7314150539352	1	145
92-157-1P	7314150474820	70	145
92-157-25P	7314150539314	1	145
92-160-1P	7314150474172	70	145
92-160-25P	7314150539253	1	145
92-160-3P	7314150474196	46	145
92-165-1P	7314150475018	90	146
92-166-1P	7314150474974	50	146
92-174-1P	7314150474936	90	145
92-205-1P	7314150474219	70	144
92-205-25P	7314150539277	1	144
92-205-3P	7314150474356	46	144
92-221-1P	7314150474721	70	145
92-222-1P	7314150474592	70	145
92-222-25P	7314150539284	1	145
92-222-3P	7314150474370	46	145
92-223-1P	7314150474684	70	145
92-223-25P	7314150539321	1	145
92-223-3P	7314150474400	46	145
92-225-1P	7314150474707	70	144
92-225-25P	7314150539291	1	144
92-226-1P	7314150475032	90	146
92-228-1P	7314150474745	70	145
92-228-25P	7314150539307	1	145
92-229-1P	7314150474769	70	144
92-236-1P	7314150474806	70	145
92-236-25P	7314150539338	1	145
92-245-1P	7314150475056	90	146
92-251-1P	7314150474868	70	146
92-WM-SET-8P	7314150486830	34	146
9210	7311518278182	1	624
9210-1	7311518278212	1	624
9210-10	7311518278229	1	624
9210-1060177	7311518295424	1	625
9210-1060238	7311518295394	20	625
9210-1230219	7311518295387	20	625
9210-1230235	7311518295325	1	624
9210-1320281	7311518295431	10	625
9210-1640142	7311518295356	1	624
9210-1690148	7311518295332	1	624
9210-1700118	7311518295363	1	625
9210-1710266	7311518295417	1	625
9210-1720100	7311518295295	1	624
9210-1730107	7311518295349	10	624
9210-1770106	7311518295370	10	625
9210-1830137	7311518295400	1	625
9210-20	7311518278236	1	624
92C	7314150182398	5	42
93C	7314150182404	5	42
94C	7314150182411	5	42
9500DZ-1.13/16	7314150227501	1	106
9500DZ-1.5/8	7314150227495	1	106
9500DZ-1.7/8	7314150227518	1	106
9500DZ-2	7314150227525	1	106
9500DZ-2.1/2	7314150227570	1	106
9500DZ-2.1/4	7314150227556	1	106
9500DZ-2.1/8	7314150227532	1	106
9500DZ-2.15/16	7314150227617	1	106



9500DZ-2.3/16	7314150227549	1	106
9500DZ-2.3/4	7314150227600	1	106
9500DZ-2.3/8	7314150227563	1	106
9500DZ-2.5/8	7314150227594	1	106
9500DZ-2.9/16	7314150227587	1	106
9500DZ-3	7314150227624	1	106
9500DZ-3.1/8	7314150227631	1	106
9500SM-41	7314153013699	1	106
9500SM-46	7314153013705	1	106
9500SM-50	7314153013712	1	106
9500SM-54	7314153013729	1	106
9500SM-55	7314153013736	1	106
9500SM-58	7314153013743	1	106
9500SM-60	7314153013750	1	106
9500SM-63	7314153013767	1	106
9500SM-65	7314153013774	1	106
9500SM-67	7314153013781	1	106
9500SM-70	7314153013798	1	106
9500SM-71	7314153013804	1	106
9500SM-75	7314153013811	1	106
9500SM-77	7314153013828	1	106
9500SM-80	7314153013835	1	106
9500SM-82	7314153013842	1	106
9505-3400	7314150125517	1	120
9505-TM	7314150125487	1	120
95155B-3000	7314150415410	1	120
9525-10	7311518031817	1	162
9525-3400	7314150125524	1	120
9525-7	7311518031800	1	162
9525CR-4000	7314150415465	1	120
9526B-4500	7314150415427	1	120
9527CR-2000	7314150415458	1	120
9540DZ	7314150414048	1	80
9540DZL	7314150414055	1	81
9540MB	7314153014108	1	80
9540MBL	7314153014115	1	80
9550N	7314150424160	1	106
9550N-SPARE	7314150424153	1	107
9550N/A	7314150424146	1	107
9550N/B	7314150424788	1	106
9555	7314153014047	1	106
9555AB	7314153014061	1	106
956	7314150025190	1	560
9560AB	7314153014078	1	106
9563AB	7314153014085	1	106
9565AB	7314153014092	1	106
9572*	7314150178599	5	42
9572-200	7311518004231	20	532
9572-250	7311518004248	20	532
9574-200	7314150138197	10	532
9574-250	7314150138203	10	532
9574-300	7314150180356	10	532
9575-250	7314150185894	6	532
95C	7314150182428	1	42
960100010	8413345031073	1	448
960100020	8413345031080	1	448
960100030	8413345031097	1	448
960100050	8413345031103	1	448
960100060	8413345031110	1	448
9625-6.35QC	7314150441716	1	162
9625-9500	7314150125555	1	120
96255CR-7000	7314150415489	1	120
9626-10	7314150388844	1	160
9626-11	7314150388851	1	160
9626-12	7314150388868	1	160
9626-13	7314150388875	1	160
9626-14	7314150388882	1	160
9626-15	7314150444526	1	160
9626-16	7314150388899	1	160
9626-18	7314150388905	1	160
9626-20	7314150388912	1	160
9626-22	7314150388929	1	160
9626-23	7314150388936	1	160
9626-24	7314150388943	1	160
9626-25	7314150388950	1	160
9626-26	7314153024237	1	160
9626-28	7314150388967	1	160
9626-30	7314150388974	1	160
9626-32	7314150388981	1	160
9626-35	7314150444533	1	160
9626-6	7314150388806	1	160
9626-7	7314150388813	1	160
9626-8	7314150388820	1	160
9626-9	7314150388837	1	160
9627-10-460	7314150389018	1	160
9627-12-460	7314150389025	1	160
9627-14-460	7314150389032	1	160
9627-16-460	7314150389049	1	160
9627-18-460	7314150389056	1	160
9627-20-460	7314150389063	1	160
9627-22-460	7314150389070	1	160
9627-24-460	7314150389087	1	160
9627-26-460	7314150389094	1	160
9627-28-460	7314150389100	1	160
9627-30-460	7314150389117	1	160
9627-32-460	7314150389124	1	160

* Until stocks last



9627-6-460	7314150388998	1	160
9627-8-460	7314150389001	1	160
9629-10	7314150388479	1	161
9629-12	7314150388486	1	161
9629-13	7314150440238	1	161
9629-14	7314150388493	1	161
9629-16	7314150388509	1	161
9629-17	7314150440245	1	161
9629-18	7314150388516	1	161
9629-19	7314150440252	1	161
9629-20	7314150388523	1	161
9629-22	7314150388530	1	161
9629-24	7314150388547	1	161
9629-25	7314150388554	1	161
9629-26	7314150388561	1	161
9629-28	7314150388578	1	161
9629-30	7314150388585	1	161
9629-32	7314150388592	1	161
9629-35	7314150440269	1	161
9629-36	7314150388608	1	161
9629-38	7314150388615	1	161
9629-40	7314150388622	1	161
9629-6	7314150388417	1	161
9629-8	7314150388462	1	161
9629-SET-8	7314150441648	12	161
9631-10-400	7314150388684	1	161
9631-12-400	7314150388691	1	161
9631-13-400	7314150447572	1	161
9631-14-400	7314150388707	1	161
9631-16-400	7314150388714	1	161
9631-18-400	7314150388721	1	161
9631-19-400	7314150447589	1	161
9631-20-400	7314150388738	1	161
9631-22-400	7314150388745	1	161
9631-24-400	7314150388752	1	161
9631-25-400	7314150432066	1	161
9631-28-400	7314150388776	1	161
9631-30-400	7314150388783	1	161
9631-32-400	7314150388790	1	161
9631-35-400	7314150447596	1	161
9631-38-400	7314150447602	1	161
9631-6-400	7314150388646	1	161
9631-8-400	7314150388677	1	161
9646-10	7314150388264	1	161
9646-10-250	7314150388387	1	161
9646-11	7314150388288	1	161
9646-12	7314150388295	1	161
9646-12-250	7314150388400	1	161
9646-13	7314150388301	1	161
9646-14	7314150388318	1	161
9646-15	7314150388325	1	161
9646-16	7314150388332	1	161
9646-18	7314150388349	1	161
9646-20	7314150388356	1	161
9646-3	7314150388189	1	161
9646-4	7314150388202	1	161
9646-5	7314150388219	1	161
9646-6	7314150388226	1	161
9646-6-250	7314150388363	1	161
9646-7	7314150388233	1	161
9646-8	7314150388240	1	161
9646-8-250	7314150388370	1	161
9646-9	7314150388257	1	161
9646-SET-5	7314150441686	1	161
9646-SET-8	7314150441693	1	161
9656-SET-6	7314150486953	1	161
9666-10-400	7314150540303	1	160
9666-10-600	7314150540389	1	160
9666-12-400	7314150540310	1	160
9666-12-600	7314150540396	1	160
9666-14-400	7314150540327	1	160
9666-14-600	7314150540402	1	160
9666-16-400	7314150540334	1	160
9666-16-600	7314150540419	1	160
9666-20-400	7314150540341	1	160
9666-20-600	7314150540426	1	160
9666-22-400	7314150540358	1	160
9666-22-600	7314150540433	1	160
9666-6-400	7314150540280	1	160
9666-6-600	7314150540365	1	160
9666-8-400	7314150540297	1	160
9666-8-600	7314150540372	1	160
96C	7314150134120	1	42
97-1	7314150366637	1	123
97-1/2	7314150366645	1	123
97-1/4	7314150366650	1	123
97-10	7314150366286	1	123
97-11	7314150366293	1	123
97-11/16	7314150366583	1	123
97-12	7314150366309	1	123
97-13	7314150366316	1	123
97-13/16	7314150366606	1	123
97-14	7314150366323	1	123
97-15	7314150366330	1	123
97-15/16	7314150366620	1	123
97-16	7314150366347	1	123





97-17	7314150366354	1	123
97-17/32	7314150366552	1	123
97-18	7314150366361	1	123
97-19	7314150366378	1	123
97-21	7314150366385	1	123
97-22	7314150349722	1	123
97-24	7314150357048	1	123
97-27	7314150366392	1	123
97-3/4	7314150366590	1	123
97-3/8	7314150366521	1	123
97-30	7314150366408	1	123
97-32	7314150366415	1	123
97-5/16	7314150366514	1	123
97-5/8	7314150366576	1	123
97-7	7314150366255	1	123
97-7/16	7314150366538	1	123
97-7/8	7314150366613	1	123
97-8	7314150366262	1	123
97-9	7314150366279	1	123
97-9/16	7314150366569	1	123
9710-10-175	7314151785789	5	223
9710-3-5-75	7314151785192	10	223
9710-5-5-100	7314151785352	10	223
9710-6-5-125	7314151785437	10	223
9710-8-150	7314151785512	5	223
9710/S6	7314151802301	1	224
9715-14-250	7314153010148	5	225
9733	7314150103256	1	261
9778-1	7314151793524	10	224
9778-2	7314151793531	10	224
9778-3	7314151793548	5	224
9778PZD-1	7314151823535	10	224
9778PZD-2	7314151823542	10	224
97C	7314150128211	1	42
98-1/2	7314150367481	1	124
98-1/4	7314150367443	1	124
98-10	7314150367320	1	124
98-11	7314150367337	1	124
98-11/16	7314150367511	1	124
98-12	7314150367344	1	124
98-13	7314150367351	1	124
98-13/16	7314150367535	1	124
98-14	7314150367368	1	124
98-15	7314150367375	1	124
98-16	7314150367382	1	124
98-17	7314150367399	1	124
98-18	7314150367405	1	124
98-19	7314150367412	1	124
98-21	7314150367429	1	124
98-22	7314150367436	1	124
98-3/4	7314150367528	1	124
98-3/8	7314150367467	1	124
98-5/16	7314150367450	1	124
98-5/8	7314150367504	1	124
98-7	7314150367290	1	124
98-7/16	7314150367474	1	124
98-7/8	7314150367542	1	124
98-8	7314150367306	1	124
98-9	7314150367313	1	124
98-9/16	7314150367498	1	124
981001100	7314150219902	1	436
982000170	7314150219926	1	450
982000320	7314150219919	1	451
982000350	7314150219933	1	451
983000320	7314150219940	1	429
983100320	7314150219964	1	429
984010320	7314150219971	1	429
9841	7314150107445	1	452
9848	7314150111015	1	451
98505*	7314150216321	5	221
9852	7314150114092	1	452
9853	7314150103287	1	262
9855	7314150111848	1	637
9857	7314150114283	1	637
9858	7314150111862	1	637
9859	7314150113057	1	637
9860	7314150522859	1	637
9861	7314150522873	1	638
9862	7314150522897	1	638
9863	7314150522910	1	638
9873	7314150058082	1	261
9883	7314150043293	1	559
9897	7314150058068	1	262
9897G/3	7314150470020	1	262
9897S/3	7314150470044	1	491
99-1/2	7314150368150	1	124
99-10	7314150368013	1	125
99-11	7314150368020	1	125
99-11/16	7314150368181	1	124
99-12	7314150368037	1	125
99-13	7314150368044	1	125
99-14	7314150368051	1	125
99-16	7314150368068	1	125
99-17	7314150368075	1	125
99-18	7314150368082	1	125
99-19	7314150368099	1	125



99-21	7314150368105	1	125
99-22	7314150368112	1	125
99-24	7314150368129	1	125
99-3/4	7314150368198	1	124
99-3/8	7314150368136	1	124
99-5/8	7314150368174	1	124
99-7/16	7314150368143	1	124
99-9/16	7314150368167	1	124
9938	7314150056491	1	255
9A-14	7314150368204	1	125
9B-1/4	7314150366071	1	122
9B-5/16	7314150366088	1	122
9F-1/2	7314150366194	1	122
9F-1/4	7314150366170	1	122
9F-3/8	7314150366187	1	122
9P-1/2	7314150366057	1	122
9P-1/4	7314150366033	1	122
9P-3/8	7314150366040	1	122
9Q-1/2	7314150366019	1	122
9Q-1/4	7314150365999	1	122
9Q-3/8	7314150366002	1	122
9R-1/2	7314150365913	1	121
9R-1/4	7314150365890	1	121
9R-3/8	7314150365906	1	121
9T-1/2	7314150366118	1	122
9T-1/4	7314150366095	1	122
9T-3/8	7314150366101	1	122
9W	7314150354399	1	125
A0313M03	7311518023706	1	149
A0313M03E	7311518192150	1	149
A0313M03X	7311518182038	1	149
A0313M03XE	7311518181475	1	149
A0313M03XE-60	7311518184513	1	149
A0313M03XE-80	7311518201357	1	149
A0314I03	7314150501243	5	153
A0613M03X	7311518197872	1	149
A0616AL06E	7311518181802	1	151
A0616M06	7311518023737	1	149
A0616M06E	7311518023751	1	149
A0616M06X	7311518023768	1	149
A0616M06XE	7311518181468	1	149
A0618I06	7314150501267	5	153
A0618S06E	7314150501786	5	152
A0625M06X	7311518197780	1	152
A0820M06	7311518023805	1	149
A0820M06E	7311518023829	1	149
A0820M06X	7311518023836	1	149
A0820M06XE	7311518181994	1	149
A1020I06	7314150501304	5	153
A1020M06	7311518023874	1	149
A1020M06E	7311518023898	1	149
A1020M06X	7311518023904	1	149
A1020M06XE	7311518182007	1	149
A1020S06	7314150501335	5	152
A1020S06E	7314150501793	5	152
A1225AL06E	7311518187620	1	151
A1225AL08E	7311518181819	1	151
A1225I06	7314150506729	5	153
A1225M06	7311518023942	1	149
A1225M06E	7311518023966	1	149
A1225M06X	7311518023973	1	149
A1225M08	7311518100506	1	149
A1225M08E	7311518100520	1	149
A1225M08X	7311518187989	1	149
A1225M08XE	7311518192174	1	149
A1225S06	7314150501427	5	152
A1225S06E	7314150501809	5	152
A1625AL08XE	7311518244033	1	151
A1625M06	7311518192181	1	149
A1625M06X	7311518187361	1	149
A1625M06XE	7311518187354	1	149
A1625M08	7311518100568	1	149
A1625M08E	7311518100582	1	149
A1625M08X	7311518100599	1	149
A1625M08XE	7311518182021	1	149
A6700DM-10	7314151821722	5	82
A6700DM-11	7314151821739	5	82
A6700DM-12	7314151821746	5	82
A6700DM-13	7314151821753	5	82
A6700DM-14	7314151821760	5	82
A6700DM-4	7314150557080	5	82
A6700DM-4.5	7314150557103	5	82
A6700DM-5	7314150220632	5	82
A6700DM-5.5	7314151821678	5	82
A6700DM-6	7314151821685	5	82
A6700DM-7	7314151821692	5	82
A6700DM-8	7314151821708	5	82
A6700DM-9	7314151821715	5	82
A6700DZ-1/2	7314151751883	5	82
A6700DZ-1/4	7314151751371	5	82
A6700DZ-11/32	7314151819842	5	82
A6700DZ-3/16	7314151751029	5	82
A6700DZ-3/8	7314151751616	5	82
A6700DZ-5/16	7314151751531	5	82
A6700DZ-7/16	7314151819859	5	82
A6700DZ-7/32	7314151751296	5	82



A6700DZ-9/16	7314151751968	5	82
A6700DZ-9/32	7314151751456	5	82
A6709M-2.5	7314151753740	1	86
A6709M-3	7314151753825	1	86
A6709M-4	7314151754129	1	86
A6709M-5	7314151754471	1	86
A6709M-6	7314151754556	1	86
A6709MZ/9	7314150512096	1	70
A6709Z-1/8	7314151755447	1	86
A6709Z-3/16	7314151755874	1	86
A6709Z-5/32	7314151755799	1	86
A6709Z-9/64	7314151755522	1	86
A6710DM-10	7314151756765	1	83
A6710DM-11	7314151756840	1	83
A6710DM-12	7314151756925	1	83
A6710DM-13	7314151757069	1	83
A6710DM-14	7314151757144	1	83
A6710DM-5.5	7314151756178	1	83
A6710DM-6	7314151756253	1	83
A6710DM-7	7314151756338	1	83
A6710DM-8	7314151756413	1	83
A6710DM-9	7314151756680	1	83
A6710DZ-1/2	7314151820466	1	83
A6710DZ-1/4	7314151757229	1	83
A6710DZ-11/32	7314151757571	1	83
A6710DZ-3/16	7314151820435	1	83
A6710DZ-3/8	7314151757656	1	83
A6710DZ-5/16	7314151757496	1	83
A6710DZ-7/16	7314151757731	1	83
A6710DZ-7/32	7314151820442	1	83
A6710DZ-9/16	7314151820473	1	83
A6710DZ-9/32	7314151820459	1	83
A6716DM	7314151820824	1	67
A6716DZ	7314151820831	1	70
A6718DZ	7314150312450	1	70
A6800DM-10	7314151821845	1	82
A6800DM-11	7314151821852	1	82
A6800DM-12	7314151821869	1	82
A6800DM-13	7314151821876	1	82
A6800DM-14	7314151821883	1	82
A6800DM-4	7314151821777	1	82
A6800DM-5	7314151821784	1	82
A6800DM-5.5	7314151821791	1	82
A6800DM-6	7314151821807	1	82
A6800DM-7	7314151821814	1	82
A6800DM-8	7314151821821	1	82
A6800DM-9	7314151821838	1	82
A6800DZ-1/2	7314151758899	1	83
A6800DZ-1/4	7314151758387	1	83
A6800DZ-11/32	7314151803872	1	83
A6800DZ-3/16	7314151758035	1	83
A6800DZ-3/8	7314151758622	1	83
A6800DZ-5/16	7314151758547	1	83
A6800DZ-7/16	7314151803889	1	83
A6800DZ-7/32	7314151758110	1	83
A6800DZ-9/16	7314151758974	1	83
A6800DZ-9/32	7314151758462	1	83
A6800SM-10	7314150360147	1	82
A6800SM-11	7314150360154	1	82
A6800SM-12	7314150360161	1	82
A6800SM-13	7314150360178	1	82
A6800SM-14	7314150360185	1	82
A6800SM-15	7314150360192	1	82
A6800SM-4	7314150360208	1	82
A6800SM-4.5	7314150360215	1	82
A6800SM-5	7314150360222	1	82
A6800SM-6	7314150360239	1	82
A6800SM-7	7314150360246	1	82
A6800SM-8	7314150360253	1	82
A6800SM-9	7314150360260	1	82
A6800SZ-1/8*	7314150360277	1	83
A6800SZ-5/32*	7314150360284	1	83
A7400DM-10	7314151819972	5	88
A7400DM-11	7314151819989	5	88
A7400DM-12	7314151819996	5	88
A7400DM-13	7314151820008	5	88
A7400DM-14	7314151820015	5	88
A7400DM-15	7314151820022	5	88
A7400DM-16	7314151820039	5	88
A7400DM-17	7314151820046	5	88
A7400DM-18	7314151820053	5	88
A7400DM-19	7314151820060	5	88
A7400DM-20	7314151820077	5	88
A7400DM-21	7314151820084	5	88
A7400DM-22	7314151820091	5	88
A7400DM-24	7314150386123	5	88
A7400DM-6	7314150118212	5	88
A7400DM-7	7314150118229	5	88
A7400DM-8	7314150118236	5	88
A7400DM-9	7314151819965	5	88
A7400DZ-1/2	7314151759780	5	89
A7400DZ-1/4	7314151759193	5	89
A7400DZ-11/16	7314151819897	5	89
A7400DZ-13/16	7314151819910	5	89
A7400DZ-17/32	7314151819866	5	89
A7400DZ-19/32	7314151819873	5	89

* Until stocks last



A7400DZ-3/4	7314151819903	5	89
A7400DZ-3/8	7314151759438	5	89
A7400DZ-5/16	7314151759278	5	89
A7400DZ-5/8	7314151819880	5	89
A7400DZ-7/16	7314151759513	5	89
A7400DZ-7/8	7314151819927	5	89
A7400DZ-9/16	7314151759865	5	89
A7402DM-10	7314151820138	5	89
A7402DM-11	7314151820145	1	89
A7402DM-12	7314151820152	1	89
A7402DM-13	7314151820169	1	89
A7402DM-14	7314151820176	1	89
A7402DM-15	7314151820183	1	89
A7402DM-16	7314151820190	1	89
A7402DM-17	7314151820206	1	89
A7402DM-18	7314151820213	1	89
A7402DM-19	7314151820220	1	89
A7402DM-21	7314150385881	1	89
A7402DM-7	7314150220243	1	89
A7402DM-8	7314150220250	1	89
A7402DM-9	7314150220267	1	89
A7402DZ-1/2	7314151760526	1	90
A7402DZ-1/4	7314151759940	1	90
A7402DZ-11/16	7314151820114	1	90
A7402DZ-13/16	7314153003027	1	90
A7402DZ-19/32	7314153003041	1	90
A7402DZ-3/4	7314151820121	1	90
A7402DZ-3/8	7314151760366	1	90
A7402DZ-5/16	7314151760014	1	90
A7402DZ-5/8	7314151820107	1	90
A7402DZ-7/16	7314151760441	1	90
A7402DZ-7/8	7314153003034	1	90
A7402DZ-9/16	7314151760793	1	90
A7402SM-10	7314150541225	1	90
A7402SM-11	7314150541232	1	90
A7402SM-12	7314150542345	10	90
A7402SM-13	7314150542369	10	90
A7402SM-14	7314150542383	10	90
A7402SM-15	7314150542406	10	90
A7402SM-16	7314150542420	10	90
A7402SM-17	7314150542444	10	90
A7402SM-18	7314150542468	10	90
A7402SM-19	7314150542482	10	90
A7402SM-20	7314150542505	10	90
A7402SM-22	7314150542529	10	90
A7402SM-6	7314150542260	10	90
A7402SM-7	7314150542284	10	90
A7402SM-8	7314150542307	10	90
A7402SM-9	7314150542321	10	90
A7410DM-10	7314150543588	1	89
A7410DM-11	7314150543601	1	89
A7410DM-12	7314150543625	1	89
A7410DM-13	7314150543564	1	89
A7410DM-14	7314150543618	1	89
A7410DM-15	7314150543632	1	89
A7410DM-16	7314150543595	1	89
A7410DM-17	7314150543571	1	89
A7410DM-18	7314150543649	1	89
A7410DM-19	7314150543557	1	89
A7410DZ-1/2	7314153006301	1	89
A7410DZ-11/16	7314153006332	1	89
A7410DZ-3/4	7314153006349	1	89
A7410DZ-3/8	7314153006288	1	89
A7410DZ-5/16	7314153006271	1	89
A7410DZ-5/8	7314153006325	1	89
A7410DZ-7/16	7314153006295	1	89
A7410DZ-9/16	7314153006318	1	89
A7435DME*	7314153015006	1	72
A7535DZE*	7314153015013	1	73
ADJUST 3	7314150103515	1	41
ADJUST 3-90	7314150236336	1	40
ADJUST 9031/29	7314150302925	3	41
AP-234-F	7311518289027	2	614
AP-3M	7311518152062	1	613
AP-5M	7311518152079	1	613
APB260*	7314150389162	10	598
APB360*	7314150389186	10	598
AS-1200	7314150321520	3	533
AS-C33-JT-F	7314150341672	15	621
AS-C36-JT-M	7311518337490	15	621
AS-C39-JT-C	7314150341542	15	621
AS-C45-JT-C	7314150341559	15	621
ASP-1850	7311518337124	1	613
ASP-1850G	7311518337131	1	613
ASP-AS	7311518337377	6	613
ASP-AS-C33-JT-F	7314150341665	5	615
ASP-AS-C36-JT-M	7314150340590	5	616
ASP-AS-C39-JT-C	7314150341535	5	616
ASP-AS-C45-JT-C	7314150341566	2	616
ASP-AS-HOOK	7311518337582	4	614
ASP-ATP	7311518337384	6	613
ATP-110-210	7311518337575	1	613
ATP-200-350	7311518347062	1	613
ATP-200-500	7311518347055	1	613
ATP-230-410	7311518337599	2	614
AUTO	7314150438082	1	369



B141.007.075



B141.007.075	7314150278404	5	212
B141.008.075	7314150278411	5	212
B141.009.075	7314150278428	5	212
B141.010.075	7314150278435	5	212
B141.015.100	7314150278442	5	212
B141.020.100	7314150278459	5	212
B141.025.125	7314150278466	5	212
B141.027.125	7314150278473	5	212
B141.030.150	7314150278480	5	212
B141.040.150	7314150278497	5	212
B142.000.075	7314150278718	10	484
B142.001.080	7314150278725	10	484
B142.001.150	7314150343188	10	484
B142.002.100	7314150278732	10	484
B142.002.175	7314150343195	10	484
B142.003.150	7314150278749	10	484
B143.020.100	7314150278510	5	212
B143.025.100	7314150278503	10	212
B143.030.100	7314150278527	10	212
B143.040.100	7314150278534	10	212
B143.050.100	7314150278541	10	212
B143.060.125	7314150278558	10	212
B143.080.150	7314150278565	5	212
B144.001.100	7314150278787	5	212
B144.002.125	7314150278794	5	212
B144.003.150	7314150278800	5	212
B145.006.100	7314150278756	5	213
B146.006.100	7314150278763	5	213
B147.001.400	7314150285594	1	365
B147.003.400	7314150285600	1	365
B148.001.080	7314150314522	10	484
B148.002.100	7314150314539	10	484
B149.001.080	7314150314546	10	484
B149.002.100	7314150314553	10	484
B150.010.100	7314150343126	10	484
B150.015.125	7314150343133	10	484
B150.020.125	7314150343140	10	484
B150.025.150	7314150343157	10	484
B190.040.075	7314150277810	10	210
B190.040.100	7314150277827	10	210
B190.055.100	7314150277834	10	210
B190.055.125	7314150277841	10	210
B190.065.125	7314150277858	10	210
B190.065.150	7314150277865	10	210
B190.080.150	7314150277872	10	210
B190.080.175	7314150277889	10	210
B190.100.200	7314150277896	10	210
B190.120.250	7314150277902	10	210
B190.140.250	7314150277919	10	210
B191.025.075	7314150277926	10	210
B191.030.075	7314150277933	10	210
B191.030.100	7314150277940	10	210
B191.030.200	7314150277957	10	210
B191.035.100	7314150277964	10	210
B191.040.100	7314150277971	10	210
B191.040.125	7314150277988	10	210
B191.040.250	7314150277995	10	210
B191.055.125	7314150278008	10	210
B191.055.150	7314150278015	10	210
B191.055.300	7314150278022	10	210
B191.065.150	7314150278039	10	210
B191.065.300	7314150278046	10	210
B192.000.075	7314150278084	10	211
B192.000.200	7314150278091	10	211
B192.001.100	7314150278107	10	211
B192.001.250	7314150278114	10	211
B192.002.125	7314150278121	10	211
B192.002.150	7314150442720	10	211
B192.002.300	7314150278138	10	211
B192.003.150	7314150278145	10	211
B192.004.200	7314150278169	10	211
B193.000.075	7314150278190	10	211
B193.001.100	7314150278206	10	211
B193.002.125	7314150278213	10	211
B193.003.150	7314150278220	10	211
B193.004.200	7314150278237	10	211
B194.004.075	7314150278268	10	212
B194.005.075	7314150278275	10	212
B194.006.075	7314150278282	10	212
B194.007.075	7314150278299	10	212
B194.008.075	7314150278305	10	212
B194.009.075	7314150278312	10	212
B194.010.075	7314150278329	10	212
B194.015.100	7314150278336	10	212
B194.020.100	7314150278343	10	212
B194.025.125	7314150278350	10	212
B194.027.125	7314150278367	10	212
B194.030.150	7314150278374	10	212
B194.040.150	7314150278381	10	212
B194.045.150	7314150278398	5	212
B195.001.025	7314150278176	10	211
B195.002.025	7314150278183	10	211
B195.006.050	7314150289493	5	213
B195.040.025	7314150278053	10	210
B195.050.025	7314150278060	10	210
B195.060.025	7314150278077	10	210



B195.901.025	7314150278244	10	211
B195.902.025	7314150278251	10	211
B196.025.075	7314150278589	10	483
B196.030.100	7314150278572	10	483
B196.035.100	7314150278596	10	483
B196.040.100	7314150278602	10	483
B196.055.125	7314150278619	10	483
B196.065.150	7314150278626	10	483
B196.080.175	7314150278633	10	483
B196.100.200	7314150278640	10	483
B196.120.200	7314150278657	10	483
B197.000.075	7314150278664	10	484
B197.001.080	7314150278671	10	484
B197.001.150	7314150343164	10	484
B197.002.100	7314150278688	10	484
B197.002.175	7314150343171	10	484
B197.003.150	7314150278695	10	484
B197.004.200	7314150278701	10	484
B198.040.125	7314150278817	5	213
B198.045.125	7314150278824	5	213
B198.050.150	7314150278831	5	213
B198.055.150	7314150281268	5	213
B198.060.150	7314150281763	5	213
B198.060.150F	7314150281770	5	214
B198.070.150	7314150281787	5	213
B198.070.150F	7314150281794	5	214
B198.080.150	7314150281800	5	213
B198.080.150F	7314150281817	5	214
B198.090.150	7314150281824	5	213
B198.100.150	7314150281831	5	213
B198.110.150	7314150281848	5	213
B198.120.150	7314150281855	5	213
B198.130.150	7314150281862	5	213
B198.140.150	7314150281879	5	213
B199.055.125	7314150281886	5	484
B199.060.125	7314150281893	5	484
B199.070.125	7314150281909	5	484
B199.080.125	7314150281916	5	484
B199.090.125	7314150281923	5	484
B199.100.125	7314150281930	5	484
B199.110.125	7314150281947	5	484
B199.120.125	7314150287741	5	484
B199.130.125	7314150287772	5	484
B219.002	7314150289301	1	206
B219.004	7314150283248	1	206
B219.005	7314150283255	1	207
B219.006	7314150283293	1	208
B219.007	7314150283323	1	208
B219.008	7314150283347	1	209
B219.010	7314150283354	1	210
B219.012	7314150327768	1	206
B219.014	7314150533985	1	206
B219.015	7314150283262	1	207
B219.016	7314150283309	1	208
B219.017	7314150283330	1	208
B219.025	7314150283279	1	207
B219.026	7314150283316	1	208
B219.027	7314150399833	1	209
B219.035	7314150283286	1	207
B219.045	7314150533992	1	207
B219.110	7314150392667	1	209
B219.210	7314150438969	1	209
B220.002	7314150289295	1	484
B220.005	7314150283361	1	485
B220.007	7314150283385	1	485
B220.012*	7314150314614	1	484
B220.015	7314150283378	1	485
B220.017	7314150283392	1	485
B220.027	7314150283408	1	485
B400.002	8412814119441	1	594
B400.003	8412814119458	1	594
B400.004	8412814119465	1	594
B400.005	8412814119472	1	594
B400.006	8412814119489	1	595
B400.007	8412814119496	1	595
B400.008	8412814119502	1	595
B400.009	8412814119519	1	595
B400.010	8412814119526	1	595
B400.011	8412814119533	1	595
B400.012	8412814119540	1	595
B400.013	8412814119557	1	595
B400.014	8412814119564	1	595
B400.015	8412814119571	1	595
B400.016	8412814119588	1	595
B400.017	8412814119595	1	595
B400.018	8412814119601	1	595
B400.019	8412814119618	1	595
B400.020	8412814119625	1	595
B400.021	8412814119632	1	595
B400.022	8412814119649	1	595
B400.023	8412814119656	1	595
B400.024	8412814119663	1	595
B400.025	8412814119670	1	595
B400.026	8412814119687	1	595
B400.027	8412814119694	1	595
B400.028	8412814119700	1	595



B400.029	8412814119717	1	595
B400.030	8412814119724	1	595
B400.031	8412814119731	1	595
B400.032	8412814119748	1	595
B400.033	8412814119755	1	595
B400.034	8412814119762	1	595
B400.035	8412814119779	1	595
B400.036	8412814119786	1	595
B400.037	8412814119793	1	595
B400.038	8412814119809	1	595
B400.039	8412814119816	1	595
B400.040	8412814119823	1	595
B400.041	8412814119830	1	595
B400.042	8412814119847	1	595
B400.043	8412814119854	1	595
B400.044	8412814119861	1	595
B400.045	8412814119878	1	595
B400.046	8412814119885	1	595
B400.047	8412814119892	1	595
B400.048	8412814119908	1	595
B400.049	8412814119915	1	595
B400.050	8412814119922	1	595
B705.1/4.125	7314150281978	5	223
BAC007	7314150242337	1	309
BASIC	7314150437436	1	369
BB10	7314150240586	1	333
BBA1224-3200	7314150341955	1	332
BBAGM12-1200	7314150535675	1	332
BBAGM1224-2400	7314150535682	1	332
BBAGMBAT	7314150537709	1	332
BBAGMCAB	7314150537723	1	332
BBAGMCHG	7314150537747	1	332
BBBCAB-AUZ	7314150183944	1	336
BBBCAB-EU	7314150186648	1	336
BBBCAB-UK	7314150183937	1	336
BBC420	7314150243235	1	333
BBC620	7314150243242	1	333
BBCE12-10	7314150330263	2	333
BBCE12-15S	7314150406722	2	333
BBCE12-3	7314150330249	2	332
BBCE12-6	7314150330256	2	332
BBCE12-F100	7314150344710	1	333
BBCE24-10	7314150330287	2	333
BBCEC1	7314150335459	1	335
BBCEC2	7314150337460	1	335
BB CER1	7314150335466	1	335
BB CER2	7314150337484	1	335
BBJL1630	7314150244898	5	332
BBJL2535	7314150209453	1	332
BBJL3545	7314150209460	1	332
BBR100	7314150345922	1	319
BBR110	7314150170562	1	320
BBR1501	7314150439119	24	323
BBR201P6	7314150205752	8	322
BBR201P64014	7314150237852	1	322
BBR201P64016	7314150237753	1	322
BBR201P64018	7314150237760	1	322
BBR201P67814	7314150237777	1	322
BBR201P67816	7314150237784	1	322
BBR201P67818	7314150237791	1	322
BBR202P4	7314150205769	1	322
BBR202P410	7314150207688	1	322
BBR202P414	7314150207695	1	322
BBR202P419	7314150207701	1	322
BBR202P455	7314150231393	1	322
BBR203P9	7314150208081	1	322
BBR203P920	7314150231102	1	322
BBR203P925	7314150231119	1	322
BBR203P927	7314150231126	1	322
BBR203P930	7314150231133	1	322
BBR203P940	7314150231140	1	322
BBR203P945	7314150231157	1	322
BBR203P950	7314150231164	1	322
BBR203P955	7314150231171	1	322
BBR203P960	7314150231188	1	322
BBR204	7314150430635	6	323
BBR210P3	7314150206056	1	322
BBR300P50	7314150269624	4	322
BBR320	7314150169887	1	321
BBR350	7314150169900	1	320
BBR400	7314150345939	1	321
BBR405	7314150435807	20	321
BBR410	7314150345946	24	321
BBR420	7314150403394	50	321
BBR501011	7314150438143	50	320
BBR50121314*	7314150438150	50	320
BBR6131	7314150239443	1	323
BBR6135	7314150239450	1	322
BBRAS14	7314150416943	4	320
BBRAS14-01	7314150418060	1	320
BBRAS14-02	7314150418077	1	320
BBRAS14-03	7314150418084	1	320
BBRAS14-04	7314150418091	1	320
BBRAS14-05	7314150418107	1	320
BBRAS14-06	7314150418114	1	320
BBRAS14-07	7314150418121	1	320

* Until stocks last



BBRAS14-08	7314150418138	1	320
BBRAS14-09	7314150418145	1	320
BBRAS14-10	7314150418152	1	320
BBRAS14-11	7314150418169	1	320
BBRAS14-12	7314150418176	1	320
BBRAS14-13	7314150418183	1	320
BBRAS14-14	7314150418190	1	320
BBRBB12	7314150371297	1	320
BBRFKM1*	7314150384938	12	323
BBRPTG1	7314150412617	10	320
BBRS210P*	7314150206070	1	322
BBRS210P2	7314150206063	1	322
BBS075	7314150249824	12	339
BBS100	7314150169870	1	343
BBS10001	7314150207183	1	343
BBS10002	7314150207190	1	343
BBS10003	7314150207206	1	343
BBS10004	7314150207213	1	343
BBS10005	7314150207220	1	343
BBS100057	7314150186655	1	343
BBS10006	7314150207237	1	343
BBS10007	7314150207244	1	343
BBS10008	7314150207251	1	343
BBS10009	7314150207268	1	343
BBS10010	7314150207275	1	343
BBS101	7314150243525	1	340
BBS102	7314150243518	1	340
BBS103	7314150243488	1	339
BBS10450	7314150243501	1	340
BBS105	7314150250868	1	340
BBS106	7314150243495	1	339
BBS107	7314150250875	1	340
BBS108	7314150250882	1	340
BBS12SH	7314150243563	1	341
BBS150	7314150169849	1	339
BBS150R	7314150244959	1	340
BBS150S	7314150244973	1	340
BBS150T	7314150244966	1	340
BBS165	7314150205615	10	340
BBS165SP4	7314150205622	50	341
BBS170P13	7314150205608	1	340
BBS170P131	7314150231843	1	340
BBS170P132	7314150231850	1	340
BBS170P133	7314150231867	1	341
BBS170P134	7314150231874	1	341
BBS170P135	7314150231881	1	341
BBS170P136	7314150231898	1	341
BBS170P137	7314150231904	1	341
BBS170P138	7314150231911	1	341
BBS170P139	7314150231928	1	341
BBS200	7314150239498	1	343
BBS20P12	7314150169856	1	343
BBS210	7314150215362	1	343
BBS210U06	7314150217656	1	343
BBS210U08	7314150217663	1	343
BBS210UA06	7314150217670	1	343
BBS210UA08	7314150217687	1	343
BBS210V06	7314150217632	1	343
BBS210V08	7314150217649	1	343
BBS210W06	7314150218738	1	343
BBS210W08	7314150218745	1	343
BBS3BH1	7314150356843	1	339
BBS3BH1-VP	7314150355501	40	339
BBS3UH	7314150242351	1	339
BBS50	7314150169863	1	338
BBSDA	7314150247127	1	342
BBSDC	7314150247158	6	342
BBSDD	7314150247165	1	342
BBSDH	7314150247141	1	342
BBSDHR	7314150249299	1	342
BBSDT	7314150247134	6	342
BBSDW	7314150247110	6	342
BBSH1F	7314150247189	1	341
BBSH1M	7314150247196	1	341
BBSH2C	7314150247202	1	341
BBSH2CA	7314150247219	12	341
BBSH2CP	7314150247226	6	341
BBSH2F	7314150247172	6	341
BBSH3CF	7314150247240	6	341
BBSH3CF30	7314150247264	6	341
BBSH3FS	7314150247257	6	341
BBSH3MF	7314150247233	1	341
BBSHWH1	7314150328932	1	342
BBSS1	7314150247288	1	342
BBSS2	7314150247271	8	342
BBSS2L	7314150247295	1	342
BBT20	7314150166961	1	333
BBT60A	7314150504169	36	333
BBT80	7314150327805	6	333
BDACM1000	7314150500819	30	334
BE-3529	7314151847845	5	523
BE-6400M-4	7314153011145	5	200
BE-6400M-5	7314153011169	5	200
BE-6400M-5.5	7314153011176	5	200
BE-6400M-7	7314153011190	5	200
BE-6902	7314150242641	5	199





BE-6903	7314150242665	5	199
BE-6925	7314150242658	5	199
BE-6990-IP10	7314151846763	1	118
BE-6990-IP10-KL	7314151847531	10	119
BE-6990-IP15	7314151846770	1	118
BE-6990-IP15-KL	7314151847548	10	119
BE-6990-IP20-KL	7314151848668	10	119
BE-6990-IP6	7314151846725	1	118
BE-6990-IP6-KL	7314151847494	10	119
BE-6990-IP7	7314151846732	1	118
BE-6990-IP7-KL	7314151847500	10	119
BE-6990-IP8	7314151846749	1	118
BE-6990-IP8-KL	7314151847517	10	119
BE-6990-IP9	7314151846756	1	118
BE-6990-IP9-KL	7314151847524	10	119
BE-6990-IPSET	7314153019356	1	119
BE-6990TX-T10KL	7314151847760	10	119
BE-6990TX-T15KL	7314151847777	10	119
BE-6990TX-T20KL	7314151848682	10	119
BE-6990TX-T6-KL	7314151847722	10	119
BE-6990TX-T7-KL	7314151847739	10	119
BE-6990TX-T8-KL	7314151847746	10	119
BE-6990TX-T9-KL	7314151847753	10	119
BE-7515	7314150242528	5	198
BE-7520	7314150242535	5	198
BE-7525	7314150242542	5	198
BE-7527	7314150242559	5	198
BE-7530	7314150242566	5	198
BE-7540	7314150242573	5	198
BE-7606	7314151839017	5	201
BE-7607	7314151839024	5	201
BE-7608	7314151839031	5	201
BE-7675	7314150123896	1	234
BE-7715	7314150242580	5	198
BE-7720	7314150242597	5	198
BE-7725	7314150242603	5	198
BE-7727	7314150242610	5	198
BE-7730	7314150242627	5	198
BE-7740	7314150242634	5	198
BE-7803	7314151838867	5	200
BE-7804	7314151838881	5	200
BE-7805	7314151838904	5	200
BE-7806	7314151838928	5	200
BE-7806S	7314150242986	5	480
BE-7807	7314151838935	5	200
BE-7807S	7314150242993	5	480
BE-7808	7314151838942	5	200
BE-7808S	7314150243006	5	480
BE-7809	7314151838959	5	200
BE-7809S	7314150243013	5	480
BE-7810	7314151838966	5	200
BE-7810S	7314150243020	5	480
BE-7811	7314151838973	5	200
BE-7812	7314151838980	5	200
BE-7813	7314151838997	5	200
BE-7814	7314151839000	5	200
BE-7835	7314151838874	5	200
BE-7845	7314151838898	5	200
BE-7855	7314151838911	5	200
BE-7855S	7314150242979	5	480
BE-7907	7314153010964	5	198
BE-7908	7314153010971	5	198
BE-7909	7314153010988	5	198
BE-7910	7314151838799	5	198
BE-7915	7314151838805	5	198
BE-7920	7314151838812	5	198
BE-7925	7314151838829	5	198
BE-7927	7314151838836	5	198
BE-7930	7314151838843	5	198
BE-7940	7314151838850	5	198
BE-8002	7314150242825	5	196
BE-8010	7314150010615	5	196
BE-8010S	7314150033058	5	480
BE-8020	7314150010639	5	196
BE-8020I	7314150270316	5	516
BE-8020L	7314151838591	5	196
BE-8022	7314150242474	5	196
BE-8030	7314150010653	5	196
BE-8030I	7314150270330	5	516
BE-8040	7314150010677	5	196
BE-8040I	7314150270347	5	516
BE-8040S	7314150033089	5	480
BE-8040SL	7314150304578	10	482
BE-8050S	7314150033096	5	480
BE-8050SL	7314150304592	10	482
BE-8065S	7314150033119	5	480
BE-8080-1	7314153010995	5	199
BE-8080-10	7314153011060	5	199
BE-8080-2	7314153011008	5	199
BE-8080-3	7314153011015	5	199
BE-8080-4	7314153011022	5	199
BE-8080-5	7314153011039	5	199
BE-8080-6	7314153011046	5	199
BE-8080-8	7314153011053	5	199
BE-8135TB	7314150275052	10	205
BE-8145TB	7314150275076	10	205



BE-8150	7314150010707	5	196
BE-8150TB	7314150275113	10	205
BE-8155	7314150010721	5	196
BE-8155TB	7314150275090	10	205
BE-8158	7314153010858	5	196
BE-8159	7314153010865	5	196
BE-8160	7314150010745	5	196
BE-8210	7314151838584	5	196
BE-8220	7314150047741	5	196
BE-8220S	7314150048243	5	480
BE-8220SL	7314150304530	10	482
BE-8225	7314150242443	5	196
BE-8230	7314150047758	5	196
BE-8230S	7314150048250	5	480
BE-8230SL	7314150304554	10	482
BE-8235	7314150242450	5	196
BE-8240	7314150047765	5	196
BE-8241	7314150242467	5	196
BE-8241I	7314150270866	5	516
BE-8242	7314153010803	5	196
BE-8250	7314150047772	5	196
BE-8250L	7314151838607	5	196
BE-8251	7314150242461	5	196
BE-8252	7314153010810	5	196
BE-8252I	7314150270361	5	516
BE-8255	7314150047789	5	196
BE-8255S	7314150048281	5	480
BE-8255SL	7314150304615	5	482
BE-8256	7314153010827	5	196
BE-8256TB	7314150275137	10	205
BE-8257	7314153010834	5	196
BE-8258	7314153010841	5	196
BE-8258S	7314150242818	5	480
BE-8258TB	7314150275151	10	205
BE-8259S	7314150242832	5	480
BE-8260	7314150047796	5	196
BE-8262TB	7314150275526	10	205
BE-8330	7314151838614	5	196
BE-8340	7314151838621	5	196
BE-8350	7314151838638	5	196
BE-8355	7314151838652	5	197
BE-8360	7314151838676	5	197
BE-8450	7314151838645	5	197
BE-8455	7314151838669	5	197
BE-8510S	7314150126507	5	480
BE-8510SL	7314150304813	10	482
BE-8520S	7314150126514	5	480
BE-8520SL	7314150304837	10	482
BE-8571	7314150244652	1	203
BE-8572	7314150244669	1	203
BE-8573	7314150244676	1	204
BE-8574	7314150258666	1	204
BE-8575	7314150244638	1	201
BE-8576	7314150245741	1	204
BE-8577	7314151839048	5	201
BE-8600	7314150010769	5	197
BE-8600I	7314150270378	5	516
BE-8600S	7314150033126	5	480
BE-8601	7314151838706	5	197
BE-8602	7314151838713	5	197
BE-8605	7314150242498	5	197
BE-8608	7314150242504	5	197
BE-8610	7314150010776	5	197
BE-8610I	7314150270392	5	516
BE-8610L	7314151838683	5	197
BE-8610S	7314150033133	5	480
BE-8610SL	7314150304639	10	482
BE-8610TB	7314150275199	10	205
BE-8611	7311518292317	5	197
BE-8611S	7314150414703	5	480
BE-8612S	7314150242856	5	480
BE-8620	7314150010783	5	197
BE-8620I	7314150270408	5	516
BE-8620L	7314151838690	5	197
BE-8620S	7314150033140	5	480
BE-8620SL	7314150304653	10	482
BE-8620TB	7314150275212	10	205
BE-8621	7311518292324	5	197
BE-8621S	7314150242863	5	480
BE-8622	7314150242511	5	197
BE-8622S	7314150242870	5	480
BE-8623	7314153010872	5	197
BE-8623I	7314150270415	5	516
BE-8623TB	7314150275236	10	205
BE-8624	7314153010889	5	197
BE-8624TB	7314150275250	10	205
BE-8628	7314153010896	5	197
BE-8629	7314153010902	5	197
BE-8630	7314150010790	5	197
BE-8630S	7314150033157	5	480
BE-8640	7314150010806	5	197
BE-8640S	7314150033164	5	480
BE-8675	7314150123872	1	233
BE-8700-1/4	7314150242689	5	199
BE-8700-3/16	7314150242696	5	199
BE-8700-3/8	7314150242702	5	199



BE-8700-5/16	7314150242719	5	199
BE-8700-5/32	7314150242726	5	199
BE-8700-7/32	7314150242733	5	199
BE-8700-7/64	7314150275878	5	199
BE-8702	7314151838768	5	199
BE-8703	7314150027651	5	199
BE-8703S	7314151839130	5	480
BE-8704	7314150027668	5	199
BE-8704S	7314151839147	5	480
BE-8705	7314150027675	5	199
BE-8705S	7314151839154	5	480
BE-8706	7314150027682	5	199
BE-8706S	7314151839161	5	480
BE-8708	7314150027699	5	199
BE-8708S	7314151839178	5	480
BE-8710	7314150027705	5	199
BE-8710S	7314150126521	5	480
BE-8710SL	7314150304851	10	482
BE-8715	7314150242672	5	199
BE-8720S	7314150126538	5	480
BE-8720SL	7314150304875	10	482
BE-8725	7314151838775	5	199
BE-8725S	7314151839123	5	480
BE-8800	7314150042012	5	197
BE-8800I	7314150270422	5	516
BE-8800S	7314151839055	5	480
BE-8801	7314151838744	5	198
BE-8802	7314151838751	5	198
BE-8810	7314150010813	5	197
BE-8810I	7314150270439	5	516
BE-8810L	7314151838720	5	197
BE-8810S	7314150048298	5	480
BE-8810SL	7314150304677	10	482
BE-8810TB	7314150275274	10	205
BE-8811	7311518292331	5	197
BE-8811S	7314150414710	5	480
BE-8812S	7314150242894	5	480
BE-8820	7314150010820	5	197
BE-8820I	7314150270446	5	516
BE-8820L	7314151838737	5	197
BE-8820S	7314150048304	5	480
BE-8820SL	7314150304691	10	482
BE-8820TB	7314150275298	10	205
BE-8821	7311518292348	5	197
BE-8821S	7314150242900	5	480
BE-8822S	7314150242917	5	480
BE-8823	7314153010919	5	197
BE-8823I	7314150270453	5	516
BE-8823TB	7314150275311	10	205
BE-8824	7314153010926	5	197
BE-8824TB	7314150275335	10	205
BE-8828	7314153010933	5	197
BE-8829	7314153010940	5	197
BE-8830	7314150010837	5	197
BE-8830S	7314150048311	5	480
BE-8840	7314150010844	5	197
BE-8840S	7314151839062	5	480
BE-8865	7314150010851	5	196
BE-8870	7314150010875	5	196
BE-8880	7314150010899	5	196
BE-8890	7314150010905	5	196
BE-8904	7314153010957	5	198
BE-8905	7314153010049	5	198
BE-8905S	7314150242924	5	480
BE-8906	7314150027729	5	198
BE-8906S	7314150242931	5	480
BE-8907	7314150027736	5	198
BE-8907S	7314150242948	5	480
BE-8908	7314150027743	5	198
BE-8908S	7314150242955	5	480
BE-8909	7314150027750	5	198
BE-8909S	7314150242962	5	480
BE-8910	7314150027767	5	198
BE-8910I	7314150270460	5	516
BE-8910S	7314151839079	5	480
BE-8910SL	7314150304714	5	482
BE-8910TB	7314150275359	5	206
BE-8915	7314150027774	5	198
BE-8915I	7314150270477	5	516
BE-8915S	7314151839086	5	480
BE-8915SL	7314150304738	5	482
BE-8915TB	7314150275373	5	206
BE-8920	7314150027781	5	198
BE-8920I	7314150270484	5	516
BE-8920S	7314151839093	5	480
BE-8920SL	7314150304752	5	482
BE-8920TB	7314150275397	5	206
BE-8925	7314150027798	5	198
BE-8925I	7314150270491	5	516
BE-8925S	7314151839109	5	480
BE-8925SL	7314150304776	5	482
BE-8925TB	7314150275410	5	206
BE-8927	7314150027804	5	198
BE-8927TB	7314150275434	5	206
BE-8930	7314150027811	5	198
BE-8930S	7314151839116	5	480



BE-8930SL	7314150304790	5	482
BE-8930TB	7314150275458	5	206
BE-8940	7314150027828	5	198
BE-8940TB	7314150275472	5	206
BE-8945	7314151838782	5	198
BE-8975	7314150056576	6	233
BE-8975B	7314150188741	6	233
BE-8976B	7314150216369	6	234
BE-8980	7314153010681	5	200
BE-8985	7314153010698	5	200
BE-8986	7314150267026	5	200
BE-9001	7311518269005	5	199
BE-9002	7311518269012	5	199
BE-9003	7311518269029	5	199
BE-9100	7314150242757	5	199
BE-9101	7314150242764	5	199
BE-9102	7314150242771	5	199
BE-9103	7314150242788	5	199
BE-9104	7314150242795	5	199
BE-9105	7314150242801	5	199
BE-9575	7314150123841	1	232
BE-9578	7314150123803	1	229
BE-9585	7314150123858	1	233
BE-9586	7314150216000	1	230
BE-9588	7314150123810	1	230
BE-9675	7314150123889	1	233
BE-9676	7314150216017	1	231
BE-9678	7314150123827	1	231
BE-9688	7314150123834	1	231
BE-9765	7314150055128	3	231
BE-9770	7314150027712	3	231
BE-9770I	7314150276332	20	517
BE-9775	7314150056330	3	230
BE-9776	7314150056545	6	231
BE-9776B	7314150216352	6	231
BE-9777	7314150056552	6	230
BE-9777B	7314150188734	6	230
BE-9780	7314150033386	3	232
BE-9785	7314150056347	3	232
BE-9786I	7314150314485	1	517
BE-9787	7314150056569	6	230
BE-9871	7314150234707	1	195
BE-9871SL	7314150470792	1	483
BE-9872	7314150440412	1	195
BE-9872SL	7314150470785	1	483
BE-9875	7314150314447	1	195
BE-9876S	7314150315000	1	482
BE-9877	7314150320745	1	196
BE-9878	7314150186259	1	228
BE-9878SL	7314150321018	1	483
BE-9879	7314150383474	1	195
BE-9880	7314150238569	3	228
BE-9880SL	7314150337651	1	483
BE-9881	7314150043279	1	194
BE-9881I	7314150270507	1	516
BE-9881S	7314151839307	1	481
BE-9881SL	7314150304899	1	483
BE-9881TB	7314150275502	1	204
BE-9882	7314151839284	1	194
BE-9882I	7314150270514	1	516
BE-9882S	7314151839314	1	481
BE-9882SL	7314150304912	1	483
BE-9882TB	7314150275496	1	205
BE-9884	7314150243068	1	194
BE-9884S	7314150236602	1	481
BE-9885	7314150048465	1	194
BE-9885S	7314150126491	1	481
BE-9885TB	7314150275519	1	205
BE-9886	7314150048472	1	194
BE-9887S	7314150244744	1	481
BE-9888S	7314153006158	1	481
BE-9889S	7314150244751	1	481
BE-9890S	7314150237715	1	481
BE-9890SL	7314150315086	1	482
BE-9891SL	7314150321506	1	482
BE-9894SL	7314150321490	1	483
BE1100	7314150205929	8	305
BE110001	7314150230228	1	305
BE110014	7314150230204	1	304
BE110015	7314150230211	1	304
BE1100AC1	7314150230266	1	304
BE1100AC2	7314150333394	1	304
BE1200P6	7314150205516	1	302
BE1200P6AC1	7314150205523	1	302
BE1205	7314150205554	1	302
BE1210P11	7314150209101	1	303
BE1210P1101	7314150269822	1	302
BE1210P1102	7314150269839	1	302
BE1210P1103	7314150269846	1	302
BE1210P9AC1	7314150205547	1	303
BE1300	7314150205578	1	301
BE1300SH	7314150205585	10	301
BE1305P450*	7314150206032	1	301
BE1305P450WS01	7314150269228	1	301
BE1305P450WS02	7314150269235	1	301
BE1305P450WS03	7314150269242	1	301

* Until stocks last



BE1305P450WS04



BE1305P450WS04	7314150269327	1	301
BE1305P450WS05	7314150269334	1	301
BE1305P450WS06	7314150269341	1	301
BE1305P450WS07	7314150269358	1	301
BE1305P450WS08	7314150269365	1	301
BE1305P450WS09	7314150269372	1	301
BE1305P450WS10	7314150269310	1	301
BE1305P450WS11	7314150269389	1	301
BE1305P450WS12	7314150269396	1	301
BE1305P450WS13	7314150269402	1	301
BE1305P450WS14	7314150269419	1	301
BE1305P450WS15	7314150269426	1	301
BE1310P4*	7314150205707	1	300
BE1310P425	7314150233649	1	300
BE1310P427	7314150233656	1	300
BE1310P429	7314150233663	1	300
BE1310P430	7314150233670	1	300
BE1311P13	7314150235414	1	300
BE1312DNS*	7314150450596	12	301
BE1315P7	7314150205776	1	301
BE1315P71	7314150230273	1	301
BE1315P72	7314150230280	1	301
BE1315P73	7314150230297	1	301
BE1315P74	7314150230303	1	301
BE1315P75	7314150230310	1	301
BE1315P76	7314150230327	1	301
BE1315P77	7314150230334	1	301
BE1320S17	7314150415366	10	300
BE13ZL11	7314150239733	1	302
BE1FFWF	7314150403325	12	311
BE1FLD1	7314150250745	1	311
BE1FLD2	7314150250752	1	311
BE1FLD3	7314150250769	1	311
BE1FLDS	7314150250783	1	311
BE1FTW	7314150251209	1	311
BE1GP5	7314150170043	1	302
BE1GP5-T	7314150170050	10	303
BE1GP510	7314150207732	1	303
BE1GP512	7314150207749	1	303
BE1GP514	7314150207756	1	303
BE1GP58	7314150207718	1	303
BE1GP59	7314150207725	1	303
BE1P	7314150170067	1	303
BE1SP14L	7314150170074	1	303
BE1SP16L	7314150492756	10	303
BE1SP1F*	7314150435777	12	303
BE1T14	7314150167630	1	304
BE1T16	7314150167647	1	304
BE1T21	7314150167654	1	304
BE1TH-10	7314150343980	5	312
BE1TH-2	7314150343874	10	312
BE1TH-2.5	7314150343881	10	312
BE1TH-3	7314150343898	10	312
BE1TH-3.5*	7314150343904	10	312
BE1TH-4	7314150343911	10	312
BE1TH-4.5*	7314150343928	10	312
BE1TH-5	7314150343935	10	312
BE1TH-6	7314150343942	10	312
BE1TH-7*	7314150343959	10	312
BE1TH-8	7314150343966	10	312
BE1TH-9*	7314150343973	10	312
BE1TH-S5	7314150457502	1	312
BE1TH-S6	7314150344017	30	312
BE1TS-10	7314150344062	10	312
BE1TS-11*	7314150344079	10	312
BE1TS-12	7314150344086	10	312
BE1TS-13	7314150344093	10	312
BE1TS-14	7314150344109	10	312
BE1TS-15*	7314150344116	10	312
BE1TS-16*	7314150344123	10	312
BE1TS-17	7314150344130	10	312
BE1TS-18*	7314150344147	10	312
BE1TS-19*	7314150344154	10	312
BE1TS-20*	7314150344161	8	312
BE1TS-21*	7314150344178	8	312
BE1TS-22*	7314150344185	8	312
BE1TS-24*	7314150344192	8	312
BE1TS-6	7314150344024	10	312
BE1TS-7	7314150344031	10	312
BE1TS-8	7314150344048	10	312
BE1TS-9*	7314150344055	10	312
BE1TS-S7	7314150344208	1	312
BE200CAB250SH10*	7314150165452	1	354
BE200CAB250SH25	7314150165469	1	354
BE200CAB250SH3*	7314150165445	1	354
BE200CAB40F1*	7314150165391	1	354
BE200CAB55F1*	7314150165407	1	354
BE200CAB55F3*	7314150165414	1	354
BE200CAB58SR1	7314150165421	1	354
BE200CAB58SR3	7314150165438	1	354
BE200CAB80SR1	7314150165384	1	354
BE200CAB80SR3	7314150165476	1	354
BE200MAG55	7314150165513	1	354
BE200MIR4035	7314150245161	1	354
BE200MIR4055	7314150245185	1	354
BE200MIR5535	7314150165483	1	354



BE200MIR5545	7314150165490	1	354
BE200MIR5555	7314150165506	1	354
BE200MIR8035	7314150165520	1	354
BE200MIR8045	7314150165537	1	354
BE200MIR8055	7314150165544	1	354
BE220	7314150170005	1	354
BE230	7314150182633	1	299
BE239	7314150243143	1	299
BE240	7314150239917	1	299
BE240-CAT	7314150289417	1	299
BE250	7314150169924	1	309
BE251200	7314150249343	1	328
BE2512005	7314150249350	1	328
BE2512008	7314150249367	1	329
BE251A	7314150540136	12	310
BE253	7314150250806	1	310
BE2541	7314150251797	1	310
BE2542	7314150251803	1	310
BE254A	7314150446070	1	310
BE254A-01	7314150453405	1	310
BE256-155	7314150205875	1	311
BE256-178	7314150205882	1	311
BE256-250	7314150205899	1	311
BE256M	7314150205851	1	310
BE256P3	7314150205868	1	311
BE257	7314150205844	8	300
BE25710	7314150230549	1	300
BE25718	7314150230532	1	300
BE2572	7314150230556	1	300
BE2576	7314150230525	1	300
BE258	7314150251780	1	310
BE301	7314150430871	2	330
BE301CM	7314150430888	50	330
BE301CM-01	7314150430956	20	330
BE301CM-02	7314150430963	20	330
BE310	7314150205943	8	330
BE400P24	7314150205806	1	305
BE400P2401	7314150230600	1	306
BE400P2402	7314150230617	1	306
BE400P2403	7314150230624	1	306
BE400P2404	7314150230631	1	306
BE400P2405	7314150230648	1	306
BE400P2406	7314150230655	1	307
BE400P2407	7314150230662	1	307
BE400P2408	7314150230679	1	307
BE400P2409	7314150230686	1	307
BE400P241	7314150230663	1	306
BE400P2410	7314150230693	1	307
BE400P2411	7314150230709	1	307
BE400P2412	7314150230716	1	307
BE400P2413	7314150230723	1	307
BE400P2414	7314150230730	1	307
BE400P2415	7314150230747	1	308
BE400P2416	7314150230754	1	308
BE400P2417	7314150230761	1	308
BE400P2418	7314150230778	1	308
BE400P2419	7314150230785	1	308
BE400P242	7314150230570	1	306
BE400P2420	7314150237647	1	308
BE400P243	7314150230587	1	306
BE400P244	7314150230594	1	306
BE401	7314150240593	1	305
BE410	7314150205813	4	308
BE4101	7314150230792	1	308
BE5008*	7314150239344	1	302
BE5008-10*	7314150239269	1	302
BE5008-15*	7314150239276	1	302
BE5008-20*	7314150239283	1	302
BE5008-25*	7314150239290	1	302
BE5008-27*	7314150239306	1	302
BE5008-30*	7314150239313	1	302
BE5008-40*	7314150239320	1	302
BE5008-45*	7314150239337	1	302
BE500P24	7314150169955	5	299
BE500P2401	7314150209569	1	299
BE500P2402	7314150209682	1	299
BE500P2403	7314150209736	1	299
BE500P2404	7314150209729	1	299
BE500P2405	7314150209613	1	299
BE500P2406	7314150209804	1	299
BE500P2407	7314150209781	1	299
BE500P2408	7314150209743	1	299
BE500P2409	7314150209750	1	299
BE500P2410	7314150209637	1	299
BE500P2411	7314150209644	1	299
BE500P2412	7314150209699	1	299
BE500P2413	7314150209705	1	299
BE500P2414	7314150209798	1	299
BE500P2415	7314150209675	1	299
BE500P2416	7314150209620	1	299
BE500P2417	7314150209583	1	299
BE500P2418	7314150209576	1	299
BE500P2419	7314150209767	1	299
BE500P2420	7314150209590	1	299
BE500P2421	7314150209606	1	299
BE500P2422	7314150209774	1	299



BE500P2423	7314150209668	1	299
BE500P2424	7314150209712	1	299
BE501101	7314150274499	1	292
BE501102	7314150274505	1	292
BE501203	7314150274529	1	292
BE501204	7314150274536	1	292
BE502101	7314150274543	1	292
BE502102	7314150274550	1	293
BE502103*	7314150274567	1	293
BE502104*	7314150384952	8	292
BE502106*	7314150403370	10	292
BE502204	7314150274574	1	293
BE5032	7314150189885	1	308
BE503201	7314150274581	1	293
BE5032H10EL	7314150220953	1	313
BE5032H14	7314150220960	1	313
BE5032M14	7314150220977	1	313
BE5032SQ10	7314150220991	1	309
BE5032SQ8	7314150220984	1	309
BE5032T55EL	7314150220946	1	314
BE504102	7314150274666	1	293
BE504201	7314150274369	1	293
BE5049	7314150169931	5	312
BE504901	7314150184576	1	312
BE504902	7314150184583	1	313
BE5049H10	7314150184705	1	313
BE5049H10L	7314150184712	1	313
BE5049H12	7314150184729	1	313
BE5049H12L	7314150184736	1	313
BE5049H4	7314150184590	1	313
BE5049H4L	7314150184606	1	313
BE5049H5	7314150184613	1	313
BE5049H5L	7314150184620	1	313
BE5049H6	7314150184637	1	313
BE5049H6L	7314150184651	1	313
BE5049H7	7314150184668	1	313
BE5049H7L	7314150184675	1	313
BE5049H8	7314150184682	1	313
BE5049H8L	7314150184699	1	313
BE5049M10	7314150184804	1	313
BE5049M10L	7314150184811	1	314
BE5049M12	7314150184828	1	313
BE5049M12L	7314150184835	1	314
BE5049M5	7314150184743	1	313
BE5049M5L	7314150184750	1	314
BE5049M6	7314150184767	1	313
BE5049M6L	7314150184774	1	314
BE5049M8	7314150184781	1	313
BE5049M8L	7314150184798	1	314
BE5049T	7314150325474	1	314
BE5049T20	7314150216048	1	313
BE5049T20H	7314150184842	1	313
BE5049T20HL	7314150184859	1	314
BE5049T20L	7314150221011	1	314
BE5049T25	7314150216055	1	313
BE5049T25H	7314150184866	1	313
BE5049T25HL	7314150184873	1	314
BE5049T25L	7314150221028	1	314
BE5049T27	7314150216062	1	313
BE5049T27H	7314150184880	1	313
BE5049T27HL	7314150184897	1	314
BE5049T27L	7314150221035	1	314
BE5049T30	7314150216079	1	313
BE5049T30H	7314150184903	1	313
BE5049T30HL	7314150184910	1	314
BE5049T30HXL	7314150184927	1	314
BE5049T30L	7314150221042	1	314
BE5049T40	7314150216086	1	313
BE5049T40H	7314150184934	1	313
BE5049T40HL	7314150184941	1	314
BE5049T40HXL	7314150185092	1	314
BE5049T40L	7314150221059	1	314
BE5049T45	7314150216093	1	313
BE5049T45H	7314150184958	1	313
BE5049T45HL	7314150184965	1	314
BE5049T45HXL	7314150184972	1	314
BE5049T45L	7314150216123	1	314
BE5049T50	7314150216109	1	313
BE5049T50H	7314150184989	1	313
BE5049T50HL	7314150184996	1	314
BE5049T50L	7314150221066	1	314
BE5049T55	7314150216116	1	313
BE5049T55H	7314150185009	1	313
BE5049T55HL	7314150185016	1	314
BE5049T55L	7314150221073	1	314
BE5049T60	7314150221004	1	313
BE5049T60H	7314150185023	1	313
BE5049T60HL	7314150185030	1	314
BE5049T70HL	7314150185047	1	314
BE5049T80HL	7314150186532	1	314
BE505101	7314150274598	1	294
BE505102	7314150274604	1	294
BE505203	7314150274611	1	294
BE505204	7314150274628	1	294
BE506101	7314150274376	1	294
BE506102	7314150274635	1	294

* Until stocks last



BE506103	7314150274642	1	295
BE506204	7314150274659	1	295
BE507101	7314150274673	1	295
BE507102	7314150274680	1	295
BE507203	7314150274697	1	295
BE508101	7314150274765	1	296
BE508202	7314150274772	1	296
BE508203	7314150274703	1	296
BE508204	7314150274710	1	296
BE509101	7314150274727	1	296
BE509102	7314150274734	1	296
BE509103	7314150274383	1	297
BE509104	7314150274741	1	297
BE509205	7314150274390	1	297
BE509206	7314150274406	1	297
BE509207	7314150274758	1	297
BE5100	7314150205646	1	299
BE5101	7314150205721	1	313
BE510101	7314150274420	1	297
BE510102	7314150274437	1	297
BE510125	7314150230877	1	309
BE510127	7314150230884	1	309
BE510130	7314150230891	1	309
BE510140	7314150230907	1	309
BE510145	7314150230914	1	309
BE510150	7314150230921	1	309
BE510155	7314150230938	1	309
BE510160	7314150230945	1	309
BE5102	7314150205738	1	304
BE510203	7314150274789	1	298
BE510210	7314150231003	1	304
BE510211	7314150231010	1	304
BE510212	7314150231027	1	304
BE510213	7314150231034	1	304
BE51025	7314150230952	1	304
BE51026	7314150230969	1	304
BE51027	7314150230976	1	304
BE51028	7314150230983	1	304
BE51029	7314150230990	1	304
BE5103	7314150205745	1	304
BE510304	7314150274444	1	298
BE510310	7314150231072	1	304
BE510312	7314150231089	1	304
BE510314	7314150231096	1	304
BE51035	7314150231041	1	304
BE51036	7314150231058	1	304
BE51038	7314150231065	1	304
BE51101	7314150274451	1	298
BE51102	7314150274468	1	298
BE511203	7314150274796	1	298
BE512201	7314150274475	1	300
BE513201	7314150274802	1	298
BE5150P27	7314150205790	1	309
BE5150P271	7314150230808	1	309
BE5150P272	7314150230815	1	309
BE5150P273	7314150230822	1	309
BE5200	7314150205905	1	313
BE52001	7314150230433	1	313
BE52002	7314150230440	1	313
BE52003	7314150230457	1	313
BE523106	7314150178391	1	298
BE530001	7314150205912	1	313
BE5350*	7314150206049	5	301
BE5350C1	7314150230389	1	301
BE5350C2	7314150230396	1	301
BE5350C3	7314150230402	1	301
BE5350C4	7314150230419	1	301
BE5350C5	7314150230426	1	301
BE5400P	7314150245086	1	299
BE5401D	7314150245062	1	299
BE5500	7314150403233	25	311
BE550010	7314150432936	1	311
BE550011	7314150432943	1	311
BE550012	7314150432950	1	311
BE550014	7314150432967	1	311
BE550017	7314150432974	1	311
BE550019	7314150432981	1	311
BE61110	7314150167449	1	315
BE61110-1	7314150167463	10	315
BE61155	7314150167456	12	315
BE61155-1	7314150167470	1	315
BE62110	7314150403332	10	315
BE62155	7314150403349	10	315
BE6217	7314150169702	1	317
BE621701	7314150232642	1	317
BE621702	7314150232659	1	317
BE621703	7314150232666	1	317
BE621704	7314150232673	1	317
BE621705	7314150232680	1	317
BE621706	7314150232697	1	317
BE621707	7314150232703	1	317
BE621708	7314150232710	1	317
BE621709	7314150232727	1	317
BE621710	7314150232734	1	317
BE621711	7314150232741	1	317
BE621712	7314150232758	1	317





BE621713	7314150232765	1	317
BE621714	7314150232772	1	317
BE621715	7314150232789	1	317
BE621716	7314150232796	1	317
BE621717	7314150232802	1	317
BE630	7314150169580	3	316
BE63010015F	7314150232598	25	316
BE63010615F	7314150232604	1	316
BE63010815F	7314150232611	1	316
BE63010818F	7314150232628	1	316
BE630246F	7314150169597	50	316
BE6302712F	7314150412846	5	316
BE630276F	7314150169603	50	316
BE630326F	7314150169610	50	316
BE630366F	7314150169627	100	316
BE630386F	7314150169634	50	316
BE63064514F1	7314150340095	1	316
BE63064514F2	7314150340101	1	317
BE6306514F	7314150232123	12	316
BE630656714F	7314150232130	12	316
BE63066514F	7314150169641	25	316
BE630666F	7314150232116	1	316
BE6306814F	7314150232154	1	316
BE6307314F	7314150232161	1	316
BE6307414F	7314150370108	10	317
BE6307415F	7314150232178	1	316
BE630747615F	7314150232307	12	316
BE630757715F	7314150232321	1	316
BE6307612F	7314150232345	12	316
BE6307614F	7314150232369	12	316
BE6307630F	7314150232437	1	316
BE630768F	7314150232468	1	316
BE6307815F	7314150232475	12	316
BE6308015F	7314150232482	1	316
BE630808215F	7314150232499	1	316
BE6308414F	7314150543205	12	316
BE6308616F	7314150232505	1	316
BE6308618F	7314150232512	1	316
BE6309015F	7314150232529	12	316
BE6309210F	7314150232536	1	316
BE6309315F	7314150232543	1	316
BE6309336F	7314150232550	1	316
BE6309345F	7314150232567	1	316
BE6309515F	7314150232574	1	316
BE6309618F	7314150232581	1	316
BE64350	7314150169672	1	315
BE64350CH	7314150169696	1	315
BE64520	7314150169665	1	315
BE64520CH	7314150169689	1	315
BE65F65120	7314150169658	12	315
BE65R106160	7314150170036	1	316
BE65R65120	7314150170012	1	316
BE65R80120	7314150170029	1	316
BE66152A	7314150492534	6	315
BE6701VAG	7314150333875	1	317
BE68	7314150237876	1	317
BE6810	7314150237869	1	317
BE6810Z	7314150430765	12	317
BE6FCP	7314150438907	30	311
BE6OF108	7314150434572	50	315
BE6OFW	7314150435784	5	315
BE700*	7314150206087	1	308
BE700BP2	7314150206100	1	308
BE700SP15	7314150206094	1	308
BE74-55100	7314150169733	1	305
BE74-57125	7314150169511	1	305
BE74-57125L	7314150169535	1	305
BE74-80120	7314150169740	1	305
BE74-90175	7314150169528	1	305
BE76101	7314150240005	1	301
BE762	7314150384983	12	301
BE800P12	7314150205677	1	309
BELMS12OBDL	7314150340323	8	331
BELP1224	7314150177882	1	335
BELS12	7314150170579	1	335
BELT1213A	7314150493104	1	334
BELT127*	7314150177899	1	334
BELT2415A	7314150493098	20	334
BELT247N	7314150170586	1	334
BELT247S	7314150170593	1	334
BELTKEY*	7314150177875	1	334
BELTRP16	7314150169917	1	335
BELTRP1601	7314150231935	1	335
BELTRP1602	7314150231942	1	335
BELTRP1603	7314150231959	1	335
BELTRP1604	7314150231966	1	335
BELTRP1605	7314150231973	1	335
BELTRP1606	7314150231980	1	335
BELTRP1607	7314150231997	1	335
BELTRP1608	7314150232000	1	335
BELTRP1609	7314150232017	1	335
BELTRP1610	7314150232024	1	335
BELTRP1611	7314150232031	1	335
BELTRP1612	7314150232048	1	335
BELTRP1613	7314150232062	1	335
BELTRP1614	7314150232079	1	335



BELTRP1615	7314150232086	1	335
BELTRP1616	7314150232093	1	335
BFRL11	73141503066534	1	352
BGIS125	7314150416431	20	335
BH110000A-02	7314150273669	1	346
BH110000A-04	7314150273683	1	346
BH110000A-EXT*	7314150291946	1	346
BH110000B	7314150516414	1	346
BH11500	7314150178797	1	345
BH11500-01	7314150182220	1	350
BH11500-02	7314150182237	1	346
BH11500-04	7314150182275	1	346
BH12000	7314150178803	1	345
BH13000	7314150178810	1	345
BH13000-02	7314150182244	1	346
BH13000L	7314150301980	1	346
BH13000L-01	7314150301997	1	350
BH13000QA	7314150403295	1	345
BH15000A-01	7314150273515	1	350
BH15000A-02	7314150273522	1	346
BH15000A-04	7314150273546	1	346
BH15000B	7314150516407	1	346
BH1A1500-04	7314150265299	1	350
BH1A1500A	7314150460946	1	345
BH1A2500-03	7314150226856	1	346
BH1A2500-04	7314150226863	1	350
BH1A2500A	7314150460953	1	345
BH1CB1000	7314150243204	1	346
BH1CD680	7314150330379	1	349
BH1CD680ST	7314150330386	1	349
BH1EU3000	7314150245000	1	345
BH1EU3000-01	7314150250004	1	346
BH1EU3000-03	7314150249893	1	346
BH1EU3000-08	7314150249947	1	350
BH1S45	7314150292295	1	346
BH1S45-01	7314150311194	1	350
BH1S45-03	7314150311217	1	346
BH230	7314150264070	1	347
BH23015	7314150178759	1	347
BH23015C	7314150178742	1	347
BH2402010	7314150178766	1	347
BH2604020	7314150178773	1	347
BH28050	7314150472222	1	348
BH2AC60V110*	7314150178933	1	348
BH33000	7314150178674	1	348
BH36000	7314150178681	1	348
BH3A10000	7314150234660	1	348
BH3A3000	7314150234646	1	348
BH3A5000	7314150234653	1	348
BH3AL2500*	7314150302420	1	348
BH3HD12000	7314150170500	1	348
BH3HD16000	7314150170524	1	348
BH3HD20000A	7314150337668	1	349
BH3HD8000	7314150170494	2	348
BH3SQ15000	7314150234684	2	348
BH3SQ7000	7314150234677	2	348
BH4B12	7314150557806	2	344
BH4B2	7314150557820	10	344
BH4B20	7314150557844	2	344
BH4B30	7314150557783	1	344
BH4B5	7314150557868	6	344
BH4B8	7314150557882	4	344
BH4G12	7314150557905	4	344
BH4G2	7314150557929	4	344
BH4G20	7314150557943	2	344
BH4G4	7314150557967	6	344
BH4G50	7314150557981	1	344
BH4G6	7314150558001	4	344
BH4G8	7314150558025	4	344
BH4HP50	7314150477081	1	345
BH5DP1000QA	7314150270224	1	349
BH5SP500QA	7314150270217	1	349
BH5US1000	7314150243174	1	349
BH6AC1-680A	7314150433544	1	350
BH6FC1000	7314150178650	1	350
BH6FC2000	7314150234639	1	350
BH6PC600	7314150234622	1	349
BH7100A	7314150345908	1	336
BH7100SG	7314150299782	1	337
BH715	7314150237555	1	336
BH715-13	7314150239191	1	336
BH720	7314150235650	1	336
BH720-22	7314150236961	1	336
BH720SG	7314150238477	1	336
BH730	7314150235667	1	336
BH730SG	7314150238484	1	336
BH750	7314150235674	1	336
BH750SG	7314150238491	1	336
BH7PS30	7314150474882	2	336
BH8AC1-500	7314150170463	1	309
BH8AC2-500	7314150412532	1	309
BH8AC3-1500A	7314150516391	1	349
BH8AC3-600	7314150351893	1	349
BH8BC1	7314150242276	1	344
BH8BC2	7314150242283	1	344
BH8BC3	7314150242290	10	344



BH8BC4	7314150242306	6	344
BH8BC5	7314150242313	6	344
BH8PR10000	7314150178957	1	344
BH8PR4000	7314150178940	1	344
BH9BJ22SLH	7314150246946	1	347
BH9BJ22SSH	7314150247462	1	346
BH9BJ23SLH	7314150246953	1	347
BH9BJ23SSH	7314150246960	1	347
BH9BJ260	7314150247509	1	347
BH9BJ280	7314150247516	1	347
BHVG15-250	7314150403745	1	350
BHVIS06100	7314150167753	1	327
BHVIS06105	7314150167760	1	327
BHVIS0670	7314150167692	1	327
BHVIS0677	7314150167708	1	327
BHVIS0680	7314150167715	1	327
BHVIS0685	7314150167722	1	327
BHVIS0690	7314150167739	1	327
BHVIS0695	7314150167746	1	327
BHVIS08100	7314150165711	1	327
BHVIS08115	7314150165728	1	327
BHVIS0895	7314150165704	1	327
BHVIS109BPW12	7314150165759	1	327
BHVIS111BPW12	7314150165735	1	327
BHVIS120BPW16	7314150165742	1	327
BHVIS1265	7314150167685	1	327
BHVIS80BPW12	7314150165766	1	327
BHVIS95BPW9	7314150243334	1	327
BKE850901N	7314150449705	10	234
BLBT100	7314150179015	1	338
BLBT100AC1	7314150179022	1	338
BLCR230FR	7314150247356	1	352
BLCR230SC	7314150247349	1	352
BLCR400E	7314150247363	1	352
BLCRSC1	7314150247530	1	352
BLCRSC2	7314150247547	1	352
BLE300	7314150227648	1	337
BLE301	7314150227662	1	338
BLE302	7314150227679	1	338
BLE304	7314150249572	1	338
BLE305	7314150339341	1	337
BLEMAT1*	7314150477678	1	337
BLEMAT1BT*	7314150477685	1	337
BLT550	7314150243556	10	300
BLTFC1	7314150246434	20	352
BLTS10	7314150246427	20	352
BLTS7P	7314150246410	58	352
BMD150	7314150242238	1	337
BMMTRMS1	7314150274024	1	334
BMR240	7314150242245	1	337
BMVAT1000	7314150488360	50	334
BOD101	7314150205967	1	317
BOD1016	7314150169979	1	319
BOD101NWS	7314150269099	1	317
BOD101T	7314150269150	1	319
BOD102	7314150205974	1	317
BOD102NWS	7314150269105	1	317
BOD102T	7314150269167	1	319
BOD103	7314150205981	1	317
BOD103NWS	7314150269112	1	317
BOD103T	7314150269174	1	319
BOD104	7314150205998	1	317
BOD104NWS	7314150269129	1	317
BOD104T	7314150269181	1	319
BOD105	7314150206001	1	317
BOD105NWS	7314150269136	1	317
BOD105T	7314150269198	1	319
BOD106	7314150206018	1	317
BOD106NWS	7314150269143	1	317
BOD106T	7314150269204	1	319
BOD10P64	7314150205950	8	317
BOD2008	7314150169986	1	319
BOD2FS	7314150351879	20	319
BOD301200	7314150169993	1	318
BOD4200	7314150169436	1	318
BOD4500	7314150169443	1	318
BOD5400	7314150169450	1	319
BOD5450	7314150169474	1	319
BOD5HD400	7314150169467	1	319
BOD60	7314150169481	1	319
BOD6080P12	7314150235407	1	318
BOD6080P12-11	7314150235544	1	318
BOD70	7314150169498	1	319
BOD8901	7314150169016	1	318
BOD8901AC1	7314150178490	1	318
BOD8902	7314150169023	1	318
BOD8903A	7314150265374	1	318
BOM10X	7314150540549	10	355
BP-40	7314150453085	1	561
BP-40-95	7314150487097	12	561
BP110	7314150135011	1	282
BP111E*	7314150235872	12	282
BP115	7314150134991	1	281
BP117*	7314150184309	1	281
BP117EH	7314150184316	1	282
BP118*	7314150235834	1	281

* Until stocks last



BP125A	7314150427291	6	288
BP127	7314150137565	1	283
BP12718	8414909179002	1	283
BP127P*	7314150427277	1	283
BP204*	7314150184286	1	284
BP20425180*	7314150185924	1	284
BP204K*	7314150184293	1	284
BP204PAD*	7314150185917	1	284
BP212	7314150134601	1	284
BP215A*	7314150341849	10	288
BP218	7314150170272	1	288
BP219	7314150235889	1	289
BP219L	7314150235896	1	289
BP219V*	7314150307197	1	289
BP219XL	7314150427192	10	289
BP222	7314150137572	1	285
BP233	7314150134748	1	286
BP254	7314150137633	1	289
BP255	7314150137640	1	289
BP255T*	7314150427307	1	290
BP255T-1	7314150427314	1	290
BP277K*	7314150427284	8	288
BP421M*	7314150134625	1	281
BP423M*	7314150134649	1	281
BP424M*	7314150134656	1	281
BP430M*	7314150134663	1	282
BP431M*	7314150134670	1	282
BP432M*	7314150134687	1	282
BP433M*	7314150134694	1	282
BP434M*	7314150135837	1	282
BP500*	7314150137992	1	289
BP601	7314150134526	1	284
BP60102	7314150426669	1	284
BP610	7314150134595	1	285
BP700	7314150134458	20	280
BP704	7314150427130	1	278
BP721*	7314150427185	1	280
BP799	7314150134502	1	288
BP79912	7314150134717	1	288
BP809*	7314150235841	1	285
BP80950	7314150275564	1	285
BP810*	7314150235858	1	285
BP811*	7314150235865	1	287
BP814*	7314150184262	10	278
BP814A	7314150304349	10	278
BP815	7314150134311	1	278
BP815K1*	7314150181957	1	278
BP817	7314150134106	1	279
BP820*	7314150134465	1	280
BP821	7314150134472	1	280
BP822	7314150134984	1	281
BP822E	7314150184279	10	281
BP823	7314150135004	1	282
BP825	7314150134496	1	285
BP826*	7314150137459	1	286
BP827*	7314150137442	1	286
BP828	7314150427260	1	286
BP830CISB*	7314150439799	1	283
BP830ESB*	7314150439751	1	283
BP830EWB*	7314150439768	1	283
BP830K*	7314150427208	4	283
BP830MISB*	7314150439782	1	283
BP830SBA*	7314150439805	1	283
BP830SSB*	7314150439775	1	284
BP830SW*	7314150439744	1	284
BP901	7314150336012	1	280
BP901L	7314150336029	1	280
BP905L	7314150336234	2	280
BP905P	7314150336210	2	280
BP909NE*	7314150187980	1	288
BP909NF*	7314150187973	1	287
BP909TE*	7314150187942	1	287
BP909TF*	7314150187911	1	287
BP909TH*	7314150187959	1	287
BP909TSP*	7314150187966	1	287
BP909TTP*	7314150187935	1	287
BP910	7314150427246	5	287
BP91BL	7314150192779	1	281
BP91BS	7314150192786	1	281
BPA823*	7314150427161	1	286
BPBG3515*	7314150134823	1	286
BPBG3525A*	7314150134830	1	286
BPBG3525B*	7314150134847	1	286
BPBG5725*	7314150134861	1	287
BPBG9057*	7314150134878	1	287
BPBL00900*	7314150358335	5	339
BPBL30900	7314150360451	5	339
BPBL70600*	7314150360468	5	339
BPBL90600*	7314150358366	5	339
BPBLS4	7314150360475	2	339
BPBSC156*	7314150134816	1	286
BPBU18*	7314150134755	1	286
BPBU24*	7314150134762	1	286
BPBU36*	7314150134779	1	286
BPBU60*	7314150134786	1	286
BPBU90*	7314150134793	1	286



GPC813



BPC813	7314150296408	10	278
BPC813K1*	7314150331253	1	278
BPC814	7314150296392	10	278
BPC815	7314150296385	1	278
BPC815K1*	7314150331208	1	279
BPC815K2	7314150331215	1	279
BPC815K3*	7314150331222	1	279
BPC815K4*	7314150331239	1	279
BPC815K6*	7314150331284	1	279
BPC817	7314150296422	4	279
BPC817K1*	7314150331260	1	279
BPC817K2*	7314150331277	1	280
BPC823*	7314150427147	1	285
BPC825*	7314150427154	1	285
BPCVB1	7314150384792	6	329
BPG824*	7314150427253	10	286
BPH1010A	7314150330010	1	290
BPH1010B	7314150341757	1	290
BPH1310A	7314150330003	1	290
BPHRC1015	7314150247400	1	290
BPHRC1020	7314150247417	1	290
BPHRC1316	7314150247455	1	290
BPHRC815	7314150247394	1	290
BPHRSC	7314150247448	1	290
BPHVLP01	7314150138937	1	288
BPHVLP0112	7314150165872	1	288
BPHVLP0114	7314150165889	1	288
BPHVLP0117	7314150165896	1	288
BPHVLP0120	7314150165902	1	288
BPN010	7314150219728	1	289
BPN21201	7314150134731	1	285
BPN22201	7314150138074	1	285
BPN251	7314150137589	1	289
BPOC15	7314150360673	12	310
BPSJ	7314150427239	1	290
BPSJL	7314150439812	1	290
BS1000	7314150170081	1	331
BS100001	7314150232819	1	331
BS100002	7314150232826	1	331
BS100003	7314150232833	1	331
BS100004	7314150232840	1	331
BS100005	7314150232857	1	331
BS100006	7314150232864	1	331
BS100007	7314150232871	1	331
BS100008	7314150232888	1	331
BS100009	7314150232895	1	331
BS100010	7314150232901	1	331
BS100011	7314150232918	1	331
BS100012	7314150232925	1	331
BS100013	7314150232932	1	331
BS100014	7314150232949	1	331
BS100015	7314150232956	1	331
BS100016	7314150232963	1	331
BS100017	7314150232970	1	331
BS100018	7314150232987	1	331
BS100019	7314150232994	1	331
BS100020	7314150233007	1	331
BS100021	7314150233014	1	331
BS100022	7314150233021	1	331
BS100023	7314150233038	1	331
BS100024	7314150233045	1	331
BS100025	7314150233052	1	331
BS100026	7314150233069	1	331
BS100027	7314150233076	1	331
BS100028	7314150233083	1	331
BS100029	7314150233090	1	331
BS100030	7314150233106	1	331
BS100031	7314150233113	1	331
BS100032	7314150233120	1	331
BS100033	7314150233137	1	331
BS100034	7314150233144	1	331
BS100035	7314150233151	1	331
BS100036	7314150233168	1	331
BS100037	7314150233175	1	331
BS100038	7314150233182	1	331
BS100039	7314150233199	1	331
BS100PSA1	7314150249282	1	330
BS10AC2	7314150182343	1	331
BS15	7314150206117	1	331
BS25	7314150416103	1	331
BS30AC1	7314150383504	1	331
BS30PG	7314150436644	1	331
BS40VAG	7314150430642	20	329
BS45BMW*	7314150430659	20	329
BS52	7314150329212	1	329
BS5228341	7314150329229	1	328
BS5234401	7314150329236	1	328
BS5239451	7314150329243	1	328
BS54	7314150243341	1	329
BS56*	7314150430826	6	329
BS618	7314150242368	1	330
BS623	7314150242375	1	330
BSSHE3	7314150251858	1	328
BT10P3	7314150205639	1	338
BT10P325	7314150231706	40	339
BT10P330	7314150231713	1	339



BT10P338	7314150231720	1	339
BT15P5	7314150205837	1	327
BT15P524	7314150231737	1	327
BT15P530	7314150231744	1	327
BT15P532	7314150231751	1	327
BT15P536	7314150342129	1	327
BT20P26	7314150205820	1	329
BT20P49	7314150385041	1	330
BTL-3-13	7314150333349	12	526
BTL-6-13	7314150333356	12	526
BTR-3-13	7314150333332	12	526
BTR-6-13	7314150333363	12	526
BUC100	7314150169962	1	315
BUC110	7314150206025	1	315
BUC50	7314150182329	1	314
BUCKET - 1446-CS	7314150534555	1	571
BUCKET - EMPTY	7314150511037	6	571
BUCKET-1446-FLOAT	7314150539550	1	571
BUCPE	7314150243259	1	314
BUCPE3SDH	7314153024183	1	314
BUCPE3SH	7314150243471	1	314
BUCPEF	7314150244942	1	314
BUCPEF1	7314150245116	1	314
BWB14	7314150170166	2	329
BWB1418S4	7314150365593	6	337
BWB1922S4*	7314150365609	6	337
BWBB	7314150407828	200	325
BWC1	7314150365586	25	326
BWHEHS	7314150251841	1	328
BWHEP	7314150251834	1	328
BWHEPS	7314150264087	1	327
BWHEPSH8	7314150264889	1	327
BWHEPSSH8	7314150264896	1	327
BWHPJ12	7314150403257	4	330
BWHTRS12*	7314150384808	15	325
BWMS15	7314150239740	1	363
BWMS1501	7314150239757	1	363
BWMS1502	7314150239764	1	363
BWMS1503	7314150239771	1	363
BWMS1504	7314150239788	1	363
BWMS1505	7314150239795	1	363
BWMS1506	7314150239801	1	363
BWMS1507	7314153024176	1	363
BWMS1508	7314150239818	1	363
BWMS1509	7314150239825	1	363
BWMS1510	7314150239832	1	363
BWMS1511	7314150239849	1	363
BWMS1512	7314150239856	1	363
BWMS1513	7314150239863	1	363
BWMS1514	7314150239870	1	363
BWMS1515	7314150239887	1	363
BWP150	7314150170159	1	326
BWSH5	7314150251810	2	328
BWSH51	7314150251827	1	328
BWSH8	7314150255191	1	328
BWSHK21	7314150403271	25	324
BWSMB15	7314150365074	25	324
BWSMB17	7314150329656	1	323
BWSS12P3	7314150170128	20	323
BWSS12P317	7314150203451	1	323
BWSS12P317L	7314150330065	1	324
BWSS12P319	7314150203468	1	323
BWSS12P319L	7314150330072	1	324
BWSS12P321	7314150203475	1	323
BWSS12P321L*	7314150330089	1	324
BWSS12P3L	7314150330096	1	324
BWSS12P5	7314150170135	1	323
BWSS12P522	7314150203482	1	323
BWSS12P524	7314150203499	1	323
BWTB12P100	7314150329830	1	325
BWTB12P110	7314150329847	1	325
BWTB12P120	7314150329854	1	325
BWTB12P135	7314150329861	1	325
BWTB12P150	7314150329878	1	325
BWTB12P160	7314150329885	1	325
BWTB12P175	7314150329892	1	325
BWTB12P190	7314150329908	1	325
BWTB12P200	7314150329915	1	325
BWTB12P5	7314150329991	1	325
BWTB12P90	7314150329823	1	325
BWTDG1	7314150403400	50	326
BWTPG1*	7314150351886	10	326
BWTPMSS4C	7314150347100	25	327
BWTPMSS9	7314150347124	8	326
BWTSP16	7314150170296	1	325
BWTSP1608	7314150203284	1	325
BWTSP1610	7314150203291	1	325
BWTSP1611	7314150203307	1	325
BWTSP1612	7314150203314	1	325
BWTSP1613	7314150203321	1	325
BWTSP1614	7314150203338	1	325
BWTSP1616	7314150203345	1	325
BWTSP1617	7314150203352	1	325
BWTSP1618	7314150203369	1	325
BWTSP1619	7314150203376	1	325
BWTSP1621	7314150203383	1	325



BWTSP1622	7314150203390	1	325
BWTSP1624	7314150203406	1	325
BWTSP1627	7314150203413	1	325
BWTSP317L	7314150335480	1	324
BWTSP319L	7314150335497	1	324
BWTSP321L	7314150335503	1	324
BWTSP3L	7314150335473	1	324
BWTSP6	7314150240043	1	324
BWTSP617	7314150242399	1	324
BWTSP619	7314150242405	1	324
BWTSP621	7314150242412	1	324
BWTSP622	7314150242429	1	324
BWTSP624	7314150242436	1	324
BWTSP7	7314150170302	1	324
BWTSP732	7314150203420	1	325
BWTSP736	7314150203437	1	325
BWTSP741	7314150203444	1	325
BWTVCTT355	7314150347179	1	326
BWXW1	7314150167661	1	323
BWXW2	7314150167678	4	323
BWXW3	7314150214624	1	323
BWXW4	7314150214631	1	323
BZWTB0132450*	7314150165674	1	325
BZWTB0132600*	7314150165681	1	325
C0312I03	7314150501298	5	153
C0313M03	7311518100636	1	150
C0313M03X	7311518182045	1	150
C0616AL06	7311518181826	1	151
C0616M03X	7311518204679	1	150
C0616M06	7311518100667	1	150
C0616M06X	7311518100681	1	150
C0618I06	7314150501311	5	153
C0618S06	7314150501342	5	152
C0820M06	7311518100711	1	150
C0820M06X	7311518100735	1	150
C1020I06	7314150501373	5	153
C1020M06	7311518100766	1	150
C1020M06X	7311518100780	1	150
C1020S06	7314150501403	5	152
C1225AL06	7311518187637	1	151
C1225I06	7314150506743	5	153
C1225M06	7311518100810	1	150
C1225M06X	7311518100834	1	150
C1225M08X	7311518187996	1	150
C1225S06	7314150501465	5	152
C1625M06	7311518192266	1	150
C1625M06X	7311518187378	1	150
C1625M08	7311518100902	1	150
C1625M08X	7311518100926	1	150
C1997LM/9P	7314150510375	1	231
C1997TORX/9P	7314150510382	1	232
C3230IP*	7314150391189	10	241
C3330R IP*	7314150391202	10	238
C3340R IP	7314150391219	10	238
C3430	7314150393367	10	249
C3430IP	7314150391226	10	249
C3530	7314150393374	10	250
C3530IP	7314150391233	10	250
C3630	7314150393381	10	245
C3630IP	7314150391240	10	245
C3640	7314150393398	10	245
C3640IP	7314150391257	10	245
C3745	7314150393404	10	247
C3745IP	7314150391264	10	247
C3790	7314150393411	10	247
C3790IP	7314150391271	10	247
C3830	7314150393428	10	245
C3830IP	7314150391288	10	245
C3840*	7314150393435	10	245
C3840IP	7314150391295	10	245
C3902/3	7314150399604	1	261
C3903/2-6	7314150466481	1	261
CFP250	7314150400669	6	598
CFP250-DISP*	7314150400690	12	598
CHALK-BLUE	7314150128686	6	530
CHALK-RED	7314150128709	6	530
CHALK-WHITE	7314150179671	6	530
CHALK-YELLOW	7314150128693	6	530
CL-1221	7314150127112	6	530
CL-1221-SET	7314150188574	4	530
CL-1331	7314150347728	48	530
CL-1441	7314150347735	36	530
CL-1441-SET	7314150360758	16	530
CLIPS-1/2	7314153003201	25	99
CLIPS-1/4	7314153003188	25	85
CLIPS-3/8	7314153003195	25	92
CR B 01	7314150215409	60	258
CR B 02	7314150215416	60	258
CR B 03	7314150215423	60	258
CR B 05	7314150215454	2	258
CR B 06	7314150215461	2	258
CR L 01	7314150215911	1	260
CR L 02	7314150215928	1	260
CR L 03	7314150215935	1	260
CR OV 01	7314150489978	1	258
CR SA H01	7314150489992	1	260

* Until stocks last



CR SA H16	7314150508990	1	260
CR SA S01	7314150490011	1	260
CR SA T01	7314150490035	1	260
CR W 01	7314150215492	1	259
CR W 02	7314150215508	1	259
CR W 03	7314150215515	1	259
CR W 04	7314150215522	1	259
CR W 05	7314150215539	1	259
CR W 06	7314150215546	1	259
CS-SPARE	7314150453030	1	532
CS150	7314150125241	12	532
CS300	7314150125258	12	532
CS400	7314150125265	12	532
D-DD/S20	7311518280345	4	185
D/S10	7311518280307	6	185
D/S14	7311518280314	6	185
D0303I03	7314150501281	5	150
D0303M03	7311518100957	1	150
D0303M03X	7311518182052	1	150
D0605M03X	7311518197896	1	150
D0606I06	7314150501328	5	153
D0606M06	7311518100988	1	150
D0606M06X	7311518101008	1	150
D0606S06	7314150501359	5	152
D0807M06	7311518043896	1	150
D0807M06X	7311518043919	1	150
D1009M06	7311518035280	1	150
D1009M06X	7311518035297	1	150
D1009M06X-69	7311518224288	1	150
D1010I06	7314150501380	5	153
D1010S06	7314150501410	5	152
D1211AL06	7311518187644	1	151
D1211AL08	7311518181840	1	151
D1211M06	7311518035334	1	150
D1211M06X	7311518035358	1	150
D1212I06	7314150501441	5	153
D1212S06	7314150501472	5	152
D1614M06	7311518192327	1	150
D1614M06X	7311518187385	1	150
D1614M08	7311518035389	1	150
D1614M08X	7311518035402	1	150
DD/S10	7311518280321	6	185
DD/S14	7311518280338	4	185
DOW 175-1	7314152202728	1	270
DOW 175-11/2	7314152202995	1	270
DOW 175-2	7314152203022	1	270
DOW 175-3	7314152203299	1	270
DOW 176-1	7314152206047	1	271
DOW 176-11/2	7314152206122	1	271
DOW 176-2	7314152206399	1	271
DOW 177-1/2-1	7314152816383	1	270
DOW 177-11/2	7314152816468	1	270
DOW 177-2	7314152816543	1	270
E0308M03	7311518035433	1	150
E0308M03X	7311518192372	1	150
E0614M06	7311518035464	1	150
E0816M06	7311518035518	1	150
E0816M06X	7311518035532	1	150
E1015I06	7314150501496	5	153
E1018M06	7311518035563	1	150
E1018M06X	7311518035587	1	150
E1220I06	7314150501526	5	153
E1222M06	7311518035617	1	150
E1222M06X	7311518035631	1	150
E1222M08	7311518172558	1	150
E1222M08X	7311518199302	1	150
E1625M06	7311518192440	1	150
E1625M06X	7311518187392	1	150
E1625M08	7311518035709	1	150
E1625M08X	7311518035723	1	150
EDGE-LAUNCH1	7314150545230	1	628
EX-14-TEN-C	7311518298333	5	551
EX-14-VEN-C	7311518298340	10	551
EX-16-GNP-C	7311518298685	10	548
EX-19-XT9-C	7311518298302	10	550
EX-20-LAM-C	7311518298326	10	551
EX-20-XT11-C	7311518298319	10	551
EX-22-PLS-C	7311518298357	10	548
EX-22-U7	7311518300890	10	550
EX-22-XT7-C	7311518298289	10	552
EX-22-XT9-C	7311518298296	10	550
EX-24-XT7-C	7311518298272	10	550
EX-244P-22	7311518298456	10	552
EX-LL	7311518298494	4	554
EX-NPP-22	7311518324162	10	550
EX-RL	7311518298487	4	554
EX-RM	7311518298470	4	554
F0312I03	7314150501502	5	153
F0313M03	7311518035754	1	150
F0313M03X	7311518192495	1	150
F0613M03X	7311518196608	1	150
F0618AL06	7311518181857	1	150
F0618I06	7314150501533	5	153
F0618M06	7311518035792	1	150
F0618M06X	7311518035815	1	150
F0618S06	7314150501564	5	152





F0820M06	7311518035839	1	150
F0820M06X	7311518035860	1	150
F1020I06	7314150501595	5	153
F1020M06	7311518035891	1	150
F1020M06X	7311518035914	1	150
F1020S06	7314150501625	5	152
F1225AL06	7311518187651	1	152
F1225AL08	7311518181864	1	152
F1225I06	7314150501656	5	153
F1225M06	7311518035945	1	150
F1225M06X	7311518036003	1	150
F1225M08	7311518035983	1	150
F1225M08X	7311518192563	1	150
F1225S06	7314150501687	5	152
F1625M06	7311518192570	1	150
F1625M06X	7311518187408	1	150
F1625M08	7311518036034	1	150
F0820M06	7311518123970	4	586
F0820M06X	7311518123994	2	586
F0820M06	7314150321551	6	533
F0820M06X	7314150321537	6	533
F0820M06	7314150321544	6	533
F0820M06	7314150228560	1	388
F0820M06	7314150228591	1	388
F0820M06	7314150228607	1	388
F0820M06	7314150227778	1	389
F0820M06	7314150478446	1	389
F0820M06	7314150227822	1	389
F0820M06	7314150227846	1	389
F0820M06	7314150227976	1	390
F0820M06	7314150227990	1	390
F0820M06	7314150286454	1	390
F0820M06	7314150339068	1	390
F0820M06	7314150334841	1	390
F0820M06	7314150335541	1	391
F0820M06	7314150228034	1	391
F0820M06	7314150335619	1	391
F0820M06	7314150335572	1	391
F0820M06	7314150335633	1	391
F0820M06	7314150335640	1	391
F0820M06	7314150335701	1	392
F0820M06	7314150228058	1	392
F0820M06	7314150335718	1	392
F0820M06	7314150335725	1	392
F0820M06	7314150336395	1	392
F0820M06	7314150228072	1	392
F0820M06	7314150336661	1	393
F0820M06	7314150336678	1	393
F0820M06	7314150336685	1	393
F0820M06	7314150336692	1	393
F0820M06	7314150336708	1	393
F0820M06	7314150336715	1	394
F0820M06	7314150336722	1	394
F0820M06	7314150336739	1	394
F0820M06	7314150336746	1	394
F0820M06	7314150336753	1	394
F0820M06	7314150228089	1	395
F0820M06	7314150336777	1	395
F0820M06	7314150338580	1	395
F0820M06	7314150338603	1	395
F0820M06	7314150338610	1	395
F0820M06	7314150228096	1	396
F0820M06	7314150350445	1	396
F0820M06	7314150228102	1	396
F0820M06	7314150350995	1	396
F0820M06	7314150351800	1	396
F0820M06	7314150228126	1	396
F0820M06	7314150358694	1	397
F0820M06	7314150254354	1	397
F0820M06	7314150431496	1	397
F0820M06	7314150455850	1	383
F0820M06	7314150455874	1	383
F0820M06	7314150455881	1	383
F0820M06	7314150455898	1	383
F0820M06	7314150455904	1	384
F0820M06	7314150254361	1	397
F0820M06	7314150455928	1	384
F0820M06	7314150455935	1	384
F0820M06	7314150455966	1	384
F0820M06	7314150455973	1	384
F0820M06	7314150455980	1	384
F0820M06	7314150455997	1	385
F0820M06	7314150456000	1	385
F0820M06	7314150456017	1	385
F0820M06	7314150456024	1	385
F0820M06	7314150456031	1	385
F0820M06	7314150456062	1	385
F0820M06	7314150456079	1	386
F0820M06	7314150456086	1	386
F0820M06	7314150437283	1	386
F0820M06	7314150456093	1	386
F0820M06	7314150456109	1	386
F0820M06	7314150456123	1	387
F0820M06	7314150456130	1	387
F0820M06	7314150456147	1	387
F0820M06	7314150254385	1	397



FF1A220LM	7314150456154	1	387
FF1A221LM	7314150456161	1	387
FF1A222LM	7314150456178	1	387
FF1A223LM	7314150456185	1	388
FF1A224LM	7314150456192	1	388
FF1A225LM	7314150456208	1	388
FF1A23	7314150254392	1	398
FF1A230	7314150461455	1	398
FF1A230I	7314150286508	1	398
FF1A235	7314150500666	1	398
FF1A236	7314150500680	1	398
FF1A24	7314150254408	1	398
FF1A25	7314150254415	1	399
FF1A250I	7314150286492	1	399
FF1A2503	7314150320677	1	399
FF1A26	7314150254422	1	399
FF1A28	7314150254446	1	400
FF1A300I	7314150286515	1	400
FF1A3002	7314150289264	1	400
FF1A3003	7314150286522	1	400
FF1A3004	7314150286676	1	400
FF1A3005	7314150286638	1	400
FF1A36	7314150265862	1	400
FF1A37	7314150265855	1	401
FF1A400I	7314150286713	1	401
FF1A4002	7314150286560	1	401
FF1A4003	7314150286706	1	401
FF1A48	7314150271801	1	401
FF1A50	7314150271825	1	401
FF1A5002	7314150286447	1	402
FF1A5003	7314150286690	1	402
FF1A5004	7314150286539	1	402
FF1A5005	7314150286546	1	402
FF1A5006	7314150286683	1	403
FF1A5007	7314150286553	1	403
FF1A5008	7314150286607	1	403
FF1A5009	7314150286669	1	403
FF1A5010	7314150286584	1	403
FF1A5011	7314150286614	1	404
FF1A5012	7314150286652	1	404
FF1A5013	7314150286577	1	404
FF1A5019	7314150309436	1	404
FF1A5021	7314150309467	1	404
FF1A5022	7314150309474	1	404
FF1A5023	7314150309498	1	405
FF1A5024	7314150309504	1	405
FF1A5028	7314150320691	1	405
FF1A5032	7314150320738	1	405
FF1A5036	7314150339037	1	406
FF1A51	7314150271832	1	406
FF1A54	7314150288786	1	406
FF1A65	7314150313389	1	406
FF1A66	7314150313396	1	406
FF1A67	7314150313402	1	406
FF1A68	7314150313419	1	406
FF1A70	7314150320189	1	407
FF1A71	7314150320196	1	407
FF1A72	7314150320202	1	407
FF1A82	7314150334070	1	407
FF1ASET-AUTO	7314150437993	1	381
FF1ASET-AUTO-M1	7314150438259	1	382
FF1ASET-AUTO-M2	7314150438327	1	382
FF1ASET-AUTO-M3	7314150438334	1	382
FF1ASET-AUTO-M4	7314150438341	1	382
FF1ASET-AUTO-M5	7314150438358	1	383
FF1ASET-AUTO-M6	7314150438365	1	383
FF1ASET-AUTO1	7314150254453	1	381
FF1ASET-AUTO2	7314150254460	1	381
FF1ASET-AUTO3	7314150254477	1	381
FF1ASET-AUTO6	7314150319909	1	382
FF1ASET-BASIC	7314150437368	1	380
FF1ASET-LARGE	7314150437108	1	380
FF1ASET-MRO2	7314150336623	1	380
FF1ASET-MRO3	7314150336630	1	380
FF1ASET-MRO4	7314150336647	1	381
FF1ASET-MRO5	7314150336654	1	381
FF1ASET-XLARGE	7314150436965	1	380
FF1B01LM	7314150455416	1	378
FF1B02LM	7314150455447	1	378
FF1B03LM	7314150455454	1	378
FF1B04LM	7314150455478	1	378
FF1B05LM	7314150455515	1	379
FF1B06LM	7314150455522	1	379
FF1B07LM	7314150455614	1	379
FF1B08LM	7314150455645	1	379
FF1B09LM	7314150455669	1	379
FF1B10LM	7314150455706	1	380
FF1B11LM	7314150455713	1	380
FF1BSET-MONSTER	7314150436835	1	377
FF1E1001	7314150285839	1	414
FF1E1002	7314150285761	1	414
FF1E1003	7314150285853	1	414
FF1E1004	7314150285754	1	414
FF1E1005	7314150285785	1	414
FF1E1006	7314150285778	1	414
FF1E1007	7314150285792	1	414



FF1E1008	7314150285822	1	414
FF1E1009	7314150285808	1	414
FF1E1009EH	7314150352579	1	422
FF1E1010	7314150285815	1	415
FF1E1011	7314150285846	1	415
FF1E1012EH	7314150352562	1	421
FF1E1013EH	7314150352586	1	422
FF1E2001	7314150285945	1	415
FF1E2002	7314150285921	1	415
FF1E2003	7314150286072	1	415
FF1E2004	7314150285952	1	415
FF1E2005	7314150285976	1	416
FF1E2006	7314150285914	1	416
FF1E2007	7314150285907	1	416
FF1E2008	7314150285860	1	416
FF1E2009EH	7314150352593	1	422
FF1E2010EH	7314150352654	1	422
FF1E2011EH	7314150373802	1	423
FF1E2101	7314150285877	1	416
FF1E2102	7314150286058	1	416
FF1E2103	7314150286089	1	417
FF1E2104	7314150285990	1	417
FF1E2105	7314150286041	1	417
FF1E2106EH	7314150352623	1	422
FF1E2107EH	7314150352661	1	422
FF1E2201	7314150286010	1	417
FF1E2202	7314150285891	1	417
FF1E2203	7314150285884	1	417
FF1E2204	7314150285983	1	418
FF1E2205	7314150285938	1	418
FF1E2206	7314150286034	1	418
FF1E2207	7314150285969	1	418
FF1E2208	7314150286027	1	418
FF1E2209	7314150286096	1	418
FF1E2210	7314150286065	1	418
FF1E2211	7314150339006	1	419
FF1E2212	7314150339013	1	419
FF1E2213	7314150339020	1	419
FF1E2214EH	7314150352647	1	422
FF1E2215EH	7314150352678	1	422
FF1E2216EH	7314150373833	1	423
FF1E2501	7314150286003	1	419
FF1E2502	7314150338993	1	419
FF1E2503EH	7314150352685	1	422
FF1E2504EH	7314150374106	1	423
FF1E2505EH	7314150373826	1	424
FF1E3001	7314150286119	1	420
FF1E3002	7314150286102	1	420
FF1E3003	7314150286157	1	420
FF1E3004	7314150286133	1	420
FF1E3005	7314150286126	1	420
FF1E3006	7314150286140	1	420
FF1E3007	7314150286164	1	420
FF1E3008	7314150286171	1	420
FF1E3009EH	7314150352722	1	422
FF1E3010EH	7314150352739	1	422
FF1E3011EH	7314150352753	1	423
FF1E4001	7314150285747	1	421
FF1E4002	7314150285730	1	421
FF1E4003EH	7314150352692	1	423
FF1E4004EH	7314150352708	1	423
FF1E4005EH	7314150352807	1	423
FF1E5001	7314150285716	1	421
FF1E5002	7314150285709	1	421
FF1E5003	7314150285723	1	421
FF1E5004	7314150338931	1	421
FF1E5005	7314150338948	1	419
FF1E5006	7314150338955	1	419
FF1E5007	7314150338962	1	421
FF1E5008	7314150338979	1	421
FF1E5009	7314150338986	1	420
FF1E5010EH	7314150352746	1	423
FF1E5011EH	7314150352777	1	423
FF1E5013EH	7314150352821	1	423
FF1E5014EH	7314150373864	1	424
FF1E5015EH	7314150373871	1	424
FF1E5016EH	7314150373888	1	424
FF1F1001	7314150286270	1	407
FF1F1002	7314150286287	1	407
FF1F1003	7314150286294	1	408
FF1F1004	7314150286263	1	408
FF1F1005	7314150286300	1	408
FF1F1006	7314150286249	1	408
FF1F1007	7314150286256	1	408
FF1F1008	7314150339129	1	408
FF1F1009	7314150339136	1	408
FF1F2001	7314150286317	1	409
FF1F2002	7314150339143	1	409
FF1F2101	7314150286331	1	409
FF1F2102	7314150339105	1	409
FF1F2103	7314150339112	1	409
FF1F2201	7314150286324	1	409
FF1F2202	7314150339150	1	410
FF1F2203	7314150339167	1	410
FF1F3001	7314150286348	1	410
FF1F3002	7314150286379	1	410



FF1F3003	7314150286409	1	410
FF1F3004	7314150286386	1	410
FF1F3005	7314150286362	1	411
FF1F3006	7314150286355	1	411
FF1F3007	7314150286393	1	411
FF1F3008	7314150286423	1	411
FF1F3009	7314150286416	1	411
FF1F3010	7314150339082	1	411
FF1F3011	7314150339099	1	411
FF1F4001	7314150286195	1	411
FF1F4002	7314150286201	1	412
FF1F4003	7314150286225	1	412
FF1F4004	7314150286232	1	412
FF1F4005	7314150286218	1	412
FF1F5001	7314150286188	1	412
FF1F5002	7314150339174	1	412
FF1F5003	7314150339181	1	412
FF1F5004	7314150339198	1	410
FF1F5005	7314150339204	1	413
FF1F5006	7314150339211	1	413
FF1F5007	7314150339228	1	413
FF1F5008	7314150339235	1	413
FF1F5009	7314150339242	1	413
FF1F5010	7314150339259	1	413
FF1F5011	7314150339266	1	413
FF1F5012	7314150339273	1	413
FF1F5013	7314150339280	1	410
FF2A07	7314150228201	1	431
FF2A08	7314150228225	1	432
FF2A09	7314150228249	1	432
FF2A10	7314150228263	1	432
FF2B01	7314150233441	1	432
FF2B02	7314150233465	1	432
FF2B03	7314150233489	1	433
FF2B04	7314150233502	1	433
FF2B05	7314150233526	1	433
FF2B06	7314150233540	1	433
FF2B07	7314150229420	1	433
FF2B08	7314150229451	1	433
FF2B09	7314150229482	1	434
FF2B10	7314150229505	1	434
FF2B11	7314150229529	1	434
FF2B12	7314150229543	1	434
FF2B13	7314150229567	1	434
FF2B14	7314150229581	1	434
FF2B15	7314150229604	1	435
FF2B16	7314150229628	1	435
FF2C01	7314150327287	1	435
FF3A01	7314150228300	1	443
FF3A02	7314150228324	1	444
FF3A03	7314150228348	1	444
FF3A04	7314150228362	1	444
FF3A05	7314150228386	1	444
FF3A06	7314150228416	1	444
FF3A07	7314150228430	1	445
FF3A08	7314150228454	1	445
FF3A09	7314150228478	1	445
FF3A10	7314150228492	1	445
FF3A11	7314150228515	1	445
FF3A12	7314150228539	1	446
FF3A13	7314150228614	1	446
FF3A14	7314150228638	1	446
FF3A15	7314150228652	1	446
FF3A16	7314150228676	1	446
FF3A17	7314150228690	1	447
FFSS-1.5-900FG	7311518275884	4	586
FGS-1.0-600	7311518123796	4	586
FGS-1.25-700	7311518123802	4	586
FGS-1.25-700-WB	7314150398720	4	586
FGS-1.6-810	7311518123819	4	586
FGS-1.6-810-WB	7314150399086	4	586
FGS-1.8-810	7311518123826	4	586
FM10	7311518010881	5	33
FM12	7314150273249	5	33
FP-3M	7311518168612	1	613
FS-5	7311518266455	10	618
FS-7.5	7311518266479	10	618
FS-8	7311518266462	10	618
G0313M03	7311518036089	1	150
G0313M03X	7311518182069	1	150
G0613M03X	7311518196592	1	150
G0618M06	7311518036119	1	150
G0618M06X	7311518036133	1	150
G0820M06	7311518036164	1	150
G0820M06X	7311518036188	1	150
G1020I06	7314150501519	5	153
G1020M06	7311518036218	1	150
G1020M06X	7311518036232	1	150
G1020S06	7314150501540	5	152
G1225I06	7314150501571	5	153
G1225M06	7311518036317	1	150
G1225M06X	7311518036331	1	150
G1225M08	7311518036362	1	150
G1225M08X	7311518188009	1	150
G1225S06	7314150501601	5	152
G1625M06	7311518192648	1	150

* Until stocks last



G1625M06X



G1625M06X	7311518187415	1	150
G1625M08	7311518036409	1	150
G1625M08X	7311518036423	1	150
GL008-10	7314150167050	5	478
GL008-8	7314150167043	5	478
GL010-10	7314150167098	5	478
GL010-8	7314150167081	5	478
GS-180-F	7311518275488	6	618
GS-76	7311518010782	8	617
H0613M03X	7311518196615	1	150
H1020I06	7314150501717	5	153
H1025M06	7311518182304	1	150
H1025M06X	7311518182311	1	150
H1232I06	7314150501748	5	153
H1232M06	7311518182076	1	150
H1232M06X	7311518181758	1	150
H1635M06	7311518192730	1	150
H1635M06X	7311518187422	1	150
H1635M08	7311518182083	1	150
H1635M08X	7311518182090	1	150
HFGPS-0.7-400FG	7311518275877	4	586
HGPS-0.6-360	7311518123680	10	586
HGPS-0.8-380	7311518123697	4	586
HGPS-0.8-380-WB	7314150398812	4	586
HGPS-1.0-400	7311518123703	4	586
HGPS-1.0-400-WB	7314150398713	4	586
HRFM10	7311518010898	5	33
HS6000	7314150113781	10	633
HS6001	7314150476466	10	633
HUS-0.6-380	7311518123659	4	586
HUS-0.8-500	7311518123666	4	586
HUS-1.0-650	7311518123673	4	586
IZO-D-135	7314151845827	1	111
IZO-D-200	7314151846831	1	111
IZO-D-30	7314151846824	1	111
IZO-D-340	7314151846848	1	111
IZO-DR-810	7314151846817	1	112
J0604M06	7311518036508	1	151
J1010M06	7311518172473	1	151
J1212M06	7311518036577	1	151
J1616M06	7311518187439	1	151
J1616M08	7311518036614	1	151
K-AP-1	7311518030117	10	623
K-GP-1	7311518030131	10	623
K0602M06	7311518036652	1	151
K1008M06	7311518036683	1	151
K1210M06	7311518036720	1	151
K1612M06	7311518193959	1	151
K1612M08	7311518036768	1	151
K172	7314150384396	1	180
K18NF-2	7314151347161	5	177
K18PH-2M5	7314153019646	5	177
K18PH-2M6	7314150274871	5	177
K19PZD-2M5	7314151693237	1	177
K19PZD-2NF	7314151586157	1	177
K20TORX-T25	7314151825799	10	177
K560F-1	7314151825492	5	180
K560F-2	7314151825324	5	181
K560F-3	7314151825331	5	181
K560F-4	7314151825348	5	184
K560F-5	7314151825355	5	184
K560F-6	7314151825362	5	187
K560F-7	7314151825379	5	189
K560F-8	7314151825508	5	189
K560F-9	7314151846688	5	191
K66100-1/4	7314150204540	1	179
K66100-1/4P-1P	7314150533244	20	179
K66100-3/8	7314150204564	1	179
K66100-3/8-1P	7314150260249	25	179
K6625-1/4B-1P	7314150533282	80	179
K6625-1/4B-5P	7314150533305	50	179
K6638-3/8	7314150204557	1	179
K6638-3/8-1P	7314150260164	25	179
K6650-1/2P-1P	7314150533343	20	179
K6650-1/2P-5P	7314150533367	25	179
K6650-1/4B-1P	7314150533381	20	179
K6650-1/4P-5P	7314150533404	50	179
K6650-3/8P-1P	7314150533428	20	179
K6650-3/8P-5P	7314150533442	25	179
K6660-QR-1P	7314150204571	1	179
K6701M-10	7314151778149	1	179
K6701M-11	7314151778224	1	179
K6701M-12	7314151811891	1	179
K6701M-13	7314151778491	1	179
K6701M-14	7314151844172	1	179
K6701M-6	7314151813260	1	179
K6701M-7	7314151777920	1	179
K6701M-8	7314151778064	1	179
K6701M-9	7314151815110	1	179
K6750-1/4	7314150204663	1	177
K6750-10-1P	7314150533466	20	177
K6750-13	7314150204823	1	177
K6750-3/8	7314150204656	1	177
K6750-6	7314150204670	1	177
K6750-7*	7314150204687	1	177
K6750-8-1P	7314150533541	20	177



K6964C	7314151215170	1	181
K7401M-10	7314151780128	1	180
K7401M-11	7314151780395	1	180
K7401M-12	7314151811907	1	180
K7401M-13	7314151780470	1	180
K7401M-14	7314151780555	1	180
K7401M-15	7314151812140	1	180
K7401M-16	7314151780630	1	180
K7401M-17	7314151780715	1	180
K7401M-18	7314151812157	1	180
K7401M-19	7314151812164	1	180
K7401M-20	7314151844271	1	180
K7401M-21	7314151845216	1	180
K7401M-22	7314151845223	1	180
K7401M-24	7314151844295	1	180
K7401M-7	7314151812126	1	180
K7401M-8	7314151780043	1	180
K7401M-9	7314151812133	1	180
K7401M10	7314150389919	1	181
K7401TORX-E-S7*	7314150343324	1	182
K7401TORX-E10*	7314151844448	1	181
K7401TORX-E12*	7314151844455	1	181
K7401TORX-E14*	7314151844462	1	181
K7401TORX-E5*	7314151844400	1	181
K7401TORX-E6*	7314151844417	1	181
K7401TORX-E7*	7314151844424	1	181
K7401TORX-E8*	7314151844431	1	181
K7401Z-1/2*	7314150384402	1	180
K7401Z-11/16*	7314150384419	1	180
K7401Z-13/16*	7314150384426	1	180
K7401Z-3/4*	7314150384433	1	180
K7401Z-3/8*	7314150384440	1	180
K7401Z-5/8*	7314150384457	1	180
K7401Z-7/16*	7314150384464	1	180
K7401Z-7/8*	7314150384471	1	180
K7401Z-9/16*	7314150384488	1	180
K7406M-10	7314151844479	1	180
K7406M-13	7314151844486	1	180
K7406M-17	7314151844493	1	180
K7760C-1	7314151222369	1	181
K7760C-2	7314151222376	1	181
K7764D	7314151222475	1	184
K7767S	7314151222512	1	181
K7800M-10	7314150326297	1	182
K7800M-11	7314150326303	1	182
K7800M-12	7314150326310	1	182
K7800M-13	7314150326327	1	182
K7800M-14	7314150326334	1	182
K7800M-15	7314150326341	1	182
K7800M-16	7314150326358	1	182
K7800M-17	7314150326365	1	182
K7800M-18	7314150326372	1	182
K7800M-19	7314150326389	1	182
K7800M-21	7314150326396	1	182
K7800M-22	7314150326402	1	182
K7800M-24	7314150326419	1	182
K7800M13	7314150437221	1	184
K7801M-10	7314151778576	1	182
K7801M-11	7314151778651	1	182
K7801M-12	7314151815790	1	182
K7801M-13	7314151778736	1	182
K7801M-14	7314151778811	1	182
K7801M-15	7314151815806	1	182
K7801M-16	7314151779030	1	182
K7801M-17	7314151779115	1	182
K7801M-18	7314151779382	1	182
K7801M-19	7314151779467	1	182
K7801M-20	7314151844509	1	182
K7801M-21	7314151779542	1	182
K7801M-22	7314151779627	1	182
K7801M-23	7314151844516	1	182
K7801M-24	7314151779894	1	182
K7801M-25	7314151844523	1	182
K7801M-26	7314151844530	1	182
K7801M-27	7314151779979	1	182
K7801M-28	7314150430154	1	182
K7801M-29	7314150430161	1	182
K7801M-30	7314151811914	1	182
K7801M-32	7314151825157	15	182
K7801M-34	7314151844547	1	182
K7801M-36	7314151844554	1	182
K7801M-8	7314151845230	1	182
K7801M-9	7314151845247	1	182
K7801TORX-E10	7314151811587	1	184
K7801TORX-E12	7314151811594	1	184
K7801TORX-E14	7314151811600	1	184
K7801TORX-E16	7314151811617	1	184
K7801TORX-E18	7314151811624	1	184
K7801TORX-E20	7314151811631	1	184
K7801TORX-E24	7314151811648	1	184
K7801Z-1	7314151844639	1	183
K7801Z-1.1/16	7314151844646	1	183
K7801Z-1.1/2	7314150137701	5	183
K7801Z-1.1/4	7314151844660	1	183
K7801Z-1.1/8	7314151844653	1	183
K7801Z-1.3/8	7314150137688	5	183



K7801Z-1.5/16	7314150137671	5	183
K7801Z-1.7/16	7314150137695	5	183
K7801Z-1/2	7314151822620	1	183
K7801Z-11/16	7314151844592	1	183
K7801Z-13/16	7314151844608	1	183
K7801Z-15/16	7314151844622	1	183
K7801Z-3/4	7314151822668	1	183
K7801Z-3/8	7314151822606	1	183
K7801Z-5/8	7314151844585	1	183
K7801Z-7/16	7314151844561	1	183
K7801Z-7/8	7314151844615	1	183
K7801Z-9/16	7314151822637	1	183
K7801Z/10	7314150165018	1	185
K7806M-10	7314151844677	1	182
K7806M-11	7314151844684	1	182
K7806M-12	7314151844691	1	182
K7806M-13	7314151805944	1	182
K7806M-14	7314151844707	1	182
K7806M-15	7314150330683	1	182
K7806M-16	7314151844714	1	182
K7806M-17	7314151805951	1	182
K7806M-18	7314151844721	1	182
K7806M-19	7314151805968	1	182
K7806M-21	7314151823597	1	182
K7806M-22	7314151805975	1	182
K7806M-23	7314151844738	1	182
K7806M-24	7314151805982	1	182
K7806M-27	7314151805999	1	182
K7806M-30	7314151844578	1	182
K7806M-32	7314150220304	1	182
K7806M-33	7314150554386	1	182
K7806M-34	7314150554393	1	182
K7806M-36	7314150220311	1	182
K7806M/S4	7314151813222	1	184
K7806Z-1	7314150137817	5	183
K7806Z-1.1/16	7314150137824	5	183
K7806Z-1.1/2	7314150137886	5	183
K7806Z-1.1/4	7314150137848	5	183
K7806Z-1.1/8	7314150137831	5	183
K7806Z-1.3/8	7314150137862	5	183
K7806Z-1.5/16	7314150137855	5	183
K7806Z-1.7/16	7314150137879	5	183
K7806Z-1/2	7314150137749	10	183
K7806Z-11/16	7314150137770	5	183
K7806Z-13/16	7314150137794	5	183
K7806Z-15/16	7314150137718	5	183
K7806Z-3/4	7314150137787	5	183
K7806Z-3/8	7314150137725	10	183
K7806Z-5/8	7314150137763	5	183
K7806Z-7/16	7314150137732	5	183
K7806Z-7/8	7314150137800	5	183
K7806Z-9/16	7314150137756	10	183
K7806Z/10	7314150165025	1	185
K8160D-1	7314151237400	1	184
K8160D-2	7314151237417	1	184
K8160D-3	7314151237424	1	184
K8164C	7314151237523	1	181
K8164F	7314151237554	1	187
K8167S	7314151237592	1	184
K8901M-17	7314151803155	1	186
K8901M-18	7314151844189	1	186
K8901M-19	7314151803162	1	186
K8901M-21	7314151803179	1	186
K8901M-22	7314151803186	1	186
K8901M-23	7314151803193	1	186
K8901M-24	7314151803209	1	186
K8901M-27	7314151803216	1	186
K8901M-28	7314151803223	1	186
K8901M-29	7314151803230	1	186
K8901M-30	7314151803247	1	186
K8901M-32	7314151803254	1	186
K8901M-33	7314151803261	1	186
K8901M-34	7314151803278	1	186
K8901M-36	7314151803285	1	186
K8901M-38	7314151803292	1	186
K8901M-41	7314151803308	1	186
K8901M-46	7314151803315	1	186
K8901M-50	7314151846398	1	186
K8901M-55	7314151846404	1	186
K8901M-60	7314151846411	1	186
K8901M/8	7314150165032	1	187
K8901Z-1	7314151844752	1	186
K8901Z-1.1/16	7314151844769	1	186
K8901Z-1.1/2	7314151844820	1	186
K8901Z-1.1/4	7314151844783	1	186
K8901Z-1.1/8	7314151844776	1	186
K8901Z-1.11/16	7314150130269	1	186
K8901Z-1.13/16	7314150130276	1	186
K8901Z-1.15/16	7314150130290	1	186
K8901Z-1.3/16	7314150130245	1	186
K8901Z-1.3/4	7314151844844	1	186
K8901Z-1.3/8	7314151844806	1	186
K8901Z-1.5/16	7314151844790	1	186
K8901Z-1.5/8	7314151844837	1	186
K8901Z-1.7/16	7314151844813	1	186
K8901Z-1.7/8	7314150130283	1	186

* Until stocks last



K8901Z-1.9/16	7314150130252	1	186
K8901Z-11/16	7314150130238	1	186
K8901Z-13/16	7314151844226	1	186
K8901Z-15/16	7314151844745	1	186
K8901Z-2	7314150130306	1	186
K8901Z-2.1/16	7314150130313	1	186
K8901Z-2.1/4	7314150130344	1	186
K8901Z-2.3/16	7314150130337	1	186
K8901Z-2.3/8	7314150130351	1	186
K8901Z-3/4	7314151844202	1	186
K8901Z-7/8	7314151844301	1	186
K8901Z/18	7314150436514	1	188
K8901Z/8	7314150165049	1	188
K8906M-17	7314151803056	1	186
K8906M-19	7314151803063	1	186
K8906M-21	7314151844851	1	186
K8906M-22	7314151803070	1	186
K8906M-24	7314151803087	1	186
K8906M-27	7314151803094	1	186
K8906M-30	7314151803117	1	186
K8906M-32	7314151803124	1	186
K8906M-33	7314151844868	1	186
K8906M-34	7314151844875	1	186
K8906M-36	7314151803148	1	186
K8906M-41	7314151845254	1	186
K8906M-42	7314150512607	1	186
K8906M-46	7314150220601	1	186
K8906M/8	7314150165056	1	187
K8906Z-1	7314150130436	1	186
K8906Z-1.1/16	7314150130443	1	186
K8906Z-1.1/2	7314150130511	1	186
K8906Z-1.1/4	7314150130474	1	186
K8906Z-1.1/8	7314150130450	1	186
K8906Z-1.3/4	7314150130559	1	186
K8906Z-1.3/8	7314150130498	1	186
K8906Z-1.5/16	7314150130481	1	186
K8906Z-1.5/8	7314150130535	1	186
K8906Z-1.7/16	7314150130504	1	186
K8906Z-13/16	7314150130405	1	186
K8906Z-15/16	7314150130429	1	186
K8906Z-2	7314150130580	1	186
K8906Z-3/4	7314150130399	1	186
K8906Z-7/8	7314150130412	1	186
K8906Z/8	7314150165063	1	188
K8909H-5	7314151619343	1	187
K8909ML-12	7314151232863	1	189
K8909ML-14	7314151232870	1	189
K8909ML-17	7314151232887	1	189
K8960F-2	7314151268138	1	187
K8960F-3	7314151268145	1	187
K8960F-4	7314150220625	1	187
K8964D	7314151268237	1	184
K8964G	7314151268268	1	189
K8967S	7314151268329	1	187
K9501M-22	7314151844882	1	188
K9501M-24	7314151802677	1	188
K9501M-27	7314151802684	1	188
K9501M-30	7314151802714	1	188
K9501M-32	7314151802721	1	188
K9501M-33	7314151802738	1	188
K9501M-34	7314151802745	1	188
K9501M-36	7314151802752	1	188
K9501M-38	7314151802769	1	188
K9501M-41	7314151802776	1	188
K9501M-42	7314151802783	1	188
K9501M-46	7314151802790	1	188
K9501M-50	7314151802806	1	188
K9501M-55	7314151802813	1	188
K9501M-60	7314151802820	1	188
K9501M-65	7314151802837	1	188
K9501M-70	7314151802844	1	188
K9501M-75	7314151802851	1	188
K9501M-80	7314151802868	1	188
K9501M-85	7314150352197	1	188
K9501Z-1	7314151844912	1	188
K9501Z-1.1/16	7314150130634	1	188
K9501Z-1.1/2	7314151844943	1	188
K9501Z-1.1/4	7314151844929	1	188
K9501Z-1.1/8	7314150130641	1	188
K9501Z-1.11/16	7314150130696	1	188
K9501Z-1.13/16	7314151844967	1	188
K9501Z-1.15/16	7314150130719	1	188
K9501Z-1.3/16	7314150130658	1	188
K9501Z-1.3/4	7314150130702	1	188
K9501Z-1.3/8	7314150130672	1	188
K9501Z-1.5/16	7314150130665	1	188
K9501Z-1.5/8	7314151844950	1	188
K9501Z-1.7/16	7314151844936	1	188
K9501Z-1.7/8	7314151844974	1	188
K9501Z-1.9/16	7314150130689	1	188
K9501Z-2	7314150130726	1	188
K9501Z-2.1/4	7314150130764	1	188
K9501Z-2.1/8	7314150130740	1	188
K9501Z-2.3/16	7314150130757	1	188
K9501Z-2.3/4	7314150130832	1	188
K9501Z-2.5/16	7314150130771	1	188



K9501Z-2.9/16



K9501Z-2.9/16	7314150130801	1	188
K9506M-22	7314151844998	1	188
K9506M-24	7314151802530	1	188
K9506M-27	7314151802547	1	188
K9506M-30	7314151802554	1	188
K9506M-32	7314151802561	1	188
K9506M-33	7314151802578	1	188
K9506M-34	7314151845018	1	188
K9506M-36	7314151802585	1	188
K9506M-38	7314151802592	1	188
K9506M-41	7314151802608	1	188
K9506M-46	7314151802615	1	188
K9506M-50	7314151802622	1	188
K9506M-55	7314151802639	1	188
K9506M-60	7314151802646	1	188
K9506Z-1	7314150131686	1	189
K9506Z-1.1/16	7314150131693	1	189
K9506Z-1.1/2	7314150131761	1	189
K9506Z-1.1/4	7314150131723	1	189
K9506Z-1.13/16	7314150131808	1	189
K9506Z-1.3/16	7314150131716	1	189
K9506Z-1.5/8	7314150131785	1	189
K9506Z-1.7/16	7314150131754	1	189
K9506Z-1.7/8	7314150131815	1	189
K9509H5	7314151619428	1	189
K9509ML-19	7314151618964	1	189
K9509ML-22	7314151619183	1	189
K9509ML-24	7314151619268	1	189
K9560G-0	7314150240012	1	189
K9560G-1	7314151285944	1	189
K9560G-2	7314151285951	1	189
K9560G-3	7314151285968	1	189
K9560G-4	7314150133970	1	189
K9560G-5	7314150133987	1	189
K9564F	7314151286026	1	187
K9567S	7314151286095	1	189
K9598H	7314150133956	1	191
K9801M-100	7314151845162	1	190
K9801M-105	7314151845179	1	190
K9801M-110	7314151845186	1	190
K9801M-115	7314151845193	1	190
K9801M-120	7314151845209	1	190
K9801M-125	7314150167159	1	190
K9801M-130	7314150167166	1	190
K9801M-135	7314150167173	1	190
K9801M-140	7314150167180	1	190
K9801M-145	7314150167197	1	190
K9801M-150	7314150167203	1	190
K9801M-155	7314150167210	1	190
K9801M-46	7314151845056	1	190
K9801M-50	7314151845063	1	190
K9801M-55	7314151845070	1	190
K9801M-60	7314151845087	1	190
K9801M-65	7314151845094	1	190
K9801M-70	7314151845100	1	190
K9801M-75	7314151845117	1	190
K9801M-80	7314151845124	1	190
K9801M-85	7314151845131	1	190
K9801M-90	7314151845148	1	190
K9801M-95	7314151845155	1	190
K9801Z-1.1/2	7314150131976	1	190
K9801Z-1.11/16	7314150132003	1	190
K9801Z-1.13/16	7314150132027	1	190
K9801Z-1.15/16	7314150132041	1	190
K9801Z-1.3/4	7314150132010	1	190
K9801Z-1.3/8	7314150131952	1	190
K9801Z-1.5/8	7314150131990	1	190
K9801Z-1.7/16	7314150131969	1	190
K9801Z-1.7/8	7314150132034	1	190
K9801Z-1.9/16	7314150131983	1	190
K9801Z-2	7314150132058	1	190
K9801Z-2.1/16	7314150132065	1	190
K9801Z-2.1/2	7314150132133	1	190
K9801Z-2.1/4	7314150132096	1	190
K9801Z-2.1/8	7314150132072	1	190
K9801Z-2.11/16	7314150132164	1	190
K9801Z-2.13/16	7314150132188	1	190
K9801Z-2.15/16	7314150132201	1	190
K9801Z-2.3/16	7314150132089	1	190
K9801Z-2.3/4	7314150132171	1	190
K9801Z-2.3/8	7314150132119	1	190
K9801Z-2.5/16	7314150132102	1	190
K9801Z-2.5/8	7314150132157	1	190
K9801Z-2.7/16	7314150132126	1	190
K9801Z-2.7/8	7314150132195	1	190
K9801Z-2.9/16	7314150132140	1	190
K9801Z-3	7314150132218	1	190
K9801Z-3.1/16	7314150132225	1	190
K9801Z-3.1/2	7314150132287	1	190
K9801Z-3.1/4	7314150132249	1	190
K9801Z-3.1/8	7314150132232	1	190
K9801Z-3.11/16	7314150132317	1	190
K9801Z-3.13/16	7314150132331	1	190
K9801Z-3.15/16	7314150132355	1	190
K9801Z-3.3/4	7314150132324	1	190
K9801Z-3.3/8	7314150132263	1	190



K9801Z-3.5/16	7314150132256	1	190
K9801Z-3.5/8	7314150132300	1	190
K9801Z-3.7/16	7314150132270	1	190
K9801Z-3.7/8	7314150132348	1	190
K9801Z-3.9/16	7314150132294	1	190
K9801Z-4	7314150132362	1	190
K9801Z-4.1/16	7314150132379	1	190
K9801Z-4.1/2	7314150132430	1	190
K9801Z-4.1/4	7314150132393	1	190
K9801Z-4.1/8	7314150132386	1	190
K9801Z-4.3/4	7314150132454	1	190
K9801Z-4.3/8	7314150132416	1	190
K9801Z-4.5/16	7314150132409	1	190
K9801Z-4.5/8	7314150132447	1	190
K9801Z-4.7/16	7314150132423	1	190
K9806M-100	7314150131105	1	190
K9806M-105	7314150131112	1	190
K9806M-110	7314150131129	1	190
K9806M-115	7314150131136	1	190
K9806M-120	7314150131143	1	190
K9806M-41	7314150130986	1	190
K9806M-46	7314150130993	1	190
K9806M-50	7314150131006	1	190
K9806M-55	7314150131013	1	190
K9806M-60	7314150131020	1	190
K9806M-65	7314150131037	1	190
K9806M-70	7314150131044	1	190
K9806M-75	7314150131051	1	190
K9806M-80	7314150131068	1	190
K9806M-85	7314150131075	1	190
K9806M-90	7314150131082	1	190
K9806M-95	7314150131099	1	190
K9806Z-1.1/2	7314150131174	1	190
K9806Z-1.11/16	7314150131198	1	190
K9806Z-1.3/8	7314150131150	1	190
K9806Z-1.5/8	7314150131181	1	190
K9806Z-1.7/16	7314150131167	1	190
K9806Z-2	7314150131204	1	190
K9806Z-2.1/16	7314150131211	1	190
K9806Z-2.1/2	7314150131273	1	190
K9806Z-2.1/4	7314150131235	1	190
K9806Z-2.11/16	7314150131303	1	190
K9806Z-2.13/16	7314150131327	1	190
K9806Z-2.15/16	7314150131341	1	190
K9806Z-2.3/16	7314150131228	1	190
K9806Z-2.3/4	7314150131310	1	190
K9806Z-2.3/8	7314150131259	1	190
K9806Z-2.5/16	7314150131242	1	190
K9806Z-2.5/8	7314150131297	1	190
K9806Z-2.7/16	7314150131266	1	190
K9806Z-2.7/8	7314150131334	1	190
K9806Z-2.9/16	7314150131280	1	190
K9806Z-3	7314150131358	1	190
K9806Z-3.1/16	7314150131365	1	190
K9806Z-3.1/2	7314150131433	1	190
K9806Z-3.1/4	7314150131396	1	190
K9806Z-3.1/8	7314150131372	1	190
K9806Z-3.11/16	7314150131464	1	190
K9806Z-3.13/16	7314150131488	1	190
K9806Z-3.15/16	7314150131501	1	190
K9806Z-3.3/16	7314150131389	1	190
K9806Z-3.3/4	7314150131471	1	190
K9806Z-3.3/8	7314150131419	1	190
K9806Z-3.5/16	7314150131402	1	190
K9806Z-3.5/8	7314150131457	1	190
K9806Z-3.7/16	7314150131426	1	190
K9806Z-3.7/8	7314150131495	1	190
K9806Z-3.9/16	7314150131440	1	190
K9806Z-4	7314150131518	1	190
K9806Z-4.1/16	7314150131525	1	190
K9806Z-4.1/2	7314150131570	1	190
K9806Z-4.1/4	7314150131549	1	190
K9806Z-4.1/8	7314150131532	1	190
K9806Z-4.3/4	7314150131594	1	190
K9806Z-4.3/8	7314150131563	1	190
K9806Z-4.5/16	7314150131556	1	190
K9806Z-4.5/8	7314150131587	1	190
K9860H-1	7314150133994	1	191
K9860H-2	7314150134007	1	191
K9860H-3	7314150134014	1	191
K9867S	7314150133932	1	191
K9895G	7314150133949	1	189
K9899H	7314150166763	1	191
K9998H	7314150133963	1	191
KB09-01	7314150196968	5	568
KB18-01	7314150196944	5	568
KBFU-01	7314150196913	5	567
KBGH-5P-DISPEN	7314150296729	20	568
KBGR-5P-DISPEN	7314150296774	20	568
KBGU-100P	7314150213405	1	567
KBGU-10P-DISPEN	7314150262984	20	567
KBGU-5P-DISPEN	7314150296705	20	567
KBRU-01	7314150196876	5	566
KBSK-01	7314150196999	5	569
KBSU-01	7314150197002	5	569
KBTU-01	7314150196982	5	569



KBWS-01	7314150225972	10	572
KCB753	7314150204915	1	178
KE18-01	7314150196937	5	566
KEFU-01	7314150196906	5	566
KERU-01	7314150196869	5	566
KEYRING	7314150500864	50	424
KG09-01	7314150196975	5	568
KG09-01-3P	7314150213962	10	568
KG18-01	7314150196951	5	568
KGAU-01	7314150223893	5	569
KGFU-01	7314150196920	5	567
KGRU-01	7314150196683	5	567
KGRU-02	7314150196680	5	567
KGSU-01	7314150197019	5	569
KHU-01	7314150268955	4	569
KM1/4-5/16-1P	7314150275953	50	179
KM653-1P	7314151840709	25	178
KM653-5P	7314150533565	25	178
KM653-QR-1P	7314151848507	50	177
KM653-QR-5P	7314150533589	25	177
KM653-SF	7314150204984	1	178
KM6701M-10	7314151844264	1	180
KM6701M-7	7314151844240	1	180
KM6701M-8	7314151844257	1	180
KM6750-1/4	7314150204595	1	177
KM6750-10-1P	7314150533626	20	177
KM6750-11-1P	7314150533640	20	177
KM6750-13-1P	7314150533664	20	177
KM6750-3/8	7314150204588	1	177
KM6750-6	7314150204601	1	177
KM6750-7-1P	7314150533725	20	177
KM6750-8-1P	7314150533749	20	177
KM753-QR-1P*	7314150204830	1	178
KMR150-1P	7314150204977	1	178
KMR653-1P	7314150204939	1	178
KMR653-5P	7314150533763	50	178
KMR753	7314150204946	1	178
KMR753-1P	7314150204953	1	178
KMT753-QR-1P	7314150391523	50	178
KMU-01	7314150197026	5	567
KR653	7314150204885	1	178
KR653-1P	7314150260263	25	178
KRSS-01	7314150214938	10	572
KS7401M-10*	7314150384495	1	181
KS7401M-11*	7314150384501	1	181
KS7401M-12*	7314150384518	1	181
KS7401M-13*	7314150384525	1	181
KS7401M-14*	7314150384532	1	181
KS7401M-15*	7314150384549	1	181
KS7401M-16*	7314150384556	1	181
KS7401M-17*	7314150384563	1	181
KS7401M-18*	7314150384570	1	181
KS7401M-19*	7314150384587	1	181
KS7401M-22*	7314150384594	1	181
KS7401M-9*	7314150384600	1	181
KSBG09-10DISPEN	7314150262991	20	568
KSBG18-10DISPEN	7314150263004	20	568
KSR753-1P*	7314150204908	1	517
KUBG09-5P*	7314150213450	20	568
KUBG18-5DISPEN	7314150296835	20	568
L1020I06	7314150501649	5	153
L1020M06	7311518133665	1	151
L1020M06X	7311518136369	1	151
L1020S06	7314150501670	5	152
L1225M06	7311518132774	1	151
L1225M06X	7311518136857	1	151
L1228I06	7314150501700	5	153
L1228S06	7314150501731	5	152
L1230AL06	7311518187668	1	152
L1230AL08	7311518181871	1	152
L1230M06	7311518182168	1	151
L1230M06X	7311518182175	1	151
L1630M06	7311518192914	1	151
L1630M06X	7311518187446	1	151
L1630M08	7311518182205	1	151
L1630M08X	7311518136833	1	151
LAP-KNIFE	7311518216443	10	621
LARGE	7314150437429	1	369
LS-6160-23	7311518041304	90	622
LS-COIN 19 CM	7311518031077	4	587
LS-COIN 26 CM	7311518333041	2	587
LS-COMBINESS	7311518041366	600	622
LS-MASSE-4	7311518012014	2	586
LS-MASSE-4FG	7311518275891	2	586
LS-MASSE-TR-4FG	7311518281106	2	587
LS-MERLIN-2.5	7311518012069	2	587
LS-MERLIN-2.5FG	7311518281113	2	587
LS-PIERRE CORINDON	7311518009977	1	622
LS-PIERRE-FAUX	7311518009038	90	622
LT-STEEL-30	7314150138012	5	527
LT-STEEL-50	7314150138029	5	527
LTB-10	7314150120048	6	527
LTB-20	7314150120062	6	527
LTB-30	7314150120086	6	527
LTG-10	7314150119981	6	527
LTG-20	7314150120000	6	527

* Until stocks last



LTG-30	7314150120024	6	527
LTS-100	7314150120147	5	527
LTS-100-E	7314150120154	5	527
LTS-30	7314150120109	5	527
LTS-30-E	7314150120116	5	527
LTS-50	7314150120123	5	527
LTS-50-E	7314150120130	5	527
LUB-2015	7311518335427	6	622
M0310M03	7311518036805	1	151
M0310M03X	7311518197063	1	151
M0613M03X	7311518196622	1	151
M0618M06	7311518036836	1	151
M0618M06X	7311518036850	1	151
M1022M06	7311518036881	1	151
M1022M06X	7311518036904	1	151
M1227M06	7311518036928	1	151
M1227M06X	7311518036959	1	151
M1227M08	7311518036980	1	151
M1630M06	7311518193010	1	151
M1630M06X	7311518187453	1	151
M1630M08	7311518037062	1	151
M1630M08X	7311518037086	1	151
M227L	7311518160883	4	565
M227R	7311518160869	4	565
M330	7311518160906	4	565
M526	7311518160982	4	565
M6376-SH	7311518199296	1	565
M676-SH*	7311518211875	1	565
M780	7314151826215	1	226
M781	7314153016218	5	226
MA225R	7311518161040	4	564
MA311	7314150181568	1	564
MA321	7314150181551	10	564
MA351	7314150181582	10	564
MA361	7314150181575	10	564
MA401	7314150167593	10	564
MA411	7314150167609	10	564
MA421	7314150167616	10	564
MA431	7314150181544	1	564
MA500-1A	7314150458882	1	637
MA500-2A	7314150458899	1	637
MA500-3A	7314150456925	1	637
MAM50M	7314150215300	1	121
MCP-2.5-810	7311518124052	2	586
MES-3.0-900	7311518123864	2	587
MES-3.5-900	7311518123871	2	587
MES-3.5-900FG	7311518281120	2	587
MK5	7314150224333	1	61
MK9	7314150224326	25	62
MONSTER	7314150437405	1	369
MR227L	7311518161002	4	565
MT-TS-3	7314150194995	12	526
MTB-3-16	7314150119066	6	526
MTB-3-16-M	7314150119073	6	526
MTB-3-16-M-E	7314150119141	6	526
MTB-5-25	7314150119080	6	526
MTB-5-25-C1	7314150119127	6	526
MTB-5-25-M	7314150119097	6	526
MTB-5-25-M-E	7314150119158	6	526
MTB-8-25	7314150125418	6	526
MTB-8-25-M	7314150127078	6	526
MTB-8-25-M-E	7314150127085	6	526
MTC-3-13	7314150321322	6	526
MTC-3-13-C1	7314150330843	6	526
MTC-5-16	7314150321339	6	526
MTC-5-16-C1	7314150330850	6	526
MTG-3-16	7314150118984	12	526
MTG-3-16-E	7314150119028	12	526
MTG-5-19	7314150118991	12	526
MTG-5-19-E	7314150119035	12	526
MTG-8-25	7314150330348	4	526
MTG-8-25-E	7314150390809	4	526
MTS-5-25	7314150119233	6	526
MTS-5-25-E	7314150119271	6	526
MTS-8-25	7314150119257	6	526
MTS-8-25-E	7314150119295	6	526
MTT051	7314150270521	6	572
MTT121	7314150213290	8	572
MTT151	7314150120703	6	572
MW-150	7314150125685	2	527
MW-250	7314150125678	2	527
N0306M03	7311518182212	1	151
N0306M03E	7311518182229	1	151
N0607M06	7311518182236	1	151
N1213M06	7311518134570	1	151
N1213M06X	7311518237172	1	151
N1613M06	7311518136000	1	151
N1613M06X	7311518204525	1	151
N1613M08	7311518182267	1	151
NP-12-COM	7311518264277	4	548
NP-12-TEN	7311518263959	10	552
NP-12-VEN	7311518264260	10	552
NP-16-U7/8-HP	7311518241773	4	549
NP-19-U7/8-HP	7311518241452	10	549
NP-22-F7/8-HP	7311518035204	10	550
NP-22-U7/8-HP	7311518034399	10	549



NS001-150



NS001-150	7314150316069	5	494
NS001-200	7314150316076	5	494
NS001-250	7314150316083	5	494
NS001-300	7314150316090	5	494
NS001-375	7314150325108	5	494
NS001-450	7314150325115	3	494
NS001-600	7314150325122	1	494
NS001-900	7314150325139	1	494
NS002-10	7314150284719	10	494
NS002-11	7314150292592	5	494
NS002-12	7314150292608	5	494
NS002-13	7314150284726	10	494
NS002-14	7314150284733	5	494
NS002-15	7314150292615	5	494
NS002-16	7314150292622	5	494
NS002-17	7314150284740	10	494
NS002-18	7314150292639	5	494
NS002-19	7314150284757	10	494
NS002-20	7314150292646	5	494
NS002-21	7314150292653	5	494
NS002-22	7314150292660	10	494
NS002-23	7314150292677	5	494
NS002-24	7314150292684	10	494
NS002-25	7314150292691	5	494
NS002-26	7314150292707	5	494
NS002-27	7314150284764	5	494
NS002-28	7314150292714	5	494
NS002-29	7314150292721	10	494
NS002-30	7314150292738	10	494
NS002-31	7314150292745	5	494
NS002-32	7314150284771	5	494
NS002-33	7314150292752	5	494
NS002-34	7314150292769	5	494
NS002-35	7314150292776	5	494
NS002-36	7314150284788	5	494
NS002-38	7314150292783	5	494
NS002-40	7314150292790	5	494
NS002-41	7314150292806	5	494
NS002-42	7314150292813	5	494
NS002-46	7314150292820	5	494
NS002-50	7314150292837	5	494
NS002-52	7314150292844	5	494
NS002-55	7314150292851	5	494
NS002-6	7314150292554	5	494
NS002-60	7314150292868	1	494
NS002-65	7314150292875	1	494
NS002-7	7314150292561	5	494
NS002-70*	7314150292882	1	494
NS002-75	7314150292899	1	494
NS002-8	7314150292578	5	494
NS002-80*	7314150292905	1	494
NS002-9	7314150292585	5	494
NS003-11*	7314150306602	1	494
NS003-12*	7314150306619	1	494
NS003-14*	7314150306626	1	494
NS003-16	7314150306633	1	494
NS003-18	7314150320356	1	494
NS003-20*	7314150320363	1	494
NS003-24*	7314150320370	1	494
NS003-28	7314150320387	1	494
NS003-30	7314150320394	1	494
NS003-8*	7314150320349	1	494
NS006-0607	7314150292912	1	495
NS006-0608	7314150292929	1	495
NS006-0708	7314150292936	1	495
NS006-0709	7314150292943	1	495
NS006-0809	7314150292967	1	495
NS006-0810	7314150292950	1	495
NS006-0910*	7314150292974	1	495
NS006-0911	7314150292981	1	495
NS006-1011	7314150292998	1	495
NS006-1012	7314150293001	1	495
NS006-1013	7314150293018	1	495
NS006-1014*	7314150293025	1	495
NS006-1113	7314150293032	1	495
NS006-1114	7314150293049	1	495
NS006-1213	7314150293056	1	495
NS006-1214	7314150293063	1	495
NS006-1315	7314150293070	1	495
NS006-1415	7314150293087	1	495
NS006-1416	7314150293094	1	495
NS006-1417	7314150293100	1	495
NS006-1617	7314150293117	1	495
NS006-1618	7314150293124	1	495
NS006-1719	7314150293131	1	495
NS006-1722*	7314150293148	1	495
NS006-1819	7314150293155	1	495
NS006-1820*	7314150293162	1	495
NS006-1920	7314150293179	1	495
NS006-1922	7314150293186	1	495
NS006-1924	7314150293193	1	495
NS006-2022	7314150293209	1	495
NS006-2122	7314150293216	1	495
NS006-2123	7314150293223	1	495
NS006-2223	7314150293230	1	495
NS006-2224	7314150293247	1	495



NS006-2227	7314150293254	1	495
NS006-2326	7314150293261	1	495
NS006-2425	7314150293278	1	495
NS006-2426	7314150293285	1	495
NS006-2427	7314150293292	1	495
NS006-2430	7314150293308	1	495
NS006-2528	7314150293315	1	495
NS006-2629*	7314150293322	1	495
NS006-2729	7314150293339	1	495
NS006-2730	7314150293346	1	495
NS006-2732	7314150293353	1	495
NS006-2830	7314150293360	1	495
NS006-3031	7314150293377	1	495
NS006-3032	7314150293384	1	495
NS006-3034*	7314150293391	1	495
NS006-3036	7314150293407	1	495
NS006-3234	7314150293414	1	495
NS006-3235	7314150293421	1	495
NS006-3236	7314150293438	1	495
NS006-3335	7314150293445	1	495
NS006-3436	7314150293452	1	495
NS006-3536	7314150293469	1	495
NS006-3638	7314150293476	1	495
NS006-3641	7314150293483	1	495
NS006-3642	7314150293490	1	495
NS006-4146	7314150293506	1	495
NS006-4650	7314150293513	1	495
NS006-5052*	7314150293520	1	495
NS006-5055	7314150293537	1	495
NS006-5060*	7314150293544	1	495
NS006-5062*	7314150293551	1	495
NS006-5560	7314150293568	1	495
NS006-6065	7314150293575	1	495
NS006-6570*	7314150293582	1	495
NS010-0607*	7314150293599	1	496
NS010-0709*	7314150293605	1	496
NS010-0809	7314150293612	1	496
NS010-0911*	7314150293629	1	496
NS010-1011	7314150293636	1	496
NS010-1012	7314150293643	1	496
NS010-1214	7314150293650	1	496
NS010-1315	7314150293667	1	496
NS010-1417	7314150293674	1	496
NS010-1618	7314150293681	1	496
NS010-1719	7314150293698	1	496
NS010-1722*	7314150293704	1	496
NS010-1819	7314150293711	1	496
NS010-1921	7314150293728	1	496
NS010-1922	7314150293735	1	496
NS010-2022	7314150293742	1	496
NS010-2123*	7314150293759	1	496
NS010-2224	7314150293766	1	496
NS010-2427	7314150293773	1	496
NS010-2528*	7314150293780	1	496
NS010-2628	7314150293797	1	496
NS010-2730	7314150293803	1	496
NS010-2732	7314150293810	1	496
NS010-3032	7314150293827	1	496
NS010-3036	7314150293834	1	496
NS010-3236	7314150293841	1	496
NS010-3641	7314150293858	1	496
NS010-4146*	7314150293865	1	496
NS010-4650*	7314150293872	1	496
NS011-0607	7314150317271	1	496
NS011-0809	7314150317288	1	496
NS011-1011	7314150317295	1	496
NS011-1213	7314150317301	1	496
NS011-1415	7314150317318	1	496
NS011-1617	7314150317325	1	496
NS011-1819	7314150317332	1	496
NS011-2022	7314150317349	1	496
NS011-2123	7314150317356	1	496
NS011-2426	7314150317363	1	496
NS011-2528	7314150317370	1	496
NS011-2729	7314150317387	1	496
NS011-3032	7314150317394	1	496
NS041-12-50*	7314150502547	1	512
NS041-16-100*	7314150502561	1	512
NS041-16-200	7314150502332	1	512
NS041-16-260	7314150502585	1	512
NS041-24-670*	7314150502608	1	512
NS041-32-900*	7314150502622	1	512
NS041-8-25	7314150502646	1	512
NS100-100	7314150294305	1	497
NS100-105	7314150294312	1	497
NS100-110	7314150294329	1	497
NS100-115	7314150294336	1	497
NS100-120	7314150294343	1	497
NS100-17	7314150293889	1	496
NS100-19	7314150293896	1	496
NS100-22	7314150293902	1	496
NS100-24	7314150293919	1	496
NS100-25*	7314150293926	1	496
NS100-27	7314150293933	1	496
NS100-28	7314150293940	1	496
NS100-29*	7314150293957	1	496

NS100-30	7314150293964	1	496
NS100-32	7314150293971	1	496
NS100-33*	7314150293988	1	496
NS100-34	7314150293995	1	496
NS100-35*	7314150294008	1	496
NS100-36	7314150294015	1	496
NS100-37*	7314150294022	1	497
NS100-38	7314150294039	1	497
NS100-41	7314150294046	1	497
NS100-42	7314150294053	1	497
NS100-45*	7314150294060	1	497
NS100-46	7314150294077	1	497
NS100-47*	7314150294084	1	497
NS100-50	7314150294091	1	497
NS100-52	7314150294107	1	497
NS100-54	7314150294114	1	497
NS100-55	7314150294121	1	497
NS100-56	7314150294138	1	497
NS100-58	7314150294145	1	497
NS100-60	7314150294152	1	497
NS100-63*	7314150294169	1	497
NS100-65	7314150294176	1	497
NS100-67*	7314150294183	1	497
NS100-70	7314150294190	1	497
NS100-71*	7314150294206	1	497
NS100-75	7314150294213	1	497
NS100-77*	7314150294220	1	497
NS100-80	7314150294237	1	497
NS100-82	7314150294244	1	497
NS100-85	7314150294251	1	497
NS100-88*	7314150294268	1	497
NS100-90	7314150294275	1	497
NS100-94*	7314150294282	1	497
NS100-95	7314150294299	1	497
NS104-100	7314150294947	1	497
NS104-105	7314150294954	1	497
NS104-110	7314150294961	1	497
NS104-115	7314150294978	1	497
NS104-120	7314150294985	1	497
NS104-17	7314150294350	1	497
NS104-19	7314150294367	1	497
NS104-20*	7314150294374	1	497
NS104-22	7314150294381	1	497
NS104-24	7314150284795	1	497
NS104-25*	7314150294398	1	497
NS104-26	7314150294404	1	497
NS104-27	7314150284801	1	497
NS104-28	7314150294411	1	497
NS104-29	7314150294428	1	497
NS104-30	7314150284818	1	497
NS104-31	7314150294435	1	497
NS104-32	7314150284825	1	497
NS104-33	7314150294442	1	497
NS104-34	7314150294459	1	497
NS104-35	7314150294466	1	497
NS104-36	7314150284832	1	497
NS104-37	7314150294473	1	497
NS104-38	7314150294480	1	497
NS104-39	7314150294497	1	497
NS104-40	7314150294503	1	497
NS104-41	7314150284849	1	497
NS104-42	7314150294510	1	497
NS104-43*	7314150294527	1	497
NS104-44*	7314150294534	1	497
NS104-45*	7314150294541	1	497
NS104-46	7314150284856	1	497
NS104-47	7314150294558	1	497
NS104-48	7314150294565	1	497
NS104-49	7314150294572	1	497
NS104-50	7314150284863	1	497
NS104-51	7314150294589	1	497
NS104-52	7314150294596	1	497
NS104-53*	7314150294602	1	497
NS104-54	7314150294619	1	497
NS104-55	7314150284870	1	497
NS104-56	7314150294626	1	497
NS104-57	7314150294633	1	497
NS104-58*	7314150294640	1	497
NS104-59*	7314150294657	1	497
NS104-60	7314150284887	1	497
NS104-61*	7314150294664	1	497
NS104-62*	7314150294671	1	497
NS104-63	7314150294688	1	497
NS104-64*	7314150294695	1	497
NS104-65	7314150294701	1	497
NS104-66*	7314150294718	1	497
NS104-67*	7314150294725	1	497
NS104-68*	7314150294732	1	497
NS104-69*	7314150294749	1	497
NS104-70	7314150284894	1	497
NS104-71*	7314150294756	1	497
NS104-72*	7314150294763	1	497
NS104-73*	7314150294770	1	497
NS104-74*	7314150294787	1	497
NS104-75	7314150284900	1	497
NS104-76*	7314150294794	1	497

* Until stocks last

NS104-77*	7314150294800	1	497
NS104-78*	7314150294817	1	497
NS104-79*	7314150294824	1	497
NS104-80	7314150284917	1	497
NS104-81*	7314150294831	1	497
NS104-82*	7314150294848	1	497
NS104-83*	7314150294855	1	497
NS104-84*	7314150294862	1	497
NS104-85	7314150284924	1	497
NS104-86*	7314150294879	1	497
NS104-87*	7314150294886	1	497
NS104-88*	7314150294893	1	497
NS104-89*	7314150294909	1	497
NS104-90	7314150284931	1	497
NS104-92*	7314150294916	1	497
NS104-94*	7314150294923	1	497
NS104-95	7314150284948	1	497
NS104-98*	7314150294930	1	497
NS106-100*	7314150295418	1	498
NS106-104*	7314150295425	1	498
NS106-108*	7314150295432	1	498
NS106-112*	7314150295449	1	498
NS106-114*	7314150295456	1	498
NS106-116*	7314150295463	1	498
NS106-120*	7314150295470	1	498
NS106-124*	7314150295487	1	498
NS106-126*	7314150295494	1	498
NS106-128*	7314150295502	1	498
NS106-132*	7314150295517	1	498
NS106-136*	7314150295524	1	498
NS106-138*	7314150295531	1	498
NS106-144*	7314150295548	1	498
NS106-146*	7314150295555	1	498
NS106-150*	7314150295562	1	498
NS106-156*	7314150295579	1	498
NS106-158*	7314150295586	1	498
NS106-20	7314150294992	1	498
NS106-22*	7314150295005	1	498
NS106-24*	7314150295012	1	498
NS106-25*	7314150295029	1	498
NS106-26	7314150295036	1	498
NS106-28	7314150295043	1	498
NS106-30	7314150295050	1	498
NS106-32*	7314150295067	1	498
NS106-34	7314150295074	1	498
NS106-36	7314150295081	1	498
NS106-38*	7314150295098	1	498
NS106-40	7314150295104	1	498
NS106-42	7314150295111	1	498
NS106-44*	7314150295128	1	498
NS106-45*	7314150295135	1	498
NS106-46	7314150295142	1	498
NS106-48	7314150295159	1	498
NS106-50*	7314150295166	1	498
NS106-52	7314150295173	1	498
NS106-54*	7314150295180	1	498
NS106-56*	7314150295197	1	498
NS106-58	7314150295203	1	498
NS106-60	7314150295210	1	498
NS106-62*	7314150295227	1	498
NS106-64	7314150295234	1	498
NS106-66*	7314150295241	1	498
NS106-68*	7314150295258	1	498
NS106-70*	7314150295265	1	498
NS106-71*	7314150295272	1	498
NS106-72	7314150295289	1	498
NS106-74*	7314150295296	1	498
NS106-76*	7314150295302	1	498
NS106-78*	7314150295319	1	498
NS106-80*	7314150295326	1	498
NS106-82*	7314150295333	1	498
NS106-84*	7314150295340	1	498
NS106-88*	7314150295357	1	498
NS106-90*	7314150295364	1	498
NS106-92*	7314150295371	1	498
NS106-94*	7314150295388	1	498
NS106-96	7314150295395	1	498
NS106-98*	7314150295401	1	498
NS200-1200*	7314150295661	1	499
NS200-200	7314150295693	1	499
NS200-250	7314150295609	1	499
NS200-300	7314150295616	1	499
NS200-350	7314150295623	1	499
NS200-450	7314150295630	1	499
NS200-600	7314150295647	1	499
NS200-900	7314150295654	1	499
NS202-350	7314150299690	1	499
NS203-200	7314150359509	1	499
NS203-215	7314150359516	1	499
NS203-290	7314150359523	1	499
NS203-400	7314150359530	1	499
NS203-490	7314150359547	1	499
NS203-800	7314150359554	1	499
NS204-30	7314150295685	1	499
NS204-32	7314150295692	1	499
NS204-35	7314150295708	1	499





NS204-40	7314150295715	1	499
NS204-45	7314150295722	1	499
NS204-48	7314150295739	1	499
NS204-50	7314150295746	1	499
NS204-55*	7314150295753	1	499
NS204-60	7314150295760	1	499
NS204-65	7314150295777	1	499
NS204-70	7314150295784	1	499
NS204-75*	7314150295791	1	499
NS204-80	7314150295807	1	499
NS204-85*	7314150295814	1	499
NS204-90	7314150295821	1	499
NS220-06	7314150347216	1	500
NS220-07	7314150347223	1	500
NS220-08	7314150347230	1	500
NS220-09	7314150347247	1	500
NS220-10	7314150347254	1	500
NS220-11	7314150347261	1	500
NS220-12	7314150347278	1	500
NS220-13	7314150347285	1	500
NS220-14	7314150347292	1	500
NS220-15	7314150347308	1	500
NS220-16	7314150347315	1	500
NS220-17	7314150347322	1	500
NS220-18	7314150347339	1	500
NS220-19	7314150347346	1	500
NS220-20	7314150347353	1	500
NS220-21	7314150347360	1	500
NS220-22	7314150347377	1	500
NS220-23	7314150347384	1	500
NS220-24	7314150347391	1	500
NS220-25	7314150347407	1	500
NS220-26	7314150347414	1	500
NS220-27	7314150347421	1	500
NS220-28	7314150347438	1	500
NS220-29	7314150347445	1	500
NS220-30	7314150347452	1	500
NS220-32	7314150347469	1	500
NS220-34*	7314150347476	1	500
NS220-36	7314150347483	1	500
NS220-41	7314150347490	1	500
NS224-17	7314150355525	1	500
NS224-18*	7314150355532	1	500
NS224-19	7314150355549	1	500
NS224-21*	7314150355556	1	500
NS224-22	7314150355563	1	500
NS224-23	7314150355570	1	500
NS224-24	7314150355587	1	500
NS224-26*	7314150355594	1	500
NS224-27	7314150355617	1	500
NS224-28*	7314150355624	1	500
NS224-29	7314150355631	1	500
NS224-30	7314150355648	1	500
NS224-32	7314150355655	1	500
NS224-34	7314150355662	1	500
NS224-36	7314150355679	1	500
NS224-38	7314150355686	1	500
NS224-41	7314150355693	1	500
NS224-46	7314150355709	1	500
NS224-50	7314150355716	1	500
NS228-22	7314150355914	1	501
NS228-24	7314150355921	1	501
NS228-26*	7314150355938	1	501
NS228-27*	7314150355945	1	501
NS228-28*	7314150355952	1	501
NS228-29*	7314150355969	1	501
NS228-30*	7314150355976	1	501
NS228-31*	7314150355983	1	501
NS228-32	7314150355990	1	501
NS228-34*	7314150356003	1	501
NS228-36	7314150356010	1	501
NS228-38*	7314150356027	1	501
NS228-41	7314150356034	1	501
NS228-46	7314150356041	1	501
NS228-50	7314150356058	1	501
NS228-55	7314150356065	1	501
NS228-60	7314150356072	1	501
NS228-65	7314150356089	1	501
NS228-70	7314150356096	1	501
NS228-75*	7314150356102	1	501
NS228-80*	7314150356119	1	501
NS232-16-24	7314150356331	1	501
NS232-24-16	7314150356355	1	501
NS232-24-32*	7314150356348	1	501
NS232-32-24	7314150356362	1	501
NS234-16-100	7314150356416	1	501
NS234-16-200	7314150356423	1	501
NS234-16-250	7314150356430	1	501
NS234-24-200	7314150356447	1	501
NS234-32-250	7314150356454	1	501
NS236-16	7314150356522	1	501
NS236-24*	7314150356539	1	501
NS236-32*	7314150356515	1	501
NS238-16-250	7314150356577	1	502
NS238-24-250	7314150356584	1	502
NS238-32-300*	7314150356591	1	502



NS240-16-230	7314150356737	1	502
NS242-16	7314150356638	1	502
NS242-24	7314150356645	1	502
NS242-32*	7314150356652	1	502
NS243-16-400	7314150356690	1	502
NS247-26*	7314150356751	1	503
NS248-16-52*	7314150356713	1	503
NS300-10-200	7314150317783	1	503
NS300-10-300	7314150316205	1	503
NS300-11-250	7314150317790	1	503
NS300-11-300	7314150317806	1	503
NS300-11-350	7314150316212	1	503
NS300-12-400	7314150325153	1	503
NS300-13-450	7314150325160	1	503
NS300-3-50	7314150317677	1	503
NS300-3-75	7314150317684	1	503
NS300-4-75	7314150317691	1	503
NS300-4.5-100	7314150316175	1	503
NS300-4.5-50	7314150317707	1	503
NS300-5-100	7314150317721	1	503
NS300-5-75	7314150317714	1	503
NS300-6-100	7314150316182	1	503
NS300-6-125	7314150317738	1	503
NS300-6-150	7314150317745	1	503
NS300-7-150	7314150317752	1	503
NS300-8-150	7314150316199	1	503
NS300-8-200	7314150317769	1	503
NS300-9-250	7314150317776	1	503
NS301-10-200	7314150317882	1	503
NS301-10-300	7314150317899	1	503
NS301-3-50	7314150317813	1	503
NS301-4-100	7314150317820	1	503
NS301-4-150	7314150317837	1	503
NS301-5-100	7314150317844	1	503
NS301-5-200	7314150317851	1	503
NS301-6-100	7314150317868	1	503
NS301-8-150	7314150317875	1	503
NS302-0-50	7314150316229	1	504
NS302-1-100	7314150316236	1	504
NS302-2-125	7314150316243	1	504
NS302-3-150	7314150316250	1	504
NS302-4-300	7314150316267	1	504
NS304-0-50	7314150316274	1	504
NS304-1-100	7314150316281	1	504
NS304-2-125	7314150316298	1	504
NS304-3-150	7314150316304	1	504
NS304-4-300	7314150316311	1	504
NS320-10	7314150318162	1	504
NS320-2	7314150318087	1	504
NS320-3	7314150318094	1	504
NS320-4	7314150318100	1	504
NS320-5	7314150318117	1	504
NS320-6	7314150318124	1	504
NS320-7	7314150318131	1	504
NS320-8	7314150318148	1	504
NS320-9	7314150318155	1	504
NS400-160	7314150316106	1	504
NS400-180	7314150316113	1	504
NS400-200	7314150316120	1	504
NS402-160	7314150316137	1	505
NS402-200	7314150325177	1	505
NS403-160	7314150318209	1	505
NS403-180	7314150318193	1	505
NS404-160	7314150318216	1	505
NS405-160	7314150318247	1	505
NS406-160	7314150316144	1	505
NS406-180	7314150318261	1	505
NS406-200	7314150316151	1	505
NS407-160	7314150318278	1	505
NS408-250	7314150316168	1	506
NS408-300	7314150318292	1	506
NS411-200	7314150318322	1	506
NS412-200	7314150318339	1	506
NS413-180	7314150318384	1	506
NS413-200	7314150318377	1	506
NS500-1000-FB	7314150296019	1	507
NS500-1500-FB	7314150296026	1	507
NS500-2000	7314150291847	1	506
NS500-2000-FB	7314150284955	1	507
NS500-2500	7314150291854	1	506
NS500-2500-FB	7314150284962	1	507
NS500-3000	7314150291861	1	506
NS500-3000-FB	7314150284979	1	507
NS500-3500-FB	7314150284986	1	507
NS500-4000	7314150291878	1	506
NS502-1000-FB	7314150284993	1	507
NS502-10000-FB	7314150285068	1	507
NS502-12000-FB*	7314150318407	1	507
NS502-1500-FB	7314150318438	1	507
NS502-2000-FB	7314150285006	1	507
NS502-2500-FB	7314150285013	1	507
NS502-3000-FB	7314150285020	1	507
NS502-450-FB	7314150296033	1	507
NS502-4500-FB	7314150285037	1	507
NS502-5000-FB	7314150285044	1	507
NS502-6800-FB	7314150318445	1	507



NS502-8000-FB	7314150285051	1	507
NS504-100-FB	7314150296040	1	507
NS504-1000-FB	7314150285099	1	507
NS504-1500-FB	7314150285105	1	507
NS504-200-FB	7314150296057	1	507
NS504-2000-FB	7314150285112	1	507
NS504-300-FB	7314150296064	1	507
NS504-500-FB	7314150285075	1	507
NS504-800-FB	7314150285082	1	507
NS506-300	7314150285129	1	507
NS506-300-FB	7314150318469	1	508
NS506-450	7314150285136	1	507
NS506-450-FB	7314150318476	1	508
NS506-700	7314150296071	1	507
NS506-700-FB	7314150285143	1	508
NS506-900	7314150296088	1	507
NS506-900-FB	7314150285150	1	508
NS508-500-FB	7314150318544	1	508
NS508-700-FB	7314150318537	1	508
NS512-200-FB	7314150318568	1	508
NS512-400-FB	7314150318575	1	508
NS512-600-FB	7314150318582	1	508
NS512-900-FB	7314150318599	1	508
NS600-100-50	7314150296101	1	508
NS600-135-50	7314150296118	1	508
NS600-150-25	7314150296125	1	508
NS600-150-30	7314150301676	1	508
NS600-150-40	7314150296132	1	508
NS600-150-50	7314150296149	1	508
NS600-180-13	7314150296156	1	508
NS600-180-32	7314150285167	1	508
NS600-180-50	7314150285174	1	508
NS600-200-20	7314150296163	1	508
NS600-200-30	7314150296170	1	508
NS600-200-40	7314150296187	1	508
NS600-200-50	7314150301782	1	508
NS600-230-40	7314150296194	1	508
NS600-250-40	7314150296200	1	508
NS600-300-50	7314150296217	1	508
NS600-80-13	7314150296095	1	508
NS602-460	7314150285181	1	509
NS602-600	7314150285198	1	509
NS602-760	7314150296224	1	509
NS602-900	7314150296231	1	509
NS604-150	7314150296248	1	509
NS604-200	7314150285204	1	509
NS604-300	7314150285211	1	509
NS606-150	7314150285228	1	509
NS606-200	7314150285235	1	509
NS606-250	7314150285242	1	509
NS606-300	7314150285259	1	509
NS606-400	7314150285266	1	509
NS608-100	7314150285273	1	509
NS700-300	7314150325184	1	509
NS702-200	7314150325191	1	510
NS704-225	7314150325207	1	510
NS706-50	7314150325214	1	510
NS706-80	7314150325221	1	510
NS708-360	7314150325238	1	510
NS710-450	7314150325245	1	511
NS800-1100	7314150296323	1	511
NS800-1700	7314150285280	1	511
NS800-2000	7314150296330	1	511
NS802-290	7314150285297	1	511
NS804-290	7314150296347	1	511
NS810-100*	7314150318728	1	511
NS810-150*	7314150318711	1	511
NS810-200*	7314150318704	1	511
NS810-350*	7314150318698	1	511
NSB001-150	7314150292509	5	494
NSB001-200	7314150284689	5	494
NSB001-250	7314150284696	5	494
NSB001-300	7314150284702	5	494
NSB001-375	7314150292516	5	494
NSB001-450	7314150292523	3	494
NSB001-600	7314150292530	3	494
NSB001-900	7314150292547	1	494
NSB002-10	7314150316366	5	494
NSB002-11	7314150316373	5	494
NSB002-12	7314150316380	5	494
NSB002-13	7314150316397	5	494
NSB002-14	7314150316403	5	494
NSB002-15	7314150316410	5	494
NSB002-16	7314150316427	5	494
NSB002-17	7314150316434	5	494
NSB002-18	7314150316441	5	494
NSB002-19	7314150316458	5	494
NSB002-20	7314150316465	5	494
NSB002-21	7314150316472	5	494
NSB002-22	7314150316489	5	494
NSB002-23	7314150316496	5	494
NSB002-24	7314150316502	5	494
NSB002-25	7314150316519	5	494
NSB002-26	7314150316526	5	494
NSB002-27	7314150316533	5	494
NSB002-28	7314150316540	5	494

* Until stocks last



NSB002-29	7314150316557	5	494
NSB002-30	7314150316564	5	494
NSB002-31	7314150321728	1	494
NSB002-32	7314150316571	10	494
NSB002-33	7314150321735	1	494
NSB002-34	7314150321742	1	494
NSB002-35	7314150321759	1	494
NSB002-36	7314150321766	5	494
NSB002-38	7314150321773	1	494
NSB002-40	7314150321780	1	494
NSB002-41	7314150321797	5	494
NSB002-42	7314150321803	1	494
NSB002-46	7314150321810	1	494
NSB002-50	7314150321827	1	494
NSB002-52*	7314150321834	1	494
NSB002-55*	7314150321841	1	494
NSB002-6	7314150316328	5	494
NSB002-60*	7314150321858	1	494
NSB002-65*	7314150321865	1	494
NSB002-7	7314150316335	5	494
NSB002-70*	7314150321872	1	494
NSB002-75*	7314150321889	1	494
NSB002-8	7314150316342	5	494
NSB002-80*	7314150321896	1	494
NSB002-9	7314150316359	5	494
NSB003-10	7314150342709	1	494
NSB003-11	7314150342716	1	494
NSB003-12	7314150342723	5	494
NSB003-13*	7314150342730	1	494
NSB003-14	7314150342747	1	494
NSB003-16	7314150342754	5	495
NSB003-18	7314150342761	1	495
NSB003-19*	7314150342778	1	495
NSB003-20	7314150342785	1	495
NSB003-22	7314150342792	5	495
NSB003-24	7314150342808	5	495
NSB003-25*	7314150342815	1	495
NSB003-26*	7314150342822	1	495
NSB003-28*	7314150342839	5	495
NSB003-30	7314150342846	1	495
NSB003-31*	7314150342853	1	495
NSB003-32	7314150342860	1	495
NSB003-34	7314150342877	1	495
NSB003-36	7314150342884	1	495
NSB003-38*	7314150342891	1	495
NSB003-40	7314150342907	1	495
NSB003-42	7314150342914	1	495
NSB003-44*	7314150342921	5	495
NSB003-46*	7314150342938	1	495
NSB003-48*	7314150342945	1	495
NSB003-50*	7314150342952	1	495
NSB003-52	7314150342969	1	495
NSB003-54*	7314150342976	1	495
NSB003-56*	7314150342983	1	495
NSB003-58*	7314150342990	1	495
NSB003-60*	7314150343010	1	495
NSB003-62*	7314150343027	1	495
NSB003-64*	7314150343034	5	495
NSB003-68*	7314150343041	1	495
NSB003-72*	7314150343058	1	495
NSB003-8*	7314150342693	1	494
NSB003-80*	7314150343065	1	495
NSB003-84	7314150343072	1	495
NSB003-88	7314150343089	1	495
NSB006-0607	7314150316588	1	495
NSB006-0608*	7314150321926	1	495
NSB006-0708	7314150321933	1	495
NSB006-0709*	7314150321940	1	495
NSB006-0809	7314150316595	1	495
NSB006-0810	7314150321957	1	495
NSB006-0910	7314150321964	1	495
NSB006-0911	7314150321971	1	495
NSB006-1011	7314150316601	1	495
NSB006-1012	7314150322015	1	495
NSB006-1013	7314150322022	1	495
NSB006-1014	7314150322039	1	495
NSB006-1113	7314150322046	1	495
NSB006-1114*	7314150322053	1	495
NSB006-1213	7314150316618	1	495
NSB006-1214	7314150322060	1	495
NSB006-1315	7314150322077	1	495
NSB006-1415	7314150316625	1	495
NSB006-1416	7314150322084	1	495
NSB006-1417	7314150322091	1	495
NSB006-1617	7314150316632	1	495
NSB006-1618	7314150322107	1	495
NSB006-1719	7314150322114	1	495
NSB006-1722*	7314150322121	1	495
NSB006-1819	7314150316649	1	495
NSB006-1820*	7314150322138	1	495
NSB006-1920	7314150322145	1	495
NSB006-1922	7314150322152	1	495
NSB006-1924*	7314150322169	1	495
NSB006-2022	7314150316656	1	495
NSB006-2122	7314150322176	1	495
NSB006-2123	7314150316663	1	495





NSB006-2223	7314150322183	1	495
NSB006-2224	7314150322190	1	495
NSB006-2227*	7314150322206	1	495
NSB006-2326	7314150322213	1	495
NSB006-2425	7314150322220	1	495
NSB006-2426	7314150316670	1	495
NSB006-2427	7314150322237	1	495
NSB006-2430	7314150322244	1	495
NSB006-2528	7314150316687	1	495
NSB006-2629*	7314150322251	1	495
NSB006-2729	7314150316694	1	495
NSB006-2730	7314150322336	1	495
NSB006-2732	7314150322343	1	495
NSB006-2830	7314150322350	1	495
NSB006-3031	7314150322367	1	495
NSB006-3032	7314150316700	1	495
NSB006-3034*	7314150322374	1	495
NSB006-3036	7314150322381	1	495
NSB006-3234	7314150322398	1	495
NSB006-3235	7314150322404	1	495
NSB006-3236	7314150322411	1	495
NSB006-3335*	7314150322428	1	495
NSB006-3436	7314150322435	1	495
NSB006-3536*	7314150322442	1	495
NSB006-3638	7314150322459	1	495
NSB006-3641	7314150322466	1	495
NSB006-3642*	7314150322473	1	495
NSB006-4146	7314150322480	1	495
NSB006-4650	7314150322497	1	495
NSB006-5052*	7314150322503	1	495
NSB006-5055*	7314150322510	1	495
NSB006-5060*	7314150322527	1	495
NSB006-5062*	7314150322534	1	495
NSB006-5560*	7314150322558	1	495
NSB006-6065*	7314150322565	1	495
NSB006-6570*	7314150322572	1	495
NSB010-0607	7314150322589	1	496
NSB010-0709*	7314150322596	1	496
NSB010-0809	7314150322602	1	496
NSB010-0911*	7314150322619	1	496
NSB010-1011	7314150322626	1	496
NSB010-1012*	7314150322633	1	496
NSB010-1214	7314150322640	1	496
NSB010-1315*	7314150322657	1	496
NSB010-1417*	7314150322664	1	496
NSB010-1618	7314150322671	1	496
NSB010-1719	7314150322688	1	496
NSB010-1722*	7314150322695	1	496
NSB010-1819*	7314150322718	1	496
NSB010-1921*	7314150322725	1	496
NSB010-1922	7314150322732	1	496
NSB010-2022	7314150322749	1	496
NSB010-2123*	7314150322756	1	496
NSB010-2224*	7314150322763	1	496
NSB010-2427	7314150322770	1	496
NSB010-2528*	7314150322787	1	496
NSB010-2628*	7314150322794	1	496
NSB010-2730*	7314150322800	1	496
NSB010-2732*	7314150322817	1	496
NSB010-3032	7314150322824	1	496
NSB010-3036*	7314150322831	1	496
NSB010-3236*	7314150322848	1	496
NSB010-3641	7314150322855	1	496
NSB010-4146	7314150322862	1	496
NSB010-4650*	7314150322879	1	496
NSB011-0607	7314150317400	1	496
NSB011-0809	7314150317417	1	496
NSB011-1011	7314150317424	1	496
NSB011-1213	7314150317431	1	496
NSB011-1415	7314150317448	1	496
NSB011-1617	7314150317455	1	496
NSB011-1819	7314150317462	1	496
NSB011-2022	7314150317479	1	496
NSB011-2123	7314150317486	1	496
NSB011-2426	7314150317493	1	496
NSB011-2528*	7314150317509	1	496
NSB011-2729*	7314150317516	1	496
NSB011-3032	7314150317523	1	496
NSB041-12-50	7314150502660	1	512
NSB041-16-100*	7314150502684	1	512
NSB041-16-200	7314150502318	1	512
NSB041-16-260	7314150502707	1	512
NSB041-24-670*	7314150502721	1	512
NSB041-32-900*	7314150502745	1	512
NSB041-8-25	7314150502769	1	512
NSB100-100*	7314150323302	1	497
NSB100-105*	7314150323319	1	497
NSB100-110*	7314150323326	1	497
NSB100-115*	7314150323333	1	497



NSB100-120*	7314150323340	1	497
NSB100-17*	7314150322886	1	497
NSB100-19*	7314150322893	1	497
NSB100-22	7314150322909	1	497
NSB100-24	7314150322916	1	497
NSB100-25	7314150322923	1	497
NSB100-27	7314150322930	1	497
NSB100-28	7314150322947	1	497
NSB100-29*	7314150322954	1	497
NSB100-30	7314150322961	1	497
NSB100-32	7314150322978	1	497
NSB100-33	7314150322985	1	497
NSB100-34*	7314150322992	1	497
NSB100-35	7314150323005	1	497
NSB100-36	7314150323012	1	497
NSB100-37*	7314150323029	1	497
NSB100-38	7314150323036	1	497
NSB100-41	7314150323043	1	497
NSB100-42	7314150323050	1	497
NSB100-45	7314150323067	1	497
NSB100-46	7314150323074	1	497
NSB100-47*	7314150323081	1	497
NSB100-50	7314150323098	1	497
NSB100-52	7314150323104	1	497
NSB100-54*	7314150323111	1	497
NSB100-55	7314150323128	1	497
NSB100-56*	7314150323135	1	497
NSB100-58*	7314150323142	1	497
NSB100-60*	7314150323159	1	497
NSB100-63	7314150323166	1	497
NSB100-65	7314150323173	1	497
NSB100-67*	7314150323180	1	497
NSB100-70*	7314150323197	1	497
NSB100-71*	7314150323203	1	497
NSB100-75*	7314150323210	1	497
NSB100-77	7314150323227	1	497
NSB100-80	7314150323234	1	497
NSB100-82	7314150323241	1	497
NSB100-85*	7314150323258	1	497
NSB100-88*	7314150323265	1	497
NSB100-90	7314150323272	1	497
NSB100-94*	7314150323289	1	497
NSB100-95*	7314150323296	1	497
NSB104-100*	7314150316885	1	498
NSB104-105*	7314150316892	1	498
NSB104-110*	7314150316908	1	498
NSB104-115*	7314150323937	1	498
NSB104-120*	7314150316915	1	498
NSB104-17	7314150323357	1	498
NSB104-19	7314150323364	1	498
NSB104-20*	7314150323371	1	498
NSB104-22*	7314150323388	1	498
NSB104-24	7314150316717	1	498
NSB104-25*	7314150323395	1	498
NSB104-26*	7314150323401	1	498
NSB104-27	7314150316724	1	498
NSB104-28*	7314150323418	1	498
NSB104-29	7314150323425	1	498
NSB104-30	7314150316731	1	498
NSB104-31*	7314150323432	1	498
NSB104-32	7314150316748	1	498
NSB104-33*	7314150323449	1	498
NSB104-34*	7314150323456	1	498
NSB104-35*	7314150323463	1	498
NSB104-36	7314150316755	1	498
NSB104-37	7314150323470	1	498
NSB104-38	7314150323487	1	498
NSB104-39*	7314150323494	1	498
NSB104-40*	7314150323500	1	498
NSB104-41	7314150316762	1	498
NSB104-42	7314150323517	1	498
NSB104-43*	7314150323524	1	498
NSB104-44	7314150323531	1	498
NSB104-45*	7314150323548	1	498
NSB104-46	7314150316779	1	498
NSB104-47*	7314150323555	1	498
NSB104-48	7314150323562	1	498
NSB104-49	7314150323579	1	498
NSB104-50	7314150316786	1	498
NSB104-51*	7314150323586	1	498
NSB104-52*	7314150323593	1	498
NSB104-53*	7314150323609	1	498
NSB104-54*	7314150323616	1	498
NSB104-55	7314150316793	1	498
NSB104-56*	7314150323623	1	498
NSB104-57*	7314150323630	1	498
NSB104-58*	7314150323647	1	498
NSB104-59	7314150323654	1	498
NSB104-60	7314150316809	1	498



NSB104-61*	7314150323661	1	498
NSB104-62*	7314150323678	1	498
NSB104-63*	7314150323685	1	498
NSB104-64*	7314150323692	1	498
NSB104-65	7314150316816	1	498
NSB104-66*	7314150323708	1	498
NSB104-67*	7314150323715	1	498
NSB104-68*	7314150323722	1	498
NSB104-69*	7314150323739	1	498
NSB104-70	7314150316823	1	498
NSB104-71*	7314150323746	1	498
NSB104-72*	7314150323753	1	498
NSB104-73*	7314150323760	1	498
NSB104-74*	7314150323777	1	498
NSB104-75	7314150316830	1	498
NSB104-76*	7314150323784	1	498
NSB104-77*	7314150323791	1	498
NSB104-78*	7314150323807	1	498
NSB104-79*	7314150323814	1	498
NSB104-80*	7314150316847	1	498
NSB104-81*	7314150323821	1	498
NSB104-82*	7314150323838	1	498
NSB104-83*	7314150323845	1	498
NSB104-84*	7314150323852	1	498
NSB104-85*	7314150316854	1	498
NSB104-86*	7314150323869	1	498
NSB104-87*	7314150323876	1	498
NSB104-88*	7314150323883	1	498
NSB104-89*	7314150323890	1	498
NSB104-90*	7314150316861	1	498
NSB104-92*	7314150323906	1	498
NSB104-94*	7314150323913	1	498
NSB104-95*	7314150316878	1	498
NSB104-98*	7314150323920	1	498
NSB106-100*	7314150324361	1	499
NSB106-104*	7314150324378	1	499
NSB106-108*	7314150324385	1	499
NSB106-112*	7314150324392	1	499
NSB106-114*	7314150324408	1	499
NSB106-116*	7314150324415	1	499
NSB106-120*	7314150324422	1	499
NSB106-124*	7314150324439	1	499
NSB106-126	7314150324446	1	499
NSB106-128*	7314150324453	1	499
NSB106-132*	7314150324460	1	499
NSB106-136*	7314150324477	1	499
NSB106-138*	7314150324484	1	499
NSB106-144*	7314150324491	1	499
NSB106-146*	7314150324507	1	499
NSB106-150*	7314150324514	1	499
NSB106-156*	7314150324521	1	499
NSB106-158*	7314150324538	1	499
NSB106-20*	7314150323944	1	498
NSB106-22	7314150323951	1	498
NSB106-24*	7314150323968	1	498
NSB106-25*	7314150323975	1	498
NSB106-26*	7314150323982	1	498
NSB106-28	7314150323999	1	498
NSB106-30*	7314150324002	1	498
NSB106-32*	7314150324019	1	498
NSB106-34*	7314150324026	1	498
NSB106-36*	7314150324033	1	498
NSB106-38*	7314150324040	1	498
NSB106-40*	7314150324057	1	498
NSB106-42*	7314150324064	1	498
NSB106-44*	7314150324071	1	498
NSB106-45*	7314150324088	1	498
NSB106-46	7314150324095	1	498
NSB106-48*	7314150324101	1	498
NSB106-50*	7314150324118	1	498
NSB106-52*	7314150324125	1	498
NSB106-54*	7314150324132	1	498
NSB106-56*	7314150324149	1	498
NSB106-58*	7314150324156	1	498
NSB106-60*	7314150324163	1	498
NSB106-62*	7314150324170	1	499
NSB106-64*	7314150324187	1	499
NSB106-66*	7314150324194	1	499
NSB106-68*	7314150324200	1	499
NSB106-70*	7314150324217	1	499
NSB106-71*	7314150324224	1	499
NSB106-72*	7314150324231	1	499
NSB106-74*	7314150324248	1	499
NSB106-76*	7314150324255	1	499
NSB106-78*	7314150324262	1	499
NSB106-80*	7314150324279	1	499
NSB106-82*	7314150324286	1	499
NSB106-84*	7314150324293	1	499
NSB106-88*	7314150324309	1	499



NSB106-90*	7314150324316	1	499
NSB106-92	7314150324323	1	499
NSB106-94*	7314150324330	1	499
NSB106-96*	7314150324347	1	499
NSB106-98*	7314150324354	1	499
NSB200-1200	7314150324613	1	499
NSB200-200	7314150324545	1	499
NSB200-250	7314150324552	1	499
NSB200-300	7314150324569	1	499
NSB200-350	7314150324576	1	499
NSB200-450	7314150324583	1	499
NSB200-600	7314150324590	1	499
NSB200-900	7314150324606	1	499
NSB202-350	7314150324620	1	499
NSB203-200	7314150359561	1	499
NSB203-215	7314150359578	1	499
NSB203-290	7314150359585	1	499
NSB203-400	7314150359592	1	499
NSB203-490	7314150359608	1	499
NSB203-800*	7314150359615	1	499
NSB204-30	7314150324637	1	500
NSB204-32*	7314150324644	1	500
NSB204-35*	7314150324651	1	500
NSB204-40*	7314150324668	1	500
NSB204-45*	7314150324675	1	500
NSB204-48*	7314150324682	1	500
NSB204-50	7314150324699	1	500
NSB204-55*	7314150324705	1	500
NSB204-60	7314150324712	1	500
NSB204-65*	7314150324729	1	500
NSB204-70*	7314150324736	1	500
NSB204-75*	7314150324743	1	500
NSB204-80*	7314150324750	1	500
NSB204-85*	7314150324767	1	500
NSB204-90	7314150324774	1	500
NSB220-06	7314150354023	1	500
NSB220-07	7314150354030	1	500
NSB220-08	7314150354047	1	500
NSB220-09	7314150354054	1	500
NSB220-10	7314150354061	1	500
NSB220-11	7314150354078	1	500
NSB220-12	7314150354085	1	500
NSB220-13	7314150354092	1	500
NSB220-14	7314150354108	1	500
NSB220-15	7314150354115	1	500
NSB220-16	7314150354122	1	500
NSB220-17	7314150354139	1	500
NSB220-18	7314150354146	1	500
NSB220-19	7314150354153	1	500
NSB220-20	7314150354160	1	500
NSB220-21	7314150354177	1	500
NSB220-22	7314150354184	1	500
NSB220-23	7314150354191	1	500
NSB220-24	7314150354207	1	500
NSB220-25	7314150354214	1	500
NSB220-26	7314150354221	1	500
NSB220-27	7314150354238	1	500
NSB220-28	7314150354245	1	500
NSB220-29	7314150354252	1	500
NSB220-30	7314150354269	1	500
NSB220-32	7314150354276	1	500
NSB224-17	7314150355723	1	500
NSB224-18*	7314150355730	1	500
NSB224-19	7314150355747	1	500
NSB224-21*	7314150355754	1	500
NSB224-22	7314150355761	1	500
NSB224-23*	7314150355778	1	500
NSB224-24	7314150355785	1	500
NSB224-26*	7314150355792	1	500
NSB224-27*	7314150355808	1	500
NSB224-28	7314150355815	1	500
NSB224-29*	7314150355822	1	500
NSB224-30	7314150355839	1	500
NSB224-32	7314150355846	1	500
NSB224-34*	7314150355853	1	500
NSB224-36	7314150355860	1	500
NSB224-38*	7314150355877	1	500
NSB224-41	7314150355884	1	500
NSB224-46	7314150355891	1	501
NSB224-50	7314150355907	1	501
NSB228-22*	7314150356126	1	501
NSB228-24*	7314150356133	1	501
NSB228-26*	7314150356140	1	501
NSB228-27*	7314150356157	1	501
NSB228-28*	7314150356164	1	501
NSB228-29*	7314150356171	1	501
NSB228-30*	7314150356188	1	501
NSB228-31*	7314150356195	1	501
NSB228-32*	7314150356201	1	501

* Until stocks last





NSB228-34*	7314150356218	1	501
NSB228-36*	7314150356225	1	501
NSB228-38*	7314150356232	1	501
NSB228-41*	7314150356249	1	501
NSB228-46	7314150356256	1	501
NSB228-50	7314150356263	1	501
NSB228-55*	7314150356270	1	501
NSB228-60*	7314150356287	1	501
NSB228-65*	7314150356294	1	501
NSB228-70*	7314150356300	1	501
NSB228-75*	7314150356317	1	501
NSB228-80*	7314150356324	1	501
NSB232-16-24	7314150356379	1	501
NSB232-24-16	7314150356393	1	501
NSB232-24-32	7314150356386	1	501
NSB232-32-24	7314150356409	1	501
NSB234-16-100	7314150356461	1	501
NSB234-16-200	7314150356478	1	501
NSB234-16-250	7314150356485	1	501
NSB234-24-200	7314150356492	1	501
NSB234-32-250	7314150356508	1	501
NSB236-16	7314150356553	1	502
NSB236-24*	7314150356546	1	502
NSB236-32*	7314150356560	1	502
NSB238-16-250	7314150356621	1	502
NSB238-24-250*	7314150356614	1	502
NSB238-32-300*	7314150356607	1	502
NSB240-16-230*	7314150356744	1	502
NSB242-16	7314150356669	1	502
NSB242-24	7314150356676	1	502
NSB242-32*	7314150356683	1	502
NSB243-16-400	7314150356706	1	502
NSB247-26*	7314150356768	1	503
NSB248-16-52*	7314150356720	1	503
NSB300-10-200	7314150317646	1	503
NSB300-10-300	7314150295845	1	503
NSB300-11-250	7314150317653	1	503
NSB300-11-300	7314150317660	1	503
NSB300-11-350	7314150295852	1	503
NSB300-12-400	7314150295869	1	503
NSB300-13-450	7314150295876	1	503
NSB300-3-50	7314150317530	1	503
NSB300-3-75	7314150317547	1	503
NSB300-4-75	7314150317554	1	503
NSB300-4.5-100	7314150295838	1	503
NSB300-4.5-50	7314150317561	1	503
NSB300-5-100	7314150317585	1	503
NSB300-5-75	7314150317578	1	503
NSB300-6-100	7314150285327	1	503
NSB300-6-125	7314150317592	1	503
NSB300-6-150	7314150317608	1	503
NSB300-7-150	7314150317615	1	503
NSB300-8-150	7314150285334	1	503
NSB300-8-200	7314150317622	1	503
NSB300-9-250	7314150317639	1	503
NSB301-10-200	7314150317974	1	504
NSB301-10-300	7314150317981	1	504
NSB301-3-50	7314150317905	1	504
NSB301-4-100	7314150317912	1	504
NSB301-4-150	7314150317929	1	504
NSB301-5-100	7314150317936	1	504
NSB301-5-200	7314150317943	1	504
NSB301-6-100	7314150317950	1	504
NSB301-8-150	7314150317967	1	504
NSB302-0-50	7314150295883	1	504
NSB302-1-100	7314150285341	1	504
NSB302-2-125	7314150285358	1	504
NSB302-3-150	7314150295890	1	504
NSB302-4-300	7314150295906	1	504
NSB304-0-50	7314150295913	1	504
NSB304-1-100	7314150295920	1	504
NSB304-2-125	7314150295937	1	504
NSB304-3-150	7314150295944	1	504
NSB304-4-300	7314150295951	1	504
NSB320-10	7314150318070	1	504
NSB320-2	7314150317998	1	504
NSB320-3	7314150318001	1	504
NSB320-4	7314150318018	1	504
NSB320-5	7314150318025	1	504
NSB320-6	7314150318032	1	504
NSB320-7	7314150318049	1	504
NSB320-8	7314150318056	1	504
NSB320-9	7314150318063	1	504
NSB400-160	7314150295968	1	504
NSB400-180	7314150285365	1	504
NSB400-200	7314150295975	1	504
NSB402-160	7314150295982	1	505
NSB402-200	7314150285372	1	505
NSB403-160	7314150318179	1	505



NSB403-180	7314150318186	1	505
NSB404-160	7314150318223	1	505
NSB405-160*	7314150318230	1	505
NSB406-160	7314150295999	1	505
NSB406-180	7314150318254	1	505
NSB406-200	7314150296002	1	505
NSB407-160	7314150318285	1	506
NSB408-250	7314150285389	1	506
NSB408-300	7314150318308	1	506
NSB411-200	7314150318315	1	506
NSB412-200	7314150318346	1	506
NSB413-180*	7314150318353	1	506
NSB413-200	7314150318360	1	506
NSB500-1000-FB	7314150324828	1	507
NSB500-1500-FB	7314150324835	1	507
NSB500-2000	7314150324781	1	506
NSB500-2000-FB	7314150324842	1	507
NSB500-2500	7314150324798	1	506
NSB500-2500-FB	7314150324859	1	507
NSB500-3000	7314150324804	1	506
NSB500-3000-FB	7314150324866	1	507
NSB500-3500-FB	7314150324873	1	507
NSB500-4000	7314150324811	1	506
NSB502-1000-FB	7314150316922	1	507
NSB502-10000-FB	7314150316991	1	507
NSB502-12000-FB	7314150318414	1	507
NSB502-1500-FB	7314150318421	1	507
NSB502-2000-FB	7314150316939	1	507
NSB502-2500-FB	7314150316946	1	507
NSB502-3000-FB	7314150316953	1	507
NSB502-450-FB	7314150324880	1	507
NSB502-4500-FB	7314150316960	1	507
NSB502-5000-FB	7314150316977	1	507
NSB502-6800-FB	7314150318452	1	507
NSB502-8000-FB*	7314150316984	1	507
NSB504-100-FB	7314150317004	1	507
NSB504-1000-FB	7314150317059	1	507
NSB504-1500-FB	7314150317066	1	507
NSB504-200-FB	7314150317011	1	507
NSB504-2000-FB	7314150317073	1	507
NSB504-300-FB	7314150317028	1	507
NSB504-500-FB	7314150317035	1	507
NSB504-800-FB	7314150317042	1	507
NSB506-300	7314150324897	1	507
NSB506-300-FB	7314150318490	1	508
NSB506-450	7314150324903	1	507
NSB506-450-FB	7314150318483	1	508
NSB506-700	7314150324910	1	507
NSB506-700-FB	7314150317080	1	508
NSB506-900	7314150324927	1	507
NSB506-900-FB	7314150317097	1	508
NSB508-500-FB	7314150318513	1	508
NSB508-700-FB	7314150318520	1	508
NSB512-200-FB	7314150318643	1	508
NSB512-400-FB	7314150318636	1	508
NSB512-600-FB	7314150318629	1	508
NSB512-900-FB*	7314150318605	1	508
NSB600-100-50	7314150317110	1	508
NSB600-135-50	7314150317127	1	508
NSB600-150-25	7314150317134	1	508
NSB600-150-30	7314150317141	1	508
NSB600-150-40*	7314150317158	1	508
NSB600-150-50	7314150317165	1	508
NSB600-180-13*	7314150317172	1	508
NSB600-180-32	7314150317189	1	508
NSB600-180-50	7314150317196	1	508
NSB600-200-20	7314150317202	1	508
NSB600-200-30	7314150317219	1	508
NSB600-200-40*	7314150317226	1	508
NSB600-200-50	7314150317233	1	508
NSB600-230-40	7314150317240	1	508
NSB600-250-40*	7314150317257	1	508
NSB600-300-50	7314150317264	1	508
NSB600-80-13	7314150317103	1	508
NSB602-460	7314150324934	1	509
NSB602-600	7314150324941	1	509
NSB602-760	7314150324958	1	509
NSB602-900	7314150324965	1	509
NSB604-150*	7314150324972	1	509
NSB604-200*	7314150324989	1	509
NSB604-300*	7314150324996	1	509
NSB606-150	7314150325009	1	509
NSB606-200	7314150325016	1	509
NSB606-250	7314150325023	1	509
NSB606-300	7314150325030	1	509
NSB606-400	7314150325047	1	509
NSB608-100	7314150325054	1	509
NSB700-300	7314150296255	1	510
NSB702-200	7314150296262	1	510



NSB704-225	7314150296279	1	510
NSB706-50	7314150296286	1	510
NSB706-80	7314150296293	1	510
NSB708-360	7314150296309	1	510
NSB710-450	7314150296316	1	511
NSB800-1100	7314150325061	1	511
NSB800-1700	7314150325078	1	511
NSB800-2000	7314150325085	1	511
NSB802-290	7314150325092	1	511
NSB810-100*	7314150318650	1	511
NSB810-150*	7314150318667	1	511
NSB810-200*	7314150318674	1	511
NSB810-350*	7314150318681	1	511
P-HB	7314150125272	25	531
P-MEC	7314150374342	24	531
P-MEC-LEAD	7314150374359	12	531
P1-20	7311518044572	5	607
P1-23	7311518332501	5	607
P108-20-F	7311518275518	2	607
P108-23-F	7311518275525	2	607
P11	7311518009076	6	623
P110-20-F	7311518275532	2	607
P110-23-F	7311518275549	2	607
P114-SL-40	7311518301149	2	611
P114-SL-50	7311518301156	2	611
P114-SL-60	7311518301163	2	611
P116-SL-40	7311518301101	2	611
P116-SL-50	7311518301118	2	611
P116-SL-60	7311518301125	2	611
P116-SL-70	7311518301132	2	611
P121-18-F	7311518275662	6	608
P121-20-F	7311518275631	6	608
P121-23-F	7311518275648	6	608
P123-19-BULK30	7311518218218	30	610
P126-19-F	7311518275297	6	608
P126-22-F	7311518275303	6	608
P127-19-BULK30	7311518199333	30	610
P128-19	7311518160814	6	610
P128-19-BULK30	7311518172329	30	610
P129-19-BULK30	7311518172336	30	610
P130-F	7311518333980	6	612
P138-22-BULK6	7311518328696	6	608
P138-22-F	7311518301279	6	608
P140-F	7311518275372	6	612
P16-40	7311518013479	2	611
P16-40W	7311518043049	2	611
P16-50-F	7311518301286	2	611
P16-60-F	7311518276461	2	611
P160-SL-60	7311518301170	2	611
P160-SL-75	7311518301187	1	611
P160-SL-90	7311518301194	1	611
P173-SL-85	7311518334703	1	611
P19-80-F	7311518275365	1	611
P20	7311518009281	6	623
P241	7311518008956	5	603
P262	7311518299286	10	602
P263	7311518299262	10	602
P264	7311518299279	10	602
P266	7311518299293	10	603
P267	7311518299309	10	602
P268	7311518299316	10	602
P269	7311518299323	10	603
P270	7311518299330	10	603
P272	7311518299354	5	602
P274	7311518299347	5	602
P276	7311518299361	5	603
P277	7311518299378	5	602
P278	7311518299385	5	602
P280-SL-60	7311518346508	2	611
P280-SL-80	7311518301330	2	611
P3-20-F	7311518275259	2	607
P3-23-F	7311518275266	2	607
P34-27A-F	7311518275464	2	614
P34-37	7311518002787	2	614
P5-23-F	7311518275280	2	607
P51-F	7311518275426	2	616
P51-SL	7311518301217	2	616
P51H-SL	7311518301224	2	616
P52-SL-20	7311518347307	2	617
P54-SL-25	7311518301231	2	617
P54H-SL-25	7311518301255	2	617
P57-25-F	7311518301293	4	616
P59-25-F	7311518275655	6	617
P6160	7314150115075	10	632
P64-20-BULK12	7311518288204	12	608
P74	7311518124076	40	618
P75	7311518124083	1	618
PAGS-2.0	7311518327835	1	587
PAGS-2.0-900FG	7311518292355	1	587

* Until stocks last



PBB-8	7314150399376	8	530
PBS-700	7314150341689	6	530
PC-10-DTF	7311518263560	10	554
PC-10-DTL	7311518263553	10	554
PC-10-DTR	7311518263546	10	554
PC-11-19-PS	7311518285548	4	553
PC-11-19-PS-B	7311518285555	10	553
PC-12-14-PS	7311518285562	4	553
PC-12-14-PS-B	7311518285579	10	553
PC-12-COM	7311518263454	4	548
PC-12-TEN	7311518263447	4	552
PC-12-VEN	7311518263430	4	552
PC-15-GNP	7311518264307	4	548
PC-15-TBX	7311518263423	4	552
PC-16-DECO	7311518264987	4	549
PC-16-FILE-U7	7311518263461	4	550
PC-19-FILE-U7	7311518263478	4	550
PC-19-GT7	7311518263362	4	550
PC-19-GT9	7311518263379	4	552
PC-20-LAM	7311518258290	4	551
PC-20-PRC	7311518264291	4	552
PC-22-FILE-U7	7311518263485	4	550
PC-22-GT7	7311518263393	4	550
PC-22-GT9	7311518263409	4	552
PC-22-INS	7314150154500	4	549
PC-22-PLC	7314150276318	4	548
PC-24-FILE-U7	7311518263492	4	550
PC-24-PLS	7311518263508	4	548
PC-24-TIM	7311518263515	4	553
PC-6-DRY	7311518282004	6	548
PC-9-9/17-PS	7311518285586	4	553
PC-9-9/17-PS-B	7311518285593	10	553
PENCIL-200-DISP	7314150125227	1	531
PG-01-F	7311518329334	6	608
PG-03-L	7311518242855	2	608
PG-12-BULK15	7311518334628	15	608
PG-12-F	7311518328122	2	608
PG-18-45-F	7311518299033	10	612
PG-18-60-F	7311518288853	2	612
PG-19-F	7311518295936	2	612
PG-56-F	7311518288938	2	617
PG-57-F	7311518295943	2	617
PG-72	7311518242534	4	620
PH-6604-1P	7311518152819	15	37
PH-6604-25	7311518141134	25	37
PROF-H	7311518158439	1	622
PROF-LOPP	7311518288549	1	622
PROF-SEC	7311518288532	1	622
PROF-TL	7311518335991	4	454
PS501-1	7314150338283	1	637
PS501-2	7314150112432	1	637
PS501-3	7314150338290	1	637
PS501-4	7314150338306	1	637
PU-14*	7314150016266	5	46
PU-20*	7314150016389	3	46
PU-21*	7314150016402	3	46
PU-22*	7314150016426	3	46
PU-23*	7314150016440	3	46
PU-24*	7314150016464	3	46
PU-25*	7314150016488	1	46
PU-26*	7314150016501	1	46
PU-27*	7314150016525	1	46
PU-28*	7314150016549	1	46
PU-29*	7314150016563	1	46
PU-30*	7314150016587	1	46
PU-32*	7314150016600	1	46
PU-36*	7314150016631	1	46
PU-6*	7314150016105	5	46
PU-7*	7314150016129	5	46
PU-8	7314150016143	5	46
PU-9*	7314150016167	5	46
PX-L2	7311518233853	2	606
PX-L3	7311518233860	2	606
PX-M1	7311518233815	2	606
PX-M2	7311518233822	2	606
PX-M2-L	7311518240714	2	606
PX-M3	7311518233839	2	606
PX-S1	7311518233785	2	606
PX-S2	7311518233792	2	606
PXR-L2	7311518233914	2	606
PXR-M1	7311518233877	2	606
PXR-M2	7311518233884	2	606
PXR-M2-L	7311518240738	2	606
PXR-M3	7311518233891	2	606
PXR-S1	7311518240677	2	606
PXR-S2	7311518240684	2	606
PXR-S2-L	7311518346799	2	606
QC-115A	7314150460007	12	574
QC-115A-2P	7314150460021	6	574



QC-150A



QC-150A	7314150460045	6	574
QC-150A-2P	7314150460069	6	574
QC-300A	7314150401925	6	574
QC-300A-2P	7314150460090	4	574
QCB-1250	7314150135981	8	574
QCB-150	7314150135912	6	574
QCB-300	7314150135936	6	574
QCB-450	7314150135950	6	574
QCB-600	7314150135967	4	574
QCB-900	7314150135974	4	574
QCG-150	7314150135899	6	574
QCG-300	7314150135905	6	574
R1068	7311518044398	1	610
R1069P	7311518219574	12	610
R1071	7311518222918	14	611
R1075-BULK50	7311518220495	50	611
R1080P	7311518282479	1	610
R112PG	7311518010058	1	609
R113PG	7311518044374	30	609
R114PG	7311518010065	1	609
R114V	7311518042660	25	612
R114V-BULK28	7311518177539	28	612
R115V	7311518243210	8	612
R115V-BULK14	7311518288341	14	612
R116V	7311518010164	1	612
R116V-BULK36	7311518159924	36	612
R119V	7311518029487	1	612
R122PG	7311518010072	30	609
R123PG	7311518044381	30	609
R124PG	7311518010089	30	609
R1269P-BULK50	7311518240820	50	607
R133PG	7311518328252	1	615
R137E	7311518011574	30	614
R142P	7311518010126	24	609
R143PV	7311518010133	1	612
R143PVCB	7311518255633	1	612
R144PV	7311518291075	24	612
R146VC	7311518046545	22	617
R146VS	7311518046538	24	612
R146VS-BULK50	7311518159955	50	612
R147V	7311518044909	24	617
R148V	7311518223922	1	609
R1601	7311518044640	1	610
R160A	7311518201821	1	612
R160A-BULK28	7311518337216	28	612
R166V	7311518328085	22	612
R16V	7311518254513	1	612
R16V-BULK14	7311518288334	14	612
R185V	7311518331795	25	612
R201P	7311518219536	1	608
R201P-BULK80	7311518225209	80	608
R202P	7311518219550	1	609
R211P	7311518234027	1	606
R211P-BULK80	7311518252212	80	606
R214SL	7311518301392	1	612
R214V	7311518042745	1	612
R214V-BULK28	7311518177553	28	612
R216SL	7311518301408	8	612
R221P	7311518229412	1	608
R221P-BULK50	7311518240653	50	608
R223P	7311518237554	1	609
R223P-BULK80	7311518240646	80	609
R230P	7311518341503	10	614
R239P	7311518219567	1	609
R260A	7311518201814	16	612
R272H	7311518258016	1	613
R300P	7311518234034	1	606
R301P	7311518349189	30	608
R303P	7311518234157	1	606
R304P	7311518349219	1	609
R310-0	7314151829797	1	58
R310-1	7314151829803	1	58
R310-2	7314151829810	1	58
R310-3	7314151829827	1	58
R315V	7311518243234	1	612
R318V	7311518029500	1	612
R328V	7311518296056	22	612
R335V	7311518331801	12	612
R337E	7311518011598	1	615
R341P	7311518011529	12	609
R372H	7311518235406	1	612
R373A	7311518334710	25	612
R403P	7311518234164	1	606
R415V	7311518243241	1	612
R4230	7311518341510	10	614
R427AE	7311518176068	18	615
R434P	7311518223885	1	609
R434P-BULK50	7311518169916	50	609
R437E	7311518011611	18	615



R438P	7311518229429	1	609
R438P-BULK50	7311518240660	50	609
R440V	7311518254544	22	612
R444V	7311518243340	22	617
R463P	7311518223908	1	609
R472H	7311518334840	30	613
R474P	7311518011536	1	609
R478P	7311518275600	1	610
R480P	7311518282486	1	610
R500P	7311518234041	40	606
R503P	7311518234171	1	606
R515VS	7311518046514	22	617
R516V	7311518200824	22	617
R519V	7311518029517	1	612
R600P	7311518240783	1	606
R603P	7311518240790	1	606
R615V	7311518010119	1	612
R619V	7311518029494	1	612
R660V	7311518210281	24	612
R6725MK	7314151088354	1	71
R6725ZK	7314151784898	1	71
R680V	7311518042752	1	612
R6810M-10	7314150195152	5	81
R6810M-3.4	7314150195077	5	81
R6810M-4	7314150195084	5	81
R6810M-4.5	7314150195091	5	81
R6810M-5	7314150195107	5	81
R6810M-6	7314150195114	5	81
R6810M-7	7314150195121	1	81
R6810M-8	7314150195138	5	81
R6810M-9	7314150195145	5	81
R6810Z-1/4	7314150429448	1	81
R6810Z-3/16	7314150429387	1	81
R6810Z-3/8	7314150429394	1	81
R6810Z-5/16	7314150429400	1	81
R6810Z-7/32	7314150429417	1	81
R6822Z	7314150429424	5	82
R6950	7314151089658	1	87
R6964A	7314150195176	1	82
R6967	7314150195169	5	82
R716VCB	7311518255497	40	612
R772V	7311518301385	14	612
R773V	7311518324414	1	612
R775V	7311518331818	1	612
R776V	7311518334734	1	612
R801P	7311518234126	1	606
R802P	7311518234133	1	606
R803P	7311518234140	1	606
R804P	7311518240806	1	606
R811P	7311518234058	1	606
R812P	7311518234065	1	606
R813P	7311518234072	1	606
R815P	7311518240752	1	606
R900P	7311518234188	1	606
R900P-Z	7311518349233	24	609
R901P	7311518234195	30	606
R902P	7311518234201	24	607
R903P	7311518234218	1	607
R904P	7311518234225	1	607
R905P	7311518234232	1	607
R905P-BULK50	7311518252250	50	607
R906P	7311518234249	1	607
R906P-BULK50	7311518252267	50	607
R906P-Z	7311518349264	12	609
R907P	7311518234256	1	607
RAIL-10	7314150511075	10	85
RAIL-340*	7314153003645	3	85
RAIL-8	7314150511051	10	85
RAUNI	7311518339289	6	613
RB-SET-AL06-5P	7314150501489	1	154
RB-SET-M06X-10P	7314150501557	1	154
RB-SET1-M06X-5P	7314150501588	1	154
RB-SET2-M06X-5P	7314150501618	1	154
RBCP	7311518339272	10	614
RBCP230	7311518341558	12	615
RCAM30	7311518346959	20	615
RCAM36	7311518346973	20	615
RD1M	7311518341534	15	615
RD7M	7311518341541	20	615
RPL230G	7311518341527	8	615
RT821P	7311518242237	1	606
RT822P	7311518234102	1	606
RT823P	7311518234119	6	606
RT824P	7311518240776	1	606
RT825P	7311518347147	6	606
RX 01	7314150103263	1	633
RX 7390	7314150342587	10	635
RX 7392	7314150342594	10	635
RX 7490	7314150103195	10	635

RX 7590	7314150103201	10	635
RX 7890	7314150103218	10	635
RX 7891	7314150103225	10	635
RX 7892	7314150103232	10	635
RX 7893	7314150103249	10	636
RX 7894	7314150212101	10	636
RX 8130	7314150103003	10	630
RX 8131	7314150103010	10	630
RX 8132	7314150103027	10	630
RX 8137	7314150392926	10	630
RX 8140	7314150103034	10	630
RX 8141	7314150103041	10	630
RX 8142	7314150103058	10	630
RX 8142PS	7314150349371	10	634
RX 8143	7314150103065	10	630
RX 8144	7314150103072	10	630
RX 8145	7314150103089	10	630
RX 8146	7314150103096	10	630
RX 8147	7314150103102	10	630
RX 8147PS	7314150425402	10	634
RX 8148	7314150103119	10	630
RX 8149	7314150103126	10	632
RX 8150	7314150103133	10	630
RX 8151	7314150103140	10	630
RX 8152	7314150103157	10	630
RX 8153	7314150412976	10	630
RX 8154	7314150351435	10	630
RX 8156	7314150411528	10	630
RX 8157	7314150383733	10	630
RX 8158	7314150117130	10	630
RX 8160	7314150111534	10	630
RX 8161	7314150111541	10	630
RX 8161PS	7314150410750	10	634
RX 8162	7314150111558	10	630
RX 8164	7314150116270	10	630
RX 8165	7314150116287	10	630
RX 8167	7314150383726	10	630
RX 8168	7314150115495	10	630
RX 8211	7314150103188	10	631
RX 8247	7314150103164	10	631
RX 8248	7314150103171	10	632
RX8133	7314150476749	10	630
RX8134	7314150476756	10	630
RX8136	7314150476770	10	630
RX8137MX	7314150358519	10	631
RX8138	7314150346561	10	630
RX8138MX	7314150349395	10	631
RX8140M2	7314150476787	10	634
RX8140PS	7314150360635	10	634
RX8141PS	7314150349432	10	634
RX8143PS	7314150360642	10	634
RX8150M2	7314150476794	10	634
RX8150PS	7314150358502	10	634
RX8155	7314150374014	10	630
RX8160BPS	7314150360048	10	634
RX8160M2	7314150476800	10	634
RX8163	7314150476817	10	630
RX8166	7314150476558	10	630
RX8233A	7314150436279	10	633
RX8234A	7314150436286	10	633
RX8237A	7314150436293	10	633
S0810L	7314150256594	20	65
S103	7314150257119	2	64
S103-CASE	7314150321261	1	107
S106	7314150103997	2	64
S108	7314150122257	2	64
S108-CASE*	7314150349319	1	107
S1214L	7314150256600	10	71
S137	7314150450503	2	65
S138	7314150195022	2	65
S140T	7314150125203	10	72
S140T-R	7314150136353	10	72
S160	7314150104031	6	66
S160-BOX	7314150508518	6	107
S160AF	7314150137510	6	67
S1612L	7314150256617	4	74
S18HEX	7314150412457	4	74
S18TORX	7314150412464	4	74
S240	7314150104017	4	74
S240-SPL	7314150549009	4	74
S240AF	7314150111077	4	75
S240AF-CASE*	7314150187317	1	107
S290	7314153000859	6	66
S330	7314150104024	6	71
S330-CASE*	7314150136223	1	107
S330AF	7314150137503	6	72
S330L	7314150256587	4	72
S330L-CASE*	7311518337674	1	107
S350AF	7314150137527	2	75

* Until stocks last

S380	7314150168934	4	72
S39MH	7314150557301	20	66
S400	7314150111053	2	74
S410	7314153019370	2	64
S410-CASE*	7314150321223	1	107
S460	7314150111060	6	66
S460-CASE	7314150321209	1	107
S4RM-12-15	7314150179954	30	49
S4RM-16-19	7314150179961	50	49
S4RM-21-27	7314150179978	20	49
S4RM-30-36	7314150179985	10	49
S4RM-4-7	7314150179930	60	49
S4RM-8-11	7314150179947	60	49
S4RM/3T	7314150117406	20	49
S4RM/4T	7314150179916	8	50
S4RM/5T	7314150179923	8	50
S530T	7314150169122	4	72
S560	7314150122264	4	65
S560-CASE	7314150321216	1	107
S560MH	7314150547593	4	76
S71MIX	7314150484966	2	64
S800	7314150165599	2	65
S81MIX	7314150180127	2	64
S87+7	7314150103980	2	64
S910	7314150104000	2	64
S95	7314150409167	2	64
S9HEX	7314150412433	10	74
S9TORX	7314150412440	10	74
SB-2448	7314150136056	12	560
SB-2449	7314150194049	10	560
SB-3732-2-125	7314151847869	60	594
SB-3732-2.5-125	7314151847876	60	594
SB-3732-3.2-125	7314151847883	60	594
SB-3732-4-125	7314151847890	1	594
SB-3734N-10-150	7314151848101	1	593
SB-3734N-2-150	7314151847968	1	593
SB-3734N-3-150	7314151847975	1	593
SB-3734N-4-150	7314151847982	60	593
SB-3734N-5-150	7314151847999	1	593
SB-3734N-6-150	7314151848071	60	593
SB-3734N-7-150	7314151848088	1	593
SB-3734N-8-150	7314151848095	1	593
SB-3735N-2-100	7314151847906	1	592
SB-3735N-4-120	7314151847913	60	592
SB-3735N-5-120	7314151847920	1	592
SB-3735N-6-150	7314151847937	1	592
SB-3735N-8-150	7314151847944	1	592
SB-3740-125	7314150115990	87	590
SB-3740-150	7314150116003	25	590
SB-3740-175	7314150116010	25	590
SB-3740-200	7314150116027	25	590
SB-3740-250	7314150116034	25	590
SB-3740-300	7314150116041	25	590
SB-9526/S6	7314150154234	20	160
SB111M-10	7314151839864	1	42
SB111M-11	7314151839871	1	42
SB111M-12	7314151839888	1	42
SB111M-13	7314151839895	1	42
SB111M-14	7314151839901	1	42
SB111M-15	7314151839918	1	42
SB111M-16	7314151839925	1	43
SB111M-17	7314151839932	1	43
SB111M-18	7314151839949	1	43
SB111M-19	7314151839956	1	43
SB111M-20	7314151839963	1	43
SB111M-21	7314151839970	1	43
SB111M-22	7314151839987	1	43
SB111M-23	7314151839994	1	43
SB111M-24	7314151840006	1	43
SB111M-25	7314151840013	1	43
SB111M-26	7314151840020	1	43
SB111M-27	7314151840037	1	43
SB111M-28	7314150432103	1	43
SB111M-29	7314151840051	1	43
SB111M-30	7314151840068	1	43
SB111M-32	7314151840075	1	43
SB111M-5.5	7314151839819	1	42
SB111M-6	7314151839826	1	42
SB111M-7	7314151839833	1	42
SB111M-8	7314151839840	1	42
SB111M-9	7314151839857	1	42
SB141.007.075	7314150282753	1	212
SB141.008.075	7314150282760	1	212
SB141.009.075	7314150282777	1	212
SB141.010.075	7314150282784	1	212
SB141.015.100	7314150282791	1	212
SB141.020.100	7314150282807	1	212
SB141.025.125	7314150282814	1	212



SB141.027.125



SB141.027.125	7314150282821	1	212
SB141.030.150	7314150282838	1	212
SB141.040.150	7314150282845	1	212
SB142.000.075	7314150282579	1	484
SB142.001.080	7314150282586	1	484
SB142.002.100	7314150282593	1	484
SB142.003.150	7314150282609	1	484
SB143.020.100	7314150282852	1	212
SB143.025.100	7314150282869	1	212
SB143.030.100	7314150282876	1	212
SB143.040.100	7314150282883	1	212
SB143.050.100	7314150282890	1	212
SB143.060.125	7314150282906	1	212
SB143.080.150	7314150282913	1	212
SB144.001.100	7314150282951	1	212
SB144.002.125	7314150282968	1	212
SB144.003.150	7314150282975	1	212
SB145.006.100	7314150282920	1	213
SB146.006.100	7314150282937	1	213
SB148.001.080	7314150314577	1	484
SB148.002.100	7314150314584	1	484
SB149.001.080	7314150314591	1	484
SB149.002.100	7314150314607	1	484
SB150.010.100	7314150343492	1	484
SB150.015.125	7314150343515	1	484
SB150.020.125	7314150343577	1	484
SB150.025.150	7314150343584	1	484
SB190.040.075	7314150281985	1	210
SB190.040.100	7314150282098	1	210
SB190.055.100	7314150281992	1	210
SB190.055.125	7314150282005	1	210
SB190.065.125	7314150282012	1	210
SB190.065.150	7314150282029	1	210
SB190.080.150	7314150282036	1	210
SB190.080.175	7314150282043	1	210
SB190.100.200	7314150282050	1	210
SB190.120.250	7314150282067	1	210
SB190.140.250	7314150282074	1	210
SB191.025.075	7314150282081	1	210
SB191.030.075	7314150282104	1	210
SB191.030.100	7314150282111	1	210
SB191.030.200	7314150282128	1	210
SB191.035.100	7314150282135	1	210
SB191.040.100	7314150282142	1	210
SB191.040.125	7314150282159	1	210
SB191.040.250	7314150282166	1	210
SB191.055.125	7314150282173	1	210
SB191.055.150	7314150282180	1	210
SB191.055.300	7314150282197	1	210
SB191.065.150	7314150282203	1	210
SB191.065.300	7314150282210	1	210
SB192.000.075	7314150282357	1	211
SB192.000.200	7314150282364	1	211
SB192.001.100	7314150282371	1	211
SB192.001.250	7314150282388	1	211
SB192.002.125	7314150282395	1	211
SB192.002.300	7314150282401	1	211
SB192.003.150	7314150282418	1	211
SB192.004.200	7314150282425	1	211
SB193.000.075	7314150282456	1	211
SB193.001.100	7314150282463	1	211
SB193.002.125	7314150282470	1	211
SB193.003.150	7314150282487	1	211
SB193.004.200	7314150282494	1	211
SB194.004.075	7314150282616	1	212
SB194.005.075	7314150282623	1	212
SB194.006.075	7314150282630	1	212
SB194.007.075	7314150282647	1	212
SB194.008.075	7314150282654	1	212
SB194.009.075	7314150282661	1	212
SB194.010.075	7314150282678	1	212
SB194.015.100	7314150282685	1	212
SB194.020.100	7314150282692	1	212
SB194.025.125	7314150282708	1	212
SB194.027.125	7314150282715	1	212
SB194.030.150	7314150282722	1	212
SB194.040.150	7314150282739	1	212
SB194.045.150	7314150282746	1	212
SB195.001.025	7314150282432	1	211
SB195.002.025	7314150282449	1	211
SB195.006.050	7314150289516	1	213
SB195.040.025	7314150282227	1	210
SB195.050.025	7314150282234	1	210
SB195.060.025	7314150282241	1	210
SB195.901.025	7314150282500	1	211
SB195.902.025	7314150282517	1	211
SB1952M-10	7314150105205	1	45
SB1952M-12	7314150105229	1	45
SB1952M-13	7314150105236	1	45



SB1952M-14	7314150105243	1	45
SB1952M-17	7314150105274	1	45
SB1952M-19	7314150105298	1	45
SB1952M-24	7314150105342	1	45
SB1952M-7	7314150105441	1	45
SB1952M-8	7314150105458	1	45
SB196.025.075	7314150282258	1	483
SB196.030.100	7314150282265	1	483
SB196.035.100	7314150282272	1	483
SB196.040.100	7314150282289	1	483
SB196.055.125	7314150282296	1	483
SB196.065.150	7314150282302	1	483
SB196.080.175	7314150282326	1	483
SB196.100.200	7314150282333	1	483
SB196.120.200	7314150282340	1	483
SB197.000.075	7314150282524	1	484
SB197.001.080	7314150282531	1	484
SB197.002.100	7314150282548	1	484
SB197.003.150	7314150282555	1	484
SB197.004.200	7314150282562	1	484
SB198.040.125	7314150282982	1	213
SB198.045.125	7314150282999	1	213
SB198.050.150	7314150283002	1	213
SB198.055.150	7314150283019	1	213
SB198.060.150	7314150283026	1	213
SB198.060.150F	7314150283033	1	214
SB198.070.150	7314150283040	1	213
SB198.070.150F	7314150283057	1	214
SB198.080.150	7314150283064	1	213
SB198.080.150F	7314150283071	1	214
SB198.090.150	7314150283088	1	213
SB198.100.150	7314150283095	1	213
SB198.110.150	7314150283101	1	213
SB198.120.150	7314150283118	1	213
SB198.130.150	7314150283125	1	213
SB198.140.150	7314150283132	1	213
SB199.055.125	7314150283149	1	484
SB199.060.125	7314150283156	1	484
SB199.070.125	7314150283163	1	484
SB199.080.125	7314150283170	1	484
SB199.090.125	7314150283187	1	484
SB199.100.125	7314150283194	1	484
SB199.110.125	7314150283200	1	484
SB199.120.125	7314150287765	1	484
SB199.130.125	7314150287796	1	484
SB2058/S26	7314150557455	12	175
SB2446-EL	7314150312207	10	570
SB2446-LAP	7314150539475	10	569
SB27M-10-11	7314150180851	10	60
SB27M-12-13	7314150180868	10	60
SB27M-14-15	7314150180875	10	60
SB27M-16-17	7314150180882	10	60
SB27M-18-19	7314150180899	10	60
SB27M-20-22	7314150180905	10	60
SB27M-21-23	7314150180912	5	60
SB27M-24-26	7314150180929	5	60
SB27M-6-7	7314150180837	10	60
SB27M-8-9	7314150180844	10	60
SB28M-10	7314150485987	10	58
SB28M-11	7314150486007	10	58
SB28M-12	7314150486021	10	58
SB28M-13	7314150486045	10	58
SB28M-14	7314150486052	10	58
SB28M-15	7314150486076	10	58
SB28M-16	7314150486090	5	58
SB28M-17	7314150486113	5	58
SB28M-18	7314150486137	5	58
SB28M-19	7314150486151	5	58
SB28M-20	7314150486854	4	58
SB28M-21	7314150486878	4	58
SB28M-22	7314150486892	4	58
SB28M-23	7314150486915	4	58
SB28M-24	7314150486939	4	58
SB28M-6	7314150486175	10	58
SB28M-7	7314150486199	10	58
SB28M-8	7314150486212	10	58
SB28M-9	7314150486236	10	58
SB3654BM-15	7314150270897	5	596
SB3654BM-20	7314150270903	5	596
SB3734BM-10	7314150271092	5	596
SB3734BM-3	7314150270996	5	596
SB3734BM-4	7314150271016	5	596
SB3734BM-5	7314150271030	5	596
SB3734BM-6	7314150271054	5	596
SB3734BM-8	7314150271078	5	596
SB3755BM-4	7314150270934	1	596
SB3755BM-6	7314150270958	5	596
SB6700SM-10	7314150104383	1	81
SB6700SM-11	7314150104390	1	81



SB6700SM-12	7314150104406	1	81
SB6700SM-13	7314150104413	1	81
SB6700SM-14	7314150104420	1	81
SB6700SM-4	7314150104307	1	81
SB6700SM-4.5	7314150104314	1	81
SB6700SM-5	7314150104321	1	81
SB6700SM-5.5	7314150104338	1	81
SB6700SM-6	7314150104345	1	81
SB6700SM-7	7314150104352	1	81
SB6700SM-8	7314150104369	1	81
SB6700SM-9	7314150104376	1	81
SB6700SZ-1/2	7314150240609	1	81
SB6700SZ-1/4	7314150240616	1	81
SB6700SZ-1/8	7314150412495	5	81
SB6700SZ-11/32	7314150240623	1	81
SB6700SZ-3/16	7314150240630	1	81
SB6700SZ-3/8	7314150240647	1	81
SB6700SZ-5/16	7314150240654	1	81
SB6700SZ-5/32	7314150240661	1	81
SB6700SZ-7/16	7314150240678	1	81
SB6700SZ-7/32	7314150240685	1	81
SB6700SZ-9/16	7314150240692	1	81
SB6700TORX-E4	7314150240722	1	81
SB6700TORX-E5	7314150240739	1	81
SB6700TORX-E6	7314150240746	1	81
SB6700TORX-E7	7314150240753	1	81
SB6700TORX-E8	7314150240760	1	81
SB6709F-5.5	7314150240784	1	85
SB6709F-8	7314150240807	1	85
SB6709M-4	7314150240821	1	86
SB6709M-5	7314150240838	1	86
SB6709M-6	7314150240845	1	86
SB6709M-8	7314150240852	1	86
SB6709PH-1	7314150240869	1	85
SB6709PH-2	7314150240876	1	85
SB6709PH-3	7314150240883	1	85
SB6709PZ-1	7314150240890	1	85
SB6709PZ-2	7314150240906	1	85
SB6709PZ-3	7314150240913	1	85
SB6709TORX-R-T10*	7314150240975	1	86
SB6709TORX-R-T15*	7314150240937	1	86
SB6709TORX-R-T20*	7314150240944	1	86
SB6709TORX-R-T25*	7314150240951	1	86
SB6709TORX-R-T8*	7314150240968	1	86
SB6709TORX-T10	7314150240982	1	86
SB6709TORX-T15	7314150240999	1	86
SB6709TORX-T20	7314150241002	1	86
SB6709TORX-T25	7314150241019	1	86
SB6709TORX-T27	7314150241026	1	86
SB6709TORX-T30	7314150241033	1	86
SB6709TORX-T40	7314150241040	1	86
SB6709TORX-T8	7314150241057	1	86
SB6709TORX-T9	7314150241064	1	86
SB6950	7314150104987	1	87
SB6950CBR	7314150548132	1	88
SB6950MH	7314150553112	1	87
SB6950MHS	7314150553129	1	87
SB6950QR	7314150548118	1	87
SB6950QRS	7314150548125	1	87
SB6950RN	7314150104994	1	87
SB6954-5	7314150512188	1	83
SB6956	7314150241071	1	83
SB6958-6	7314150500833	1	83
SB6960-14	7314150512201	1	84
SB6960-3	7314150512225	1	84
SB6960-6	7314150512249	1	84
SB6960F-6	7314150522385	1	84
SB6961*	7314150104932	1	84
SB6966	7314150241095	1	84
SB6973A	7314150507214	1	84
SB6M-10-11	7314150105731	1	50
SB6M-12-13	7314150105762	1	50
SB6M-14-15	7314150105823	1	50
SB6M-16-17	7314150105847	1	50
SB6M-17-19	7314150189830	1	50
SB6M-18-19	7314150105878	1	50
SB6M-20-22	7314150105915	1	50
SB6M-21-23	7314150105922	1	50
SB6M-22-24	7314150105946	1	50
SB6M-24-26	7314150105953	1	50
SB6M-24-27	7314150105960	1	50
SB6M-25-28	7314150189847	1	50
SB6M-27-29	7314150189854	1	50
SB6M-30-32	7314150106011	1	50
SB6M-4-5	7314150106042	1	50
SB6M-6-7	7314150106073	1	50
SB6M-8-9	7314150106103	1	50
SB705.1/4.125	7314150283231	1	223
SB7400SM-10	7314150241101	1	88

* Until stocks last



SB7400SM-11	7314150241118	1	88
SB7400SM-12	7314150241125	1	88
SB7400SM-13	7314150241132	1	88
SB7400SM-14	7314150241149	1	88
SB7400SM-15	7314150241156	1	88
SB7400SM-16	7314150241170	1	88
SB7400SM-17	7314150241187	1	88
SB7400SM-18	7314150241194	1	88
SB7400SM-19	7314150241200	1	88
SB7400SM-20	7314150241217	1	88
SB7400SM-21	7314150241224	1	88
SB7400SM-22	7314150241231	1	88
SB7400SM-6	7314150241248	1	88
SB7400SM-7	7314150241255	1	88
SB7400SM-8	7314150241262	1	88
SB7400SM-9	7314150241279	1	88
SB7400TORX-E10	7314150241286	1	90
SB7400TORX-E11	7314150241293	1	90
SB7400TORX-E12	7314150241309	1	90
SB7400TORX-E14	7314150241316	1	90
SB7400TORX-E16	7314150241323	1	90
SB7400TORX-E18	7314150241330	1	90
SB7400TORX-E8	7314150241347	1	90
SB7409BH-10*	7314150241354	1	94
SB7409BH-4*	7314150241361	1	94
SB7409BH-5*	7314150241378	1	94
SB7409BH-6*	7314150241385	1	94
SB7409BH-8*	7314150241392	1	94
SB7409F-10	7314150241408	1	93
SB7409F-6.5	7314150241415	1	93
SB7409F-8	7314150241422	1	93
SB7409M-10	7314150241439	1	94
SB7409M-3	7314150241446	1	94
SB7409M-4	7314150241453	1	94
SB7409M-5	7314150241460	1	94
SB7409M-6	7314150241477	1	94
SB7409M-7	7314150241484	1	94
SB7409M-8	7314150241491	1	94
SB7409PH-1	7314150241507	1	93
SB7409PH-2	7314150241514	1	93
SB7409PH-3	7314150241521	1	93
SB7409TORX-R-T27	7314150241538	1	93
SB7409TORX-R-T30	7314150241545	1	93
SB7409TORX-R-T40	7314150241552	1	93
SB7409TORX-R-T45	7314150241569	1	93
SB7409TORX-R-T50	7314150241576	1	93
SB7409TORX-T20	7314150241583	1	93
SB7409TORX-T25	7314150241590	1	93
SB7409TORX-T27	7314150241613	1	93
SB7409TORX-T30	7314150241620	1	93
SB7409TORX-T30-L*	7314150241637	1	94
SB7409TORX-T40	7314150241644	1	93
SB7409TORX-T40-L*	7314150241651	1	94
SB7409TORX-T45	7314150241668	1	93
SB7409TORX-T45-L*	7314150241675	1	94
SB7409TORX-T50	7314150241682	1	93
SB7409TORX-T50-L*	7314150241699	1	94
SB7750	7314150187850	1	92
SB7750QR	7314150548101	1	92
SB7750RN	7314153003966	1	92
SB7756	7314150489176	1	90
SB7758-10	7314150500840	1	90
SB7759	7314150254859	1	91
SB7762	7314153004000	1	91
SB7766	7314150241743	1	91
SB7767	7314150254897	1	85
SB7771	7314150553990	1	91
SB7773A	7314150516209	1	92
SB7800DM-10	7314150104451	1	96
SB7800DM-11	7314150104468	1	96
SB7800DM-12	7314150104475	1	96
SB7800DM-13	7314150104482	1	96
SB7800DM-14	7314150104499	1	96
SB7800DM-15	7314150104505	1	96
SB7800DM-16	7314150104512	1	96
SB7800DM-17	7314150104529	1	96
SB7800DM-18	7314150104536	1	96
SB7800DM-19	7314150104543	1	96
SB7800DM-20	7314150104550	1	96
SB7800DM-21	7314150104567	1	96
SB7800DM-22	7314150104574	1	96
SB7800DM-23	7314150104581	1	96
SB7800DM-24	7314150104598	1	96
SB7800DM-25	7314150104604	1	96
SB7800DM-26	7314150104611	1	96
SB7800DM-27	7314150104628	1	96
SB7800DM-28	7314150104635	1	96
SB7800DM-29	7314150104642	1	96
SB7800DM-30	7314150104659	1	96



SB7800DM-31



SB7800DM-31	7314150471171	1	96
SB7800DM-32	7314150104666	1	96
SB7800DM-33	7314150240319	1	96
SB7800DM-34	7314150327607	1	96
SB7800DM-36	7314150104673	1	96
SB7800DM-8	7314150104437	1	96
SB7800DM-9	7314150104444	1	96
SB7800DZ-1	7314150234912	1	96
SB7800DZ-1.1/16	7314150240326	1	96
SB7800DZ-1.1/2	7314150524518	1	96
SB7800DZ-1.1/4	7314150240333	1	96
SB7800DZ-1.1/8	7314150240340	1	96
SB7800DZ-1.3/16	7314150240357	1	96
SB7800DZ-1.3/8	7314150524525	1	96
SB7800DZ-1.5/16	7314150240364	1	96
SB7800DZ-1.7/16	7314150524532	1	96
SB7800DZ-1/2	7314150234899	1	96
SB7800DZ-11/16	7314150234929	1	96
SB7800DZ-11/32	7314150524549	1	96
SB7800DZ-13/16	7314150234936	1	96
SB7800DZ-13/32	7314150524556	1	96
SB7800DZ-15/16	7314150234943	1	96
SB7800DZ-19/32	7314150240371	1	96
SB7800DZ-25/32	7314150240388	1	96
SB7800DZ-3/4	7314150234950	1	96
SB7800DZ-3/8	7314150234967	1	96
SB7800DZ-5/16	7314150524563	1	96
SB7800DZ-5/8	7314150234974	1	96
SB7800DZ-7/16	7314150234981	1	96
SB7800DZ-7/8	7314150234998	1	96
SB7800DZ-9/16	7314150235001	1	96
SB7800SM-10	7314150104703	1	95
SB7800SM-11	7314150104710	1	95
SB7800SM-12	7314150104727	1	95
SB7800SM-13	7314150104734	1	95
SB7800SM-14	7314150104741	1	95
SB7800SM-15	7314150104758	1	95
SB7800SM-16	7314150104765	1	95
SB7800SM-17	7314150104772	1	95
SB7800SM-18	7314150104789	1	95
SB7800SM-19	7314150104796	1	95
SB7800SM-20	7314150240395	1	95
SB7800SM-21	7314150104819	1	95
SB7800SM-22	7314150104826	1	95
SB7800SM-23	7314150104833	1	95
SB7800SM-24	7314150104840	1	95
SB7800SM-25	7314150104857	1	95
SB7800SM-26	7314150104864	1	95
SB7800SM-27	7314150104871	1	95
SB7800SM-28	7314150104888	1	95
SB7800SM-29	7314150240401	1	95
SB7800SM-30	7314150104895	1	95
SB7800SM-32	7314150104901	1	95
SB7800SM-33	7314150240418	1	95
SB7800SM-34	7314150235018	1	95
SB7800SM-36	7314150235025	1	95
SB7800SM-8	7314150104680	1	95
SB7800SM-9	7314150104697	1	95
SB7800TORX-E10	7314150240104	1	97
SB7800TORX-E11	7314150240111	1	97
SB7800TORX-E12	7314150240128	1	97
SB7800TORX-E14	7314150240135	1	97
SB7800TORX-E16	7314150240142	1	97
SB7800TORX-E18	7314150240159	1	97
SB7800TORX-E20	7314150240166	1	97
SB7800TORX-E24	7314150240173	1	97
SB7800TORX-E8	7314150240180	1	97
SB7805DM-10	7314150234851	1	97
SB7805DM-12	7314150234868	1	97
SB7805DM-13	7314150235032	1	97
SB7805DM-14	7314150235049	1	97
SB7805DM-15	7314150235056	1	97
SB7805DM-16	7314150235063	1	97
SB7805DM-17	7314150235070	1	97
SB7805DM-18	7314150235087	1	97
SB7805DM-19	7314150235094	1	97
SB7805DM-21	7314150235100	1	97
SB7805DM-22	7314150235117	1	97
SB7805DM-23	7314150327614	1	97
SB7805DM-24	7314150235124	1	97
SB7805DM-26	7314150240197	1	97
SB7805DM-27	7314150235131	1	97
SB7805DM-30	7314150235148	1	97
SB7805DM-32	7314150240203	1	97
SB7805DM-34	7314150521852	1	97
SB7805SM-10	7314150235155	1	95
SB7805SM-11	7314150524501	1	95
SB7805SM-12	7314150235162	1	95
SB7805SM-13	7314150235179	1	95



SB7805SM-14	7314150235193	1	95
SB7805SM-15	7314150235216	1	95
SB7805SM-16	7314150240210	1	95
SB7805SM-17	7314150235223	1	95
SB7805SM-18	7314150235230	1	95
SB7805SM-19	7314150235247	1	95
SB7805SM-20	7314150240227	1	95
SB7805SM-21	7314150235254	1	95
SB7805SM-22	7314150235261	1	95
SB7805SM-23	7314150240234	1	95
SB7805SM-24	7314150235278	1	95
SB7805SM-25	7314150240241	1	95
SB7805SM-26	7314150240258	1	95
SB7805SM-27	7314150235285	1	95
SB7805SM-28	7314150240265	1	95
SB7805SM-29	7314150240272	1	95
SB7805SM-30	7314150235292	1	95
SB7805SM-32	7314150235308	1	95
SB7805SM-34	7314150498284	1	95
SB7807H	7314150467297	1	184
SB7808H	7314150467303	1	184
SB7809H	7314150467341	1	184
SB7809M-10	7314153004185	1	100
SB7809M-10-120	7314150555574	1	101
SB7809M-12	7314153004208	1	100
SB7809M-12-120	7314150555581	1	101
SB7809M-14	7314153004215	1	100
SB7809M-14-120	7314150555598	1	101
SB7809M-17	7314153004222	1	100
SB7809M-17-120	7314150555604	1	101
SB7809M-19	7314153004239	1	100
SB7809M-19-120	7314150555611	1	101
SB7809M-4	7314150313952	1	100
SB7809M-4-120	7314150555550	1	101
SB7809M-5	7314153004109	1	100
SB7809M-5-100*	7314150313969	1	101
SB7809M-5-120	7314150555208	1	101
SB7809M-5-180	7314153004116	1	101
SB7809M-6	7314153004123	1	100
SB7809M-6-120	7314150555543	1	101
SB7809M-7	7314153004130	1	100
SB7809M-7-120	7314150555567	1	101
SB7809M-8	7314153004154	1	100
SB7809M-8-120	7314153004161	1	101
SB7809M-9	7314153004178	1	100
SB7809TORX-T20	7314153004017	1	100
SB7809TORX-T25	7314153004024	1	100
SB7809TORX-T27	7314153004031	1	100
SB7809TORX-T30	7314153004048	1	100
SB7809TORX-T40	7314153004055	1	100
SB7809TORX-T45	7314153004062	1	100
SB7809TORX-T50	7314153004079	1	100
SB7809TORX-T55	7314153004086	1	100
SB7809TORX-T60	7314153004093	1	100
SB81-SET1	7314150538942	8	102
SB8150-1/2	7314150105014	1	101
SB8150QR	7314150548095	1	101
SB8150RN-1/2	7314150105007	1	101
SB8154-11	7314150472178	1	98
SB8157-10	7314150474073	1	97
SB8157-15	7314150472468	1	97
SB8157-24	7314150474080	1	97
SB8157-36	7314150474097	1	97
SB8158-10	7314150488780	1	97
SB8158-15	7314150488797	1	97
SB8160-10	7314150472185	1	98
SB8160-3	7314150472192	1	98
SB8160-5	7314150472208	1	98
SB8166	7314150472154	1	98
SB8171	7314150479016	1	98
SB8172	7314150479023	1	99
SBA6700DM-10	7314150235575	1	82
SBA6700DM-11	7314150241750	1	82
SBA6700DM-12	7314150241767	1	82
SBA6700DM-13	7314150241774	1	82
SBA6700DM-14	7314150241781	1	82
SBA6700DM-5	7314150255054	1	82
SBA6700DM-5.5	7314150241798	1	82
SBA6700DM-6	7314150241804	1	82
SBA6700DM-7	7314150241811	1	82
SBA6700DM-8	7314150241828	1	82
SBA6700DM-9	7314150241835	1	82
SBA6709M-2.5	7314150254835	1	86
SBA6709M-3	7314150254828	1	86
SBA6709M-4	7314150254811	1	86
SBA6709M-5	7314150254804	1	86
SBA6709M-6	7314150254798	1	86
SBA6709Z-1/8	7314150254781	1	86
SBA6709Z-3/16	7314150254774	1	86



SBA6709Z-5/32	7314150254767	1	86
SBA6709Z-9/64	7314150254750	1	86
SBA6800DM-10	7314150250172	1	82
SBA6800DM-11	7314150250189	1	82
SBA6800DM-12	7314150250196	1	82
SBA6800DM-13	7314150250202	1	82
SBA6800DM-14	7314150250219	1	82
SBA6800DM-4	7314150250226	1	82
SBA6800DM-5	7314150250233	1	82
SBA6800DM-5.5	7314150250240	1	82
SBA6800DM-6	7314150250257	1	82
SBA6800DM-7	7314150250264	1	82
SBA6800DM-8	7314150250271	1	82
SBA6800DM-9	7314150250288	1	82
SBA6800DZ-1/2	7314150250295	1	83
SBA6800DZ-1/4	7314150250301	1	83
SBA6800DZ-11/32	7314150250318	1	83
SBA6800DZ-3/16	7314150250325	1	83
SBA6800DZ-3/8	7314150250332	1	83
SBA6800DZ-5/16	7314150250349	1	83
SBA6800DZ-7/16	7314150250356	1	83
SBA6800DZ-7/32	7314150250363	1	83
SBA6800DZ-9/16	7314150250370	1	83
SBA6800DZ-9/32	7314150250387	1	83
SBA7400DM-10	7314150241941	1	89
SBA7400DM-11	7314150241958	1	89
SBA7400DM-12	7314150241965	1	89
SBA7400DM-13	7314150241972	1	89
SBA7400DM-14	7314150241989	1	89
SBA7400DM-15	7314150241996	1	89
SBA7400DM-16	7314150242009	1	89
SBA7400DM-17	7314150242016	1	89
SBA7400DM-18	7314150242023	1	89
SBA7400DM-19	7314150242030	1	89
SBA7400DM-20	7314150242047	1	89
SBA7400DM-21	7314150242054	1	89
SBA7400DM-22	7314150242061	1	89
SBA7400DM-6	7314150242078	1	88
SBA7400DM-7	7314150242085	1	88
SBA7400DM-8	7314150242092	1	89
SBA7400DM-9	7314150242108	1	89
SBA7400DZ-1/2	7314150254705	1	89
SBA7400DZ-1/4	7314150242115	1	89
SBA7400DZ-11/16	7314150242122	1	89
SBA7400DZ-13/16	7314150242139	1	89
SBA7400DZ-17/32	7314150242146	1	89
SBA7400DZ-19/32	7314150242153	1	89
SBA7400DZ-3/4	7314150242160	1	89
SBA7400DZ-3/8	7314150242177	1	89
SBA7400DZ-5/16	7314150242184	1	89
SBA7400DZ-5/8	7314150242191	1	89
SBA7400DZ-7/16	7314150242207	1	89
SBA7400DZ-7/8	7314150242214	1	89
SBA7400DZ-9/16	7314150242221	1	89
SBA7402DM-10	7314150250394	1	89
SBA7402DM-11	7314150250400	1	89
SBA7402DM-12	7314150250417	1	89
SBA7402DM-13	7314150250424	1	89
SBA7402DM-14	7314150250431	1	89
SBA7402DM-15	7314150250448	1	89
SBA7402DM-16	7314150250455	1	89
SBA7402DM-17	7314150250462	1	89
SBA7402DM-18	7314150250479	1	89
SBA7402DM-19	7314150250486	1	89
SBA7402DM-7	7314150250493	1	89
SBA7402DM-8	7314150250509	1	89
SBA7402DM-9	7314150250516	1	89
SBA7402DZ-1/2	7314150250523	1	90
SBA7402DZ-1/4	7314150250530	1	90
SBA7402DZ-11/16	7314150250547	1	90
SBA7402DZ-13/16	7314150250554	1	90
SBA7402DZ-19/32	7314150250561	1	90
SBA7402DZ-3/4	7314150250578	1	90
SBA7402DZ-3/8	7314150250585	1	90
SBA7402DZ-5/16	7314150250592	1	90
SBA7402DZ-5/8	7314150250608	1	90
SBA7402DZ-7/16	7314150250615	1	90
SBA7402DZ-7/8	7314150250622	1	90
SBA7402DZ-9/16	7314150250639	1	90
SBA7402SM-10	7314150561124	1	90
SBA7402SM-11	7314150561131	1	90
SBA7402SM-12	7314150561148	1	90
SBA7402SM-13	7314150561155	1	90
SBA7402SM-14	7314150561162	1	90
SBA7402SM-15	7314150561179	1	90
SBA7402SM-16	7314150561186	1	90
SBA7402SM-17	7314150561193	1	90
SBA7402SM-18	7314150561209	1	90
SBA7402SM-19	7314150561216	1	90

* Until stocks last



SBA7402SM-20	7314150561223	1	90
SBA7402SM-22	7314150561230	10	90
SBA7402SM-6	7314150561247	1	90
SBA7402SM-7	7314150561254	1	90
SBA7402SM-8	7314150561261	1	90
SBA7402SM-9	7314150561278	1	90
SBC110-65	7314150456246	1	561
SBE-8135TB	7314150320424	1	205
SBE-8145TB	7314150320431	1	205
SBE-8150TB	7314150320448	1	205
SBE-8155TB	7314150320455	1	205
SBE-8610TB	7314150320493	1	205
SBE-8620TB	7314150320509	1	205
SBE-8810TB	7314150320530	1	205
SBE-8820TB	7314150320547	1	205
SBE-8915TB	7314150320585	1	206
SBE-8920TB	7314150320592	1	206
SBE-8925TB	7314150320608	1	206
SBE-8930TB	7314150320622	1	206
SBE-8940TB	7314150320639	1	206
SBK6701M-10	7314150445233	1	179
SBK6701M-11	7314150445240	1	179
SBK6701M-12	7314150445264	1	179
SBK6701M-13	7314150445271	1	179
SBK6701M-14	7314150445288	1	179
SBK6701M-6	7314150445196	1	179
SBK6701M-7	7314150445202	1	179
SBK6701M-8	7314150445219	1	179
SBK6701M-9	7314150445226	1	179
SBK7401M-10	7314150445325	1	180
SBK7401M-11	7314150445332	1	180
SBK7401M-12	7314150445349	1	180
SBK7401M-13	7314150445356	1	180
SBK7401M-14	7314150445363	1	180
SBK7401M-15	7314150445370	1	180
SBK7401M-16	7314150445387	1	180
SBK7401M-17	7314150445394	1	180
SBK7401M-18	7314150445400	1	180
SBK7401M-19	7314150445417	1	180
SBK7401M-20	7314150445424	1	180
SBK7401M-21	7314150445431	1	180
SBK7401M-22	7314150445448	1	180
SBK7401M-24	7314150445455	1	180
SBK7401M-7	7314150445295	1	180
SBK7401M-8	7314150445301	1	180
SBK7401M-9	7314150445318	1	180
SBK7764D	7314150447800	1	184
SBK7801M-10	7314150445486	1	182
SBK7801M-11	7314150445493	1	182
SBK7801M-12	7314150445509	1	182
SBK7801M-13	7314150445516	1	182
SBK7801M-14	7314150445523	1	182
SBK7801M-15	7314150445530	1	182
SBK7801M-16	7314150445547	1	182
SBK7801M-17	7314150445554	1	182
SBK7801M-18	7314150445561	1	182
SBK7801M-19	7314150445578	1	182
SBK7801M-20	7314150445585	1	182
SBK7801M-21	7314150445592	1	182
SBK7801M-22	7314150445608	1	182
SBK7801M-23	7314150445615	1	182
SBK7801M-24	7314150445622	1	182
SBK7801M-25	7314150445639	1	182
SBK7801M-26	7314150445646	1	182
SBK7801M-27	7314150445653	1	182
SBK7801M-28	7314150450763	1	182
SBK7801M-29	7314150450770	1	182
SBK7801M-30	7314150445660	1	182
SBK7801M-32	7314150445677	1	182
SBK7801M-34	7314150445684	1	182
SBK7801M-36	7314150445691	1	182
SBK7801M-8	7314150445462	1	182
SBK7801M-9	7314150445479	1	182
SBK7801Z-1	7314150448036	1	183
SBK7801Z-1.1/16	7314150448142	1	183
SBK7801Z-1.1/2	7314150448203	1	183
SBK7801Z-1.1/4	7314150448166	1	183
SBK7801Z-1.1/8	7314150448159	1	183
SBK7801Z-1.3/8	7314150448180	1	183
SBK7801Z-1.5/16	7314150448173	1	183
SBK7801Z-1.7/16	7314150448197	1	183
SBK7801Z-1/2	7314150448067	1	183
SBK7801Z-11/16	7314150448098	1	183
SBK7801Z-13/16	7314150448111	1	183
SBK7801Z-15/16	7314150448135	1	183
SBK7801Z-3/4	7314150448104	1	183
SBK7801Z-3/8	7314150448043	1	183
SBK7801Z-5/8	7314150448081	1	183
SBK7801Z-7/16	7314150448050	1	183



SBK7801Z-7/8



SBK7801Z-7/8	7314150448128	1	183
SBK7801Z-9/16	7314150448074	1	183
SBK7806M-10	7314150447831	1	182
SBK7806M-11	7314150447862	1	182
SBK7806M-12	7314150447879	1	182
SBK7806M-13	7314150447886	1	182
SBK7806M-14	7314150447893	1	182
SBK7806M-15	7314150447909	1	182
SBK7806M-16	7314150447916	1	182
SBK7806M-17	7314150447923	1	182
SBK7806M-18	7314150447930	1	182
SBK7806M-19	7314150447947	1	182
SBK7806M-21	7314150447954	1	182
SBK7806M-22	7314150447961	1	182
SBK7806M-23	7314150447978	1	182
SBK7806M-24	7314150447985	1	182
SBK7806M-27	7314150447992	1	182
SBK7806M-30	7314150448005	1	182
SBK7806M-32	7314150448012	1	182
SBK7806M-36	7314150448029	1	182
SBK7806Z-1	7314150448401	1	183
SBK7806Z-1.1/16	7314150448418	1	183
SBK7806Z-1.1/2	7314150448470	1	183
SBK7806Z-1.1/4	7314150448432	1	183
SBK7806Z-1.1/8	7314150448425	5	183
SBK7806Z-1.3/8	7314150448456	5	183
SBK7806Z-1.5/16	7314150448449	1	183
SBK7806Z-1.7/16	7314150448463	5	183
SBK7806Z-1/2	7314150448326	10	183
SBK7806Z-11/16	7314150448357	1	183
SBK7806Z-13/16	7314150448371	1	183
SBK7806Z-15/16	7314150448395	1	183
SBK7806Z-3/4	7314150448364	1	183
SBK7806Z-3/8	7314150448302	10	183
SBK7806Z-5/8	7314150448340	5	183
SBK7806Z-7/16	7314150448319	10	183
SBK7806Z-7/8	7314150448388	1	183
SBK7806Z-9/16	7314150448333	10	183
SBK8160D-1	7314150447770	1	184
SBK8160D-2	7314150447787	1	184
SBK8160D-3	7314150447794	1	184
SBK8901M-17	7314150448487	1	186
SBK8901M-18	7314150448494	1	186
SBK8901M-19	7314150448500	1	186
SBK8901M-21	7314150448517	1	186
SBK8901M-22	7314150448524	1	186
SBK8901M-23	7314150448531	1	186
SBK8901M-24	7314150448548	1	186
SBK8901M-27	7314150448555	1	186
SBK8901M-28	7314150448562	1	186
SBK8901M-29	7314150448579	1	186
SBK8901M-30	7314150448586	1	186
SBK8901M-32	7314150448593	1	186
SBK8901M-33	7314150448609	1	186
SBK8901M-34	7314150448616	1	186
SBK8901M-36	7314150448623	1	186
SBK8901M-38	7314150448630	1	186
SBK8901M-41	7314150448647	1	186
SBK8901M-46	7314150448654	1	186
SBK8901M-50	7314150448661	1	186
SBK8901M-55	7314150448678	1	186
SBK8901M-60	7314150448685	1	186
SBK8964D	7314150447817	1	184
SBS19-TH10	7314150190072	1	94
SBS19-TH11	7314150190089	1	94
SBS19-TH12	7314150190096	1	94
SBS19-TH13	7314150190102	1	94
SBS19-TH14	7314150190119	1	94
SBS19-TH15	7314150190126	1	94
SBS19-TH16	7314150190133	1	94
SBS19-TH17	7314150190140	1	94
SBS19-TH18	7314150190157	100	94
SBS19-TH19	7314150190164	1	94
SBS19-TH21	7314150190256	100	94
SBS19-TH22	7314150190188	1	94
SBS19-TH24	7314150190195	1	94
SBS19-TH75	7314150190201	1	94
SBS19-THR	7314150190218	50	93
SBS20-11*	7314153009159	1	43
SBS20-12*	7314153009166	1	43
SBS20-13*	7314153009173	1	43
SBS20-14*	7314153009180	1	43
SBS20-15*	7314153009197	1	43
SBS20-16	7314153009203	1	43
SBS20-18*	7314153009227	1	43
SBS20-20*	7314153009241	1	43
SBS20-21*	7314153009258	1	43
SBS20-22*	7314153009265	1	43
SBS20-7*	7314153009111	1	43



SBS20-8*	7314153009128	1	43
SBS20-9*	7314153009135	1	43
SBS39MH	7314150557615	24	66
SBSL25	7314153015853	5	66
SBSL25L	7314150557479	10	66
SC127	7314150121984	10	566
SC127S	7314150121991	10	566
SC127V	7314150121847	5	490
SC140	7314150122004	10	566
SC140C	7314150122011	10	566
SC150NG	7314150122028	10	566
SC150NGV	7314150121854	5	490
SC2RM-13-17	7314150265350	10	107
SC2RM-15-17	7314150265367	10	107
SC2RM-19-22	7314150181384	10	107
SC2RM-27-30	7314150265343	1	107
SC335M-17	7314150344314	1	54
SC335M-19	7314150344321	1	54
SC335M-22	7314150344338	1	54
SC335M-24	7314150344345	1	54
SC335M-32	7314150344376	1	54
SC335M-36	7314150344383	1	54
SC335M-41	7314150344390	1	54
SC335M-46	7314150344406	1	54
SCB140	7314150297351	10	565
SCB140G	7314150297368	10	565
SCRAPER-SET2	7311518228613	1	536
SE-15-24	7311518029838	5	618
SE-15-30	7311518029821	5	618
SE-15-30-23	7311518029845	5	618
SE-15-32	7311518249168	5	618
SE-15-36	7311518141202	5	618
SE-15-36-23	7311518258276	5	618
SE-16-21	7311518029807	5	618
SE-16-21-23	7311518273934	5	618
SH-407	7314150389827	1	582
SH-427-700	7314150349074	10	582
SH-428-700	7314150349081	10	582
SH-485W	7314150358021	1	580
SH-485W-PLATES	7314150358038	1	580
SH-486-493-495	7314150349098	10	582
SH-486F493F495F	7314150349104	10	582
SH-486W	7314150358014	1	581
SH-488-2000	7314150346912	10	582
SH-488-34	7314150349036	10	582
SH-488-56	7314150349043	10	582
SH-488F-2000	7314150346950	10	582
SH-488F-34	7314150349050	1	582
SH-488F-56	7314150349067	1	582
SH-491-34	7314150374298	12	582
SH-491-56	7314150374304	12	582
SH-FCP-860	7311518324421	1	587
SH-FCS-810	7311518140540	1	587
SH-FCS-860	7311518140557	1	587
SH-FGS-1.8-810	7311518327828	1	587
SH-FGS-600	7311518140649	1	587
SH-FGS-700	7311518140656	12	587
SH-FGS-800	7311518140663	1	587
SH-HFGPS-400FG	7311518282301	1	587
SH-HGPS-360	7311518140618	12	587
SH-HGPS-380	7311518140625	1	587
SH-HGPS-400	7311518207618	1	587
SH-HUS-380	7311518140502	1	587
SH-HUS-500	7311518140519	1	587
SH-HUS-650	7311518140526	1	587
SH-MCS-800	7311518140595	1	587
SH-MES-900	7311518140601	12	587
SH-MES-900FG	7311518282318	12	587
SH-MES-F-900	7311518141554	12	587
SH-PAGS-900	7311518327866	1	587
SH-PAGS-900FG	7311518326944	1	587
SH-SUS-800	7311518140809	12	587
SHARP-INS	7314150197897	100	554
SHARP-X	7311518264895	10	622
SHARP-X-DISP	7311518264901	1	622
SL24	7314150128389	30	66
SL25	7314153013422	20	65
SL25AF	7314150180141	20	67
SL25L	7314150256570	10	66
SL34	7314150409181	6	72
SL65	7314150444137	6	67
SL91*	7314150444151	4	65
SLX 17	7314153015785	1	79
SLX 17AF	7314150137558	1	79
SLX17-CASE	7314150321254	1	107
SLX20	7314150548989	2	99
SP120	7314150312474	1	79
SP120XL	7314150313594	1	99
SPAR-CASE-A4	7314150263523	1	107



SPAR-CASE-A6	7314150263547	1	107
SPAR-CASE-A7	7314150263554	1	107
SQZ-MINI	7314150186280	24	569
SQZ-MINI-BLADE	7314150190348	1	569
SQZ150003	7314153013477	6	567
SQZ150003-HSBL*	7314153015389	6	568
SR1000-E	7314150302918	20	532
SR1000-MM	7314150302857	20	532
SR150-E	7314150302864	12	532
SR150-MM	7314150302819	12	532
SR200-E	7314150302871	12	532
SR200-MM	7314150302826	12	532
SR300-E	7314150302888	12	532
SR300-MM	7314150302833	12	532
SR600-E	7314150302901	20	532
SR600-MM	7314150302840	20	532
SS001-100	7314150404384	1	514
SS001-150	7314150404377	1	514
SS001-200	7314150404391	1	514
SS001-250	7314150404407	1	514
SS001-300	7314150404414	1	514
SS001-375	7314150404421	1	514
SS001-450	7314150404438	1	514
SS001-600	7314150404445	1	514
SS002-10	7314150404483	1	514
SS002-11	7314150404490	1	514
SS002-12	7314150404506	1	514
SS002-13	7314150404513	1	514
SS002-14	7314150404520	1	514
SS002-15	7314150404537	1	514
SS002-16	7314150404551	1	514
SS002-17	7314150404568	1	514
SS002-19	7314150404575	1	514
SS002-21	7314150404582	1	514
SS002-22	7314150404599	1	514
SS002-24	7314150404605	1	514
SS002-27	7314150404612	1	514
SS002-32	7314150404629	1	514
SS002-6	7314150404469	1	514
SS002-6-2	7314150407903	1	514
SS002-7	7314150445790	1	514
SS002-8	7314150404476	1	514
SS002-9-2	7314150407910	1	514
SS003-10	7314150404643	1	514
SS003-11	7314150404650	1	514
SS003-12	7314150404667	1	514
SS003-14	7314150404681	1	514
SS003-16	7314150404704	1	514
SS003-18	7314150404711	1	514
SS003-20	7314150404728	1	514
SS003-22	7314150404735	1	514
SS003-24	7314150404742	1	514
SS003-25	7314150404759	1	514
SS003-26	7314150404766	1	514
SS003-28	7314150404773	1	514
SS003-30	7314150404780	1	514
SS003-8	7314150404636	1	514
SS011-0507*	7314150404797	1	514
SS011-0607*	7314150404803	1	514
SS011-0809*	7314150404810	1	514
SS011-0810*	7314150404827	1	514
SS011-0911*	7314150404834	1	515
SS011-1012*	7314150404858	1	515
SS011-11-3*	7314150419142	1	515
SS011-1214*	7314150404865	1	515
SS011-1417*	7314150404872	1	515
SS011-1618*	7314150404889	1	515
SS011-1719*	7314150404896	1	515
SS011-1722*	7314150404902	1	515
SS011-2224*	7314150404919	1	515
SS011-2427*	7314150404926	1	515
SS011-2430*	7314150404940	1	515
SS011-3032*	7314150404957	1	515
SS011-9-3*	7314150419135	1	515
SS210-10	7314150405343	1	515
SS210-11	7314150405350	1	515
SS210-12	7314150405367	1	515
SS210-13	7314150405374	1	515
SS210-14	7314150405381	1	515
SS210-4	7314150405268	1	515
SS210-4.5	7314150405275	1	515
SS210-5	7314150405282	1	515
SS210-5.5	7314150405299	1	515
SS210-6	7314150405305	1	515
SS210-7	7314150405312	1	515
SS210-8	7314150405329	1	515
SS210-9	7314150405336	1	515
SS220-10	7314150404995	1	515
SS220-11	7314150405008	1	515



SS220-12	7314150405022	1	515
SS220-13	7314150405039	1	515
SS220-14	7314150405053	1	515
SS220-15	7314150405060	1	515
SS220-16	7314150405077	1	515
SS220-17	7314150405084	1	515
SS220-18	7314150405091	1	515
SS220-19	7314150405114	1	515
SS220-20	7314150405121	1	515
SS220-21	7314150405138	1	515
SS220-22	7314150405145	1	515
SS220-23	7314150405152	1	515
SS220-24	7314150405176	1	515
SS220-25	7314150405183	1	515
SS220-26	7314150405190	1	515
SS220-27	7314150405206	1	515
SS220-28	7314150405213	1	515
SS220-29	7314150405220	1	515
SS220-30	7314150405237	1	515
SS220-31	7314150405244	1	515
SS220-32	7314150405251	1	515
SS220-8	7314150404964	1	515
SS220-9	7314150404988	1	515
SS224-17	7314150405398	1	515
SS224-19	7314150405404	1	515
SS224-22	7314150405411	1	515
SS224-24	7314150405428	1	515
SS224-27	7314150405435	1	515
SS224-30	7314150405442	1	515
SS224-32	7314150405459	1	515
SS224-34	7314150405466	1	515
SS224-36	7314150405473	1	515
SS224-41	7314150405480	1	515
SS224-46	7314150405497	1	515
SS224-50	7314150405503	1	515
SS224-55	7314150405510	1	515
SS224-60	7314150405527	1	515
SS224-65	7314150405534	1	515
SS234-16-100	7314150405572	1	515
SS234-16-200	7314150405589	1	515
SS234-16-250	7314150405602	1	515
SS234-24-100	7314150405619	1	515
SS234-24-200	7314150405626	1	515
SS234-24-250	7314150405633	1	515
SS236-08-80	7314150405718	1	515
SS236-16-80	7314150405701	1	515
SS236-24-110	7314150405725	1	515
SS238-08-250	7314150405657	1	516
SS238-16-250	7314150405640	1	516
SS238-24-350	7314150405664	1	516
SS242-08-200	7314150405558	1	516
SS242-16-245	7314150405541	1	516
SS242-24-320	7314150405565	1	516
SS243-08	7314150405688	1	516
SS243-16	7314150405671	1	516
SS243-24	7314150405695	1	516
SS324-1.5*	7314150405732	1	517
SS324-10*	7314150405824	1	517
SS324-2*	7314150405749	1	517
SS324-2.5*	7314150405756	1	517
SS324-3*	7314150405763	1	517
SS324-4*	7314150405770	1	517
SS324-5*	7314150405787	1	517
SS324-6*	7314150405794	1	517
SS324-8*	7314150405817	1	517
SS325-10*	7314150405886	1	517
SS325-12*	7314150405879	1	517
SS325-2.5*	7314150405909	1	517
SS325-3*	7314150405862	1	517
SS325-3.5*	7314150405923	1	517
SS325-4*	7314150405848	1	517
SS325-4.5*	7314150405930	1	517
SS325-5*	7314150405893	1	517
SS325-6*	7314150405855	1	517
SS325-7*	7314150405916	1	517
SS325-8*	7314150405831	1	517
SS400-160	7314150405978	1	518
SS400-180	7314150405985	1	518
SS400-200	7314150405992	1	518
SS402-160	7314150406005	1	518
SS402-200	7314150406012	1	518
SS406-160	7314150406029	1	518
SS406-200	7314150406036	1	518
SS410-250	7314150406043	1	518
SS410-300	7314150406050	1	518
SS412-200	7314150406067	1	518
SS415-225	7314150406074	1	518
SS502-1000-FB	7314150406081	1	518
SS502-1500-FB	7314150406098	1	518

* Until stocks last



SS502-2000-FB



SS502-2000-FB	7314150406104	1	518
SS502-2500-FB	7314150406111	1	518
SS502-3000-FB*	7314150406128	1	518
SS502-3600-FB	7314150406135	1	518
SS506-1100-FB	7314150406197	1	518
SS506-200-FB	7314150406142	1	518
SS506-300-FB	7314150406159	1	518
SS506-500-FB	7314150406166	1	518
SS506-700-FB	7314150406173	1	518
SS506-900-FB	7314150406180	1	518
SS603-15-500	7314150406203	1	518
SS603-19-500	7314150406210	1	518
SS603-20-500	7314150406227	1	518
SS603-23-500	7314150406234	1	518
SS603-23-800	7314150406258	1	518
SS603-25-600	7314150406241	1	518
SS603-30-1000	7314150406265	1	518
SS610-16-160	7314150406272	1	518
SS610-18-200	7314150406289	1	518
SS610-24-300	7314150406296	1	518
SS610-25-400	7314150406302	1	518
SS610-30-500	7314150406319	1	518
SUP-20-LAM	7311518258351	4	551
SUS-2.0-800	7311518123451	4	586
SW65	7314150442898	6	67
SW79	7314150442904	4	65
SW91*	7314150442942	4	65
TAH08-10	7314150305087	1	463
TAH08-11	7314150305094	1	463
TAH08-12	7314150305100	1	463
TAH08-13	7314150305117	1	463
TAH08-5.5	7314150305032	1	463
TAH08-6	7314150305049	1	463
TAH08-7	7314150305056	1	463
TAH08-8	7314150305063	1	463
TAH08-9	7314150305070	1	463
TAH08-H3	7314150305124	1	464
TAH08-H4	7314150305131	1	464
TAH08-H5	7314150305148	1	464
TAH08-H6	7314150305155	1	464
TAH08-H8	7314150305162	1	464
TAH08-PH1	7314150305179	1	464
TAH08-PH2	7314150305186	1	464
TAH08-PH3	7314150305193	1	464
TAH08-T10	7314150305223	1	464
TAH08-T15	7314150305230	1	464
TAH08-T20	7314150305247	1	464
TAH08-T25	7314150305254	1	464
TAH08-T27	7314150305261	1	464
TAH08-T30	7314150305278	1	464
TAH08-T40	7314150305285	1	464
TAH08-T8	7314150305209	1	464
TAH08-T9	7314150305216	1	464
TAH1-100-06-2-4	7314150307531	1	472
TAH1-110-08-1-2*	7314150437825	1	472
TAH1-143-12-1-2	7314150307548	1	472
TAH1-160-08-1-2*	7314150437818	1	472
TAH1-170-08-1-2*	7314150437801	1	472
TAH1-210-06-2-2	7314150307555	1	472
TAH1-210-08-1-2*	7314150437795	1	472
TAH1-230-06-2-2	7314150307562	1	472
TAH1-230-08-1-2*	7314150437788	1	472
TAH111M-10	7314150308538	1	461
TAH111M-11	7314150308545	1	461
TAH111M-12	7314150308552	1	461
TAH111M-13	7314150308569	1	461
TAH111M-14	7314150308576	1	461
TAH111M-15	7314150308583	1	461
TAH111M-16	7314150308590	1	461
TAH111M-17	7314150308606	1	461
TAH111M-18	7314150308613	1	461
TAH111M-19	7314150308620	1	461
TAH111M-20	7314150308637	1	461
TAH111M-21	7314150308644	1	461
TAH111M-22	7314150308651	1	461
TAH111M-23	7314150308668	1	461
TAH111M-24	7314150308675	1	461
TAH111M-25	7314150399611	1	461
TAH111M-27	7314150308682	1	461
TAH111M-30	7314150308699	1	461
TAH111M-32	7314150308705	1	461
TAH111M-34	7314150308712	1	461
TAH111M-36	7314150308729	1	461
TAH111M-41	7314150308736	1	461
TAH111M-46	7314150308743	1	461
TAH111M-50	7314150308750	1	461
TAH111M-55	7314150411573	1	461
TAH111M-6	7314150308491	1	461
TAH111M-7	7314150308507	1	461



TAH111M-8	7314150308514	1	461
TAH111M-9	7314150308521	1	461
TAH111Z-1*	7314150343362	1	461
TAH111Z-1.1/16*	7314150343379	1	461
TAH111Z-1.1/2*	7314150431830	1	461
TAH111Z-1.1/4*	7314150343386	1	461
TAH111Z-1.1/8*	7314150343393	1	461
TAH111Z-1.11/16*	7314150431854	1	461
TAH111Z-1.13/16*	7314150431878	1	461
TAH111Z-1.3/4*	7314150431861	1	461
TAH111Z-1.3/8*	7314150431816	1	461
TAH111Z-1.5/16*	7314150343409	1	461
TAH111Z-1.5/8*	7314150431847	1	461
TAH111Z-1.7/16*	7314150431823	1	461
TAH111Z-1.7/8*	7314150431885	1	461
TAH111Z-1/2*	7314150343461	1	461
TAH111Z-11/16*	7314150431852	1	461
TAH111Z-13/16*	7314150343539	1	461
TAH111Z-15/16*	7314150343546	1	461
TAH111Z-2*	7314150431898	1	461
TAH111Z-2.1/4*	7314150431915	1	461
TAH111Z-2.3/4*	7314150431946	1	461
TAH111Z-2.3/8*	7314150413959	1	461
TAH111Z-2.5/8*	7314150431939	1	461
TAH111Z-2.7/8*	7314150431953	1	461
TAH111Z-3*	7314150431960	1	461
TAH111Z-3/8*	7314150343560	1	461
TAH111Z-5/16*	7314150343591	1	461
TAH111Z-5/8*	7314150343607	1	461
TAH111Z-7/8*	7314150343621	1	461
TAH111Z-9/16*	7314150343638	1	461
TAH1150-1/2H/P	7314150307760	1	476
TAH1177-SCRIBE	7314150307777	1	476
TAH140	7314150344475	1	463
TAH141	7314150339433	1	463
TAH1410	7314150344543	1	462
TAH142	7314150339440	1	463
TAH1420	7314150344550	1	462
TAH143	7314150344482	1	463
TAH1544	7314150307746	1	476
TAH16-H10	7314150306176	1	465
TAH16-H12	7314150306183	1	465
TAH16-H14	7314150306190	1	465
TAH16-H17	7314150306206	1	465
TAH16-H19	7314150306213	1	465
TAH16-H4	7314150306121	1	465
TAH16-H5	7314150306138	1	465
TAH16-H6	7314150306145	1	465
TAH16-H7	7314150306152	1	465
TAH16-H8	7314150306169	1	465
TAH16-T30	7314150306220	1	465
TAH16-T40	7314150306237	1	465
TAH16-T45*	7314150306244	1	465
TAH16-T50	7314150306251	1	465
TAH16-T55	7314150306268	1	465
TAH16-T60	7314150306275	1	465
TAH16B-1	7314150306077	1	465
TAH16B-1.1/16	7314150306084	1	465
TAH16B-1.1/4	7314150306107	1	465
TAH16B-1.1/8	7314150306114	1	465
TAH16B-1/2	7314150305995	1	465
TAH16B-10	7314150305629	1	464
TAH16B-11	7314150305636	1	464
TAH16B-11/16	7314150306022	1	465
TAH16B-12	7314150305643	1	464
TAH16B-13	7314150305650	1	464
TAH16B-13/16	7314150306046	1	465
TAH16B-14	7314150305667	1	464
TAH16B-15	7314150305674	1	464
TAH16B-15/16*	7314150306060	1	465
TAH16B-16	7314150305698	1	464
TAH16B-17	7314150305704	1	464
TAH16B-18	7314150305711	1	464
TAH16B-19	7314150305728	1	464
TAH16B-21	7314150305735	1	464
TAH16B-22	7314150305742	1	464
TAH16B-24	7314150305759	1	464
TAH16B-25	7314150305766	1	464
TAH16B-27	7314150305773	1	464
TAH16B-3/4	7314150306039	1	465
TAH16B-30	7314150305780	1	464
TAH16B-32	7314150305797	1	464
TAH16B-5/8	7314150306015	1	465
TAH16B-7/8*	7314150306053	1	465
TAH16B-8*	7314150305612	1	464
TAH16B-9/16	7314150306008	1	465
TAH16BM22	7314150422357	1	466
TAH16BZ/1*	7314150422340	1	466
TAH16H-1/2	7314150306329	1	465

TAH16H-1/4	7314150306282	1	465
TAH16H-3/8	7314150306305	1	465
TAH16H-5/16	7314150306299	1	465
TAH16H-5/8	7314150306343	1	465
TAH16H-7/16	7314150306312	1	465
TAH16H-9/16	7314150306336	1	465
TAH1949M-10-11*	7314150308866	1	462
TAH1949M-12-14*	7314150308873	1	462
TAH1949M-14-17*	7314150308880	1	462
TAH1949M-19-22*	7314150308897	1	462
TAH1949M-24-27*	7314150308903	1	462
TAH1949M-8-9*	7314150308859	1	462
TAH1995M-10*	7314150432219	1	469
TAH1995M-12*	7314150432226	1	469
TAH1995M-8*	7314150432202	1	469
TAH1995Z-1/2*	7314150415007	1	469
TAH1RM-10	7314150414338	1	461
TAH1RM-11	7314150424306	1	461
TAH1RM-12	7314150424313	1	461
TAH1RM-13	7314150414345	1	461
TAH1RM-14	7314150424320	1	461
TAH1RM-15	7314150424337	1	461
TAH1RM-16	7314150414352	1	461
TAH1RM-17	7314150352210	1	461
TAH1RM-18	7314150414369	1	461
TAH1RM-19	7314150352227	1	461
TAH1RM-21	7314150424344	1	461
TAH1RM-22	7314150424351	1	461
TAH1RM-24	7314150352234	1	461
TAH1RM-27	7314150424368	1	461
TAH1RM-30	7314150352241	1	461
TAH1RM-32	7314150424375	1	461
TAH1RM-6	7314150424269	1	461
TAH1RM-7	7314150424276	1	461
TAH1RM-8	7314150424283	1	461
TAH1RM-9	7314150424290	1	461
TAH2047-0.8-4	7314150308088	1	469
TAH2047PR-1-2	7314150308095	1	469
TAH208*	7314150537112	1	472
TAH2101G-125	7314150344581	1	469
TAH2101G-125C*	7314150344598	1	469
TAH2101G-140	7314150307869	1	469
TAH2101G-140C*	7314150344611	1	469
TAH2101G-160	7314150307876	1	469
TAH2101G-160C*	7314150344635	1	469
TAH2101G-180	7314150345106	1	469
TAH2101G-180C*	7314150344666	1	469
TAH21HDG-200	7314150345649	1	470
TAH21HDG-200C	7314150345656	1	470
TAH2223G-150	7314150411597	1	470
TAH225-PLUS	7314150319978	1	472
TAH2339-250	7314150536320	1	471
TAH2427G-200	7314150307883	1	470
TAH2430G-160	7314150413942	1	470
TAH2430G-200	7314150307906	1	470
TAH2484-30	7314150307968	1	475
TAH2487	7314150320028	1	477
TAH24B-27	7314150309306	1	466
TAH24B-30	7314150309313	1	466
TAH24B-32	7314150309320	1	466
TAH24B-36	7314150309337	1	466
TAH24B-38	7314150309344	1	466
TAH24B-41	7314150309351	1	466
TAH24B-46	7314150309368	1	466
TAH24B-50	7314150309375	1	466
TAH2509	7314150307753	1	477
TAH2535F2	7314150307784	1	477
TAH2628G-160	7314150307913	1	470
TAH2628G-180	7314150307920	1	470
TAH2628G-200*	7314150432363	1	470
TAH2633/S4	7314150415014	1	477
TAH2800-150	7314150519330	1	470
TAH2800-180	7314150424559	1	470
TAH2820EF2	7314150307708	1	473
TAH2855	7314150307937	1	471
TAH2900-180	7314150424566	1	470
TAH2951-250	7314150432400	1	471
TAH2953-140	7314150415731	1	471
TAH2953-300	7314150415748	1	471
TAH2958-200	7314150320219	1	471
TAH2958-250	7314150307944	1	471
TAH2970G-200*	7314150343331	1	470
TAH29M-10	7314150414413	1	462
TAH29M-11*	7314150414420	1	462
TAH29M-12*	7314150424382	1	462
TAH29M-13	7314150414437	1	462
TAH29M-14*	7314150424399	1	462
TAH29M-15*	7314150424405	1	462
TAH29M-16*	7314150424412	1	462

* Until stocks last

TAH29M-17*	7314150414444	1	462
TAH29M-18*	7314150424429	1	462
TAH29M-19*	7314150424436	1	462
TAH29M-20*	7314150424443	1	462
TAH29M-21*	7314150414451	1	462
TAH29M-22*	7314150424450	1	462
TAH29M-23*	7314150424467	1	462
TAH29M-24*	7314150424474	1	462
TAH29M-25*	7314150424481	1	462
TAH29M-26*	7314150424498	1	462
TAH29M-27*	7314150424504	1	462
TAH29M-28*	7314150424511	1	462
TAH29M-29*	7314150424528	1	462
TAH29M-30*	7314150424535	1	462
TAH29M-32*	7314150424542	1	462
TAH29M-6*	7314150414376	1	462
TAH29M-7	7314150414383	1	462
TAH29M-8	7314150414390	1	462
TAH29M-9*	7314150414406	1	462
TAH2M-10-11*	7314150427772	1	461
TAH2M-12-13*	7314150427789	1	461
TAH2M-14-15*	7314150427796	1	461
TAH2M-16-17*	7314150427802	1	461
TAH2M-18-19*	7314150427819	1	461
TAH2M-6-7*	7314150427758	1	461
TAH2M-8-9*	7314150427765	1	461
TAH302-35*	7314150482924	1	463
TAH317	7314150319985	1	472
TAH317-40*	7314150482887	1	463
TAH320	7314150319992	1	471
TAH325	7314150320004	1	471
TAH3625PU-50	7314150307579	1	473
TAH3625S-28*	7314150500727	1	473
TAH3625W-35	7314150307609	1	473
TAH3640-250-C	7314150307975	1	475
TAH3681-11	7314150415038	1	475
TAH3681-16	7314150415045	1	475
TAH3681-20*	7314150415052	1	475
TAH3683	7314150352258	1	475
TAH3734BM-10	7314150308057	1	474
TAH3734BM-2	7314150343348	1	474
TAH3734BM-3	7314150307982	1	474
TAH3734BM-4	7314150308019	1	474
TAH3734BM-5	7314150308026	1	474
TAH3734BM-6	7314150308033	1	474
TAH3734BM-8	7314150308040	1	474
TAH3739-300*	7314150373925	1	475
TAH3755BM-4	7314150308064	1	475
TAH380-10	7314150307845	1	463
TAH380-14	7314150320172	1	463
TAH380-18	7314150307852	1	463
TAH380-24	7314150343317	1	463
TAH396-JT	7314150373932	1	471
TAH401-16*	7314150482948	1	463
TAH401-28*	7314150482962	1	463
TAH402-35*	7314150482900	1	463
TAH4205H-80-160*	7314150411610	1	477
TAH466-250	7314150307791	1	475
TAH479-16	7314150307586	1	473
TAH479-32	7314150307593	1	473
TAH481-300	7314150307616	1	474
TAH484-1000	7314150373918	1	474
TAH484-1500	7314150307623	1	474
TAH484-2000	7314150319916	1	474
TAH485	7314150459902	1	474
TAH486F-700	7314150370658	1	474
TAH487-5200	7314150307630	1	474
TAH489-1100	7314150307647	1	474
TAH489-1800	7314150343294	1	474
TAH489-2700	7314150319923	1	474
TAH489-3600	7314150307654	1	474
TAH489-4500	7314150427567	1	474
TAH489-5400	7314150319930	1	474
TAH490-1100*	7314150427475	1	474
TAH52	7314150339730	1	473
TAH529S-20-XL*	7314150482825	1	473
TAH6950	7314150309054	1	464
TAH6956-1	7314150309061	1	464
TAH6958B-1	7314150309078	1	463
TAH6960	7314150305315	1	464
TAH6961	7314150305322	1	464
TAH6962	7314150305339	1	464
TAH6962L	7314150305346	1	464
TAH6966	7314150305353	1	464
TAH6M-10-11	7314150370665	1	462
TAH6M-12-13	7314150370672	1	462
TAH6M-14-15	7314150400393	1	462
TAH6M-16-17	7314150400409	1	462
TAH6M-17-19	7314150370689	1	462



TAH6M-18-19



TAH6M-18-19	7314150400416	1	462
TAH6M-20-22	7314150400423	1	462
TAH6M-24-27	7314150400430	1	462
TAH6M-30-32	7314150400447	1	462
TAH6M-6-7	7314150427741	1	462
TAH6M-8-9	7314150400386	1	462
TAH700-1.5-50	7314150432301	1	468
TAH700-1.8-50	7314150432318	1	468
TAH700-2.5-50	7314150432325	1	468
TAH700-3-100	7314150432332	1	468
TAH701-0-50	7314150432349	1	468
TAH701-00-50	7314150432356	1	468
TAH703-10-50	7314150432288	1	468
TAH703-15-75	7314150432295	1	468
TAH703-6-50	7314150432240	1	468
TAH703-7-50	7314150432257	1	468
TAH703-8-50	7314150432264	1	468
TAH703-9-50	7314150432271	1	468
TAH73R-100	7314150503810	1	476
TAH73R-200	7314150503834	1	476
TAH73R-300	7314150503858	1	476
TAH7444SG-M-36	7314150308934	1	462
TAH7444SG-M-41	7314150308941	1	462
TAH7444SG-M-46	7314150308958	1	462
TAH7444SG-M-50	7314150308965	1	462
TAH7444SG-M-55	7314150308972	1	462
TAH7452-2*	7314150302543	1	477
TAH7465-15*	7314150482849	1	476
TAH74R-1500	7314150543144	1	477
TAH74W9-100	7314150519354	1	476
TAH7809M-10-140*	7314150501175	1	465
TAH7809M-8-120*	7314150501199	1	465
TAH7809XZN-10	7314150552351	1	466
TAH7809XZN-12	7314150552375	1	466
TAH7809XZN-14	7314150552399	1	466
TAH7809XZN-16	7314150552412	1	466
TAH7809XZN-18	7314150552436	1	466
TAH7809XZN-6	7314150552313	1	466
TAH7809XZN-8	7314150552337	1	466
TAH782-U	7314150339747	1	473
TAH7852-1*	7314150302550	1	477
TAH8069	7314150383603	1	461
TAH8069C*	7314150383610	1	461
TAH8070	7314150347025	1	461
TAH8070C*	7314150383627	1	461
TAH8071	7314150347032	1	461
TAH8071C*	7314150383634	1	461
TAH8072	7314150307487	1	461
TAH8072C*	7314150383641	1	461
TAH8073	7314150319831	1	461
TAH8073C*	7314150383658	1	461
TAH8074	7314150319848	1	461
TAH8074C*	7314150383665	1	461
TAH8075	7314150307500	1	461
TAH8075C*	7314150383672	1	461
TAH8150-1/2	7314150309283	1	466
TAH8158B-1	7314150309290	1	465
TAH8160	7314150306367	1	465
TAH8162	7314150306374	1	465
TAH8166	7314150306381	1	465
TAH8224	7314150307951	1	471
TAH84-PODGER	7314150312221	1	461
TAH8950N/A*	7314150309382	1	466
TAH8953*	7314150309399	1	466
TAH8961	7314150309405	1	466
TAH900T-020-100	7314150552153	1	468
TAH900T-025-100	7314150552177	1	468
TAH900T-030-100	7314150552191	1	468
TAH900T-040-150	7314150552214	1	468
TAH900T-050-150	7314150552238	1	468
TAH900T-060-200	7314150552252	1	468
TAH900T-080-200	7314150552276	1	468
TAH900T-100-200	7314150552290	1	468
TAH901T-006-100	7314150551880	1	469
TAH901T-007-100	7314150551903	1	469
TAH901T-008-100	7314150551927	1	469
TAH901T-009-100	7314150551941	1	469
TAH901T-010-100	7314150551965	1	469
TAH901T-015-150	7314150551989	1	469
TAH901T-020-150	7314150552009	1	469
TAH901T-025-150	7314150552023	1	469
TAH901T-027-150	7314150552047	1	469
TAH901T-030-200	7314150552061	1	469
TAH901T-040-200	7314150552085	1	469
TAH901T-045-200	7314150552108	1	469
TAH901T-050-200	7314150552139	1	469
TAH9045-B-250	7314150411634	1	476
TAH9048-250*	7314150411627	1	476
TAH9070	7314150307517	1	460



TAH9072	7314150307524	1	460
TAHBE-8020L	7314150308101	1	467
TAHBE-8030	7314150308118	1	467
TAHBE-8040	7314150308125	1	467
TAHBE-8040S	7314150308132	1	468
TAHBE-8050S	7314150308149	1	468
TAHBE-8155	7314150308156	1	467
TAHBE-8220S	7314150308163	1	468
TAHBE-8241	7314150308217	1	467
TAHBE-8252	7314150308224	1	467
TAHBE-8255S	7314150308226	1	468
TAHBE-8257	7314150308231	1	467
TAHBE-8258	7314150308248	1	467
TAHBE-8260	7314150308255	1	467
TAHBE-8350	7314150308262	1	467
TAHBE-8602	7314150308279	1	467
TAHBE-8610	7314150308286	1	467
TAHBE-8610S	7314150308293	1	468
TAHBE-8611	7314150308309	1	467
TAHBE-8620	7314150308316	1	467
TAHBE-8620L	7314150308323	1	467
TAHBE-8620S	7314150308330	1	468
TAHBE-8623	7314150308347	1	467
TAHBE-8624	7314150308354	1	467
TAHBE-8630	7314150308361	1	467
TAHBE-8630S	7314150320233	1	468
TAHBE-8640S	7314150320240	1	468
TAHBE-8810	7314150308378	1	467
TAHBE-8820	7314150308385	1	467
TAHBE-8820SL	7314150347827	1	468
TAHBE-8830	7314150308392	1	467
TAHBE-8880	7314150432196	1	467
TAHBE-8910	7314150343713	1	468
TAHBE-8910S	7314150343799	1	468
TAHBE-8915	7314150343744	1	468
TAHBE-8915S	7314150343805	1	468
TAHBE-8920	7314150343751	1	468
TAHBE-8920S	7314150343812	1	468
TAHBE-8925	7314150343768	1	468
TAHBE-8925S	7314150343829	1	468
TAHBE-8930	7314150343775	1	468
TAHBE-8930S	7314150343836	1	468
TAHBE-9776	7314150432233	1	469
TAHBE-9777B	7314150307685	1	469
TAHBE-9787	7314150307692	1	469
TAHBE64520	7314150307821	1	477
TAHBFRL11	7314150307739	1	478
TAHBOD5400	7314150339457	1	478
TAHBOD5450	7314150339464	1	478
TAHCRW01	7314150432370	1	470
TAHCS300*	7314150411603	1	476
TAHLTS-30*	7314150432387	1	475
TAHMA421*	7314150482863	1	472
TAHMK5	7314150411580	1	462
TAHMTT151	7314150504190	1	473
TAHNS502-1000-FB	7314150482801	1	474
TAHPINRELEASER	7314150307838	1	466
TAHSC2RM-13-17	7314150339792	1	462
TAHSC2RM-15-17	7314150339785	1	462
TAHSC2RM-19-22	7314150339761	1	462
TAHSC2RM-27-30	7314150339778	1	462
TAHSCB140G	7314150308071	1	473
TAHSR300-MM	7314150415021	1	475
TAHWBB400	7314150500703	1	474
TAHWBB600	7314150440429	1	474
TAHWBB700	7314150440436	1	474
TAM12135	7314150215331	1	121
TAM12200	7314150215348	1	121
TAM12340	7314150215355	1	121
TAM1430	7314150215317	1	121
TAM38135	7314150215324	1	121
TAS14H007	7314150423187	1	117
TAS14H09	7314150423200	1	117
TAS14S007	7314150423194	1	117
TAS14S09	7314150423217	1	117
TASM14H007	7314150539444	1	117
TASM14H09	7314150539437	1	117
TASMB14H007	7314150489664	1	117
TASMB14H09	7314150489671	1	117
TAW12340	7314150274963	1	111
TAW1412M	7314150423156	1	111
TAW1430M	7314150422289	1	111
TAW14340	7314150340842	1	111
TAW24800	7314150368297	1	111
TAW34800	7314150285471	1	111
TAW38135	7314150274956	1	111
TAW38135M	7314150502295	1	111
TAW912M	7314150423163	1	111
TAW9135	7314150340859	1	111



TAW9135M	7314150502288	1	111
TAW930M	7314150422319	1	111
TAWM12340	7314150274925	1	110
TAWM1412M	7314150423149	1	110
TAWM1430*	7314150274901	1	110
TAWM1430M	7314150422265	1	110
TAWM14340	7314150340835	1	110
TAWM24800	7314150368280	1	110
TAWM34800	7314150274932	1	110
TAWM38135	7314150274918	1	110
TAWM38135M	7314150502264	1	110
TAWM912M	7314150423132	1	110
TAWM9135	7314150340828	1	110
TAWM9135M	7314150502271	1	110
TAWM930A*	7314150275724	1	111
TAWM930M	7314150422241	1	110
TAWMB14340	7314150489626	1	110
TAWMB24650	7314150490103	1	110
TAWMB24800	7314150489633	1	110
TAWMB9135M	7314150490110	1	110
TAWMB930M	7314150489640	1	110
TEA003	7314150422180	1	120
TEA010	7314150422197	1	120
TEA030A	7314150522750	1	120
TEA065	7314150472246	1	121
TEA1100	7314150423170	1	121
TEA2100	7314150465972	1	121
TEA350	7314150422210	1	121
TJS003	7314150522477	1	120
TJS010	7314150522484	1	120
TJS030	7314150522491	1	120
TL 00-SA	7314150109579	1	638
TL 00-SA-ET	7311518279219	1	642
TL 00-SA-SL	7314150115228	5	643
TL 000-SA	7314150522934	1	639
TL 00ACF	7314150522958	1	646
TL 00B-SA	7314150109555	1	638
TL 00CFR-SA	7314150115402	1	641
TL 00D-SA	7314150109562	1	638
TL 0C9-SA	7314150109586	1	639
TL 1-SA	7314150109647	1	639
TL 1-SA-SL	7314150115235	5	643
TL 124-SA	7314150110018	1	646
TL 15A	7314150522972	1	638
TL 15AGW	7314150522996	1	638
TL 15AGWHM-SA	7314150523016	1	638
TL 2-SA-SL	7314150115242	5	643
TL 242ACF	7314150523030	1	647
TL 242CFR-SA	7314150523054	1	640
TL 249 ACF	7314150115174	1	647
TL 249CFR-SA	7314150115143	1	640
TL 259 ACF	7314150115167	1	647
TL 259 CFR-SA	7314150115150	1	640
TL 259ACP	7314150465590	1	647
TL 259ASV	7314150465569	1	647
TL 259CPR-SA	7314150523078	1	641
TL 259SVR-SA	7314150523092	1	641
TL 2A ACF	7314150115457	1	647
TL 2A-SA	7314150110100	1	639
TL 2A-SA-ET	7314150523115	1	642
TL 2A-SA-SL	7314150115259	5	643
TL 2ACFR-SA	7314150115419	1	641
TL 3-SA	7314150110162	1	639
TL 3-SA-ET	7311518279356	1	642
TL 3-SA-SL	7314150115266	5	643
TL 34A-SA	7314150524068	1	640
TL 3C-SA	7314150110148	1	639
TL 3C-SA-ET	7314150523139	1	642
TL 3C-SA-SL	7314150115273	5	643
TL 4-SA-SL	7314150115280	5	643
TL 475-SA	7314150110032	1	646
TL 5-SA	7314150110247	1	639
TL 5-SA-ET	7314150523153	1	642
TL 5-SA-SL	7314150115297	5	644
TL 51S-SA	7314150110209	1	639
TL 578-SA	7314150110438	1	646
TL 582-SA	7314150110452	1	646
TL 5A-SA-SL	7314150115303	5	644
TL 5ACF	7314150115464	1	647
TL 5ACP	7314150465606	1	648
TL 5ASV	7314150465576	1	647
TL 5B-SA	7314150110223	1	640
TL 5CF-SA	7314150523177	1	641
TL 5CFR-SA	7314150115426	1	641
TL 5CPR-SA	7314150523191	1	641
TL 5SVR-SA	7314150523214	1	641
TL 6-SA	7314150523238	1	640
TL 648-SA	7314150110049	1	646
TL 649-SA	7314150110063	1	646

* Until stocks last



TL 65A-SA	7314150110278	1	640
TL 7-SA	7314150110292	1	640
TL 7-SA-ET	7314150523252	1	643
TL 7-SA-SL	7314150115310	5	644
TL 7A-SA	7314150110285	1	640
TL 7A-SA-ET	7314150523283	1	643
TL 7A-SA-SL	7314150115327	5	644
TL 7ACF	7314150115471	1	647
TL 7ACP	7314150465613	1	648
TL 7ASV	7314150465583	1	648
TL 7CFR-SA	7314150115433	1	642
TL 7CPR-SA	7314150523306	1	641
TL 7SVR-SA	7314150523320	1	642
TL AA-SA-ET	7314150523344	1	642
TL AA-SA-SL	7314150115334	5	644
TL AC-SA-SL	7314150115341	5	644
TL MM-SA-SL	7314150115365	5	644
TL SM 103-SA	7314150110773	1	645
TL SM 104-SA	7314150110780	1	644
TL SM 105-SA	7314150110797	1	645
TL SM 107-SA	7314150110810	1	645
TL SM 108-SA	7314150110827	1	645
TL SM 109-SA	7314150110834	1	645
TL SM 110-SA	7314150110841	1	645
TL SM 111-SA	7314150110858	1	645
TL SM 115-SA	7314150110896	1	646
TL SM 117-SA	7314150110919	1	646
TL SM106-SA	7314150523368	1	645
TL SM116-SA	7314150523382	1	645
TL SM116-SA-ET	7314150523405	1	642
TL SS-SA	7314150109937	1	639
TL SS-SA-SL	7314150115358	5	644
TR0325M03X-50	7314150501632	5	153
TR0636M06X-65	7314150501663	5	153
TR0650M06X-80	7314150501694	5	153
TR0860M08X-110	7314150507269	5	153
TR4.530M06X-90	7314150501755	5	153
TRX 8180	7314150112272	5	629
TSS120	7314150347063	1	118
TSS600	7314150346417	1	118
W-S-1.5	7311518140816	4	587
W-S-2.0	7311518140823	4	587
W-S-2.5	7311518140830	4	587
W-T-2.0	7311518140847	4	587
WBB1000	7314150431502	4	598
WBB1200	7314150431519	4	598
WBB1500	7314150431526	4	598
WBB400	7314150315215	10	598
WBB500	7314150315222	10	598
WBB600	7314150315239	10	598
WBB700	7314150315246	6	598
WBB800	7314150340972	6	598
WBF380	7314150315253	12	598
WBMF190	7314150315260	24	598
WBMF190IP	7314150457960	15	598
WBP-3P-6FMF	7314150453115	1	599
WBP-3P-96F	7314150453108	1	599
WBP300	7314150315161	20	598
WBP500	7314150315178	12	598
WBP625	7314150315185	12	598
WBP710	7314150315192	10	598
WBP900	7314150315208	6	598
WC-HOL	7314150333158	1	561
WPH 2-50	7314150520428	1	595
WPH 3-20	8412814125435	1	595
WPH 3-30	8412814125442	1	595
WR1	7314150167425	50	531
WR1-MM	7314150220069	50	531
WR2	7314150167432	25	531
WR2-12	7314150185627	25	531
WR2-MM	7314150220038	25	531
XLARGE	7314150437412	1	369
XXL	7314150504152	1	368



Contact Us

Argentina

SNAE Argentina SRL
A.M. de Justo 1750 3° A
C1107AFJ - Capital Federal
Buenos Aires
Tel: +54 (11) 4313-1004
Fax: +54 (11) 4893-3553

Australia

SNAE Australia
3 Cooper Street, Smithfield,
NSW 2164
Tel: +61 (0) 2 8787 5700
Fax: +61 (0) 2 9756 6130

Belgium

Branch of SNA Europe (Benelux) BV
De Kleetlaan 12A Pegasus Park
1831 DIEGEM
Tel: +32 (0)2 726 03 03
info.be@bahco.com

Chile

Comercial SNAE Chile LTDA
Av. Americo Vespucio 2760-D
Conchalí - Santiago - Chile
Tel: + 56 2 623 0203
Fax: + 56 2 623 5395

Česká republika

SNA Europe s.r.o.
Holadnská 2/4
639 00 Brno
Tel: +420 537 022 520
Fax: +420 537 022 200

Danmark

SNA Europe [Denmark] A/S
Vallensbækvej 40,
2605 Brøndby
Tel: +45 4363 0330
Fax: +45 4396 2456

Deutschland

SNA Europe [Germany]
Willettstraße 10
40822 Mettmann
Tel: +49 (0) 2104 833 83 0
Fax: +49 (0) 2104 833 83 7999

España

SNA Europe [Industries] Iberia SA
c/ Hilanderas, 1
(P.O. Box / Apdo de Correos nº 5)
C.P. 20303 Irún
Tel: +34 902 235 100 / +34 943 649 111
Fax: +34 943 649 120

Ελλάδα

SNA Europe
Λ. Βουλιαγμένης 604Γ
167 77 Ελληνικό, Αθήνα
Τηλ: +30 210 9914263
Info.gr@snaeurope.com

Export

SNA Europe
Antigua Carretera de Altube Km 5,5
P.O.Box 307
01080 VITORIA (Spain)
Tel: +34 945269711
Fax: +34 945165040

France

SNA EUROPE (France)
41 Boulevard Pierre de Coubertin
49 000 ANGERS
Tél: +33 (0) 2 41 22 98 40
Fax: +33 (0) 2 41 22 98 50

Italia

SNA EUROPE Italia S.p.A.
Via Georges Bizet, 13/15
20092 Cinisello Balsamo MI - Italia
Tel. +39 02 3024161
info.it@snaeurope.com

Қазақстан

050000, Алматы,
ул.Шевченко 1656/72г, оф.217
Тел/факс +7 727323 63 39

Nederland

SNA Europe [Benelux] BV
Vossenbeemd 113
5705 CL Helmond
Tel: +31 (0) 492 58 23 82
info.nl@bahco.com

New Zealand

SNAE New Zealand
Unit 3/25 Highbrook Drive
East Tamaki
Auckland
Tel: +64 9-273 46 50
Fax: +64-9-273-2453

Norge

SNA Europe [Norway]
Box 800
1306 Sandvika
Tel: +47 40 49 66 00
Fax: +47 67 17 56 51

Österreich

SNA Europe
Vienna, Nineteen, Mooslackengasse 17
A - 1190 Wien
Tel: +49 (0) 2104 8 33 83 0
Fax +49 (0) 2104 833 83 79 99

Polska

SNA Europe - Poland Sp. z o. o.
ul. Marynarska 15
02-674 Warszawa
Tel.: +48 (0) 22 6070510
Fax: +48 (0) 22 6070521

Portugal

SNA Europe [Industries] LDA
R. Maria Julia M. Ramos - Junqueira
4480-254 Vila Do Conde
Tel. +351 252 650 131
Fax. +351 252 650 160

Slovenská republika

SNA Europe s.r.o.
Karadžičova 8/A
821 08 Bratislava
Tel: +421 (0)2 5939 6124
Fax: +421 (0)2 5939 6217

SRBIJA

Vermax-alati doo
Ul. Drage Spasić 35
11000 Beograd
Tel: +381 11 2360 500
Tel: +381 11 2360 900
Fax: +381 11 2361 147
e-mail: office@vermax.rs

Suomi

SNA Europe Oy
PL 6580
00002 Helsinki
Finland
Tel: +358 207 433 510
Fax: +358 207 433 525

Sverige

SNA Europe Industries AB
Box 83
SE-745 22 Enköping
Tel: +46 (0) 171-47 82 00
Fax: +46 (0) 171-47 82 38

Schweiz / Suisse

SNA Europe
Willettstraße 10
40822 Mettmann
Tel: +49 (0) 2104 833 83 0
Fax: +49 (0) 2104 833 83 7999

Türkiye

SNA E Endüstriyel Mam. San. Tic. Ltd. Şti.
Girne Mah. Maltepe Küçük San. Sitesi
F Blok No:19 Maltepe
Istanbul
Tel: +90 (0) 216 367 10 21
Fax: +90 (0) 216 367 11 71

Украина

«Бахко Бисов Свенска Акциеболаг»
SNA Europe [Ukraine & Moldova]
Телефон +38 067 441 16 09
офис 555, улица Армянская, 6А
Киев, Украина

United Kingdom

SNA Europe [UK]
Moorhead Way, Bramley,
Rotherham, South Yorkshire S66 1YY
Tel: +44 (0) 1709 731731
Fax: +44 (0) 1709 731741



Warranty

For warranty info please check your local website www.bahco.com



This catalogue comprises our current product assortment. Changes in the assortment as well as change of net shapes, forms, designs and designations are made continuously. No specific information will necessarily be issued to this effect.

Illustrations and drawings have been reproduced to be as accurate as possible. For the purposes of a catalogue they may, however, differ from the products themselves, as may the technical specifications.

Indications of weight are to be understood as approximate net weights, and serve primarily to facilitate calculations of freight and postage charges.

This catalogue supersedes all previous specifications and assortment lists.

The intellectual property in this catalogue is the property of SNA Europe. Excerpts, reprints or copies of the contents may be made with our permission

2025



M-ENG-CAT-25



7 314150 564439 >



www.bahco.com