

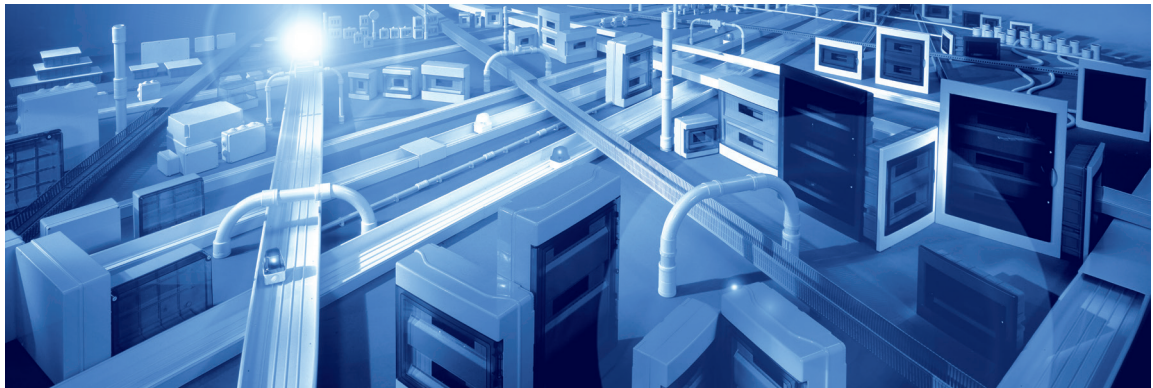

electrical installation systems



endless evolution

FAST
CATALOGUE



The Italian products

Dear Customer,

ELETTROCANALI is an Italian company which designs and manufactures trunking systems and equipments for a complete industrial, commercial or domestic electrical system.

ELETTROCANALI is proud to present its new catalogue which has been widened and enriched in the latest years also thanks to all the suggestions and the tips we have received.

ELETTROCANALI products are divided in 4 big product families. Each one easily identified by a different colour, which identifies the sections on the catalogue, for a total of over 4.000 articles: practical, functional, meeting the users expectations, tested and safe.

They are complementary, give the distributor a complete range which can fully meet the needs of low-voltage installations.

Luca Valsecchi
Marketing Manager

A yellow line graphic that starts at the top right, curves down, then left, then down again, ending in a circular shape.

Flush-mounting and wall-mounting IP40 and IP65 modular enclosures, emergency enclosures, flush-mounting and wall-mounting junction boxes, fiberglass boards.

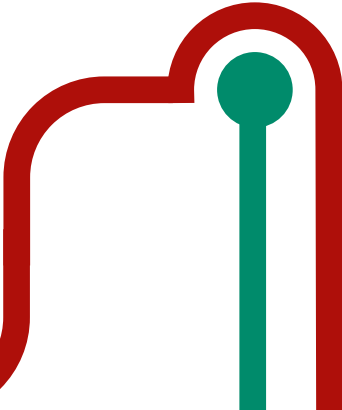
A red line graphic that starts at the top left, curves down, then right, then down again, ending in a circular shape.

Plugs and sockets EN60309, interlocked sockets, empty and assembled distribution boards DBO/ASC, control switches, safety switches.

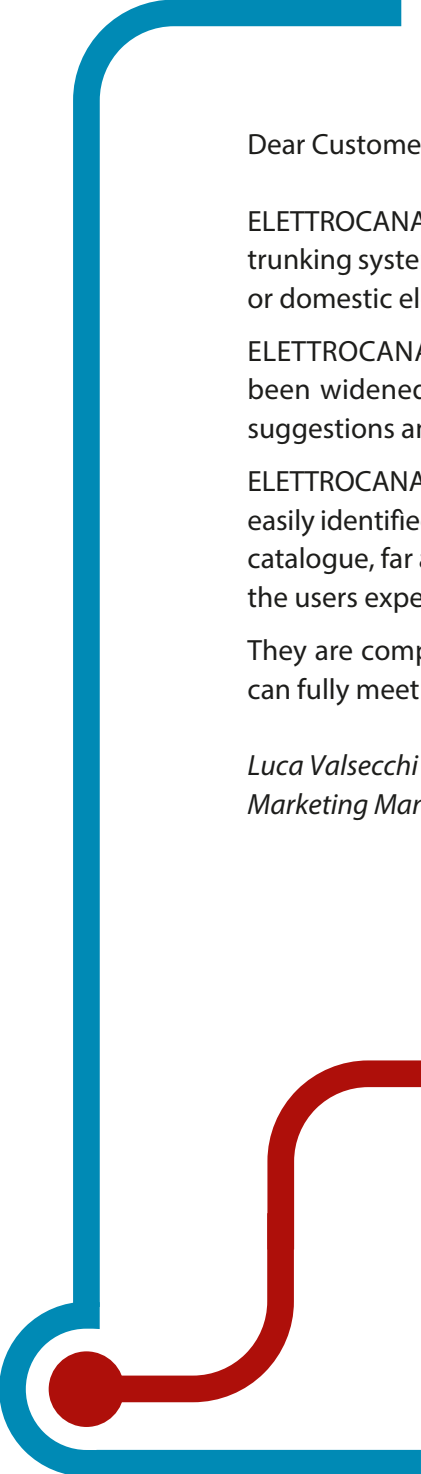
A blue line graphic that starts at the top left, curves down, then right, then down again, ending in a circular shape.

Skirting board and wall trunking systems, minitrunkings and cable trunkings, slotted trunkings, trunking systems for air conditioning.

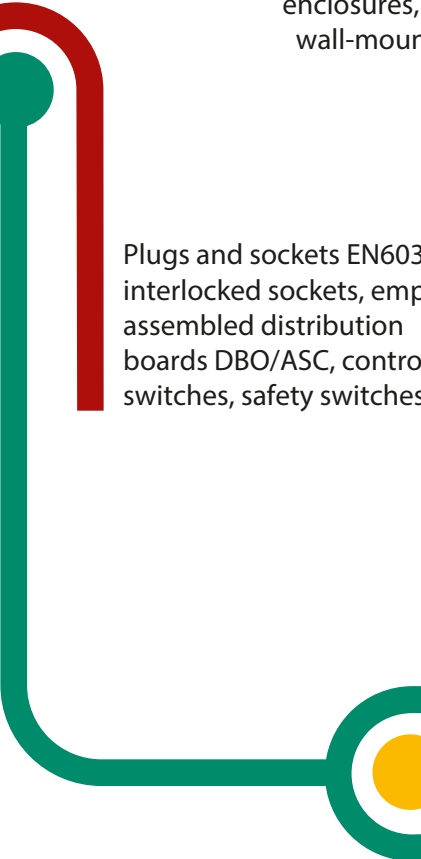
A green line graphic that starts at the top left, curves down, then right, then down again, ending in a circular shape.

Rigid and pliable conduits, flexible spiral conduits, conduit fittings, fixing systems, cable glands and brass terminals.



HEADQUARTERS, PRODUCTION FACILITIES, R&D
Via Generale C.A. Dalla Chiesa, 18 - 24020 Scanzorosciate (BG) IT
Tel. +39 035 665077/668264 - Fax +39 035 655475/6590705
info@elettrocanali.com

FROM ITALY ALL OVER THE WORLD

ELETTROCANALI SPA



NEW PRODUCTION FACILITIES 2019
Scanzorosciate (BG)



HEADQUARTERS
Scanzorosciate (BG)



BRANCH OFFICE AND PRODUCTION FACILITIES
Via Pianodardine, 16/B - 83100 Avellino (AV)
Tel. +39 0825 624128/9 - Fax +39 0825 622223
info@elettrocantali-av.com

In our 3 plants all located in Italy we design and manufacture products that are distributed in over 70 countries. Experienced technicians and skilled labor contribute to improving and increasing the product range according to the requests of customers who have always appreciated and supported us; this catalogue represents the continuous evolution of a business project born over 50 years ago, on which we have been investing in term of human resources and technology.



ELETTROCANALI FRANCE Sarl
Vie De Boussieu - Ruy-Montceau, BP 90244
38305 BOURGOIN-JALLIEU Cedex (F)
Tel. +33 (0)474 280588 - Fax +33 (0)474 280883
elettrocantali.france@elettrocantali.com



PRODUCTION FACILITIES
Via Vincenzo Pirani, 1
60131 Ancona (AN)



ELETTROCANALI CENTRO
Calle Vedra, 2
28053 Madrid (E)
Tel. +34-917 850 788
elettrocantalicentro@carvals.es

NEWS! A CONSTANTLY

MINITRUNKING SYSTEM WITH WRAP-AROUND COVER

- New wrap-around cover with functional modern design.
- Rounded cover: +30% of wiring capacity.
- Positioning edge for easily fixing accessories.
- Also available in grey black slate colour code -A.
- Adaptor boxes for 3, 4 and 6/7 modules.

Page
11

DUCT FOR AIR CONDITIONING INSTALLATION

- New dimensions 110x75 and 140x90 mm.
- Rounded cover supplied with protective film.
- The range of accessories for the change of direction permit to carry out any configuration.

Page
20

GROWING ENTERPRISE

WALL MOUNTING INCLINED BOX PLUGS



Page
29

- Plugs 16A and 32A made according to EN 60309 standard.
- IP44/67 protection degree.
- Base with M25 threaded inlet with closure cap included.
- Copper-zinc alloy with high electric conductivity for contacts.
- Plastic material free from cadmium and halogen.
- High-quality technopolymer body in grey colour.

PHOTOVOLTAIC PREWIRED CONDUITS

- New range of UV corrugated prewired H1Z2Z2-K conduits.
- Available with 2+1 or 4+1 dedicated cable section 4 mm².
- New range of rigid UV conduits 1250N - class. 4341

HALOGEN Free

Page
68

PANEL MOUNTING SWITCH

Page
37

- For mounting on our 690 series boards.
- Nominal current of 16-20-32-40 A, 2-3-4 poles.
- Padlockable knob.

TRUNKING SYSTEMS					INDUSTRIAL SYSTEMS		
1	2	3	4	5	1	2	3
<p>Minitrunkings with front-hooking cover Series MC Page 10</p>	<p>Cable trunkings with cover Series CP Page 14</p>	<p>Skirting board and wall trunking Series SIMPLY Series MAXI Page 19</p>	<p>Duct for air conditioning installation Series SPLIT Page 20</p>	<p>Slotted trunkings with cover Series A Page 21</p>	<p>Industrial straight plugs Page 26</p>	<p>Wall mounting emergency push-button Page 35</p>	<p>Empty distribution boards Page 38</p>
<p>Minitrunkings with wrap-around cover Series MCA Page 10</p>	<p>Halogen free cable trunkings with cover Series CPH Page 16</p>	<p>Accessories for skirting board and wall trunking Page 19</p>	<p>Accessories for air conditioning installation Series SPLIT Page 20</p>	<p>Slotted trunkings with cover Series S Page 21</p>	<p>Industrial straight sockets Page 27</p>	<p>Safety switches technopolymer box Page 36</p>	<p>Pre-cut distribution boards Page 38</p>
<p>Minitrunkings with wrap-around cover with rounded edges Series MC Page 11</p>	<p>60x60 Device installation trunkings with cover Series BR Page 17</p>	<p>Accessories for air conditioning installation Series SPLIT Page 20</p>	<p>Accessories for air conditioning installation Series SPLIT Page 20</p>	<p>Flexible slotted trunkings Series 234 Page 22</p>	<p>Panel mounting inclined sockets Page 28</p>	<p>Control switches technopolymer box Page 36</p>	<p>Pre-cut distribution boards Page 38</p>
<p>Self-adhesive minitrunkings with hinged cover Series MA Page 12</p>	<p>45x45 Device installation trunkings with cover Series 220 Page 18</p>			<p>Pre-cut trunkings for conduit installation Series P Page 22</p>	<p>Wall mounting inclined/straight box sockets Page 29</p>	<p>Panel mounting safety switches Page 37</p>	<p>Cabled distribution boards DBO type Page 40</p>
<p>Minitrunkings with front-hooking cover German type Page 12</p>				<p>Accessories for slotted trunkings Page 22</p>	<p>Wall mounting inclined box plugs Page 29</p>	<p>Panel mounting control switches Page 37</p>	<p>Cabled distribution boards ASC type Page 40</p>
<p>Floor cable trunkings Series CAP Page 12</p>				<p>Halogen free slotted trunkings with cover Series AH-SH Page 23</p>	<p>Interlocked horizontal sockets Page 30</p>		
				<p>Spiral wrap Series P Page 23</p>	<p>Interlocked vertical sockets Page 32</p>		
					<p>Multiplier Page 34</p>		

WALL AND FLUSH MOUNTING DISTRIBUTION ENCLOSURES				CONDUIT SYSTEMS AND ACCESSORIES			
1	2	3	4	1	2	3	4
							
Surface mounting polyester boards Page 44	IP40 Wall mounting modular enclosures with transparent door - Series 600 Page 48	IP40/IP55 Wall boxes for electrical devices MyLIFE Page 52	Flush mounting junction boxes Page 60	Rigid conduits Series TG 3321/2221 Page 64	Coupling for corrugated conduits Series GFLEX Page 70	IP67 Accessories for conduit systems Series security Page 71	Nylon cable ties Page 73
							
IP40 Wall mounting modular enclosures with transparent door - RAL9001 Series 600 Page 48	IP40 Wall mounting modular enclosures with transparent door - RAL9001 Series 600 Page 48	IP55 Waterproof electrical devices Page 53	Flush mounting 60x60 standard modular box for devices Page 61	Halogen Free rigid conduits Series TG 2342-3342 Page 64	Ground boxes Page 70	PG-Thread cable glands without lock nut Page 74	PG-Thread cable glands without lock nut Page 74
							
IP40 Wall mounting modular enclosures without door Series 610 Page 48	IP40 Wall mounting modular enclosures without door Series 610 Page 48	IP55 Cable junction boxes Series 411 Page 56	Flush mounting High internal volume boxes for modular devices Page 61	Pliable corrugated PVC conduits Series TC 3321-2221-3341 Page 65	Halogen free IP40 Accessories for conduit systems Page 70	PG-Thread cable glands with lock nut Page 74	PG-Thread cable glands with lock nut Page 74
							
IP65 Wall mounting watertight modular enclosures Series 620 Page 49	IP65 Wall mounting watertight modular enclosures Series 620 Page 49	Junction boxes with stepped glands Series 400 Page 56	Flush mounting round boxes for devices Page 61	Pliable corrugated ICTA conduits 3422 Page 66	IP40 Standard Accessories for conduit systems Page 70	Metric thread cable glands with lock nut Page 74	Metric thread cable glands with lock nut Page 74
							
IP65 Wall mounting watertight emergency modular enclosures Series 64 Page 49	IP65 Wall mounting watertight emergency modular enclosures Series 64 Page 49	Smooth sided junction boxes Series 410 Page 56	Dry lining installation boxes for modular devices Page 61	Pliable corrugated TP conduits 2232-3422-2332 Page 67	IP65 Accessories for conduit systems Page 70	Gaskets and lock nuts for cable glands Page 75	Gaskets and lock nuts for cable glands Page 75
							
IP40 Flush mounting modular enclosures Series 630 Page 51	IP40 Flush mounting modular enclosures Series 630 Page 51	Smooth sided junction boxes transparent lid Series 410 Page 57	Dry lining installation junction boxes Page 61	Conduits for solar/photovoltaic/wind plant Page 68	IP67 Accessories for conduit systems Series e@ssystem Page 71	Equipotential plates Page 75	Equipotential plates Page 75
							
IP40 Dry lining modular enclosures Series 635 Page 51	IP40 Dry lining modular enclosures Series 635 Page 51	Junction boxes with cable direct inlet Series 4xx Page 58	Alveolar board with reversible door Series 65 Page 59	Spiral flexible PVC conduits Series GFE 2311 Page 69	Nylon cable draw tape Page 72	Insulating adhesive tape Page 76	Insulating adhesive tape Page 76
							
Aluminum wall mounting junction boxes Series 485 Page 59	Aluminum wall mounting junction boxes Series 485 Page 59	Aluminum wall mounting junction boxes Series 485 Page 59	Aluminum wall mounting junction boxes Series 485 Page 59	Spiral flexible conduit-box joint Series GX Page 69	Standard and Halogen Free Conduit Clips Page 72	Transparent unipolar terminal blocks Page 76	Transparent unipolar terminal blocks Page 76
Thermoplastic lamp holder Page 76	Thermoplastic lamp holder Page 76	Thermoplastic lamp holder Page 76	Thermoplastic lamp holder Page 76	Thermoplastic lamp holder Page 76	Thermoplastic lamp holder Page 76	Thermoplastic lamp holder Page 76	Thermoplastic lamp holder Page 76

TRUNKING SYSTEMS

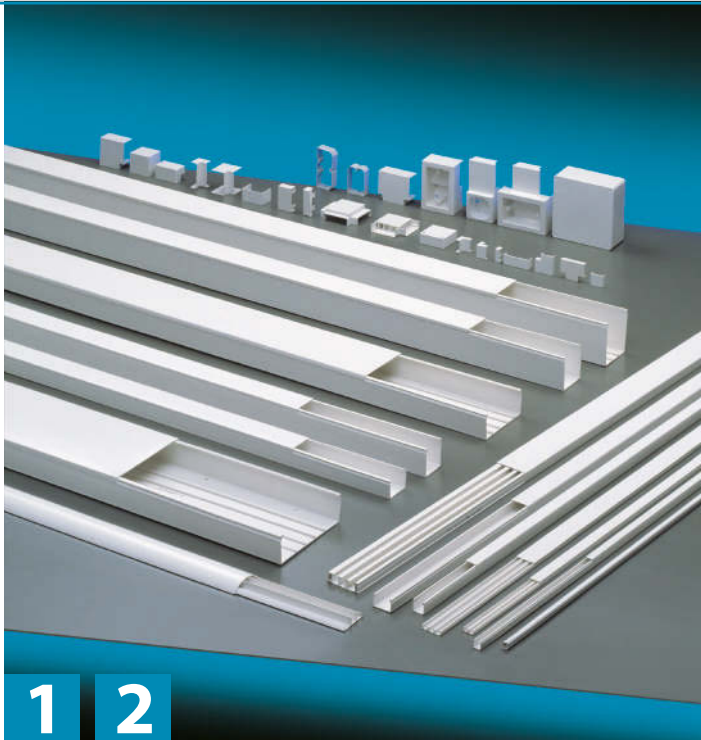

1 2

**MINITRUNKING SYSTEMS
CABLE TRUNKING SYSTEMS**



3

SKIRTING BOARD AND WALL TRUNKING SYSTEMS

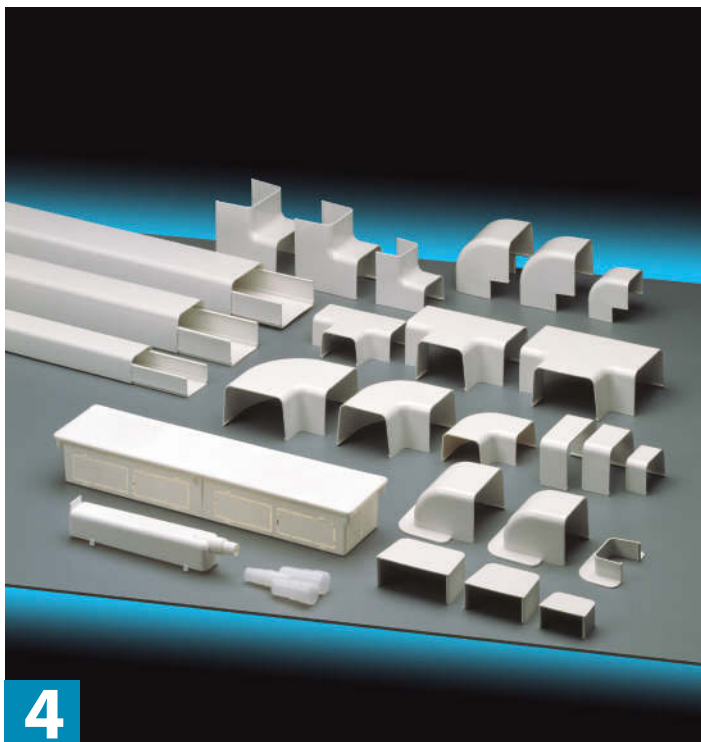

4

**TRUNKING SYSTEMS FOR AIR CONDITIONING
INSTALLATION**

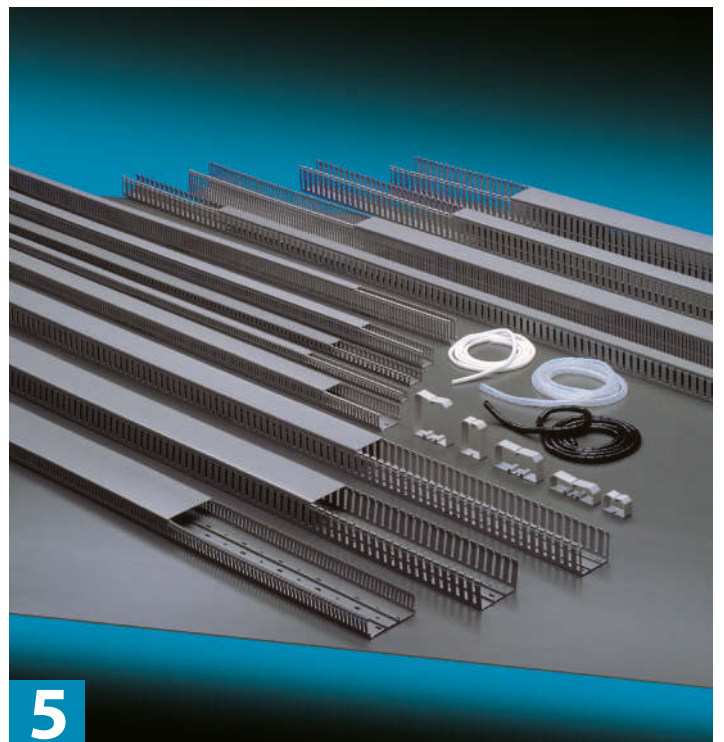

5

SLOTTED TRUNKINGS

MAIN TECHNICAL FEATURES

Externally grooved bottom for a fast fixing by glues or silicone adhesives

Wrap-around cover without sharp edges, functional modern design

In the trunkings with wrap-around cover the lid can be removed only by a proper tool

The particular form makes the most of the inner room and permits to unify the accessories

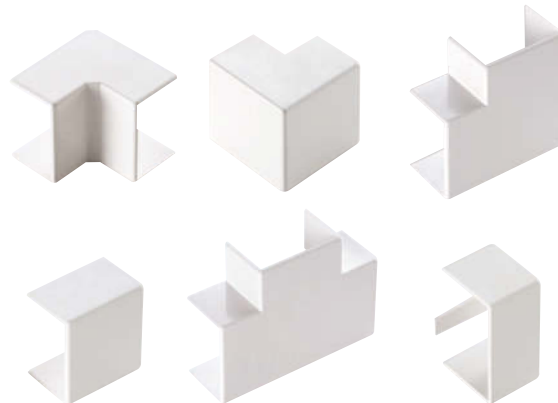

Perforated bottom for a quicker and more precise installation

The minitrunkings can have 1,2 or 3 internal compartments for any distribution need

The bottom of the wrap-around trunkings has got a spacing profile for the installation in the corner

Accessories for change of direction for any installation need

Fully made of self-extinguishing technopolymer on PVC base and available in white RAL 9001 or, on request, in grey RAL 7030 and brown RAL 8014, the minitrunkings are characterized by perfectly symmetric inner compartments; they can be easily installed on the wall, as skirting board and also in the corner, thanks to the spacing profile (in the version with wrap-around cover), which keeps the trunking distant enough from the wall, so that the cover can be set without any problem.

The wide range of minitrunkings MC and MCA with standard or wrap-around covers is composed of 23 different dimensions and types,

with an inner splitting with 1, 2 or 3 sections. The perfectly separated compartments permit to put, in the same trunking, the wires of different electric circuits: power, phone, data transmission and other, without any risk of interferences or inappropriate overlapping, according to the Standard CEI 64-8.

The derivation boxes has an appropriate grid allowing to keep the cables divided. The device boxes, equipped with a blank cover, can be also used as further junction boxes.

Some sizes of the minitrunkings system are available with or without internal separator. That is an undoubted advantage for the

renovation and the widening of complex electrical systems (power, telephone, HI-FI television, SAT) without the risk of interferences.

The several accessories for the change of direction, the derivation boxes and the device boxes allow to put together a complete and functional distribution system.

The minitrunkings MC and MCA can be combined with skirting board and wall trunking system and cable trunking system, as well as the modular enclosures manufactured in the same colour as the minitrunkings, in order to fulfill the installation and renovation needs with a compact elegant functional system.

MINITRUNKINGS WITH FRONT-HOOKING COVER - SERIES MC



ITEM	COLOUR	UM	DESCRIPTION	PACK-AGING
EC MC1517B	B	MT	dim. 15x17	100
EC MC2010B	B	MT	dim. 20x10	100
EC MC2210B-1B	B	MT	dim. 22x10	100
EC MC2210B	B	MT	dim. 22x10-2 compartments	100
EC MC2517B	B	MT	dim. 25x17	80
EC MC2525B	B	MT	dim. 25x25	100
EC MC3010-1B	B	MT	dim. 30x10	80
EC MC3010B	B	MT	dim. 30x10-2 compartments	80
EC MC4010B	B	MT	dim. 40x10	60
EC MC4017-1B	B	MT	dim. 40x17	50
EC MC4017B	B	MT	dim. 40x17-2 compartments	50
EC MC4025B	B	MT	dim. 40x25	80
EC MC5020B	B	MT	dim. 50x20	60
EC MC5020-1B	B	MT	dim. 50x20-2 compartments	60
EC MC5020-2B	B	MT	dim. 50x20-3 compartments	60
EC MC6017B	B	MT	dim. 60x17-3 compartments	70

MINITRUNKINGS WITH WRAP-AROUND COVER - SERIES MCA

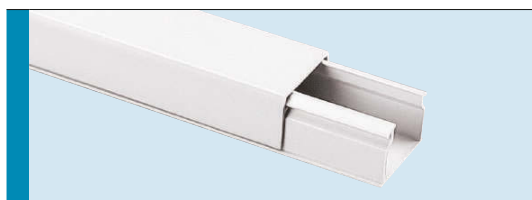

ITEM	COLOUR	UM	DESCRIPTION	PACK-AGING
EC MC1517AB	B	MT	dim. 15x17	80
EC MC2010AB	B	MT	dim. 20x10	100
EC MC2517AB	B	MT	dim. 25x17	60
EC MC2525AB	B	MT	dim. 25x25	80
EC MC3010AB	B	MT	dim. 30x10-2 compartments	80
EC MC4017AB	B	MT	dim. 40x17-2 compartments	80
EC MC4025AB	B	MT	dim. 40x25	60

ITEM	COLOUR	UM	DESCRIPTION	PACK-AGING
------	--------	----	-------------	------------

INTERNAL ANGLE FOR MINITRUNKINGS



EC AI1517B	B	PCS	dim. 15x17	2/50
EC AI2010B	B	PCS	dim. 20x10	2/50
EC AI2210B	B	PCS	dim. 22x10	2/50
EC AI2517B	B	PCS	dim. 25x17	2/50
EC AI2525B	B	PCS	dim. 25x25	2/50
EC AI3010B	B	PCS	dim. 30x10	2/50
EC AI4010B	B	PCS	dim. 40x10	2/50
EC AI4017B	B	PCS	dim. 40x17	2/50
EC AI4025B	B	PCS	dim. 40x25	2/50
EC AI6017B	B	PCS	dim. 60x17	2/50

ITEM	COLOUR	UM	DESCRIPTION	PACK-AGING
------	--------	----	-------------	------------

STRAIGHT JOINT FOR MINITRUNKINGS



EC GU1517B	B	PCS	dim. 15x17	2/50
EC GU2010B	B	PCS	dim. 20x10	2/50
EC GU2210B	B	PCS	dim. 22x10	2/50
EC GU2517B	B	PCS	dim. 25x17	2/50
EC GU2525B	B	PCS	dim. 25x25	2/50
EC GU3010B	B	PCS	dim. 30x10	2/50
EC GU4010B	B	PCS	dim. 40x10	2/50
EC GU4017B	B	PCS	dim. 40x17	2/50
EC GU4025B	B	PCS	dim. 40x25	2/50
EC GU6017B	B	PCS	dim. 60x17	2/50

EXTERNAL ANGLE FOR MINITRUNKINGS



EC AE1517B	B	PCS	dim. 15x17	2/50
EC AE2010B	B	PCS	dim. 20x10	2/50
EC AE2210B	B	PCS	dim. 22x10	2/50
EC AE2517B	B	PCS	dim. 25x17	2/50
EC AE2525B	B	PCS	dim. 25x25	2/50
EC AE3010B	B	PCS	dim. 30x10	2/50
EC AE4010B	B	PCS	dim. 40x10	2/50
EC AE4017B	B	PCS	dim. 40x17	2/50
EC AE4025B	B	PCS	dim. 40x25	2/50
EC AE6017B	B	PCS	dim. 60x17	2/50

T JOINT FOR MINITRUNKINGS

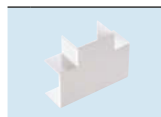

EC T1517B	B	PCS	dim. 15x17	2/50
EC T2010B	B	PCS	dim. 20x10	2/50
EC T2210B	B	PCS	dim. 22x10	2/50
EC T2517B	B	PCS	dim. 25x17	2/50
EC T2525B	B	PCS	dim. 25x25	2/50
EC T3010B	B	PCS	dim. 30x10	2/50
EC T4010B	B	PCS	dim. 40x10	2/50
EC T4017B	B	PCS	dim. 40x17	2/50
EC T4025B	B	PCS	dim. 40x25	2/50
EC T6017B	B	PCS	dim. 60x17	2/50

FLAT ANGLE FOR MINITRUNKINGS



EC AP1517B	B	PCS	dim. 15x17	2/50
EC AP2010B	B	PCS	dim. 20x10	2/50
EC AP2210B	B	PCS	dim. 22x10	2/50
EC AP2517B	B	PCS	dim. 25x17	2/50
EC AP2525B	B	PCS	dim. 25x25	2/50
EC AP3010B	B	PCS	dim. 30x10	2/50
EC AP4010B	B	PCS	dim. 40x10	2/50
EC AP4017B	B	PCS	dim. 40x17	2/50
EC AP4025B	B	PCS	dim. 40x25	2/50
EC AP6017B	B	PCS	dim. 60x17	2/50

END CAP FOR MINITRUNKINGS



EC TT1517B	B	PCS	dim. 15x17	2/50
EC TT2010B	B	PCS	dim. 20x10	2/50
EC TT2210B	B	PCS	dim. 22x10	2/50
EC TT2517B	B	PCS	dim. 25x17	2/50
EC TT2525B	B	PCS	dim. 25x25	2/50
EC TT3010B	B	PCS	dim. 30x10	2/50
EC TT4010B	B	PCS	dim. 40x10	2/50
EC TT4017B	B	PCS	dim. 40x17	2/50
EC TT4025B	B	PCS	dim. 40x25	2/50
EC TT6017B	B	PCS	dim. 60x17	2/50

MINITRUNKING WITH WRAP-AROUND COVER - SERIES MC



ITEM	COLOUR	UM	DESCRIPTION	PACK-AGING
EC MC2213-1B	B	MT	dim. 22x13	100
EC MC3213-1B	B	MT	dim. 32x13	80

ITEM	COLOUR	UM	DESCRIPTION	PACK-AGING	ITEM	COLOUR	UM	DESCRIPTION	PACK-AGING
------	--------	----	-------------	------------	------	--------	----	-------------	------------

INTERNAL ANGLE FOR MINITRUNKINGS



EC AI2213B	B	PCS	dim. 22x13	2/50
EC AI3213B	B	PCS	dim. 32x13	2/50

STRAIGHT JOINT FOR MINITRUNKINGS



EC GU2213B	B	PCS	dim. 22x13	2/50
EC GU3213B	B	PCS	dim. 32x13	2/50

EXTERNAL ANGLE FOR MINITRUNKINGS



EC AE2213B	B	PCS	dim. 22x13	2/50
EC AE3213B	B	PCS	dim. 32x13	2/50

T JOINT FOR MINITRUNKINGS



EC T2213B	B	PCS	dim. 22x13	2/50
EC T3213B	B	PCS	dim. 32x13	2/50

FLAT ANGLE FOR MINITRUNKINGS



EC AP2213B	B	PCS	dim. 22x13	2/50
EC AP3213B	B	PCS	dim. 32x13	2/50

END CAP FOR MINITRUNKINGS



EC TT2213B	B	PCS	dim. 22x13	2/50
EC TT3213B	B	PCS	dim. 32x13	2/50

ADAPTOR BOX "APPAREILLAGE SAILLE"



EC SPA2213B	B	PCS	dim. 118x74x24 for 2213	1/30
EC SPA3213B	B	PCS	dim. 118x74x24 for 3213	1/30

MINITRUNKINGS WITH FRONT-HOOKING COVER - GERMAN TYPE



ITEM	COLOUR	UM	DESCRIPTION	PACK-AGING
EC MC1515B	B	MT	dim. 15x15	100
EC MC1818B	B	MT	dim. 18x18	100
EC MC2020B	B	MT	dim. 20x20	90
EC MC3015B	B	MT	dim. 30x15	80
EC MC3030B	B	MT	dim. 30x30	80

SELF-ADHESIVE MINITRUNKINGS WITH HINGED COVER - SERIES MA

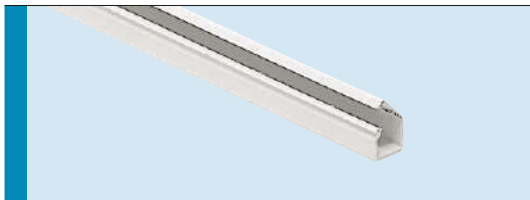

ITEM	COLOUR	UM	DESCRIPTION	PACK-AGING
EC MA1010	B	MT	dim. 10x10	200
EC MA1510	B	MT	dim. 15x10	150
EC MA2010	B	MT	dim. 20x10	100
EC MA125125	B	MT	dim. 12,5x12,5	150
EC MA2075	B	MT	dim. 20x7,5	150
EC MA12575	B	MT	dim. 12,5x7,5	200

FLOOR CABLE TRUNKINGS



ITEM	COLOUR	UM	DESCRIPTION	PACK-AGING
EC CAP5012B	B	MT	dim. 50x12-3 compartments	50
EC CAP5012G	G	MT	dim. 50x12-3 compartments	50
EC CAP7517A	A	MT	dim. 75x17-3 compartments	50
EC CAP7517B	B	MT	dim. 75x17-3 compartments	50
EC CAP7517G	G	MT	dim. 75x17-3 compartments	50

DOUBLE-SIDED MODULAR FLOOR BOXES - SERIES 160

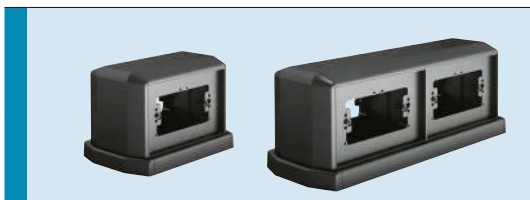

ITEM	COLOUR	UM	DESCRIPTION	PACK-AGING
EC 16001	G	PCS	4 (2+2) device 60 mm hole centre distance	1/10
EC 16002	A	PCS	4 (2+2) device 60 mm hole centre distance	1/10
EC 16001H	G	PCS	4 (2+2) device 60 mm horizontal expansion	1/10
EC 16002H	A	PCS	4 (2+2) device 60 mm horizontal expansion	1/10
EC 16001V	G	PCS	4 (2+2) device 60 mm vertical expansion	1/10
EC 16002V	A	PCS	4 (2+2) device 60 mm vertical expansion	1/10

ITEM	COLOUR	UM	DESCRIPTION	PACK-AGING	ITEM	COLOUR	UM	DESCRIPTION	PACK-AGING	ITEM	COLOUR	UM	DESCRIPTION	PACK-AGING
3-MODULE WALL ADAPTOR BOX 83,5 mm CENTRE HOLE					4-MODULE WALL ADAPTOR BOX 108,5 mm CENTRE HOLE					6-MODULE WALL ADAPTOR BOX 100 mm CENTRE HOLE				
EC SPA70B	B	PCS	for all minitrunkings	1/50	EC SPA80B	B	PCS	for all minitrunkings	1/35	EC SPA90B	B	PCS	for all minitrunkings	1/24
WALL ADAPTOR BOX 60/67 mm CENTRE HOLE					3-MODULE BOX COVER 83,5 mm CENTRE HOLE					WALL ADAPTOR BOX FOR FRENCH STANDARD 45x45 mm				
EC SPA60B	B	PCS	for all minitrunkings	1/25	EC CPB	B	PCS	for SPA70B and similar	5/50	EC SPA45B	B	PCS	for minitrunkings 22x10 and 30x10	1/30
SEPARATION AND DERIVATION BOX					WALL ADAPTOR BOX FOR MAGIC TYPE DEVICE									
EC SSB1	B	PCS	for all minitrunkings	1/25	EC SM0	B	PCS	blank	30					
					EC SM1	B	PCS	1 device	30					
					EC SM2	B	PCS	2 device	30					





CABLE TRUNKINGS WITH COVER SERIES CP - WHITE



ITEM	COLOUR	UM	DESCRIPTION	PACK-AGING
EC CP2540B	B	MT	dim. 25x40	100
EC CP2560B	B	MT	dim. 25x60	70
EC CP2580B	B	MT	dim. 25x80	56
EC CP4040B	B	MT	dim. 40x40	70
EC CP4060B	B	MT	dim. 40x60	56
EC CP4080B	B	MT	dim. 40x80	40
EC CP40100B	B	MT	dim. 40x100	32
EC CP6040B	B	MT	dim. 60x40	50
EC CP6060B	B	MT	dim. 60x60	32
EC CP6080B	B	MT	dim. 60x80	36
EC CP60100B	B	MT	dim. 60x100	24
EC CP8040B	B	MT	dim. 80x40-ready 2 sep.	40
EC CP8060B	B	MT	dim. 80x60-ready 2 sep.	28
EC CP8080B	B	MT	dim. 80x80-ready 2 sep.	30
EC CP80100B	B	MT	dim. 80x100-ready 2 sep.	24
EC CP10040B	B	MT	dim. 100x40-ready 2 sep.	28
EC CP10060B	B	MT	dim. 100x60-ready 2 sep.	20
EC CP10080B	B	MT	dim. 100x80-ready 2 sep.	24
EC CP100100B	B	MT	dim. 100x100-ready 2 sep.	16
EC CP12040B	B	MT	dim. 120x40-ready 2 sep.	24
EC CP12060B	B	MT	dim. 120x60-ready 2 sep.	20
EC CP12080B	B	MT	dim. 120x80-ready 2 sep.	16
EC CP15060B	B	MT	dim. 150x60-ready 4 sep.	16
EC CP20060B	B	MT	dim. 200x60-ready 4 sep.	16
EC CP20080B	B	MT	dim. 200x80-ready 4 sep.	12

CABLE TRUNKINGS WITH COVER SERIES CP - GREY

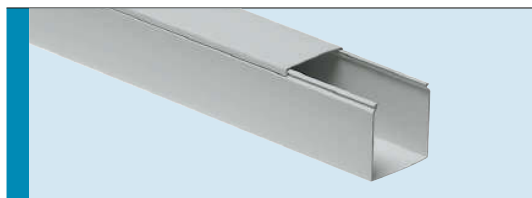

ITEM	COLOUR	UM	DESCRIPTION	PACK-AGING
EC CP2540G	G	MT	dim. 25x40	100
EC CP2560G	G	MT	dim. 25x60	70
EC CP2580G	G	MT	dim. 25x80	56
EC CP4040G	G	MT	dim. 40x40	70
EC CP4060G	G	MT	dim. 40x60	56
EC CP4080G	G	MT	dim. 40x80	40
EC CP40100G	G	MT	dim. 40x100	32
EC CP6040G	G	MT	dim. 60x40	50
EC CP6060G	G	MT	dim. 60x60	32
EC CP6080G	G	MT	dim. 60x80	36
EC CP60100G	G	MT	dim. 60x100	24
EC CP8040G	G	MT	dim. 80x40-ready 2 sep.	40
EC CP8060G	G	MT	dim. 80x60-ready 2 sep.	28
EC CP8080G	G	MT	dim. 80x80-ready 2 sep.	30
EC CP80100G	G	MT	dim. 80x100-ready 2 sep.	24
EC CP10040G	G	MT	dim. 100x40-ready 2 sep.	28
EC CP10060G	G	MT	dim. 100x60-ready 2 sep.	20
EC CP10080G	G	MT	dim. 100x80-ready 2 sep.	24
EC CP100100G	G	MT	dim. 100x100-ready 2 sep.	16
EC CP12040G	G	MT	dim. 120x40-ready 2 sep.	24
EC CP12060G	G	MT	dim. 120x60-ready 2 sep.	20
EC CP12080G	G	MT	dim. 120x80-ready 2 sep.	16
EC CP15060G	G	MT	dim. 150x60-ready 4 sep.	16
EC CP20060G	G	MT	dim. 200x60-ready 4 sep.	16
EC CP20080G	G	MT	dim. 200x80-ready 4 sep.	12

ITEM	COLOUR	UM	DESCRIPTION	PACK-AGING
------	--------	----	-------------	------------

INTERNAL ANGLE FOR TRUNKINGS

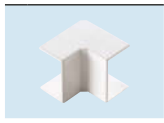

EC AI4040B	B	PCS	dim. 40x40	2/50
EC AI6040B	B	PCS	dim. 60x40	2/50
EC AI6060B	B	PCS	dim. 60x60	10
EC AI8040B	B	PCS	dim. 80x40	10
EC AI8060B	B	PCS	dim. 80x60	10
EC AI8080B	B	PCS	dim. 80x80	10
EC AI10040B	B	PCS	dim. 100x40	10
EC AI10060B	B	PCS	dim. 100x60	10
EC AI10080B	B	PCS	dim. 100x80	10
EC AI12040B	B	PCS	dim. 120x40	10
EC AI12060B	B	PCS	dim. 120x60	10
EC AI12080B	B	PCS	dim. 120x80	10
EC AI15060B	B	PCS	dim. 150x60	8
EC AI20060B	B	PCS	dim. 200x60	5
EC AI20080B	B	PCS	dim. 200x80	5

EXTERNAL ANGLE FOR TRUNKINGS



EC AE4040B	B	PCS	dim. 40x40	2/50
EC AE6040B	B	PCS	dim. 60x40	2/50
EC AE6060B	B	PCS	dim. 60x60	10
EC AE8040B	B	PCS	dim. 80x40	10
EC AE8060B	B	PCS	dim. 80x60	10
EC AE8080B	B	PCS	dim. 80x80	10
EC AE10040B	B	PCS	dim. 100x40	10
EC AE10060B	B	PCS	dim. 100x60	10
EC AE10080B	B	PCS	dim. 100x80	10
EC AE12040B	B	PCS	dim. 120x40	10
EC AE12060B	B	PCS	dim. 120x60	10
EC AE12080B	B	PCS	dim. 120x80	10
EC AE15060B	B	PCS	dim. 150x60	8
EC AE20060B	B	PCS	dim. 200x60	4
EC AE20080B	B	PCS	dim. 200x80	4

FLAT ANGLE FOR TRUNKINGS

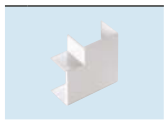

EC AP4040B	B	PCS	dim. 40x40	2/50
EC AP6040B	B	PCS	dim. 60x40	2/50
EC AP6060B	B	PCS	dim. 60x60	10
EC AP8040B	B	PCS	dim. 80x40	10
EC AP8060B	B	PCS	dim. 80x60	10
EC AP8080B	B	PCS	dim. 80x80	10
EC AP10040B	B	PCS	dim. 100x40	10
EC AP10060B	B	PCS	dim. 100x60	10
EC AP10080B	B	PCS	dim. 100x80	10
EC AP12040B	B	PCS	dim. 120x40	10
EC AP12060B	B	PCS	dim. 120x60	10
EC AP12080B	B	PCS	dim. 120x80	8
EC AP15060B	B	PCS	dim. 150x60	8
EC AP20060B	B	PCS	dim. 200x60	8
EC AP20080B	B	PCS	dim. 200x80	6

STRAIGHT JOINT FOR TRUNKINGS



EC GU4040B	B	PCS	dim. 40x40	2/50
EC GU6040B	B	PCS	dim. 60x40	2/50
EC GU6060B	B	PCS	dim. 60x60	20
EC GU8040B	B	PCS	dim. 80x40	20
EC GU8060B	B	PCS	dim. 80x60	20
EC GU8080B	B	PCS	dim. 80x80	20
EC GU10040B	B	PCS	dim. 100x40	20
EC GU10060B	B	PCS	dim. 100x60	20
EC GU10080B	B	PCS	dim. 100x80	20
EC GU12040B	B	PCS	dim. 120x40	20
EC GU12060B	B	PCS	dim. 120x60	10
EC GU12080B	B	PCS	dim. 120x80	10
EC GU15060B	B	PCS	dim. 150x60	10
EC GU20060B	B	PCS	dim. 200x60	10
EC GU20080B	B	PCS	dim. 200x80	10

T JOINT FOR TRUNKINGS



EC T4040B	B	PCS	dim. 40x40	2/50
EC T6040B	B	PCS	dim. 60x40	2/50
EC T6060B	B	PCS	dim. 60x60	10

END CAP FOR TRUNKINGS



EC TT4040B	B	PCS	dim. 40x40	2/50
EC TT6040B	B	PCS	dim. 60x40	2/50
EC TT6060B	B	PCS	dim. 60x60	20
EC TT8040B	B	PCS	dim. 80x40	20
EC TT8060B	B	PCS	dim. 80x60	20
EC TT8080B	B	PCS	dim. 80x80	20
EC TT10040B	B	PCS	dim. 100x40	20
EC TT10060B	B	PCS	dim. 100x60	20
EC TT10080B	B	PCS	dim. 100x80	20
EC TT12040B	B	PCS	dim. 120x40	20
EC TT12060B	B	PCS	dim. 120x60	20
EC TT12080B	B	PCS	dim. 120x80	20
EC TT15060B	B	PCS	dim. 150x60	10
EC TT20060B	B	PCS	dim. 200x60	10
EC TT20080B	B	PCS	dim. 200x80	10

SPARE COVER FOR CABLE TRUNKINGS



EC CR25B	B	MT	width 25	100
EC CR40B	B	MT	width 40	100
EC CR60B	B	MT	width 60	100
EC CR80B	B	MT	width 80	100
EC CR100B	B	MT	width 100	60
EC CR120B	B	MT	width 120	80
EC CR150B	B	MT	width 150	60
EC CR200B	B	MT	width 200	40

ITEM	COLOUR	UM	DESCRIPTION	PACK-AGING	ITEM	COLOUR	UM	DESCRIPTION	PACK-AGING	ITEM	COLOUR	UM	DESCRIPTION	PACK-AGING
------	--------	----	-------------	------------	------	--------	----	-------------	------------	------	--------	----	-------------	------------

CABLE RETAINER FOR CABLE TRUNKINGS



EC CO4040	GC	PCS	dim. 40x40	5/25
EC CO4060	GC	PCS	dim. 40x60	5/25
EC CO4080	GC	PCS	dim. 40x80	5/25
EC CO40100	GC	PCS	dim. 40x100	5/25
EC CO6040	GC	PCS	dim. 60x40	5/25
EC CO6060	GC	PCS	dim. 60x60	5/25
EC CO6080	GC	PCS	dim. 60x80	5/25
EC CO60100	GC	PCS	dim. 60x100	5/25
EC CO8040	GC	PCS	dim. 80x40	5/25
EC CO8060	GC	PCS	dim. 80x60	5/25
EC CO8080	GC	PCS	dim. 80x80	5/25
EC CO80100	GC	PCS	dim. 80x100	5/25
EC CO10040	GC	PCS	dim. 100x40	5/25
EC CO10060	GC	PCS	dim. 100x60	5/25
EC CO10080	GC	PCS	dim. 100x80	5/25
EC CO10010	GC	PCS	dim. 100x100	5/25
EC CO12040	GC	PCS	dim. 120x40	5/25
EC CO12060	GC	PCS	dim. 120x60	5/25
EC CO12080	GC	PCS	dim. 120x80	5/25
EC CO150	GC	PCS	dim. 150	5/25
EC CO200	GC	PCS	dim. 200	5/25

SEPARATION AND DERIVATION BOX



EC SSB2	B	PCS	dim. 165x165x75	1/5
EC SSB3	B	PCS	dim. 250x250x100	1/4

KIT ADAPTOR BOX 83,5 mm CENTRE HOLE DISTANCE



EC KIT80B	B	PCS	trunking 80x60	1/10
EC KIT100B	B	PCS	trunking 100x60	1/10
EC KIT120B	B	PCS	trunking 120x60	1/10
EC KIT150B	B	PCS	trunking 150x60	1/5

KIT ADAPTOR BOX 60/67 mm CENTRE HOLE DISTANCE



EC KIT100A	B	PCS	trunking 100x60	1/10
EC KIT120A	B	PCS	trunking 120x60	1/10
EC KIT150A	B	PCS	trunking 150x60	1/5

KIT ADAPTOR BOX FOR CEE TYPE INDUSTRIAL SOCKETS



EC KIT100C	B	PCS	trunking 100x60	1/10
EC KIT120C	B	PCS	trunking 120x60	1/10
EC KIT150C	B	PCS	trunking 150x60	1/5

CABLE TRUNKINGS WITH COVER DIN DIMENSION SERIES CP



ITEM	COLOUR	UM	DESCRIPTION	PACK-AGING
EC CP5050B	B	MT	dim. 50x50	24
EC CP5050G	G	MT	dim. 50x50	24
EC CP7550B	B	MT	dim. 75x50-ready 2 sep.	40
EC CP7550G	G	MT	dim. 75x50-ready 2 sep.	40

SECTIONABLE SEPARATOR FOR CABLE TRUNKINGS



ITEM	COLOUR	UM	DESCRIPTION	PACK-AGING
EC SESB	B	MT	for H 40-60-80	50
EC SESG	G	MT	for H 40-60-80	50

HALOGEN FREE CABLE TRUNKINGS WITH COVER SERIES CPH - GREY OR WHITE



ITEM	COLOUR	UM	DESCRIPTION	PACK-AGING
EC CPH2540	GC	MT	dim. 25x40	100
EC CPH2560	GC	MT	dim. 25x60	70
EC CPH2580	GC	MT	dim. 25x80	56
EC CPH4040	GC	MT	dim. 40x40	70
EC CPH4060	GC	MT	dim. 40x60	56
EC CPH4080	GC	MT	dim. 40x80	40
EC CPH6040	GC	MT	dim. 60x40	50
EC CPH6060	GC	MT	dim. 60x60	32
EC CPH6080	GC	MT	dim. 60x80	36
EC CPH8040	GC	MT	dim. 80x40	40
EC CPH8060	GC	MT	dim. 80x60	28
EC CPH8080	GC	MT	dim. 80x80	30
EC CPH10040	GC	MT	dim. 100x40	28
EC CPH10060	GC	MT	dim. 100x60	20
EC CPH10080	GC	MT	dim. 100x80	24
EC CPH12040	GC	MT	dim. 120x40	24
EC CPH12060	GC	MT	dim. 120x60	20
EC CPH12080	GC	MT	dim. 120x80	16

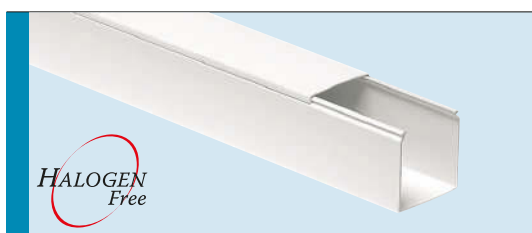

ITEM	COLOUR	UM	DESCRIPTION	PACK-AGING
EC CPH2540B	B	MT	dim. 25x40	100
EC CPH2560B	B	MT	dim. 25x60	70
EC CPH2580B	B	MT	dim. 25x80	56
EC CPH4040B	B	MT	dim. 40x40	70
EC CPH4060B	B	MT	dim. 40x60	56
EC CPH4080B	B	MT	dim. 40x80	40
EC CPH6040B	B	MT	dim. 60x40	50
EC CPH6060B	B	MT	dim. 60x60	32
EC CPH6080B	B	MT	dim. 60x80	36
EC CPH8040B	B	MT	dim. 80x40	40
EC CPH8060B	B	MT	dim. 80x60	28
EC CPH8080B	B	MT	dim. 80x80	30
EC CPH10040B	B	MT	dim. 100x40	28
EC CPH10060B	B	MT	dim. 100x60	20
EC CPH10080B	B	MT	dim. 100x80	24
EC CPH12040B	B	MT	dim. 120x40	24
EC CPH12060B	B	MT	dim. 120x60	20
EC CPH12080B	B	MT	dim. 120x80	16

60x60 DEVICE INSTALLATION TRUNKING WITH COVER

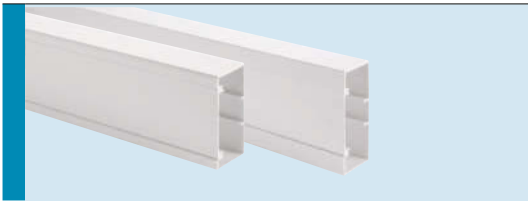

ITEM	COLOUR	UM	DESCRIPTION	PACK-AGING
EC BR11060B	B	MT	Device installation trunking - 110x60	20
EC BR13065B	B	MT	Device installation trunking - 130x65	12
EC BRC80B	B	MT	Spare cover - 80 mm	100

END CAP FOR DEVICE INSTALLATION TRUNKING

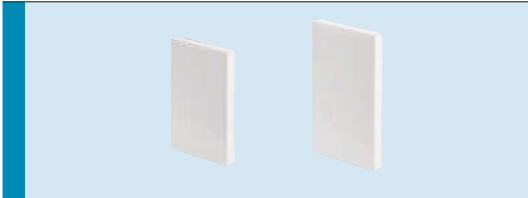

ITEM	COLOUR	UM	DESCRIPTION	PACK-AGING
EC BR111060B	B	PCS	End cap - dim. 110x60	10
EC BR1113065B	B	PCS	End cap - dim. 130x65	10

INTERNAL ANGLE

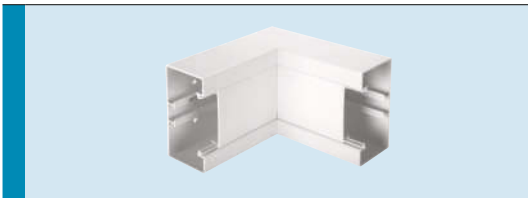

ITEM	COLOUR	UM	DESCRIPTION	PACK-AGING
EC BRAI11060B	B	PCS	Internal angle 110x60	1
EC BRAI13065B	B	PCS	Internal angle 130x65	1

EXTERNAL ANGLE



ITEM	COLOUR	UM	DESCRIPTION	PACK-AGING
EC BRAE11060B	B	PCS	External angle 110x60	1
EC BRAE13065B	B	PCS	External angle 130x65	1

ADAPTOR BOX 60 mm CENTRE HOLE DISTANCE

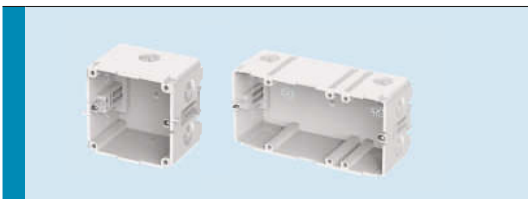

ITEM	COLOUR	UM	DESCRIPTION	PACK-AGING
EC BRS1	B	PCS	Adaptor box 60 mm 1 module - 71x71x50	50
EC BRS2	B	PCS	Adaptor box 60 mm 2 modules - 142x71x50	25

The boxes BRS1 and BRS2 can be mounted on both trunkings and are suitable to be joined together in order to obtain a 3-gang box.

45x45 DEVICE INSTALLATION TRUNKINGS WITH COVER



ITEM	COLOUR	UM	DESCRIPTION	PACK-AGING
EC 2209055	B	MT	dim. 90x55	24
EC 22013555-2	B	MT	dim. 135x55-2 compartments	16
EC 22016555-3	B	MT	dim. 165x55-3 compartments	16

ITEM	COLOUR	UM	DESCRIPTION	PACK-AGING
------	--------	----	-------------	------------

STRAIGHT JOINT

	EC 220GU9055	B	PCS	dim. 90x55 and 135x55	10/50
	EC 220GU16555	B	PCS	dim. 165x55	10/50

COVER JOINT

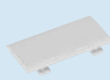
	EC 220GC45	B	PCS	cover joint 45	5/50
--	-------------------	---	-----	----------------	------

COVER/DEVICE JOINT

	EC 220GA45	B	PCS	vertical fixing device	5/50
--	-------------------	---	-----	------------------------	------

VARIABLE INTERNAL ANGLE

	EC 220AI9055	B	PCS	dim. 90x55	1/10
	EC 220AI13555	B	PCS	dim. 135x55	1/10
	EC 220AI16555	B	PCS	dim. 165x55	1/10

VARIABLE EXTERNAL ANGLE

	EC 220AE9055	B	PCS	dim. 90x55	1/10
	EC 220AE13555	B	PCS	dim. 135x55	1/8
	EC 220AE16555	B	PCS	dim. 165x55	1/8

FLAT ANGLE

	EC 220AP9055	B	PCS	dim. 90x55	1/10
	EC 220AP13555	B	PCS	dim. 135x55	1/8
	EC 220AP16555	B	PCS	dim. 165x55	1/8

END CAP

	EC 220TT9055	B	PCS	dim. 90x55	2/10
	EC 220TT13555	B	PCS	dim. 135x55	2/10
	EC 220TT16555	B	PCS	dim. 165x55	2/10



ITEM	COLOUR	UM	DESCRIPTION	PACK-AGING
------	--------	----	-------------	------------

ADDITIONAL AND BOTTOM COVERS



EC 220CC25	B	PCS	bottom cover	50
EC 220CC45	B	MT	additional cover	50

ITEM	COLOUR	UM	DESCRIPTION	PACK-AGING
------	--------	----	-------------	------------

SEPARATION AND DERIVATION BOX



EC SSB2	B	PCS	dim. 165x165x75	1/5
EC SSB3	B	PCS	dim. 250x250x100	1/4

SKIRTING BOARD AND WALL TRUNKING 70x20 - 130x28



ITEM	COLOUR	UM	DESCRIPTION	PACK-AGING
EC 20001	B	MT	skirting board 70x20	24
EC 20101	A	MT	skirting board 70x20	24
EC 20201	B	MT	skirting board 130x28	20
EC 20301	A	MT	skirting board 130x28	20

ITEM	COLOUR	UM	DESCRIPTION	PACK-AGING	ITEM	COLOUR	UM	DESCRIPTION	PACK-AGING
------	--------	----	-------------	------------	------	--------	----	-------------	------------

COMPARTMENT LID



EC 20202	B	MT	compartment lid	100
EC 20302	A	MT	compartment lid	100

VARIABLE FLAT ANGLE



EC 20005	B	PCS	flat angle - 70x20	1/10
EC 20105	A	PCS	flat angle - 70x20	1/10
EC 20205	B	PCS	flat angle - 130x28	1/5
EC 20305	A	PCS	flat angle - 130x28	1/5

VARIABLE INTERNAL ANGLE



EC 20003	B	PCS	internal angle - 70x20	5/25
EC 20103	A	PCS	internal angle - 70x20	5/25
EC 20203	B	PCS	internal angle - 130x28	5
EC 20303	A	PCS	internal angle - 130x28	5

COVER STRAIGHT JOINT



EC 20006		PCS	cover joint - 70x20	5/25
EC 20106		PCS	cover joint - 70x20	5/25
EC 20206	B	PCS	cover joint - 130x28	5/20
EC 20306	A	PCS	cover joint - 130x28	5/20

VARIABLE EXTERNAL ANGLE



EC 20004	B	PCS	external angle - 70x20	5/25
EC 20104	A	PCS	external angle - 70x20	5/25
EC 20204	B	PCS	external angle - 130x28	5
EC 20304	A	PCS	external angle - 130x28	5

END CAP



EC 20008	B	PCS	end cap - 70x20	5/25
EC 20108	A	PCS	end cap - 70x20	5/25
EC 20208	B	PCS	end cap - 130x28	5/20
EC 20308	A	PCS	end cap - 130x28	5/20

STRAIGHT JOINT



EC 20207	B	PCS	straight joint - 130x28	5/20
EC 20307	A	PCS	straight joint - 130x28	5/20

ITEM	COLOUR	UM	DESCRIPTION	PACK-AGING	ITEM	COLOUR	UM	DESCRIPTION	PACK-AGING	ITEM	COLOUR	UM	DESCRIPTION	PACK-AGING
------	--------	----	-------------	------------	------	--------	----	-------------	------------	------	--------	----	-------------	------------

3-WAY JUNCTION BOX 70x20

EC 20009	B	PCS	3-way junction box	1/5
EC 20109	A	PCS	3-way junction box	1/5

TOWER DEVICE BOX - 3 MODULES 70x20

EC 20010	B	PCS	tower device box - 3 mod.	1/10
EC 20110	A	PCS	tower device box - 3 mod.	1/10

TOWER DEVICE BOX - 4 MODULES 70x20

EC 20015	B	PCS	tower device box - 4 mod.	1/10
EC 20115	A	PCS	tower device box - 4 mod.	1/10

TOWER DEVICE BOX - 6 MODULES 70x20

EC 20016	B	PCS	tower device box - 6 mod.	1/8
EC 20116	A	PCS	tower device box - 6 mod.	1/8

WALL DEVICE BOX - 3 MODULES 70x20

EC 20011	B	PCS	wall device box - 3 mod.	1/10
EC 20111	A	PCS	wall device box - 3 mod.	1/10

3-WAY JUNCTION BOX 130x28

EC 20209	B	PCS	3-way junction box	1/5
EC 20309	A	PCS	3-way junction box	1/5

TOWER DEVICE BOX - 3 MODULES 130x28

EC 20210	B	PCS	tower device box - 3 mod.	1/6
EC 20310	A	PCS	tower device box - 3 mod.	1/6

TOWER DEVICE BOX - 4 MODULES 130x28

EC 20215	B	PCS	tower device box - 4 mod.	1/10
EC 20315	A	PCS	tower device box - 4 mod.	1/10

TOWER DEVICE BOX - 6 MODULES 130x28

EC 20216	B	PCS	tower device box - 6 mod.	1/10
EC 20316	A	PCS	tower device box - 6 mod.	1/10

TOWER DEVICE BOX - 8 MODULES 130x28

EC 20211	B	PCS	tower device box - 8 mod.	1/4
EC 20311	A	PCS	tower device box - 8 mod.	1/4

3/4/6-MODULE BOX COVER

EC 20212	B	PCS	3-module box cover	1/50
EC 20312	A	PCS	3-module box cover	1/50
EC 20213	B	PCS	4-module box cover	1/50
EC 20214	B	PCS	6-module box cover	1/50

DUCT FOR AIR CONDITIONING INSTALLATION

SPLIT system



* Cover supplied with protective film

ITEM	COLOUR	UM	DESCRIPTION	PACK-AGING
EC 9006040	B	MT	dim. 60x40	30
EC 9007055	B	MT	dim. 70x55	24
EC 9008060 *	B	MT	dim. 80x60	16
EC 9009065	B	MT	dim. 90x65	16
EC 90010060	B	MT	dim. 100x60	16
EC 90011075 *	B	MT	dim. 110x75	16
EC 90014090 *	B	MT	dim. 140x90	8

ITEM	COLOUR	UM	DESCRIPTION	PACK-AGING
------	--------	----	-------------	------------

INTERNAL ANGLE

EC 9106040	B	PCS	dim. 60x40	10
EC 9107055	B	PCS	dim. 70x55	10
EC 9108060	B	PCS	dim. 80x60	10
EC 9109065	B	PCS	dim. 90x65	10
EC 91010060	B	PCS	dim. 100x60	10
EC 91011075	B	PCS	dim. 110x75	10
EC 91014090	B	PCS	dim. 140x90	10

EXTERNAL ANGLE

EC 9206040	B	PCS	dim. 60x40	10
EC 9207055	B	PCS	dim. 70x55	10
EC 9208060	B	PCS	dim. 80x60	10
EC 9209065	B	PCS	dim. 90x65	10
EC 92010060	B	PCS	dim. 100x60	10
EC 92011075	B	PCS	dim. 110x75	10
EC 92014090	B	PCS	dim. 140x90	10

FLAT ANGLE

EC 9306040	B	PCS	dim. 60x40	10
EC 9307055	B	PCS	dim. 70x55	10
EC 9308060	B	PCS	dim. 80x60	10
EC 9309065	B	PCS	dim. 90x65	10
EC 93010060	B	PCS	dim. 100x60	10
EC 93011075	B	PCS	dim. 110x75	10
EC 93014090	B	PCS	dim. 140x90	10

STRAIGHT JOINT

EC 9406040	B	PCS	dim. 60x40	20
EC 9407055	B	PCS	dim. 70x55	20
EC 9408060	B	PCS	dim. 80x60	20
EC 9409065	B	PCS	dim. 90x65	20
EC 94010060	B	PCS	dim. 100x60	20
EC 94011075	B	PCS	dim. 110x75	10
EC 94014090	B	PCS	dim. 140x90	20

ITEM	COLOUR	UM	DESCRIPTION	PACK-AGING
------	--------	----	-------------	------------

T JOINT

EC 9506040	B	PCS	dim. 60x40	10
EC 9507055	B	PCS	dim. 70x55	10
EC 9508060	B	PCS	dim. 80x60	10
EC 9509065	B	PCS	dim. 90x65	10
EC 95010060	B	PCS	dim. 100x60	10
EC 95011075	B	PCS	dim. 110x75	10
EC 95014090	B	PCS	dim. 140x90	10

END CAP

EC 9606040	B	PCS	dim. 60x40	20
EC 9607055	B	PCS	dim. 70x55	20
EC 9608060	B	PCS	dim. 80x60	20
EC 9609065	B	PCS	dim. 90x65	20
EC 96010060	B	PCS	dim. 100x60	20
EC 96011075	B	PCS	dim. 110x75	10
EC 96014090	B	PCS	dim. 140x90	20

WALL THROUGH STRAIGHT JOINT

EC 9706040	B	PCS	dim. 60x40	20
EC 9707055	B	PCS	dim. 70x55	20
EC 9708060	B	PCS	dim. 80x60	20
EC 9709065	B	PCS	dim. 90x65	20
EC 97010060	B	PCS	dim. 100x60	20
EC 97011075	B	PCS	dim. 110x75	10
EC 97014090	B	PCS	dim. 140x90	20

WALL TROUGH BENT JOINT

EC 9806040	B	PCS	dim. 60x40	10
EC 9807055	B	PCS	dim. 70x55	10
EC 9808060	B	PCS	dim. 80x60	10
EC 9809065	B	PCS	dim. 90x65	10
EC 98010060	B	PCS	dim. 100x60	10
EC 98011075	B	PCS	dim. 110x75	10
EC 98014090	B	PCS	dim. 140x90	10

ITEM	COLOUR	UM	DESCRIPTION	PACK-AGING	ITEM	COLOUR	UM	DESCRIPTION	PACK-AGING	ITEM	COLOUR	UM	DESCRIPTION	PACK-AGING
------	--------	----	-------------	------------	------	--------	----	-------------	------------	------	--------	----	-------------	------------

CONDUIT RETAINER

EC 9036040	B	PCS	dim. 60x40	30
EC 9037055	B	PCS	dim. 70x55	30
EC 9038060	B	PCS	dim. 80x60	30
EC 9039065	B	PCS	dim. 90x65	30
EC 90311075	B	PCS	dim. 110x75	30
EC 90314090	B	PCS	dim. 140x90	30

ARRANGEMENT BOX FOR CONDENSATE DRAINING

EC 90201	B	PCS	455x100x65 mm	1/20
-----------------	---	-----	---------------	------

EXTERNAL COOLING UNIT FLOOR SUPPORT

EC 90401	B	PCS	dim. 90x80x350	24
EC 90402	B	PCS	dim. 90x80x450	24
EC 90403	B	PCS	end cap 90x80	24
EC 90411	B	PCS	dim. 115x75x420	24

FLEXIBLE SPIRAL CONDUIT FOR CONDENSATE DRAINING

EC 990GFE16	B	MT	Ø 16/20,2	30/4050
EC 990GFE18	B	MT	Ø 18/22,2	30/3360
EC 990GFE20	B	MT	Ø 20/24,2	30/3360

UNIVERSAL FITTING FOR CONDENSATE DRAINING CONDUIT

EC 901Y	B	PCS	Ø 16/18/20	20
----------------	---	-----	------------	----

new items in this page

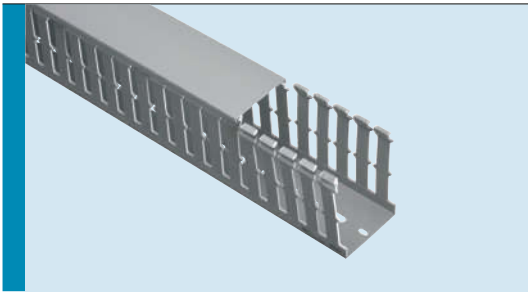
SLOTTED TRUNKINGS WITH COVER 8/12/8 TYPE

ITEM	COLOUR	UM	DESCRIPTION	PACK-AGING
EC A2525	G	MT	dim. 25x25	100
EC A2540	G	MT	dim. 25x40	100
EC A2560	G	MT	dim. 25x60	70
EC A2580	G	MT	dim. 25x80	56
EC A4025	G	MT	dim. 40x25	80
EC A4040	G	MT	dim. 40x40	70
EC A4060	G	MT	dim. 40x60	56
EC A4080	G	MT	dim. 40x80	40
EC A40100	G	MT	dim. 40x100	32
EC A6040	G	MT	dim. 60x40	50
EC A6060	G	MT	dim. 60x60	32
EC A6080	G	MT	dim. 60x80	36
EC A60100	G	MT	dim. 60x100	24
EC A8040	G	MT	dim. 80x40-ready 2 sep.	40
EC A8060	G	MT	dim. 80x60-ready 2 sep.	28
EC A8080	G	MT	dim. 80x80-ready 2 sep.	30
EC A80100	G	MT	dim. 80x100-ready 2 sep.	24
EC A10040	G	MT	dim. 100x40-ready 2 sep.	28
EC A10060	G	MT	dim. 100x60-ready 2 sep.	20
EC A10080	G	MT	dim. 100x80-ready 2 sep.	24
EC A100100	G	MT	dim. 100x100-ready 2 sep.	16
EC A12040	G	MT	dim. 120x40-ready 2 sep.	24
EC A12060	G	MT	dim. 120x60-ready 2 sep.	20
EC A12080	G	MT	dim. 120x80-ready 2 sep.	16

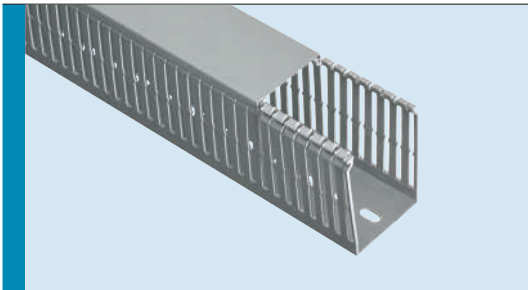
SLOTTED TRUNKINGS WITH COVER 4/6/4 TYPE

ITEM	COLOUR	UM	DESCRIPTION	PACK-AGING
EC S2525	G	MT	dim. 25x25	100
EC S2540	G	MT	dim. 25x40	100
EC S2560	G	MT	dim. 25x60	70
EC S2580	G	MT	dim. 25x80	56
EC S4025	G	MT	dim. 40x25	80
EC S4040	G	MT	dim. 40x40	70
EC S4060	G	MT	dim. 40x60	56
EC S4080	G	MT	dim. 40x80	40
EC S40100	G	MT	dim. 40x100	32
EC S6040	G	MT	dim. 60x40	50
EC S6060	G	MT	dim. 60x60	32
EC S6080	G	MT	dim. 60x80	36
EC S60100	G	MT	dim. 60x100	24
EC S8040	G	MT	dim. 80x40-ready 2 sep.	40
EC S8060	G	MT	dim. 80x60-ready 2 sep.	28
EC S8080	G	MT	dim. 80x80-ready 2 sep.	30
EC S80100	G	MT	dim. 80x100-ready 2 sep.	24
EC S10040	G	MT	dim. 100x40-ready 2 sep.	28
EC S10060	G	MT	dim. 100x60-ready 2 sep.	20
EC S10080	G	MT	dim. 100x80-ready 2 sep.	24
EC S100100	G	MT	dim. 100x100-ready 2 sep.	16
EC S12040	G	MT	dim. 120x40-ready 2 sep.	24
EC S12060	G	MT	dim. 120x60-ready 2 sep.	20
EC S12080	G	MT	dim. 120x80-ready 2 sep.	16

FLEXIBLE SLOTTED TRUNKINGS

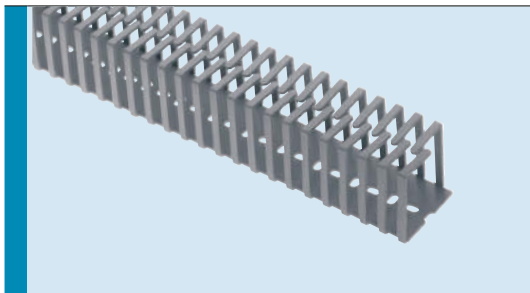

ITEM	COLOUR	UM	DESCRIPTION	PACK-AGING
EC 23401	G	PCS	12,5x12,5x500	112
EC 23402	G	PCS	16x16x500	84
EC 23403	G	PCS	20x20x500	112
EC 23404	G	PCS	25x25x500	70
EC 23405	G	PCS	30x30x500	50
EC 23406	G	PCS	40x40x500	50
EC 23407	G	PCS	50x50x500	32
EC 23411	G	PCS	12,5x12,5x500 - self-adhesive	112
EC 23412	G	PCS	16x16x500 - self-adhesive	84
EC 23413	G	PCS	20x20x500 - self-adhesive	112
EC 23414	G	PCS	25x25x500 - self-adhesive	70
EC 23415	G	PCS	30x30x500 - self-adhesive	50
EC 23416	G	PCS	40x40x500 - self-adhesive	50
EC 23417	G	PCS	50x50x500 - self-adhesive	32

PRE-CUT TRUNKING FOR CONDUIT

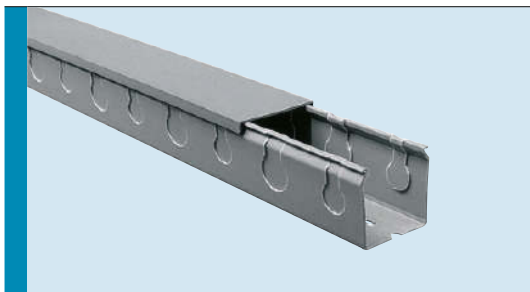

ITEM	COLOUR	UM	DESCRIPTION	PACK-AGING
EC P5050	G	MT	dim. 50x50-Ø9-23	24
EC P7550	G	MT	dim. 75x50-Ø9-23	40

ITEM	COLOUR	UM	DESCRIPTION	PACK-AGING
------	--------	----	-------------	------------

SPARE COVER FOR SLOTTED TRUNKINGS



EC CR25G	G	MT	width 25	100
EC CR40G	G	MT	width 40	100
EC CR60G	G	MT	width 60	100
EC CR80G	G	MT	width 80	100
EC CR100G	G	MT	width 100	60
EC CR120G	G	MT	width 120	80

ITEM	COLOUR	UM	DESCRIPTION	PACK-AGING	ITEM	COLOUR	UM	DESCRIPTION	PACK-AGING	ITEM	COLOUR	UM	DESCRIPTION	PACK-AGING
SECTIONABLE SEPARATOR FOR SLOTTED TRUNKINGS 					CUTTING MACHINE FOR TRUNKINGS 					CABLE RETAINER FOR SLOTTED TRUNKINGS 				
EC SESG	G	MT	for H 40-60-80	50	EC ADC	PCS	1	hand cutting machine cut dimensions W=120 - H=120	1	EC CO4040	GC	PCS	dim. 40x40	5/25
DIN RAILS EN 50022 										EC CO4060 GC PCS dim. 40x60 5/25 EC CO4080 GC PCS dim. 40x80 5/25 EC CO40100 GC PCS dim. 40x100 5/25 EC CO6040 GC PCS dim. 60x40 5/25 EC CO6060 GC PCS dim. 60x60 5/25 EC CO6080 GC PCS dim. 60x80 5/25 EC CO60100 GC PCS dim. 60x100 5/25 EC CO8040 GC PCS dim. 80x40 5/25 EC CO8060 GC PCS dim. 80x60 5/25 EC CO8080 GC PCS dim. 80x80 5/25 EC CO80100 GC PCS dim. 80x100 5/25 EC CO10040 GC PCS dim. 100x40 5/25 EC CO10060 GC PCS dim. 100x60 5/25 EC CO10080 GC PCS dim. 100x80 5/25 EC CO100100 GC PCS dim. 100x100 5/25 EC CO12040 GC PCS dim. 120x40 5/25 EC CO12060 GC PCS dim. 120x60 5/25 EC CO12080 GC PCS dim. 120x80 5/25				
EC 460	PCS	35x7,5x1 - 2 mt		20										
EC 46015	PCS	35x15x1,5 - 2 mt		10										
EC 460F	PCS	35x7,5x1 - 2 mt perforated		20										

HALOGEN FREE SLOTTED TRUNKINGS WITH COVER 8/12/8 TYPE

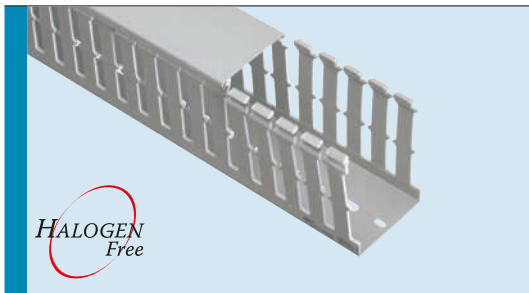

ITEM	COLOUR	UM	DESCRIPTION	PACK-AGING
EC AH2540	GC	MT	dim. 25x40	100
EC AH2560	GC	MT	dim. 25x60	70
EC AH2580	GC	MT	dim. 25x80	56
EC AH4040	GC	MT	dim. 40x40	70
EC AH4060	GC	MT	dim. 40x60	56
EC AH4080	GC	MT	dim. 40x80	40
EC AH6040	GC	MT	dim. 60x40	50
EC AH6060	GC	MT	dim. 60x60	32
EC AH6080	GC	MT	dim. 60x80	36
EC AH8040	GC	MT	dim. 80x40	40
EC AH8060	GC	MT	dim. 80x60	28
EC AH8080	GC	MT	dim. 80x80	30
EC AH10040	GC	MT	dim. 100x40	28
EC AH10060	GC	MT	dim. 100x60	20
EC AH10080	GC	MT	dim. 100x80	24
EC AH12040	GC	MT	dim. 120x40	24
EC AH12060	GC	MT	dim. 120x60	20
EC AH12080	GC	MT	dim. 120x80	16

new items
in this page

HALOGEN FREE SLOTTED TRUNKINGS WITH COVER 4/6/4 TYPE

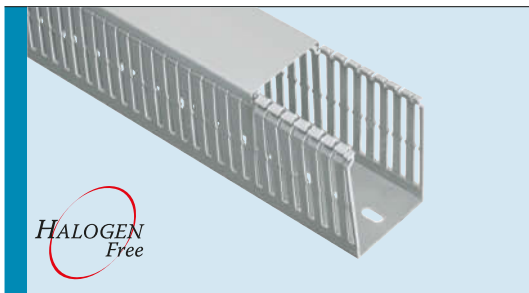

ITEM	COLOUR	UM	DESCRIPTION	PACK-AGING
EC SH2540	GC	MT	dim. 25x40	100
EC SH2560	GC	MT	dim. 25x60	70
EC SH2580	GC	MT	dim. 25x80	56
EC SH4040	GC	MT	dim. 40x40	70
EC SH4060	GC	MT	dim. 40x60	56
EC SH4080	GC	MT	dim. 40x80	40
EC SH6040	GC	MT	dim. 60x40	50
EC SH6060	GC	MT	dim. 60x60	32
EC SH6080	GC	MT	dim. 60x80	36
EC SH8040	GC	MT	dim. 80x40	40
EC SH8060	GC	MT	dim. 80x60	28
EC SH8080	GC	MT	dim. 80x80	30
EC SH10040	GC	MT	dim. 100x40	28
EC SH10060	GC	MT	dim. 100x60	20
EC SH10080	GC	MT	dim. 100x80	24
EC SH12040	GC	MT	dim. 120x40	24
EC SH12060	GC	MT	dim. 120x60	20
EC SH12080	GC	MT	dim. 120x80	16

ITEM	COLOUR	UM	DESCRIPTION	PACK-AGING
------	--------	----	-------------	------------

SPARE COVER FOR HALOGEN FREE SLOTTED TRUNKINGS



EC CR25HG	GC	MT	width 25	100
EC CR40HG	GC	MT	width 40	100
EC CR60HG	GC	MT	width 60	100
EC CR80HG	GC	MT	width 80	100
EC CR100HG	GC	MT	width 100	60
EC CR120HG	GC	MT	width 120	80

SPIRAL WRAP IN TRANSPARENT POLYTHENE



EC P1.5	MT	internal Ø 1,5	25/500
EC P03	MT	internal Ø 3	25/500
EC P04	MT	internal Ø 4	25/500
EC P06	MT	internal Ø 6	25/300
EC P08	MT	internal Ø 8	25/200
EC P10	MT	internal Ø 10	25/150
EC P12	MT	internal Ø 12	20/120
EC P14	MT	internal Ø 14	20/100

ITEM	COLOUR	UM	DESCRIPTION	PACK-AGING
------	--------	----	-------------	------------

SPIRAL WRAP IN BLACK POLYTHENE



EC PN1.5	MT	internal Ø 1,5	25/500
EC PN03	MT	internal Ø 3	25/500
EC PN04	MT	internal Ø 4	25/500
EC PN06	MT	internal Ø 6	25/300
EC PN08	MT	internal Ø 8	25/200
EC PN10	MT	internal Ø 10	25/150
EC PN12	MT	internal Ø 12	20/120
EC PN14	MT	internal Ø 14	20/100

SPIRAL WRAP IN SELF-EXTINGUISHING POLYTHENE



EC PA1.5	MT	internal Ø 1,5	25/500
EC PA03	MT	internal Ø 3	25/500
EC PA04	MT	internal Ø 4	25/500
EC PA06	MT	internal Ø 6	25/300
EC PA08	MT	internal Ø 8	25/200
EC PA10	MT	internal Ø 10	25/150
EC PA12	MT	internal Ø 12	20/120
EC PA14	MT	internal Ø 14	20/100

INDUSTRIAL SYSTEMS



1

INDUSTRIAL PLUGS AND SOCKETS



2

DISTRIBUTION BOARDS



3

SAFETY SWITCHES

MAIN TECHNICAL FEATURES

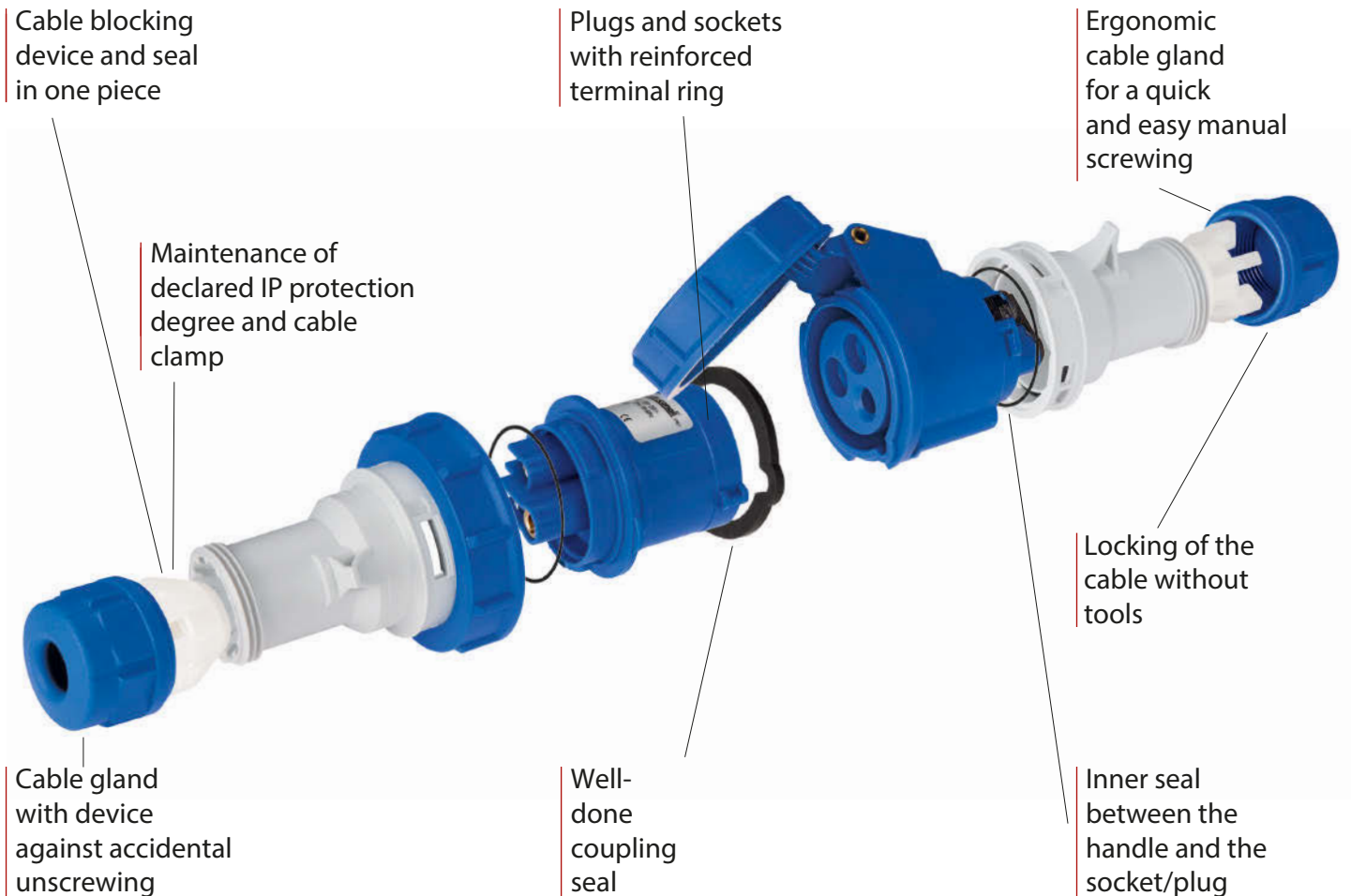

The sockets and the plugs of the Series 690 are very quick to open, cable and close thanks to their ergonomic design combined with some up-dated technical solutions. They are entirely made up of UV-resistant self-extinguishing polyamide 6 and are particularly suitable for outdoor uses thanks to their high resistance to compression, shocks and crushes that can occur, for example, on construc-

tion sites. The contacts are made of brass alloy with high conductivity of $15 \text{ m}/(\text{Ohm mm}^2)$ and the conductive parts of the 63A/125A sockets have got a spring device made up of copper-beryllium alloy which guarantees a better contact and prevents from corrosion. The IP protection degree and the the cable locking are carried out through the tulip-shaped one-

piece device made of two different types of polymer, which are co-moulded: it is simply necessary to insert the cable and tighten the nut until it locks. The cable gland is characterized by a special unscrewing device that prevents from any accidental release of the clamp; besides it doesn't get lost during the wiring operations.

STRAIGHT PLUGS EN 60309 - IP44 - 16A



ITEM	COLOUR	UM	DESCRIPTION	PACK-AGING
EC 69 470		PCS	2P-20-25V	10/80
EC 69 471		PCS	3P-20-25V	10/80
EC 69 170		PCS	2P+⊕-100-130V	10/80
EC 69 171		PCS	3P+⊕-100-130V	10/80
EC 69 070		PCS	2P+⊕-200-250V	10/80
EC 69 270		PCS	3P+⊕-200-250V	10/80
EC 69 271		PCS	3P+N+⊕-208-250V	10/80
EC 69 072		PCS	3P+⊕-380-415V	10/80
EC 69 074		PCS	3P+N+⊕-346-415V	10/80

STRAIGHT PLUGS EN 60309 - IP44 - 32A

EC 69 172		PCS	2P+⊕-100-130V	10/80
EC 69 173		PCS	3P+⊕-100-130V	10/80
EC 69 272		PCS	2P+⊕-200-250V	10/80
EC 69 273		PCS	3P+⊕-200-250V	10/80
EC 69 076		PCS	3P+⊕-380-415V	10/80
EC 69 078		PCS	3P+N+⊕-346-415V	10/60

STRAIGHT PLUGS EN 60309 - IP67 - 16A



ITEM	COLOUR	UM	DESCRIPTION	PACK-AGING
EC 69 472		PCS	2P- 20-25V	10/80
EC 69 473		PCS	3P- 20-25V	10/60
EC 69 174		PCS	2P+⊕-100-130V	10/80
EC 69 175		PCS	3P+⊕-100-130V	10/60
EC 69 071		PCS	2P+⊕-200-250V	10/80
EC 69 274		PCS	3P+⊕-200-250V	10/60
EC 69 275		PCS	3P+N+⊕-208-250V	10/40
EC 69 073		PCS	3P+⊕-380-415V	10/60
EC 69 075		PCS	3P+N+⊕-346-415V	10/60

STRAIGHT PLUGS EN 60309 - IP67 - 32A

EC 69 176		PCS	2P+⊕-100-130V	10/40
EC 69 177		PCS	3P+⊕-100-130V	10/40
EC 69 276		PCS	2P+⊕-200-250V	10/40
EC 69 277		PCS	3P+⊕-200-250V	10/40
EC 69 077		PCS	3P+⊕-380-415V	10/40
EC 69 079		PCS	3P+N+⊕-346-415V	10/40

STRAIGHT PLUGS EN 60309 - IP67 - 63A



ITEM	COLOUR	UM	DESCRIPTION	PACK-AGING
EC 69 278		PCS	2P+⊕-200-250V	2/16
EC 69 279		PCS	3P+⊕-200-250V	2/16
EC 69 370		PCS	3P+⊕-380-415V	2/16
EC 69 371		PCS	3P+N+⊕-346-415V	2/16

STRAIGHT PLUGS EN 60309 - IP67 - 125A



EC 69 671		PCS	2P+⊕-200-250V	2/8
EC 69 674		PCS	3P+⊕-200-250V	2/8
EC 69 673		PCS	3P+⊕-380-415V	2/8
EC 69 675		PCS	3P+N+⊕-346-415V	2/8

BELG./FRENCH-GERMAN SYSTEM PLUGS - IP44



EC 6902F		PCS	B/F Angled plug	20
EC 6903F		PCS	B/F Straight plug	20
EC 6902D		PCS	German Angled plug	20
EC 6903D		PCS	German Straight plug	20

STRAIGHT SOCKETS EN 60309 - IP44 - 16A



ITEM	COLOUR	UM	DESCRIPTION	PACK-AGING
EC 69 480		PCS	2P-20-25V	10/80
EC 69 481		PCS	3P-20-25V	10/80
EC 69 180		PCS	2P+⊕-100-130V	10/80
EC 69 181		PCS	3P+⊕-100-130V	10/80
EC 69 080		PCS	2P+⊕-200-250V	10/80
EC 69 280		PCS	3P+⊕-200-250V	10/80
EC 69 281		PCS	3P+N+⊕-208-250V	10/80
EC 69 082		PCS	3P+⊕-380-415V	10/80
EC 69 084		PCS	3P+N+⊕-346-415V	10/80

STRAIGHT SOCKETS EN 60309 - IP44 - 32A

EC 69 182		PCS	2P+⊕-100-130V	10/60
EC 69 183		PCS	3P+⊕-100-130V	10/60
EC 69 282		PCS	2P+⊕-200-250V	10/60
EC 69 283		PCS	3P+⊕-200-250V	10/60
EC 69 086		PCS	3P+⊕-380-415V	10/60
EC 69 088		PCS	3P+N+⊕-346-415V	10/40

STRAIGHT SOCKETS EN 60309 - IP67 - 16A



ITEM	COLOUR	UM	DESCRIPTION	PACK-AGING
EC 69 482		PCS	2P- 20-25V	10/80
EC 69 483		PCS	3P- 20-25V	10/60
EC 69 184		PCS	2P+⊕-100-130V	10/80
EC 69 185		PCS	3P+⊕-100-130V	10/60
EC 69 081		PCS	2P+⊕-200-250V	10/80
EC 69 284		PCS	3P+⊕-200-250V	10/60
EC 69 285		PCS	3P+N+⊕-208-250V	10/40
EC 69 083		PCS	3P+⊕-380-415V	10/60
EC 69 085		PCS	3P+N+⊕-346-415V	10/40

STRAIGHT SOCKETS EN 60309 - IP67 - 32A

EC 69 186		PCS	2P+⊕-100-130V	10/60
EC 69 187		PCS	3P+⊕-100-130V	10/60
EC 69 286		PCS	2P+⊕-200-250V	10/60
EC 69 287		PCS	3P+⊕-200-250V	10/60
EC 69 087		PCS	3P+⊕-380-415V	10/40
EC 69 089		PCS	3P+N+⊕-346-415V	10/40

ITEM	COLOUR	UM	DESCRIPTION	PACK-AGING
------	--------	----	-------------	------------

STRAIGHT SOCKETS EN 60309 - IP67 - 63A



EC 69 288		PCS	2P+⊕-200-250V	2/16
EC 69 289		PCS	3P+⊕-200-250V	2/16
EC 69 380		PCS	3P+⊕-380-415V	2/16
EC 69 381		PCS	3P+N+⊕-346-415V	2/16

ITEM	COLOUR	UM	DESCRIPTION	PACK-AGING
------	--------	----	-------------	------------

STRAIGHT SOCKETS EN 60309 - IP67 - 125A



EC 69 681		PCS	2P+⊕-200-250V	2/8
EC 69 684		PCS	3P+⊕-200-250V	2/8
EC 69 683		PCS	3P+⊕-380-415V	2/8
EC 69 685		PCS	3P+N+⊕-346-415V	2/8

BELG./FRENCH-GERMAN SYSTEM SOCKETS - IP20/44



EC 6906F		PCS	B/F IP20 Socket	20
EC 6907F		PCS	B/F IP44 (cap) Socket	20
EC 6906D		PCS	German IP20 Socket	20
EC 6907D		PCS	German IP44 (cap) Socket	20

PANEL MOUNTING INCLINED SOCKETS EN 60309 - IP44 - 16A



ITEM	COLOUR	UM	DESCRIPTION	PACK-AGING
EC 69 400		PCS	2P-20-25V	10/80
EC 69 401		PCS	3P-20-25V	10/80
EC 69 100		PCS	2P+⊕-100-130V	10/80
EC 69 101		PCS	3P+⊕-100-130V	10/80
EC 69 050		PCS	2P+⊕-200-250V	10/80
EC 69 250		PCS	3P+⊕-200-250V	10/80
EC 69 251		PCS	3P+N+⊕-208-250V	10/60
EC 69 052		PCS	3P+⊕-380-415V	10/80
EC 69 054		PCS	3P+N+⊕-346-415V	10/60

PANEL MOUNTING INCLINED SOCKETS EN 60309 - IP44 - 32A

EC 69 102		PCS	2P+⊕-100-130V	10/60
EC 69 103		PCS	3P+⊕-100-130V	10/60
EC 69 252		PCS	2P+⊕-200-250V	10/60
EC 69 253		PCS	3P+⊕-200-250V	10/60
EC 69 060		PCS	3P+⊕-380-415V	10/60
EC 69 061		PCS	3P+N+⊕-346-415V	10/60

PANEL MOUNTING INCLINED SOCKETS EN 60309 - IP67 - 16A



ITEM	COLOUR	UM	DESCRIPTION	PACK-AGING
EC 69 402		PCS	2P- 20-25V	10/80
EC 69 403		PCS	3P- 20-25V	10/80
EC 69 104		PCS	2P+⊕-100-130V	10/80
EC 69 105		PCS	3P+⊕-100-130V	10/80
EC 69 051		PCS	2P+⊕-200-250V	10/80
EC 69 254		PCS	3P+⊕-200-250V	10/80
EC 69 255		PCS	3P+N+⊕-208-250V	10/60
EC 69 053		PCS	3P+⊕-380-415V	10/80
EC 69 055		PCS	3P+N+⊕-346-415V	10/60

PANEL MOUNTING INCLINED SOCKETS EN 60309 - IP67 - 32A

EC 69 106		PCS	2P+⊕-100-130V	10/80
EC 69 107		PCS	3P+⊕-100-130V	10/60
EC 69 256		PCS	2P+⊕-200-250V	10/80
EC 69 257		PCS	3P+⊕-200-250V	10/60
EC 69 058		PCS	3P+⊕-380-415V	10/40
EC 69 059		PCS	3P+N+⊕-346-415V	10/40

ITEM	COLOUR	UM	DESCRIPTION	PACK-AGING
------	--------	----	-------------	------------

PANEL MOUNTING INCLINED SOCKETS EN 60309 - IP67 - 63A



EC 69 258		PCS	2P+⊕-200-250V	2/16
EC 69 259		PCS	3P+⊕-200-250V	2/16
EC 69 350		PCS	3P+⊕-380-415V	2/16
EC 69 351		PCS	3P+N+⊕-346-415V	2/16

ITEM	COLOUR	UM	DESCRIPTION	PACK-AGING
------	--------	----	-------------	------------

PANEL MOUNTING INCLINED SOCKETS EN 60309 - IP67 - 125A



EC 69 651		PCS	2P+⊕-200-250V	2/8
EC 69 654		PCS	3P+⊕-200-250V	2/8
EC 69 653		PCS	3P+⊕-380-415V	2/8
EC 69 655		PCS	3P+N+⊕-346-415V	2/8

PANEL MOUNTING SOCKETS FLANGE 60x60 mm - IP55



EC 69 056	GC	PCS	2P+⊕ schuko/italian P17	1/30
EC 69 056F	GC	PCS	2P+⊕ french	1/30
EC 69 057	GC	PCS	empty for gw type	1/30

PANEL MOUNTING SOCKETS FLANGE 50x50 mm - IP54



EC 69 0514		PCS	2P+⊕ 16A french standard	100
EC 69 0515		PCS	2P+⊕ 16A german standard	100

(Co-moulded gasket)

PANEL MOUNTING FLANGE 60x60 mm WITH HATCH - IP55



EC L4611Q	GC	PCS	empty for 2 MyLIFE type electrical device	1/30
-----------	----	-----	---	------

ADDITIONAL GASKET

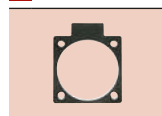

EC 202405		PCS	additional gasket for 50x50 mm sockets	50
-----------	--	-----	--	----

ITEM	COLOUR	UM	DESCRIPTION	PACK-AGING
------	--------	----	-------------	------------

WALL MOUNTING INCLINED BOX SOCKETS - IP44

	EC 69 4001		PCS 2P-20-25V-16A	12
	EC 69 4011		PCS 3P-20-25V-16A	12
	EC 69 1001		PCS 2P+⊕100-130V-16A	12
	EC 69 1011		PCS 3P+⊕100-130V-16A	12
	EC 69 0501		PCS 2P+⊕200-250V-16A	12
	EC 69 2501		PCS 3P+⊕200-250V-16A	12
	EC 69 0521		PCS 3P+⊕380-415V-16A	12
	EC 69 0541		PCS 3P+N+⊕346-415V-16A	12
	EC 69 1021		PCS 2P+⊕100-130V-32A	12
	EC 69 1031		PCS 3P+⊕100-130V-32A	12
	EC 69 2521		PCS 2P+⊕200-250V-32A	12
	EC 69 2531		PCS 3P+⊕200-250V-32A	12
	EC 69 0561		PCS 3P+⊕380-415V-32A	12
	EC 69 0581		PCS 3P+N+⊕346-415V-32A	12

ITEM	COLOUR	UM	DESCRIPTION	PACK-AGING
------	--------	----	-------------	------------

WALL MOUNTING INCLINED BOX SOCKETS - IP67

	EC 69 4021		PCS 2P-20-25V-16A	12
	EC 69 4031		PCS 3P-20-25V-16A	12
	EC 69 1041		PCS 2P+⊕100-130V-16A	12
	EC 69 1051		PCS 3P+⊕100-130V-16A	12
	EC 69 0511		PCS 2P+T⊕200-250V-16A	12
	EC 69 2541		PCS 3P+⊕200-250V-16A	12
	EC 69 0531		PCS 3P+⊕380-415V-16A	12
	EC 69 0551		PCS 3P+N+⊕346-415V-16A	12
	EC 69 1061		PCS 2P+⊕100-130V-32A	12
	EC 69 1071		PCS 3P+⊕100-130V-32A	12
	EC 69 2561		PCS 2P+⊕200-250V-32A	12
	EC 69 2571		PCS 3P+⊕200-250V-32A	12
	EC 69 0571		PCS 3P+⊕380-415V-32A	12
	EC 69 0591		PCS 3P+N+⊕346-415V-32A	12
	EC 69 2581		PCS 2P+⊕200-250V-63A	2
	EC 69 2591		PCS 3P+⊕200-250V-63A	2
	EC 69 3501		PCS 3P+⊕380-415V-63A	2
	EC 69 3511		PCS 3P+N+⊕346-415V-63A	2

WALL MOUNTING STRAIGHT BOX SOCKETS - IP44

	EC 69 4001D		PCS 2P-20-25V-16A	12
	EC 69 4011D		PCS 3P-20-25V-16A	12
	EC 69 1001D		PCS 2P+⊕100-130V-16A	12
	EC 69 1011D		PCS 3P+⊕100-130V-16A	12
	EC 69 0501D		PCS 2P+⊕200-250V-16A	12
	EC 69 2501D		PCS 3P+⊕200-250V-16A	12
	EC 69 0521D		PCS 3P+⊕380-415V-16A	12
	EC 69 0541D		PCS 3P+N+⊕346-415V-16A	12
	EC 69 1021D		PCS 2P+⊕100-130V-32A	12
	EC 69 1031D		PCS 3P+⊕100-130V-32A	12
	EC 69 2521D		PCS 2P+⊕200-250V-32A	12
	EC 69 2531D		PCS 3P+⊕200-250V-32A	12
	EC 69 0561D		PCS 3P+⊕380-415V-32A	12
	EC 69 0581D		PCS 3P+N+⊕346-415V-32A	12

WALL MOUNTING STRAIGHT BOX SOCKETS - IP67

	EC 69 4021D		PCS 2P-20-25V-16A	12
	EC 69 4031D		PCS 3P-20-25V-16A	12
	EC 69 1041D		PCS 2P+⊕100-130V-16A	12
	EC 69 1051D		PCS 3P+⊕100-130V-16A	12
	EC 69 0511D		PCS 2P+⊕200-250V-16A	12
	EC 69 2541D		PCS 3P+⊕200-250V-16A	12
	EC 69 0531D		PCS 3P+⊕380-415V-16A	12
	EC 69 0551D		PCS 3P+N+⊕346-415V-16A	12
	EC 69 1061D		PCS 2P+⊕100-130V-32A	12
	EC 69 1071D		PCS 3P+⊕100-130V-32A	12
	EC 69 2561D		PCS 2P+⊕200-250V-32A	12
	EC 69 2571D		PCS 3P+⊕200-250V-32A	12
	EC 69 0571D		PCS 3P+⊕380-415V-32A	12
	EC 69 0591D		PCS 3P+N+⊕346-415V-32A	12

WALL MOUNTING INCLINED BOX PLUGS - IP44

	EC 69 0701		PCS 2P+⊕200-250V-16A	10/40
	EC 69 0721		PCS 3P+⊕380-415V-16A	10/40
	EC 69 0741		PCS 3P+N+⊕346-415V-16A	10/40
	EC 69 2721		PCS 2P+⊕200-250V-32A	10/40
	EC 69 0761		PCS 3P+⊕380-415V-32A	10/40
	EC 69 0781		PCS 3P+N+⊕346-415V-32A	10/40

WALL MOUNTING INCLINED BOX PLUGS - IP67

	EC 69 0711		PCS 2P+⊕200-250V-16A	5/30
	EC 69 0731		PCS 3P+⊕380-415V-16A	5/30
	EC 69 0751		PCS 3P+N+⊕346-415V-16A	5/30
	EC 69 2761		PCS 2P+⊕200-250V-32A	5/30
	EC 69 0771		PCS 3P+⊕380-415V-32A	5/30
	EC 69 0791		PCS 3P+N+⊕346-415V-32A	5/30

PHASE INVERTER PLUG - IP44

	EC 69 072P		PCS 3P+⊕380-415V-16A	10
	EC 69 074P		PCS 3P+N+⊕346-415V-16A	10
	EC 69 076P		PCS 3P+⊕380-415V-32A	10
	EC 69 078P		PCS 3P+N+⊕346-415V-32A	10

PHASE INVERTER PLUG - IP67

	EC 69 073P		PCS 3P+⊕380-415V-16A	10
	EC 69 075P		PCS 3P+N+⊕346-415V-16A	10
	EC 69 077P		PCS 3P+⊕380-415V-32A	10
	EC 69 079P		PCS 3P+N+⊕346-415V-32A	10

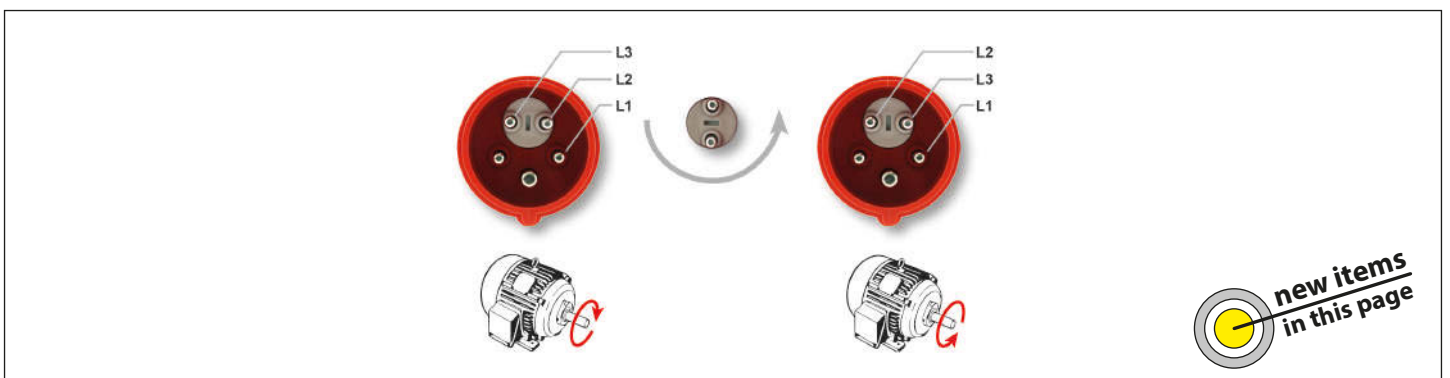

PANEL MOUNTING INTERLOCKED HORIZONTAL SOCKETS - IP44 - 16A



ITEM	COLOUR	UM	DESCRIPTION	PACK-AGING
EC 69 190		PCS	2P+⊕-100-130V	1/24
EC 69 090		PCS	2P+⊕-100-130V	1/24
EC 69 290		PCS	3P+⊕-200-250V	1/24
EC 69 092		PCS	3P+⊕-380-415V	1/24
EC 69 094		PCS	3P+N+⊕-346-415V	1/24

IP44 - 32A

EC 69 292		PCS	2P+⊕-200-250V	1/24
EC 69 293		PCS	3P+⊕-200-250V	1/24
EC 69 096		PCS	3P+⊕-380-415V	1/24
EC 69 098		PCS	3P+N+⊕-346-415V	1/24

PANEL MOUNTING INTERLOCKED HORIZONTAL SOCKETS - IP65 - 16A



ITEM	COLOUR	UM	DESCRIPTION	PACK-AGING
EC 69 194		PCS	2P+⊕-100-130V	1/24
EC 69 091		PCS	2P+⊕-200-250V	1/24
EC 69 294		PCS	3P+⊕-200-250V	1/24
EC 69 093		PCS	3P+⊕-380-415V	1/24
EC 69 095		PCS	3P+N+⊕-346-415V	1/24

IP65 - 32A

EC 69 296		PCS	2P+⊕-200-250V	1/24
EC 69 297		PCS	3P+⊕-200-250V	1/24
EC 69 097		PCS	3P+⊕-380-415V	1/24
EC 69 099		PCS	3P+N+⊕-346-415V	1/24

ITEM	COLOUR	UM	DESCRIPTION	PACK-AGING
------	--------	----	-------------	------------

WALL MOUNTING INTERLOCKED HORIZONTAL SOCKETS - IP44 - 16A



EC 69 1901		PCS	2P+⊕-100-130V	1/24
EC 69 0901		PCS	2P+⊕-200-250V	1/24
EC 69 2901		PCS	3P+⊕-200-250V	1/24
EC 69 0921		PCS	3P+⊕-380-415V	1/24
EC 69 0941		PCS	3P+N+⊕-346-415V	1/24

WALL MOUNTING INTERLOCKED HORIZONTAL SOCKETS - IP44 - 32A

EC 69 2921		PCS	2P+⊕-200-250V	1/24
EC 69 2931		PCS	3P+⊕-200-250V	1/24
EC 69 0961		PCS	3P+⊕-380-415V	1/24
EC 69 0981		PCS	3P+N+⊕-346-415V	1/24

ITEM	COLOUR	UM	DESCRIPTION	PACK-AGING
------	--------	----	-------------	------------

WALL MOUNTING INTERLOCKED HORIZONTAL SOCKETS - IP65 - 16A



EC 69 1941		PCS	2P+⊕-100-130V	1/24
EC 69 0911		PCS	2P+⊕-200-250V	1/24
EC 69 2941		PCS	3P+⊕-200-250V	1/24
EC 69 0931		PCS	3P+⊕-380-415V	1/24
EC 69 0951		PCS	3P+N+⊕-346-415V	1/24

WALL MOUNTING INTERLOCKED HORIZONTAL SOCKETS - IP65 - 32A

EC 69 2961		PCS	2P+⊕-200-250V	1/24
EC 69 2971		PCS	3P+⊕-200-250V	1/24
EC 69 0971		PCS	3P+⊕-380-415V	1/24
EC 69 0991		PCS	3P+N+⊕-346-415V	1/24

ITEM	COLOUR	UM	DESCRIPTION	PACK-AGING
------	--------	----	-------------	------------

WALL MOUNTING BOX



EC 69 0900 GC PCS wall mounting 154x144x50 1/20

ITEM	COLOUR	UM	DESCRIPTION	PACK-AGING
------	--------	----	-------------	------------

FLUSH MOUNTING BOX



EC 69 0910 GC PCS flush mounting 1/12

PANEL MOUNTING INTERLOCKED VERTICAL SOCKETS - IP44 - 16A



ITEM	COLOUR	UM	DESCRIPTION	PACK-AGING
EC 69 1904	Yellow	PCS	2P+⊕-100-130V	1/10
EC 69 0904	Blue	PCS	2P+⊕-200-250V	1/10
EC 69 2904	Blue	PCS	3P+⊕-200-250V	1/10
EC 69 0924	Red	PCS	3P+⊕-380-415V	1/10
EC 69 0944	Red	PCS	3P+N+⊕-346-415V	1/10

IP44 - 32A

EC 69 2924	Blue	PCS	2P+⊕-200-250V	1/10
EC 69 2934	Blue	PCS	3P+⊕-200-250V	1/10
EC 69 0964	Red	PCS	3P+⊕-380-415V	1/10
EC 69 0984	Red	PCS	3P+N+⊕-346-415V	1/10

PANEL MOUNTING INTERLOCKED VERTICAL SOCKETS - IP65 - 16A



ITEM	COLOUR	UM	DESCRIPTION	PACK-AGING
EC 69 1944	Yellow	PCS	2P+⊕-100-130V	1/10
EC 69 0914	Blue	PCS	2P+⊕-200-250V	1/10
EC 69 2944	Blue	PCS	3P+⊕-200-250V	1/10
EC 69 0934	Red	PCS	3P+⊕-380-415V	1/10
EC 69 0954	Red	PCS	3P+N+⊕-346-415V	1/10

IP65 - 32A

EC 69 2964	Blue	PCS	2P+⊕-200-250V	1/10
EC 69 2974	Blue	PCS	3P+⊕-200-250V	1/10
EC 69 0974	Red	PCS	3P+⊕-380-415V	1/10
EC 69 0994	Red	PCS	3P+N+⊕-346-415V	1/10

IP65 - 63A

EC 69 2584	Blue	PCS	2P+⊕-200-250V	1/10
EC 69 2594	Blue	PCS	3P+⊕-200-250V	1/10
EC 69 3504	Red	PCS	3P+⊕-380-415V	1/10
EC 69 3514	Red	PCS	3P+N+⊕-346-415V	1/10

ITEM	COLOUR	UM	DESCRIPTION	PACK-AGING
------	--------	----	-------------	------------

WALL MOUNTING INTERLOCKED VERTICAL SOCKETS - IP44 - 16A



EC 69 19041	Yellow	PCS	2P+⊕-100-130V	1/10
EC 69 09041	Blue	PCS	2P+⊕-200-250V	1/10
EC 69 29041	Blue	PCS	3P+⊕-200-250V	1/10
EC 69 09241	Red	PCS	3P+⊕-380-415V	1/10
EC 69 09441	Red	PCS	3P+N+⊕-346-415V	1/10

WALL MOUNTING INTERLOCKED VERTICAL SOCKETS - IP44 - 32A

EC 69 29241	Blue	PCS	2P+⊕-200-250V	1/10
EC 69 29341	Blue	PCS	3P+⊕-200-250V	1/10
EC 69 09641	Red	PCS	3P+⊕-380-415V	1/10
EC 69 09841	Red	PCS	3P+N+⊕-346-415V	1/10

ITEM	COLOUR	UM	DESCRIPTION	PACK-AGING
------	--------	----	-------------	------------

MODULAR WALL MOUNTING BOX FOR INTERLOCKED VERTICAL SOCKETS



EC 69 09014	GC	PCS	1 socket	1/10
EC 69 09024	GC	PCS	2 sockets	1/5
EC 69 09034	GC	PCS	3 sockets	1/3
EC 69 09044	GC	PCS	4 sockets	1/2

ITEM	COLOUR	UM	DESCRIPTION	PACK-AGING
------	--------	----	-------------	------------

WALL MOUNTING INTERLOCKED VERTICAL SOCKETS - IP65 - 16A



EC 69 19441	Yellow	PCS	2P+⊕-100-130V	1/10
EC 69 09141	Blue	PCS	2P+⊕-200-250V	1/10
EC 69 29441	Blue	PCS	3P+⊕-200-250V	1/10
EC 69 09341	Red	PCS	3P+⊕-380-415V	1/10
EC 69 09541	Red	PCS	3P+N+⊕-346-415V	1/10

WALL MOUNTING INTERLOCKED VERTICAL SOCKETS - IP65 - 32A

EC 69 29641	Blue	PCS	2P+⊕-200-250V	1/10
EC 69 29741	Blue	PCS	3P+⊕-200-250V	1/10
EC 69 09741	Red	PCS	3P+⊕-380-415V	1/10
EC 69 09941	Red	PCS	3P+N+⊕-346-415V	1/10

WALL MOUNTING INTERLOCKED VERTICAL SOCKETS - IP65 - 63A

EC 69 25841	Blue	PCS	2P+⊕-200-250V	1/10
EC 69 25941	Blue	PCS	3P+⊕-200-250V	1/10
EC 69 35041	Red	PCS	3P+⊕-380-415V	1/10
EC 69 35141	Red	PCS	3P+N+⊕-346-415V	1/10

2-WAY MULTIPLIER - EN 60309 PLUG - 16A



ITEM	COLOUR	UM	DESCRIPTION	PACK-AGING
EC 69 1702	Yellow	PCS	2P+⊕-100-130V-IP44	10
EC 69 0702	Blue	PCS	2P+⊕-200+250V-IP44	10
EC 69 0722	Red	PCS	3P+⊕-380-415V-IP44	10
EC 69 1742	Yellow	PCS	2P+⊕-100-130V-IP67	5
EC 69 0712	Blue	PCS	2P+⊕-200-250V-IP67	5
EC 69 0732	Red	PCS	3P+⊕-380V-IP67	5

3-WAY MULTIPLIER - EN 60309 PLUG - 16A



ITEM	COLOUR	UM	DESCRIPTION	PACK-AGING
EC 69 1703	Yellow	PCS	2P+⊕-100-130V-IP44	6
EC 69 0703	Blue	PCS	2P+⊕-200-250V-IP44	5
EC 69 2703	Blue	PCS	3P+⊕-200-250V-IP44	4
EC 69 2713	Blue	PCS	3P+N+⊕-208-250V-IP44	4
EC 69 0723	Red	PCS	3P+⊕-380-415V-IP44	4
EC 69 0743	Red	PCS	3P+N+⊕-346-415V-IP44	4
EC 69 1743	Yellow	PCS	2P+⊕-100-130V-IP67	6
EC 69 0713	Blue	PCS	2P+⊕-200-250V-IP67	5
EC 69 2743	Blue	PCS	3P+⊕-200-250V-IP67	4
EC 69 2753	Blue	PCS	3P+N+⊕-208-250V-IP67	4
EC 69 0733	Red	PCS	3P+⊕-380-415V-IP67	4
EC 69 0753	Red	PCS	3P+N+⊕-346-415V-IP67	4

3-WAY MULTIPLIER - EN 60309 PLUG - 32A

EC 69 0763	Red	PCS	3P+⊕-380-415V-IP44	4
EC 69 0783	Red	PCS	3P+N+⊕-346-415V-IP44	4
EC 69 0773	Red	PCS	3P+⊕-380-415V-IP67	4
EC 69 0793	Red	PCS	3P+N+⊕-346-415V-IP67	4

INDUSTRIAL EXTENSIONS PLUG AND SOCKET EN 60309 - 16A - IP44



ITEM	COLOUR	UM	DESCRIPTION	PACK-AGING
EC 699P10	Blue	PCS	2P-10 MT - 3x2,5	1
EC 699P11	Red	PCS	3P-10 MT - 4x2,5	1
EC 699P12	Red	PCS	3P+N-10 MT - 5x2,5	1
EC 699P13	Blue	PCS	2P-20 MT - 3x2,5	1
EC 699P14	Red	PCS	3P-20 MT - 4x2,5	1
EC 699P15	Red	PCS	3P+N-20 MT - 5x2,5	1
EC 699P16	Blue	PCS	2P-30 MT - 3x2,5	1
EC 699P17	Red	PCS	3P-30 MT - 4x2,5	1
EC 699P18	Red	PCS	3P+N-30 MT - 5x2,5	1

INDUSTRIAL EXTENSIONS PLUG AND SOCKET EN 60309 - 16A - IP67



ITEM	COLOUR	UM	DESCRIPTION	PACK-AGING
EC 699P20	Blue	PCS	2P-10 MT - 3x2,5	1
EC 699P21	Red	PCS	3P-10 MT - 4x2,5	1
EC 699P22	Red	PCS	3P+N-10 MT - 5x2,5	1
EC 699P23	Blue	PCS	2P-20 MT - 3x2,5	1
EC 699P24	Red	PCS	3P-20 MT - 4x2,5	1
EC 699P25	Red	PCS	3P+N-20 MT - 5x2,5	1
EC 699P26	Blue	PCS	2P-30 MT - 3x2,5	1
EC 699P27	Red	PCS	3P-30 MT - 4x2,5	1
EC 699P28	Red	PCS	3P+N-30 MT - 5x2,5	1

3-WAY MULTIPLIER - WITH CABLE - 16A - IP67



EC 69 0714-3	Blue	PCS	2P+⊕-220V-3MT	1
EC 69 0714-20	Blue	PCS	2P+⊕-220V-20MT	1
EC 69 0714-30	Blue	PCS	2P+⊕-220V-30MT	1

3-WAY MULTIPLIER - WITH CABLE - 16A - IP67



EC 69 0754-3	Red	PCS	3P+N+⊕-380V-3MT	1
--------------	-----	-----	-----------------	---









ITEM	COLOUR	UM	DESCRIPTION	PACK-AGING
ADAPTOR INDUSTRIAL TO DOMESTIC SOCKET - 16A				

EC 69 0510	GC	PCS	2P-220V → schuko+2 italian P17	10/80
EC 69 0530	GC	PCS	3P+N-380V → schuko/italian P17	10/90
EC 69 0540	GC	PCS	3P+N-380V → 2 italian P17	10/90

ITEM	COLOUR	UM	DESCRIPTION	PACK-AGING
ADAPTOR DOMESTIC TO INDUSTRIAL SOCKET - 16A				

EC 69 0512	GC	PCS	schuko plug	10/80
EC 69 0513	GC	PCS	italian S17 plug	10/80

WALL MOUNTING EMERGENCY PUSH-BUTTONS

	ITEM	COLOUR	UM	DESCRIPTION	PACK-AGING
	EC 69000E	G	PCS	Ø 40 - twist to release IP65 - Contact NC 10A - 250V~	1/12
	EC 69000ES	G	PCS	Ø 40 - twist to release with vision red/ green IP65 - Contact NC 10A - 250V~	1/12
	EC 69003E	G	PCS	Ø 40 - push-pull IP65 - Contact NC 10A - 250V~	1/12
	EC 69003EL	G	PCS	Ø 40 - push-pull with lens cap IP65 - Contact NC 10A - 250V~	1/12
	EC 69007E	G	PCS	Ø 40 - with key release IP65 - Contact NC 10A - 250V~	1/12
	EC 69060E	G	PCS	Ø 60 - twist to release IP65 - Contact NC 10A - 250V~	1/12
	EC 69063E	G	PCS	Ø 60 - push-pull IP65 - Contact NC 10A - 250V~	1/12
	EC 69063E-N	G	PCS	Ø 60 - push-pull-black IP65 - Contact NC 10A - 250V~	1/12



IP65 SAFETY SWITCHES - TECHNOPOLYMER BOX



ITEM	COLOUR	UM	DESCRIPTION	PACK-AGING
EC 660162E	GC	PCS	16A - 2P - 115x155x105	1/24
EC 660163E	GC	PCS	16A - 3P - 115x155x105	1/24
EC 660164E	GC	PCS	16A - 4P - 115x155x105	1/24
EC 660202E	GC	PCS	20A - 2P - 115x155x105	1/24
EC 660203E	GC	PCS	20A - 3P - 115x155x105	1/24
EC 660204E	GC	PCS	20A - 4P - 115x155x105	1/24
EC 660322E	GC	PCS	32A - 2P - 115x155x105	1/24
EC 660323E	GC	PCS	32A - 3P - 115x155x105	1/24
EC 660324E	GC	PCS	32A - 4P - 115x155x105	1/24
EC 660402E	GC	PCS	40A - 2P - 115x155x105	1/24
EC 660403E	GC	PCS	40A - 3P - 115x155x105	1/24
EC 660404E	GC	PCS	40A - 4P - 115x155x105	1/24
EC 660632E	GC	PCS	63A - 2P - 155x205x125	1/10
EC 660633E	GC	PCS	63A - 3P - 155x205x125	1/10
EC 660634E	GC	PCS	63A - 4P - 155x205x125	1/10
EC 660802E	GC	PCS	80A - 2P - 155x205x125	1/10
EC 660803E	GC	PCS	80A - 3P - 155x205x125	1/10
EC 660804E	GC	PCS	80A - 4P - 155x205x125	1/10
EC 661003E	GC	PCS	100A - 3P - 155x205x125	1/10
EC 661004E	GC	PCS	100A - 4P - 155x205x125	1/10

IP65 CONTROL SWITCHES - TECHNOPOLYMER BOX



ITEM	COLOUR	UM	DESCRIPTION	PACK-AGING
EC 660162M	GC	PCS	16A - 2P - 115x155x105	1/24
EC 660163M	GC	PCS	16A - 3P - 115x155x105	1/24
EC 660164M	GC	PCS	16A - 4P - 115x155x105	1/24
EC 660202M	GC	PCS	20A - 2P - 115x155x105	1/24
EC 660203M	GC	PCS	20A - 3P - 115x155x105	1/24
EC 660204M	GC	PCS	20A - 4P - 115x155x105	1/24
EC 660322M	GC	PCS	32A - 2P - 115x155x105	1/24
EC 660323M	GC	PCS	32A - 3P - 115x155x105	1/24
EC 660324M	GC	PCS	32A - 4P - 115x155x105	1/24
EC 660402M	GC	PCS	40A - 2P - 115x155x105	1/24
EC 660403M	GC	PCS	40A - 3P - 115x155x105	1/24
EC 660404M	GC	PCS	40A - 4P - 115x155x105	1/24
EC 660632M	GC	PCS	63A - 2P - 155x205x125	1/10
EC 660633M	GC	PCS	63A - 3P - 155x205x125	1/10
EC 660634M	GC	PCS	63A - 4P - 155x205x125	1/10
EC 660802M	GC	PCS	80A - 2P - 155x205x125	1/10
EC 660803M	GC	PCS	80A - 3P - 155x205x125	1/10
EC 660804M	GC	PCS	80A - 4P - 155x205x125	1/10
EC 661003M	GC	PCS	100A - 3P - 155x205x125	1/10
EC 661004M	GC	PCS	100A - 4P - 155x205x125	1/10

IP65 PANEL MOUNTING SAFETY SWITCHES



ITEM	COLOUR	UM	DESCRIPTION	PACK-AGING
EC 660162EI	GC	PCS	16A - 2P - 74x85x88	1/12
EC 660163EI	GC	PCS	16A - 3P - 74x85x88	1/12
EC 660164EI	GC	PCS	16A - 4P - 74x85x88	1/12
EC 660202EI	GC	PCS	20A - 2P - 74x85x88	1/12
EC 660203EI	GC	PCS	20A - 3P - 74x85x88	1/12
EC 660204EI	GC	PCS	20A - 4P - 74x85x88	1/12
EC 660322EI	GC	PCS	32A - 2P - 74x85x88	1/12
EC 660323EI	GC	PCS	32A - 3P - 74x85x88	1/12
EC 660324EI	GC	PCS	32A - 4P - 74x85x88	1/12
EC 660402EI	GC	PCS	40A - 2P - 74x85x88	1/12
EC 660403EI	GC	PCS	40A - 3P - 74x85x88	1/12
EC 660404EI	GC	PCS	40A - 4P - 74x85x88	1/12

IP65 PANEL MOUNTING CONTROL SWITCHES



ITEM	COLOUR	UM	DESCRIPTION	PACK-AGING
EC 660162MI	GC	PCS	16A - 2P - 74x85x88	1/12
EC 660163MI	GC	PCS	16A - 3P - 74x85x88	1/12
EC 660164MI	GC	PCS	16A - 4P - 74x85x88	1/12
EC 660202MI	GC	PCS	20A - 2P - 74x85x88	1/12
EC 660203MI	GC	PCS	20A - 3P - 74x85x88	1/12
EC 660204MI	GC	PCS	20A - 4P - 74x85x88	1/12
EC 660322MI	GC	PCS	32A - 2P - 74x85x88	1/12
EC 660323MI	GC	PCS	32A - 3P - 74x85x88	1/12
EC 660324MI	GC	PCS	32A - 4P - 74x85x88	1/12
EC 660402MI	GC	PCS	40A - 2P - 74x85x88	1/12
EC 660403MI	GC	PCS	40A - 3P - 74x85x88	1/12
EC 660404MI	GC	PCS	40A - 4P - 74x85x88	1/12

MOUNTING EXAMPLES



**new items
in this page**

EMPTY DISTRIBUTION BOARDS - 4 MODULES - 2 SOCKETS



ITEM	COLOUR	UM	DESCRIPTION	PACK-AGING
EC 69001	GC	PCS	blank	1/15
EC 69011	GC	PCS	pre-cut for sockets 16/32A	1/15
EC 69021	GC	PCS	flanged for EC sockets 16A	1/15

EMPTY DISTRIBUTION BOARDS - 4 MODULES - 3 SOCKETS



ITEM	COLOUR	UM	DESCRIPTION	PACK-AGING
EC 69002	GC	PCS	blank	1/13
EC 69012	GC	PCS	pre-cut for sockets 16/32A	1/13
EC 69022	GC	PCS	flanged for EC sockets 16A	1/13

EMPTY DISTRIBUTION BOARDS - 8 MODULES - 4 SOCKETS



ITEM	COLOUR	UM	DESCRIPTION	PACK-AGING
EC 69003	GC	PCS	blank	1
EC 69013	GC	PCS	pre-cut for sockets 16/32A	1
EC 69023	GC	PCS	flanged for EC sockets 16A	1

EMPTY DISTRIBUTION BOARDS - 12 MODULES - 3 SOCKETS



ITEM	COLOUR	UM	DESCRIPTION	PACK-AGING
EC 69004	GC	PCS	blank	1
EC 69014	GC	PCS	pre-cut for sockets 16/32A	1
EC 69024	GC	PCS	flanged for EC sockets 16A	1
EC 69034	GC	PCS	for 2 EC interlocked hor. sockets WOFH	1

EMPTY DISTRIBUTION BOARDS - 12 MODULES - 6 SOCKETS



ITEM	COLOUR	UM	DESCRIPTION	PACK-AGING
EC 69005	GC	PCS	blank	1
EC 69015	GC	PCS	pre-cut for sockets 16/32A	1
EC 69025	GC	PCS	flanged for EC sockets 16A	1
EC 69035	GC	PCS	for 4 EC interlocked hor. sockets WOFH	1
EC 69045	GC	PCS	for 2 EC interlocked vertical sockets	1

EMPTY DISTRIBUTION BOARDS - 19 MODULES - 8 SOCKETS

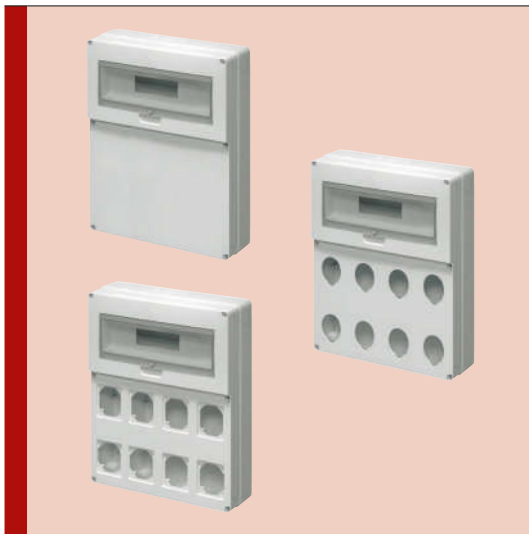

ITEM	COLOUR	UM	DESCRIPTION	PACK-AGING
EC 69006	GC	PCS	blank	1
EC 69016	GC	PCS	pre-cut for sockets 16/32A	1
EC 69026	GC	PCS	flanged for EC sockets 16A	1
EC 69036	GC	PCS	for 4 EC interlocked hor. sockets WFH	1
EC 69046	GC	PCS	for 3 EC interlocked vertical sockets	1

ITEM	IP	UM	DESCRIPTION	PACK-AGING	ITEM	IP	UM	DESCRIPTION	PACK-AGING
------	----	----	-------------	------------	------	----	----	-------------	------------

CABLED EMERGENCY PUSH-BUTTON FOR ASC BOARDS



-E		PCS	push-button	1
-----------	--	-----	-------------	---

METALLIC SUPPORT FOR DISTRIBUTION BOARDS



EC 69040		PCS	for 8 modules with cable support	1
EC 69041		PCS	for 12-19 modules with cable support	1
EC 69040T		PCS	for 8 modules with protection	1
EC 69041T		PCS	for 12 modules with protection	1

ITEM	COLOUR	UM	DESCRIPTION	PACK-AGING	ITEM	COLOUR	UM	DESCRIPTION	PACK-AGING
------	--------	----	-------------	------------	------	--------	----	-------------	------------



EC 52121	GC	PCS	joint - PG21 type	10/50
EC 52129	GC	PCS	joint - PG29 type	10/50
EC 52136	GC	PCS	joint - PG36 type	10/50



EC 690MA	GC	PCS	for all distribution boards	1/10
-----------------	----	-----	-----------------------------	------



EC 690F1	GC	PCS	sockets 16A	10
EC 690F2	GC	PCS	hor. interlocked s. 16/32A WOFH	10
EC 690F3	GC	PCS	ver. interlocked s. 16/32/63A WFH	10
EC 690F5	GC	PCS	hor. interlocked s. 16/32A WFH	10



EC 690F4	GC	PCS	for sockets 16/32A or flange 60x60 for boards 69045 and 69046	1/20
-----------------	----	-----	---	------

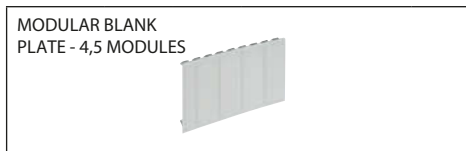

EC 600TC	GC	PCS	4,5 modules	25
-----------------	----	-----	-------------	----

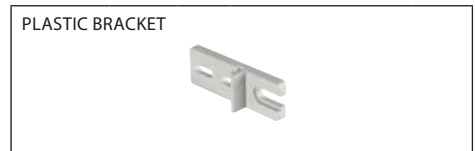

EC 600SF	GC	PCS	plastic bracket to keep IP-protection and double insulation - for all distribution boards series 690	50
-----------------	----	-----	--	----





EC 690F6	GC	PCS	for auxiliary controls Ø 22 mm	10
EC 690F7	GC	PCS	for panel mounting sockets centre hole distance 38x38 mm (EC690514-EC690515)	10





EC L4608	GC	PCS	2 modules DIN bar adapter for 2 MYLIFE electrical device	40
-----------------	----	-----	--	----

new items
in this page

ITEM	IP	UM	DESCRIPTION ALL SOCKETS ARE + ±	PACK- AGING	
DISTRIBUTION BOARDS DBO TYPE - 2 VERTICAL SOCKETS 16A					
	EC 6902120	44	PCS	1x2P - 1x3P	1
	EC 6902121	44	PCS	2x2P	1
	EC 6902122	44	PCS	1x2P - 1xbiv	1
	EC 6902123	44	PCS	2xbiv	1
	EC 6902124	65	PCS	2x3P	1
	EC 6902130	65	PCS	1x2P - 1x3P	1
	EC 6902131	65	PCS	2x2P	1
	EC 6902132	65	PCS	2x3P	1

ITEM	IP	UM	DESCRIPTION ALL SOCKETS ARE + ±	PACK- AGING	
DISTRIBUTION BOARDS ASC TYPE - 2 VERTICAL SOCKETS 16A					
	EC 6902100	44	PCS	1x2P - 1x3P	1
	EC 6902101	44	PCS	1x2P - 1xbiv	1
	EC 6902102	44	PCS	2x2P	1
	EC 6902103	44	PCS	2xbiv	1
	EC 6902104	65	PCS	2x3P	1
	EC 6902110	65	PCS	1x2P - 1x3P	1
	EC 6902111	65	PCS	2x2P	1
	EC 6902112	65	PCS	2x3P	1

ITEM	IP	UM	DESCRIPTION ALL SOCKETS ARE + ±	PACK- AGING	
DISTRIBUTION BOARDS DBO TYPE - 3 VERTICAL SOCKETS 16A					
	EC 6902220	44	PCS	2x2P - 1x3P	1
	EC 6902221	44	PCS	1x2P - 1x3P - 1x3P+N	1
	EC 6902222	44	PCS	2x2P - 1xbiv	1
	EC 6902223	44	PCS	1x2P - 2x3P	1
	EC 6902224	44	PCS	1x2P - 1x3P - 1xbiv	1
	EC 6902225	44	PCS	3x2P	1
	EC 6902226	44	PCS	3xbiv	1
	EC 6902227	44	PCS	3x3P	1
	EC 6902230	65	PCS	2x2P - 1x3P	1
	EC 6902231	65	PCS	1x2P - 2x3P	1
	EC 6902232	65	PCS	1x2P - 1x3P - 1x3P+N	1
	EC 6902233	65	PCS	3x2P	1
	EC 6902234	65	PCS	3x3P	1

ITEM	IP	UM	DESCRIPTION ALL SOCKETS ARE + ±	PACK- AGING	
DISTRIBUTION BOARDS ASC TYPE - 3 VERTICAL SOCKETS 16A					
	EC 6902200	44	PCS	2x2P - 1x3P	1
	EC 6902201	44	PCS	1x2P - 1x3P - 1x3P+N	1
	EC 6902202	44	PCS	2x2P - 1xbiv	1
	EC 6902203	44	PCS	1x2P - 2x3P	1
	EC 6902204	44	PCS	1x2P - 1x3P - 1xbiv	1
	EC 6902205	44	PCS	3x2P	1
	EC 6902206	44	PCS	3x3P	1
	EC 6902207	44	PCS	3xbiv	1
	EC 6902210	65	PCS	2x2P - 1x3P	1
	EC 6902211	65	PCS	1x2P - 2x3P	1
	EC 6902212	65	PCS	1x2P - 1x3P - 1x3P+N	1
	EC 6902213	65	PCS	3x2P	1
	EC 6902214	65	PCS	3x3P	1

ITEM	IP	UM	DESCRIPTION ALL SOCKETS ARE + ±	PACK- AGING	
DISTRIBUTION BOARDS DBO TYPE - 3 VERTICAL SOCKETS 16A					
	EC 6902320	44	PCS	2x2P - 2x3P	1
	EC 6902321	44	PCS	2x2P - 1x3P - 1x3P+N	1
	EC 6902322	44	PCS	1x2P - 1x3P - 1x3P+N - 1xbiv	1
	EC 6902323	44	PCS	2x2P - 2xbiv	1
	EC 6902324	44	PCS	4x2P	1
	EC 6902325	44	PCS	4x3P	1
	EC 6902326	44	PCS	3x2P - 1x3P	1
	EC 6902330	65	PCS	2x2P - 2x3P	1
	EC 6902331	65	PCS	2x2P - 1x3P - 1x3P+N	1
	EC 6902332	65	PCS	1x2P - 2x3P - 1x3P+N	1
	EC 6902333	65	PCS	4x2P	1
	EC 6902334	65	PCS	4x3P	1
	EC 6902336	65	PCS	3x2P - 1x3P	1

ITEM	IP	UM	DESCRIPTION ALL SOCKETS ARE + ±	PACK- AGING	
DISTRIBUTION BOARDS ASC TYPE - 4 SOCKETS 16A					
	EC 6902300	44	PCS	2x2P - 2x3P	1
	EC 6902301	44	PCS	2x2P - 1x3P - 1x3P+N	1
	EC 6902302	44	PCS	1x2P - 1x3P - 1x3P+N - 1xbiv	1
	EC 6902303	44	PCS	2x2P - 2xbiv	1
	EC 6902304	44	PCS	4x2P	1
	EC 6902305	44	PCS	4x3P	1
	EC 6902308	44	PCS	3x2P - 1x3P	1
	EC 6902310	65	PCS	2x2P - 2x3P	1
	EC 6902311	65	PCS	2x2P - 1x3P - 1x3P+N	1
	EC 6902312	65	PCS	1x2P - 2x3P - 1x3P+N	1
	EC 6902313	65	PCS	4x2P	1
	EC 6902314	65	PCS	4x3P	1
	EC 6902318	65	PCS	3x2P - 1x3P	1

ITEM	IP	UM	DESCRIPTION ALL SOCKETS ARE + ±	PACK- AGING	
DISTRIBUTION BOARDS DBO TYPE - 3 HORIZONTAL SOCKETS 16A					
	EC 6902420	44	PCS		
	EC 6902421	44	PCS		
	EC 6902422	44	PCS		
	EC 6902423	44	PCS		
	EC 6902424	44	PCS		
	EC 6902425	44	PCS		
	EC 6902430	65	PCS		
	EC 6902431	65	PCS		
	EC 6902432	65	PCS		
	EC 6902433	65	PCS		
	EC 6902434	65	PCS		

ITEM	IP	UM	DESCRIPTION ALL SOCKETS ARE + ±	PACK- AGING	
DISTRIBUTION BOARDS ASC TYPE - 3 HORIZONTAL SOCKETS 16A					
	EC 6902400	44	PCS	2x2P - 1x3P	1
	EC 6902401	44	PCS	1x2P - 2x3P	1
	EC 6902402	44	PCS	1x2P - 1x3P - 1x3P+N	1
	EC 6902403	44	PCS	1x2P - 1x3P - 1xbiv	1
	EC 6902404	44	PCS	3x2P	1
	EC 6902405	44	PCS	3x3P	1
	EC 6902410	65	PCS	2x2P - 1x3P	1
	EC 6902411	65	PCS	1x2P - 2x3P	1
	EC 6902412	65	PCS	1x2P - 1x3P - 1x3P+N	1
	EC 6902413	65	PCS	3x2P	1
	EC 6902414	65	PCS	3x3P	1

ITEM	IP	UM	DESCRIPTION ALL SOCKETS ARE + ±	PACK- AGING	
DISTRIBUTION BOARDS DBO TYPE - 6 SOCKETS 16A					
	EC 6902520	44	PCS	3x2P - 3x3P	1
	EC 6902521	44	PCS	2x2P - 2x3P - 2x3P+N	1
	EC 6902522	44	PCS	2x2P - 2x3P - 1x3P+N - 1xbiv	1
	EC 6902523	44	PCS	2x2P - 1x3P - 1x3P+N - 2xbiv	1
	EC 6902524	44	PCS	6x2P	1
	EC 6902525	44	PCS	6x3P	1
	EC 6902530	65	PCS	3x2P - 3x3P	1
	EC 6902531	65	PCS	2x2P - 2x3P - 2x3P+N	1
	EC 6902532	65	PCS	3x2P - 2x3P - 1x3P+N	1
	EC 6902533	65	PCS	6x2P	1
	EC 6902534	65	PCS	6x3P	1
	EC 6902535	65	PCS	4x2P - 2x3P	1

ITEM	IP	UM	DESCRIPTION ALL SOCKETS ARE + ±	PACK- AGING	
DISTRIBUTION BOARDS ASC TYPE - 6 SOCKETS 16A					
	EC 6902500	44	PCS	3x2P - 3x3P	1
	EC 6902501	44	PCS	2x2P - 2x3P - 2x3P+N	1
	EC 6902502	44	PCS	2x2P - 2x3P - 1x3P+N - 1xbiv	1
	EC 6902503	44	PCS	2x2P - 1x3P - 1x3P+N - 2xbiv	1
	EC 6902504	44	PCS	6x2P	1
	EC 6902505	44	PCS	6x3P	1
	EC 6902510	65	PCS	3x2P - 3x3P	1
	EC 6902511	65	PCS	2x2P - 2x3P - 2x3P+N	1
	EC 6902512	65	PCS	3x2P - 2x3P - 1x3P+N	1
	EC 6902513	65	PCS	6x2P	1
	EC 6902514	65	PCS	6x3P	1
	EC 6902515	65	PCS	4x2P - 2x3P	1

ITEM	IP	UM	DESCRIPTION ALL SOCKETS ARE + ±	PACK- AGING	
DISTRIBUTION BOARDS DBO TYPE - 8 SOCKETS 16A					
	EC 6902620	44	PCS	8x2P	1
	EC 6902621	44	PCS	4x2P - 4x3P	1
	EC 6902622	44	PCS	4x2P - 4x3P+N	1
	EC 6902623	44	PCS	4x2P - 2x3P - 2x3P+N	1
	EC 6902630	65	PCS	8x2P	1
	EC 6902631	65	PCS	4x2P - 4x3P	1
	EC 6902632	65	PCS	4x2P - 4x3P+N	1
	EC 6902633	65	PCS	4x2P - 2x3P - 2x3P+N	1

ITEM	IP	UM	DESCRIPTION ALL SOCKETS ARE + ±	PACK- AGING	
DISTRIBUTION BOARDS ASC TYPE - 8 SOCKETS 16A					
	EC 6902600	44	PCS	8x2P	1
	EC 6902601	44	PCS	4x2P - 4x3P	1
	EC 6902602	44	PCS	4x2P - 4x3P+N	1
	EC 6902603	44	PCS	4x2P - 2x3P - 2x3P+N	1
	EC 6902610	65	PCS	8x2P	1
	EC 6902611	65	PCS	4x2P - 4x3P	1
	EC 6902612	65	PCS	4x2P - 4x3P+N	1
	EC 6902613	65	PCS	4x2P - 2x3P - 2x3P+N	1



SURFACE MOUNTING POLYESTER BOARDS

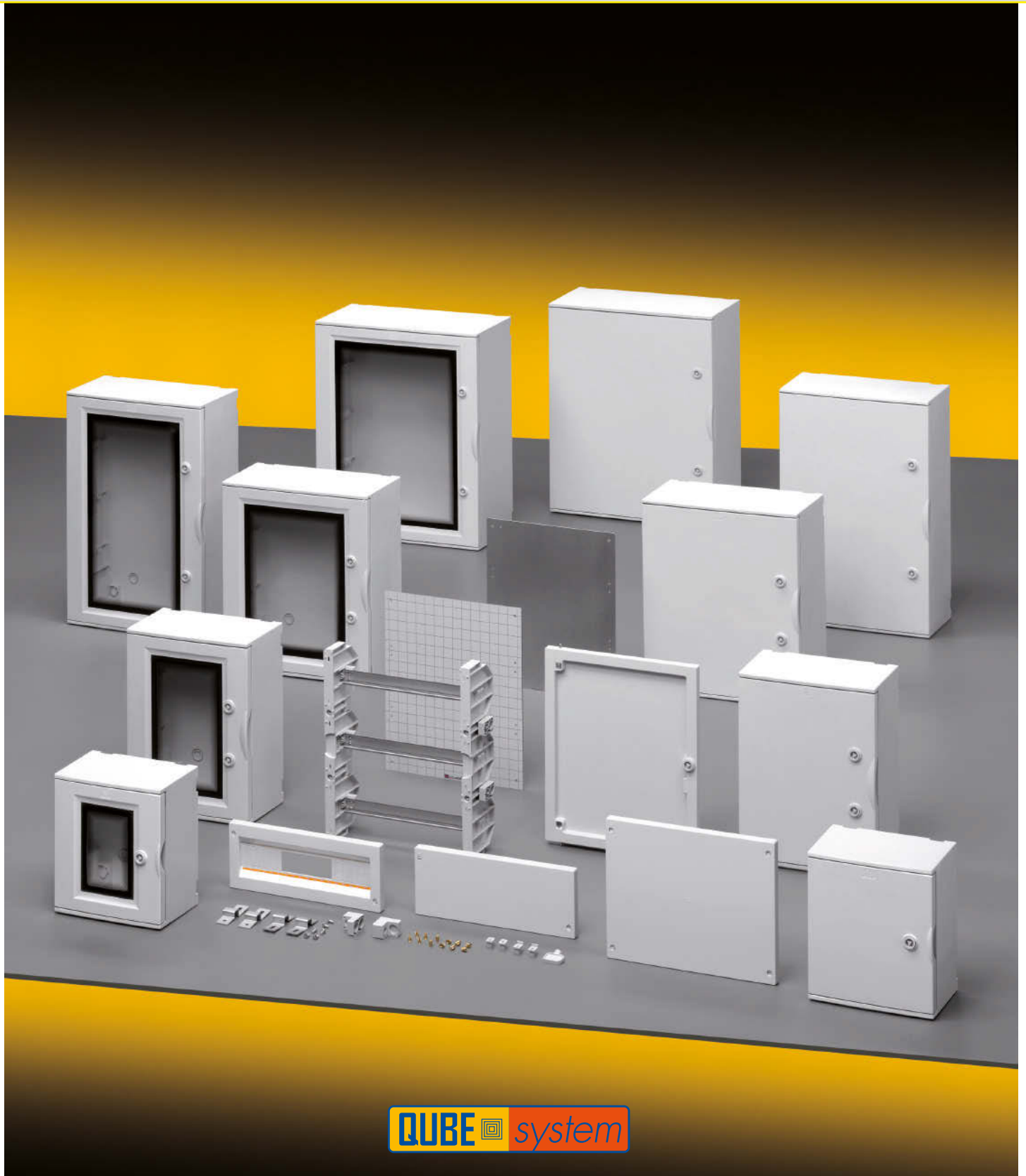

QUBE  *system*

IP65 WATERTIGHT SURFACE MOUNTING POLYESTER BOARDS

CONSTRUCTIVE TECHNICAL CHARACTERISTICS:

- IP65 protection degree, Color: grey RAL 7035.
- Material: made of halogen free reinforced fiberglass polyester, self-extinguishing HB degree to UL94.
- Double insulation, Shock resistance: IK10, 20j, to EN 62262.
- Application temperature: minimum -25°, maximum +70°.
- Resistance to abnormal heat (GWT)- board with blank door up to 960°C - board with transparent window up to 650°C.
- Application voltage 1000V, suitable for photovoltaic plants.
- Right or left reversible door with stainless steel pins – it can be opened at 180°.
- Plain and smooth headboards for easy opening and conduit inlet.
- Removable frame ready to install slotted trunkings in the back.
- Back plates made up of metal or insulating material can be fixed directly to the board back, also if the frame is used, or can be adjusted to different heights through the kit EC625REG.
- Possibility to mount 48-75mm high switches or 102mm high switches starting from the board with dimensions 435x505x215.
- One-Screw-System: only one type of screws is used for the different accessories in order to permit a simple and easy assembly.
- Left or right reversible counter door with stainless steel pins, ergonomic handle, triangle lock, adjustable at two different heights with reference grid for the fixing of the devices.
- Fixing of the single/double blank or windowed panels through a ¼ turn screws.

 WxHxD mm									
I° 270x305x170	625001	625011	-	625031	625041	-	-	-	-
II° 325x430x185 36M (12x3)	625002	625012	625022	625032	625042	625072	625102	625112	625122
III° 435x505x215 54M (18x3)	625003	625013	625023	625033	625043	625073	625103	625113	625123
IV° 435x655x215 72M (18x4)	625004	625014	625024	625034	625044	625074	625103	625113	625123
V° 545x655x265 96M (24x4)	625005	625015	625025	625035	625045	625074	625105	625115	625125
VI° 620x810x320 140M (28x5)	625006	625016	625026	625036	625046	625076	625106	625116	625126

 WxHxD mm									
I° 270x305x170	-	-	625SZ	625SI	-	625SC	-	625GI	625SP1
II° 325x430x185 36M (12x3)	625132 (12M)	625REG	625SZ	625SI	600TC	625SC	625IO	625GI	625SP1
III° 435x505x215 54M (18x3)	625133 (18M)	625REG	625SZ	625SI	600TC	625SC	625IO	625GI	625SP3
IV° 435x655x215 72M (18x4)	625133 (18 M)	625REG	625SZ	625SI	600TC	625SC	625IO	625GI	625SP3
V° 545x655x265 96M (24x4)	625135 (24 M)	625REG	625SZ	625SI	600TC	625SC	625IO	625GI	625SP5
VI° 620x810x320 140M (28x5)	625136 (28 M)	625REG	625SZ	625SI	600TC	625SC	625IO	625GI	625SP5

POLYESTER BOARDS - BLANK DOOR



ITEM	COLOUR	UM	DESCRIPTION	PACK-AGING
EC 625001	GC	PCS	270x305x170 (I°)	1
EC 625002	GC	PCS	325x430x185 (II°) 36 modules (3x12)	1
EC 625003	GC	PCS	435x505x215 (III°) 54 modules (3x18)	1
EC 625004	GC	PCS	435x655x215 (IV°) 72 modules (4x18)	1
EC 625005	GC	PCS	545x655x265 (V°) 96 modules (4x24)	1
EC 625006	GC	PCS	620x810x320 (VI°) 140 modules (5x28)	1

POLYESTER BOARDS - TRANSPARENT WINDOW



ITEM	COLOUR	UM	DESCRIPTION	PACK-AGING
EC 625011	GC	PCS	270x305x170 (I°)	1
EC 625012	GC	PCS	325x430x185 (II°) 36 modules (3x12)	1
EC 625013	GC	PCS	435x505x215 (III°) 54 modules (3x18)	1
EC 625014	GC	PCS	435x655x215 (IV°) 72 modules (4x18)	1
EC 625015	GC	PCS	545x655x265 (V°) 96 modules (4x24)	1
EC 625016	GC	PCS	620x810x320 (VI°) 140 modules (5x28)	1

BLANK SPARE DOOR



EC 625001R	GC	PCS	For board I°	1
EC 625002R	GC	PCS	For board II°	1
EC 625003R	GC	PCS	For board III°	1
EC 625004R	GC	PCS	For board IV°	1
EC 625005R	GC	PCS	For board V°	1
EC 625006R	GC	PCS	For board VI°	1

TRANSPARENT WINDOW SPARE DOOR



EC 625011R	GC	PCS	For board I°	1
EC 625012R	GC	PCS	For board II°	1
EC 625013R	GC	PCS	For board III°	1
EC 625014R	GC	PCS	For board IV°	1
EC 625015R	GC	PCS	For board V°	1
EC 625016R	GC	PCS	For board VI°	1

To get boards larger than 620x810 mm, you can put two or more boards with the same base or height together by using the joining kit EC625GI and the connecting devices series EC521XX.



EC 625GI



ITEM	COLOUR	UM	DESCRIPTION	PACK-AGING
------	--------	----	-------------	------------

POLYESTER HINGED COUNTERDOOR

	EC 625022	GC	PCS	for board 325x430	1
	EC 625023	GC	PCS	for board 435x505	1
	EC 625024	GC	PCS	for board 435x655	1
	EC 625025	GC	PCS	for board 545x655	1
	EC 625026	GC	PCS	for board 620x810	1

METAL BACK PLATE

	EC 625031	GC	PCS	Dim. 207x239 - I°	1
	EC 625032	GC	PCS	Dim. 264x364 - II°	1
	EC 625033	GC	PCS	Dim. 372x439 - III°	1
	EC 625034	GC	PCS	Dim. 372x589 - IV°	1
	EC 625035	GC	PCS	Dim. 482x589 - V°	1
	EC 625036	GC	PCS	Dim. 556x739 - VI°	1

INSULATING BACK PLATE

	EC 625041	GC	PCS	Dim. 207x239 - I°	1
	EC 625042	GC	PCS	Dim. 264x364 - II°	1
	EC 625043	GC	PCS	Dim. 372x439 - III°	1
	EC 625044	GC	PCS	Dim. 372x589 - IV°	1
	EC 625045	GC	PCS	Dim. 482x589 - V°	1
	EC 625046	GC	PCS	Dim. 556x739 - VI°	1

PAIR OF UP RIGHTS FOR RAIL DIN AND PANELS

	EC 625072	GC	1 pair	for board II°	1 pair
	EC 625073	GC	1 pair	for board III°	1 pair
	EC 625074	GC	1 pair	for boards IV - V°	1 pair
	EC 625076	GC	1 pair	for board VI°	1 pair

ITEM	COLOUR	UM	DESCRIPTION	PACK-AGING
------	--------	----	-------------	------------

COVER MODULE WITH WINDOW

	EC 625102	GC	PCS	12 modules - board II°	1
	EC 625103	GC	PCS	18 modules - board III°-IV°	1
	EC 625105	GC	PCS	24 modules - board V°	1
	EC 625106	GC	PCS	28 modules - board VI°	1

BLANK COVER MODULE

	EC 625112	GC	PCS	Height 125 - board II°	1
	EC 625113	GC	PCS	Height 150 - boards III°-IV°	1
	EC 625115	GC	PCS	Height 150 - board V°	1
	EC 625116	GC	PCS	Height 150 - board VI°	1

DOUBLE BLANK COVER MODULE

	EC 625122	GC	PCS	Height 250 - board II°	1
	EC 625123	GC	PCS	Height 300 - boards III°-IV°	1
	EC 625125	GC	PCS	Height 300 - board V°	1
	EC 625126	GC	PCS	Height 300 - board VI°	1

DIN RAIL WITH SUPPORTS

	EC 625132	GC	PCS	12 modules - board II°	1 kit
	EC 625133	GC	PCS	18 modules - boards III°-IV°	1 kit
	EC 625135	GC	PCS	24 modules - board V°	1 kit
	EC 625136	GC	PCS	28 modules - board VI°	1 kit

ITEM	COLOUR	UM	DESCRIPTION	PACK-AGING
------	--------	----	-------------	------------

DEEP ADJUSTMENT BACK PLATE KIT

EC 625REG	GC	PCS	II° and III° dim. need Nr° 2 kits, IV° and V° dim. need Nr° 3 kits, VI° dim. need Nr° 4 Kits	1 kit
------------------	----	-----	--	-------

ITEM	COLOUR	UM	DESCRIPTION	PACK-AGING
------	--------	----	-------------	------------

SET OF BRACKETS FOR FIXING

EC 625SZ		PCS	set of 4 steel brackets - galvanized	1 kit
EC 625SI		PCS	set of 4 steel brackets - stainless steel	1 kit

ITEM	COLOUR	UM	DESCRIPTION	PACK-AGING
------	--------	----	-------------	------------

MODULAR BLANK PLATE

EC 600TC	GC	PCS	blank plates (4,5 modules)	25
-----------------	----	-----	----------------------------	----

SAFETY LOCK

EC 625SC		PCS	safety lock with handle	1 kit
-----------------	--	-----	-------------------------	-------

Lock supplied with two unified keys.
The keys are unified and open all the locks.

SPARE BRASS INSERTS KIT

EC 625IO		PCS	insert kit (nr° 10)	1 kit
-----------------	--	-----	---------------------	-------

JOINT KIT

EC 625GI		PCS	joint kit for all boards	1 kit
-----------------	--	-----	--------------------------	-------

CONNECTING DEVICE

EC 52121	GC	PCS	joint - PG21 type	10/50
EC 52129	GC	PCS	joint - PG29 type	10/50
EC 52136	GC	PCS	joint - PG36 type	10/50

TRIANGULAR SPARE STANDARD LOCKS

EC 625SR	GC	PCS	Kit of 2 triangular spare standard lock	10 kit
-----------------	----	-----	---	--------

TRIANGULAR SPARE KEY

EC 625ST	GC	PCS	Triangular spare key	10
-----------------	----	-----	----------------------	----

POLE SUPPORT

EC 625SP1		PCS	Pole support 1° and 2° dimensions	1 kit
EC 625SP3		PCS	Pole support 3° and 4° dimensions	1 kit
EC 625SP5		PCS	Pole support 5° and 6° dimensions	1 kit



ENCLOSURE SYSTEMS



MAIN TECHNICAL FEATURES

Possibility to mount 45-78 mm high modules

New door closign

Modular blank plate and screw caps to gain double insulation

Reversible front

Suitable for cover sealing by proper screws (4-54 modules)

Possibility to install the safety lock on all models

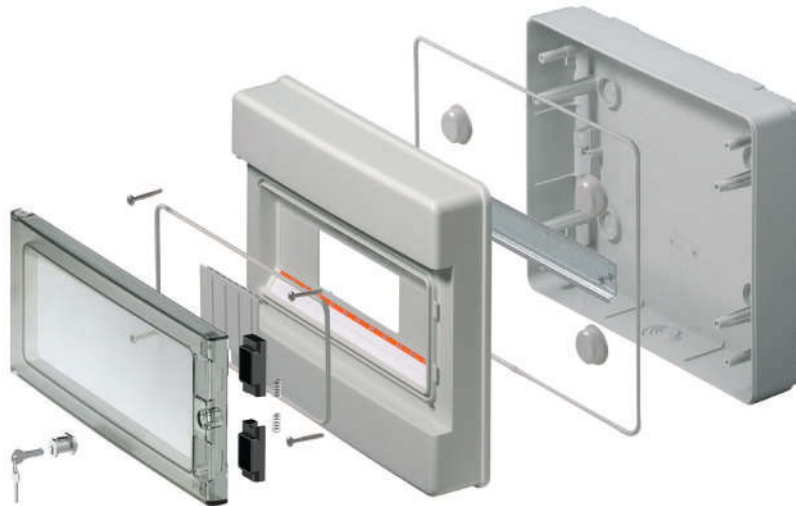

Internal pre-cuttings for conduit joints inside the enclosures

Kits of brass terminals specific for every model, easy to install

Self-adhesive circuit labels

Wall fixing bracket plastic to keep IP-protection and double insulation



Cable inlet through IP55 plastic stepped glands, IP44/IP66 conduit fittings and IP68 cable glands

The family of sealed modular enclosures series 620 with protection degree IP65 perfectly meets the protection and control needs of the modern distribution electrical systems in different environments, especially if wet or exposed to inclemency of the weather, to dust and pollution. In short they are suitable for any outdoor installation. The high-quality halogen free technopolymer assures a great

resistance to aging caused by the atmospheric agents and UV-rays. Thanks to the perfectly symmetric bottom and front the door can be reversed and opened at 180°. All watertight enclosures of 620 series are designed to be equipped with a coded safety lock, available as an accessory, to lock the doors to prevent incorrect operations. The cover fixing screws are made up of high-resistant stainless steel

and, once inserted in their seats, they can't fall off. The pre-cuttings for the cable inlet are placed inside the modular enclosure, so that the outer side is completely smooth, which permits to join the enclosures side by side and, moreover, to put the stepped glands, the conduit fittings and the cable glands, used to connect the enclosure, in any position.

WALL MOUNTING MODULAR ENCLOSURES WITH TRANSPARENT DOOR - IP40 - RAL 7035



ITEM	COLOUR	UM	DESCRIPTION	PACK-AGING
EC 60004	GC	PCS	4 modules	1/22
EC 60008	GC	PCS	8 modules	1/15
EC 60012	GC	PCS	12 modules	1/8
EC 60018	GC	PCS	18 modules	1
EC 60024	GC	PCS	24 modules (2x12)	1
EC 60036	GC	PCS	36 modules (2x18)	1
EC 60054	GC	PCS	54 modules (3x18)	1

WALL MOUNTING MODULAR ENCLOSURES WITH TRANSPARENT DOOR - IP40 - RAL 9001



ITEM	COLOUR	UM	DESCRIPTION	PACK-AGING
EC 60004B	B	PCS	4 modules	1/22
EC 60008B	B	PCS	8 modules	1/15
EC 60012B	B	PCS	12 modules	1/8
EC 60018B	B	PCS	18 modules	1
EC 60024B	B	PCS	24 modules (2x12)	1
EC 60036B	B	PCS	36 modules (2x18)	1
EC 60054B	B	PCS	54 modules (3x18)	1
EC 60072B	B	PCS	72 modules (4x18)	1

WALL MOUNTING MODULAR ENCLOSURES WITHOUT DOOR - IP40 - RAL 7035



ITEM	COLOUR	UM	DESCRIPTION	PACK-AGING
EC 61002	GC	PCS	2 modules	50
EC 61003	GC	PCS	4 modules	25



WALL MOUNTING MODULAR ENCLOSURES WITHOUT DOOR - IP40 - RAL 7035



ITEM	COLOUR	UM	DESCRIPTION	PACK-AGING
EC 61004	GC	PCS	4 modules	1/22
EC 61008	GC	PCS	8 modules	1/15
EC 61012	GC	PCS	12 modules	1/8
EC 61018	GC	PCS	18 modules	1
EC 61024	GC	PCS	24 modules (2x12)	1
EC 61036	GC	PCS	36 modules (2x18)	1
EC 61054	GC	PCS	54 modules (3x18)	1

ITEM	COLOUR	UM	DESCRIPTION	PACK-AGING
------	--------	----	-------------	------------

INSTALLATION KIT FOR WALL MOUNTING MODULAR ENCLOSURES



EC 6004EQ	PCS	for 4 modules	1/22
EC 6008EQ	PCS	for 8 modules	1/15
EC 6012EQ	PCS	for 12 modules	1/8
EC 6024EQ	PCS	for 24 modules	1/5
EC 6036EQ	PCS	for 36 modules	1/4
EC 6054EQ	PCS	for 54 modules	1

ITEM	COLOUR	UM	DESCRIPTION	PACK-AGING
------	--------	----	-------------	------------

PLASTIC BRACKET



EC 6005F	GC	PCS	plastic bracket to keep IP-protection and double insulation - for all enclosures series 600-610	50
-----------------	----	-----	---	----

ITEM	COLOUR	UM	DESCRIPTION	PACK-AGING
------	--------	----	-------------	------------

CONNECTING DEVICE FOR DISTRIBUTION ENCLOSURES



EC 52121	GC	PCS	joint - PG21 type	10/50
EC 52129	GC	PCS	joint - PG29 type	10/50
EC 52136	GC	PCS	joint - PG36 type	10/50

MAIN TECHNICAL FEATURES

Possibility to mount 45-78 mm high modules

The transparent door is removable, and the front is reversible

Kits of brass terminals specific for every model, easy to install

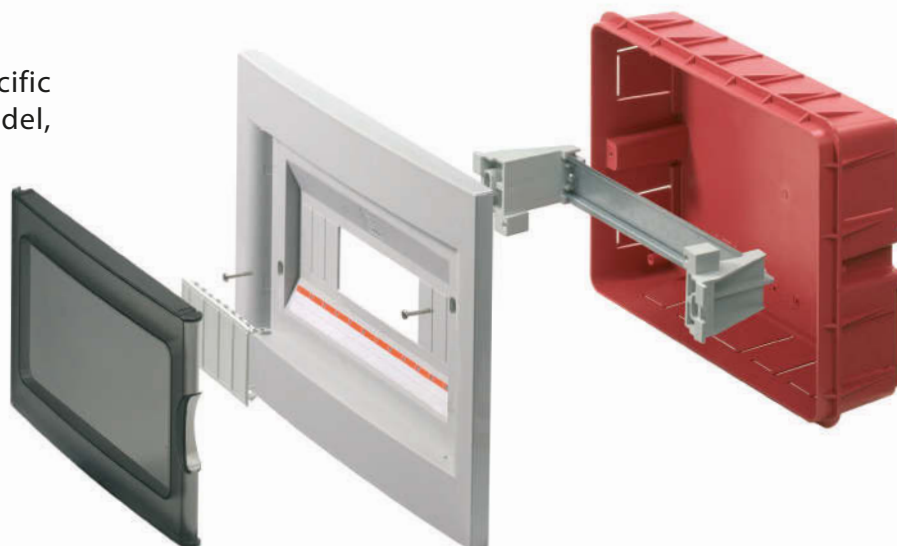

Strong enclosure structure with stiffening outer ring

Cover for unused modules included

Cable inlet by corrugated conduits up to 40 mm

The supports of the DIN-rails permit to compensate for the variable thickness of the plaster in order to align the devices at the correct depth

Self-adhesive circuit labels

The range of flush mounting modular enclosures is wide and complete: it comprises enclosures from 4 up to 72 modules available in different colours, such as grey, black, white with transparent smoky grey and white with solid door. They are suitable both for the industrial applications and for the domestic and public environments, in which the domotics plays a very important role nowadays.

The enclosures, made up of orange polystyrene, have a high mechanical strength, so that they don't get deformed during the installation; besides, they are characterized by pre-cuttings for the conduit inlet up to 40 mm.

Both the bottom and the front are perfectly symmetric, so that there is no top or bottom to pay attention to during the installation. The reversible front permits to

open the door at more than 180° either right or left.

The stainless steel DIN rail EN50022 can be horizontally adjusted to perfectly line up the equipments and devices.

The support rails are so designed to compensate for the variable thickness of the plaster in order to align the devices at the correct depth.

FLUSH MOUNTING MODULAR ENCLOSURES TRANSPARENT DOOR - IP40 - RAL 7035



ITEM	COLOUR	UM	DESCRIPTION	PACK-AGING
EC 63004	GC	PCS	4 modules	1/20
EC 63008	GC	PCS	8 modules	1/9
EC 63012	GC	PCS	12 modules	1/7
EC 63018	GC	PCS	18 modules	1
EC 63024	GC	PCS	24 modules (2x12)	1
EC 63036	GC	PCS	36 modules (2x18)	1
EC 63054	GC	PCS	54 modules (3x18)	1
EC 63072	GC	PCS	72 modules (4x18)	1

FLUSH MOUNTING MODULAR ENCLOSURES TRANSPARENT DOOR - IP40 - RAL 9001



ITEM	COLOUR	UM	DESCRIPTION	PACK-AGING
EC 63004B	B	PCS	4 modules	1/20
EC 63008B	B	PCS	8 modules	1/9
EC 63012B	B	PCS	12 modules	1/7
EC 63018B	B	PCS	18 modules	1
EC 63024B	B	PCS	24 modules (2x12)	1
EC 63036B	B	PCS	36 modules (2x18)	1
EC 63054B	B	PCS	54 modules (3x18)	1
EC 63072B	B	PCS	72 modules (4x18)	1

FLUSH MOUNTING MODULAR ENCLOSURES SOLID DOOR - IP40 - RAL 9001



ITEM	COLOUR	UM	DESCRIPTION	PACK-AGING
EC 63004C	B	PCS	4 modules	1/20
EC 63008C	B	PCS	8 modules	1/9
EC 63012C	B	PCS	12 modules	1/7
EC 63018C	B	PCS	18 modules	1
EC 63024C	B	PCS	24 modules (2x12)	1
EC 63036C	B	PCS	36 modules (2x18)	1
EC 63054C	B	PCS	54 modules (3x18)	1
EC 63072C	B	PCS	72 modules (4x18)	1

FLUSH MOUNTING MODULAR ENCLOSURES WITH SOLID DOOR - IP40 - RAL 9001



ITEM	COLOUR	UM	DESCRIPTION	PACK-AGING
EC 63004N	N	PCS	4 modules	1/20
EC 63008N	N	PCS	8 modules	1/9
EC 63012N	N	PCS	12 modules	1/7
EC 63018N	N	PCS	18 modules	1
EC 63024N	N	PCS	24 modules (2x12)	1
EC 63036N	N	PCS	36 modules (2x18)	1
EC 63054N	N	PCS	54 modules (3x18)	1
EC 63072N	N	PCS	72 modules (4x18)	1

DRY LINING MODULAR DISTRIBUTION ENCLOSURES TRANSPARENT DOOR - IP40 - RAL 9001



ITEM	COLOUR	UM	DESCRIPTION	PACK-AGING
EC 63508B	B	PCS	8 modules	1/9
EC 63512B	B	PCS	12 modules	1/7
EC 63518B	B	PCS	18 modules	1
EC 63524B	B	PCS	24 modules (2x12)	1
EC 63536B	B	PCS	36 modules (2x18)	1
EC 63554B	B	PCS	54 modules (3x18)	1
EC 63572B	B	PCS	72 modules (4x18)	1

WALL BOX FOR ELECTRICAL DEVICES "MYLIFE" SYSTEM OR SIMILAR - IP44



ITEM	COLOUR	UM	DESCRIPTION	PACK-AGING
EC L5610A1	GC	PCS	1 device	1/60
EC L5610A2	GC	PCS	2 devices	1/60
EC L5610A3	GC	PCS	3 devices	1/40
EC L5610A4	GC	PCS	4 devices	1/30
EC L5610A6	GC	PCS	6 devices	1/18

WALL BOX FOR ELECTRICAL DEVICES "MYLIFE" SYSTEM OR SIMILAR - IP55



ITEM	COLOUR	UM	DESCRIPTION	PACK-AGING
EC L5611A1	GC	PCS	1 device	1/50
EC L5611A2	GC	PCS	2 devices	1/50
EC L5611A3	GC	PCS	3 devices	1/35
EC L5611A4	GC	PCS	4 devices	1/25
EC L5611A6	GC	PCS	6 devices	1/15

On request all "MYLIFE" sockets or devices mounted.

ITEM	COLOUR	UM	DESCRIPTION	PACK-AGING	ITEM	COLOUR	UM	DESCRIPTION	PACK-AGING	ITEM	COLOUR	UM	DESCRIPTION	PACK-AGING					
INSTALLATION KIT FOR FLUSH MOUNTING MODULAR ENCLOSURES 					BLANK PLATE FOR 72 MODULES ENCLOSURE 					MODULAR BLANK PLATE - 4,5 MODULES 									
EC 6304EQ		PCS	for 4 modules	1/20	EC 67018	GC	PCS	blank plate 18 modules for 63072	1/10	EC 600TC	GC	PCS	4,5 modules - grey	25					
EC 6308EQ		PCS	for 8 modules	1/9						EC 600TCB	B	PCS	4,5 modules - white	25					
EC 6312EQ		PCS	for 12 modules	1/7						EC 600TCR	R	PCS	4,5 modules - red	25					
EC 6324EQ		PCS	for 24 modules	1/5						EC 600TCN	N	PCS	4,5 modules - black	25					
EC 6336EQ		PCS	for 36 modules	1/4	TERMINAL BLOCK PLASTIC SUPPORTS 					BRASS TERMINAL BLOCKS 					INSULATED BRASS TERMINAL BLOCK TO BE SET ON DIN EN 50022 RAIL 				
EC 6354EQ		PCS	for 54/72 modules	1	EC 680M1		PCS	4x16	10	EC 890050		PCS	1x35+ 6x16-blue	10/340					
					EC 680M2		PCS	2x16 + 6x10	10	EC 890051		PCS	1x35+1x25+ 10x16-blue	10/320					
					EC 680M3		PCS	2x16 + 10x10	10	EC 890052		PCS	1x35+2x25+ 12x16-blue	10/240					
					EC 680M4		PCS	1x25 + 4x10	10	EC 890053		PCS	1x35+ 6x16-green	10/340					
					EC 680M5		PCS	1x25 + 6x10	10	EC 890054		PCS	1x35+1x25+ 10x16-green	10/320					
					EC 680M6		PCS	2x25 + 8x10	10	EC 890055		PCS	1x35+2x25+ 12x16-green	10/240					
										EC 890056		PCS	1x35+ 6x16-black	10/340					
										EC 890057		PCS	1x35+1x25+ 10x16-black	10/320					
										EC 890058		PCS	1x35+2x25+ 12x16-black	10/240					

IP55 WATERPROOF ELECTRICAL DEVICES

ITEM	COLOUR	UM	DESCRIPTION	PACK-AGING
------	--------	----	-------------	------------

1 DEVICE TYPE

	ECL40001WH	GC	PCS	Nr. 1 - One way single pole switch 16AX 250V~	1/15
---	-------------------	----	-----	---	------

1 DEVICE TYPE

	ECL40091WH	GC	PCS	Nr. 1 - One way double pole switch 16AX 250V~	1/15
---	-------------------	----	-----	---	------

1 DEVICE TYPE

	ECL40121WH	GC	PCS	Nr. 1 - One way single pole switch 16AX 250V~ Nr. 1 - Neon Lamp 230V~ 0,5W	1/15
---	-------------------	----	-----	---	------

1 DEVICE TYPE

	ECL40611WH	GC	PCS	Nr. 1 - One way single pole switch with key 6A 250V~	1/15
---	-------------------	----	-----	--	------

ITEM	COLOUR	UM	DESCRIPTION	PACK-AGING
------	--------	----	-------------	------------

2 DEVICE TYPE

	ECL40452WH	GC	PCS	Nr. 2 - Italian double shuttered sockets 2P+T P11/17 10/16A 250V~	1/15
---	-------------------	----	-----	---	------

2 DEVICE TYPE

	ECL40471WH	GC	PCS	Nr. 1 - German shuttered socket 2P+T P30 16A 250V~	1/15
---	-------------------	----	-----	--	------

2 DEVICE TYPE

	ECL40411WH	GC	PCS	English shuttered sockets 2P+T 13A 250V~	1/15
---	-------------------	----	-----	--	------

2 DEVICE TYPE

	ECL40212WH	GC	PCS	Nr. 2 - Push button 16A 250V~	1/15
---	-------------------	----	-----	-------------------------------	------

ITEM	COLOUR	UM	DESCRIPTION	PACK-AGING
------	--------	----	-------------	------------

3 DEVICE TYPE

	ECL40413WH	GC	PCS	Nr. 1 - One way single pole switch 16AX 250V~ Nr. 1 + English shuttered socket 2P+T 13A 250V~	1/10
---	-------------------	----	-----	--	------

3 DEVICE TYPE

	ECL40443WH	GC	PCS	Nr. 1 - One way single pole switch 16AX 250V~ + Nr. 1 - French shuttered socket 2P+T 16A 250V~	1/10
---	-------------------	----	-----	---	------

3 DEVICE TYPE

	ECL40453WH	GC	PCS	Nr. 1 - One way single pole switch 16AX 250V~ + Nr. 2 - Italian double shuttered sockets 2P+T P11/17 10/16A 250V~	1/10
---	-------------------	----	-----	--	------

ITEM	COLOUR	UM	DESCRIPTION	PACK-AGING
------	--------	----	-------------	------------

1 DEVICE TYPE

	ECL402111WH	GC	PCS	Nr. 1 - Push button with bell symbol 16A 250V~	1/15
---	--------------------	----	-----	--	------

1 DEVICE TYPE

	ECL40181WH	GC	PCS	Nr. 1 - Push button 16A 250V~ Nr. 1 - Neon Lamp 230V~ 0,5W	1/15
---	-------------------	----	-----	---	------

1 DEVICE TYPE

	ECL40211WH	GC	PCS	Nr. 1 - Push button 16A 250V~	1/15
---	-------------------	----	-----	-------------------------------	------

ITEM	COLOUR	UM	DESCRIPTION	PACK-AGING
------	--------	----	-------------	------------

2 DEVICE TYPE

	ECL40501WH	GC	PCS	Nr. 1 - Italian/German triple shuttered socket 2P+T P17/30 10/16A 250V~	1/15
---	-------------------	----	-----	---	------

2 DEVICE TYPE

	ECL40441WH	GC	PCS	Nr. 1 - French shuttered socket 2P+T 16A 250V~	1/15
---	-------------------	----	-----	--	------

2 DEVICE TYPE

	ECL4050R1	GC	PCS	Nr. 1 - Italian/German triple shuttered red socket 2P+T P17/30 10/16A 250V~	1/15
---	------------------	----	-----	---	------

2 DEVICE TYPE

	ECL40002WH	GC	PCS	Nr. 2 - One way single pole switch 16AX 250V~	1/15
---	-------------------	----	-----	---	------

ITEM	COLOUR	UM	DESCRIPTION	PACK-AGING
------	--------	----	-------------	------------

3 DEVICE TYPE

	ECL40473WH	GC	PCS	Nr. 1 - One way single pole switch 16AX 250V~ + Nr. 1 - German shuttered socket 2P+T P30 16A 250V~	1/10
---	-------------------	----	-----	---	------

3 DEVICE TYPE

	ECL40503WH	GC	PCS	Nr. 1 - One way single pole switch 16AX 250V~ + Nr. 1 - Italian/German triple shuttered socket 2P+T P17/30 10/16A 250V~	1/10
---	-------------------	----	-----	--	------

JUNCTION BOXES



TECHNICAL SPECIFICATION

Particularly strong design to grant the right rigidity also on rough or irregular walls

Integrated hinges for an easy and quick installation

The back plates, the din rails and the brass terminal blocks can be mounted very easily thanks to the proper guides

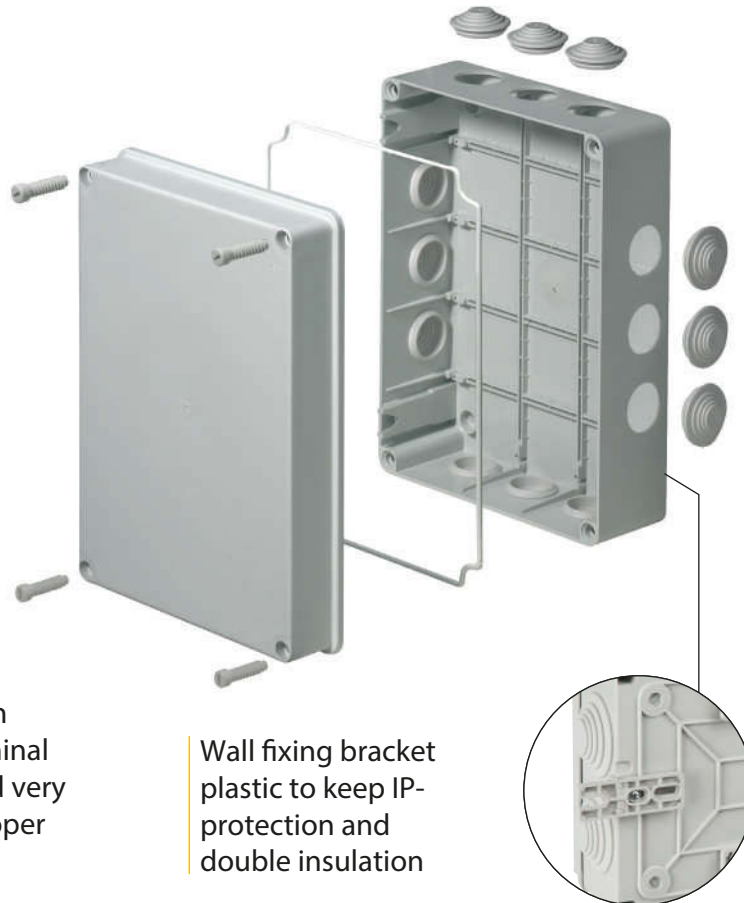

Wall fixing bracket plastic to keep IP-protection and double insulation

A draining hole can be easily made in the box wall

Soft stepped glands perfectly fitting to the box and easy to cut

Anticorrosive steel screws or quick-closing ¼ turn plastic screws

Lid with integrated gasket

The wall mounting junction boxes are manufactured either with thermoresistant halogen free material (GWT 650°C) or with self-extinguishing raw material (GWT 960°C). With 175 items, divided in different series, the range of the wall mounting boxes fulfils any distribution or derivation need the installer has: stepped glands or smooth-sides, solid or clear covers, low or high

covers, steel or plastic screws. The boxes made of self-extinguishing ABS with a high resistance to abnormal heat (960° C) is suitable for the heaviest applications and, in the red version, can be used in fire and security systems. The polycarbonate boxes offer the installers the ideal solution for their specific and particular applications. The boxes can be installed very

easily and quickly thanks to the accessories supplied with the box or available as fittings. The high mechanical strength protects the wiring devices and equipments in the outdoor installations, in industrial and domestic applications. The range also includes the boxes suitable for electrical devices like GW systems, Magic or similar ones.

POLYETHYLENE CABLE JUNCTION BOX - IP55



ITEM	COLOUR	UM	DESCRIPTION INTERNAL DIMENSIONS	PACK-AGING
EC 411C1	GC	PCS	71x33x30 - 6 inlets 8-14 mm + 4 inlets 7-9 mm	100
EC 411C2	GC	PCS	65x65x30 - 7 inlets 8-14 mm	50
EC 411C3	GC	PCS	75x75x34 - 12 inlets 8-14 mm	36
EC 411C4	GC	PCS	90x90x34 - 16 inlets 8-14 mm	46

JUNCTION BOX WITH STEPPED GLANDS - IP44



ITEM	COLOUR	UM	DESCRIPTION INTERNAL DIMENSIONS	PACK-AGING
EC 400C1	GC	PCS	Ø 65x35	5/120
EC 400C2	GC	PCS	Ø 80x40	5/150
EC 400C3	GC	PCS	80x80x40	5/160
EC 400C1A	GC	PCS	Ø 65x35 - GWT 960°	5/120
EC 400C2A	GC	PCS	Ø 80x40 - GWT 960°	5/150
EC 400C3A	GC	PCS	80x80x40 - GWT 960°	5/160

JUNCTION BOX WITH STEPPED GLANDS - IP55



ITEM	COLOUR	UM	DESCRIPTION INTERNAL DIMENSIONS	PACK-AGING
EC 400C4	GC	PCS	100x100x50	1/90
EC 400C4R	GC	PCS	120x80x50	1/90
EC 400C5	GC	PCS	150x110x70	1/45
EC 400C6	GC	PCS	190x140x70	1/25
EC 400C7	GC	PCS	240x190x90	1/14
EC 400C8	GC	PCS	300x220x120	1/6
EC 400C9	GC	PCS	380x300x120	1/4
EC 400C10	GC	PCS	460x380x120	1/4
EC 400C4A	GC	PCS	100x100x50 - GWT 960°	1/90
EC 400C4RA	GC	PCS	120x80x50 - GWT 960°	1/90
EC 400C5A	GC	PCS	150x110x70 - GWT 960°	1/45
EC 400C6A	GC	PCS	190x140x70 - GWT 960°	1/25
EC 400C7A	GC	PCS	240x190x90 - GWT 960°	1/14
EC 400C8A	GC	PCS	300x220x120 - GWT 960°	1/6
EC 400C9A	GC	PCS	380x300x120 - GWT 960°	1/4
EC 400C10A	GC	PCS	460x380x120 - GWT 960°	1/4

SMOOTH SIDED JUNCTION BOX - IP56



ITEM	COLOUR	UM	DESCRIPTION INTERNAL DIMENSIONS	PACK-AGING
EC 410C4	GC	PCS	100x100x50	1/100
EC 410C4R	GC	PCS	120x80x50	1/100
EC 410C5	GC	PCS	150x110x70	1/42
EC 410C6	GC	PCS	190x140x70	1/24
EC 410C7	GC	PCS	240x190x90	1/16
EC 410C8	GC	PCS	300x220x120	1/6
EC 410C9	GC	PCS	380x300x120	1/4
EC 410C10	GC	PCS	460x380x120	1/4
EC 410C4A	GC	PCS	100x100x50 - GWT 960°	1/100
EC 410C4RA	GC	PCS	120x80x50 - GWT 960°	1/100
EC 410C5A	GC	PCS	150x110x70 - GWT 960°	1/42
EC 410C6A	GC	PCS	190x140x70 - GWT 960°	1/24
EC 410C7A	GC	PCS	240x190x90 - GWT 960°	1/16
EC 410C8A	GC	PCS	300x220x120 - GWT 960°	1/6
EC 410C9A	GC	PCS	380x300x120 - GWT 960°	1/4
EC 410C10A	GC	PCS	460x380x120 - GWT 960°	1/4

SMOOTH SIDED JUNCTION BOX - TRANSPARENT LID - IP56



ITEM	COLOUR	UM	DESCRIPTION INTERNAL DIMENSIONS	PACK-AGING
EC 420C5	GC	PCS	150x110x70	1/42
EC 420C6	GC	PCS	190x140x70	1/24
EC 420C7	GC	PCS	240x190x90	1/16
EC 420C8	GC	PCS	300x220x120	1/6
EC 420C9	GC	PCS	380x300x120	1/4
EC 420C10	GC	PCS	460x380x120	1/4

SMOOTH SIDED JUNCTION BOX - HIGH LID - IP56



ITEM	COLOUR	UM	DESCRIPTION INTERNAL DIMENSIONS	PACK-AGING
EC 430C5	GC	PCS	150x110x140	1/18
EC 430C6	GC	PCS	190x140x140	1/16
EC 430C7	GC	PCS	240x190x160	1/8
EC 430C8	GC	PCS	300x220x180	1/4
EC 430C9	GC	PCS	380x300x180	1/3

SMOOTH SIDED JUNCTION BOX - HIGH TRANSPARENT LID - IP56



ITEM	COLOUR	UM	DESCRIPTION INTERNAL DIMENSIONS	PACK-AGING
EC 440C5	GC	PCS	150x110x140	1/18
EC 440C6	GC	PCS	190x140x140	1/16
EC 440C7	GC	PCS	240x190x160	1/8
EC 440C8	GC	PCS	300x220x180	1/4
EC 440C9	GC	PCS	380x300x180	1/3

SMOOTH SIDED BOX - IP44



ITEM	COLOUR	UM	DESCRIPTION INTERNAL DIMENSIONS	PACK-AGING
EC 410C3	GC	PCS	80x80x40	5/150

SMOOTH SIDED JUNCTION BOX - IP56 - 120°C



120°
polycarbonate

ITEM	COLOUR	UM	DESCRIPTION INTERNAL DIMENSIONS	PACK-AGING
EC 480C4	GC	PCS	100x100x50	1/100
EC 480C4R	GC	PCS	120x80x50	1/100
EC 480C5	GC	PCS	150x110x70	1/42
EC 480C6	GC	PCS	190x140x70	1/24
EC 480C7	GC	PCS	240x190x90	1/16
EC 480C8	GC	PCS	300x220x120	1/6
EC 480C9	GC	PCS	380x300x120	1/4
EC 480C10	GC	PCS	460x380x120	1/4

SMOOTH SIDED JUNCTION BOX - HIGH LID - IP56 - 120°C



120°
polycarbonate

ITEM	COLOUR	UM	DESCRIPTION INTERNAL DIMENSIONS	PACK-AGING
EC 490C5	GC	PCS	150x110x140	1/18
EC 490C6	GC	PCS	190x140x140	1/16
EC 490C7	GC	PCS	240x190x160	1/8
EC 490C8	GC	PCS	300x220x180	1/4
EC 490C9	GC	PCS	380x300x180	1/3

ITEM	COLOUR	UM	DESCRIPTION	PACK-AGING	ITEM	COLOUR	UM	DESCRIPTION	PACK-AGING	ITEM	COLOUR	UM	DESCRIPTION	PACK-AGING	
METAL BACK PLATE 					INSULATING PLASTIC BACK PLATE 					DIN RAILS EN 50022 FOR JUNCTION BOXES 					
EC 450P6		PCS	190x140	1/30	EC 451P6		PCS	190x140	1/30	EC 460D5		PCS	150x110	10	
EC 450P7		PCS	240x190	1/30	EC 451P7		PCS	240x190	1/30	EC 460D6		PCS	190x140	10	
EC 450P8		PCS	300x220	1/20	EC 451P8		PCS	300x220	1/20	EC 460D7		PCS	240x190	10	
EC 450P9		PCS	380x300	1/10	EC 451P9		PCS	380x300	1/10	EC 460D8		PCS	300x220	10	
EC 450P10		PCS	460x380	1/10	EC 451P10		PCS	460x380	1/10	EC 460D9		PCS	380x300	10	
PLASTIC STEPPED GLAND 					SCREW HEAD CAPS FOR DOUBLE INSULATION 					PLASTIC BRACKET 					
EC 47020	GC	PCS	concentric - hole Ø 23	100/800	EC TFLEX13	GC	PCS	caps for C1-C2-C3-C4	100/2000	EC 600SF	GC	PCS	plastic bracket to keep IP-protection and double insulation - for all boxes series 400/410/420/430/440/480/490 - dimensions C6-C7-C8-C9-C10	50	
EC 47025	GC	PCS	concentric - hole Ø 29	100/600	EC TFLEX18	GC	PCS	caps for C5-C6-C7-C8	100/2000						
EC 47032	GC	PCS	concentric - hole Ø 37	100/500	EC TFLEX25	GC	PCS	caps for C9-C10	100/1500						
EC 47040	GC	PCS	concentric - hole Ø 48	100/300											
EC 47025S	GC	PCS	direct inlet - hole Ø 29	100/600											
SPARE SCREWS 															
EC 400KV1		PCS	10 screws for C4-C5-C6	10											
EC 400KV2		PCS	10 screws for C7	10											
EC 400KV3		PCS	10 screws for C8-C9-C10	10											

new items in this page

1/4 TURN PLASTIC SCREWS

JUNCTION BOX WITH CABLE DIRECT INLET - IP55



ITEM	COLOUR	UM	DESCRIPTION INTERNAL DIMENSIONS	PACK- AGING
EC 401C4	GC	PCS	105x105x55	1/60
EC 401C5	GC	PCS	155x110x70	1/45

JUNCTION BOX WITH STEPPED GLANDS - IP55



ITEM	COLOUR	UM	DESCRIPTION INTERNAL DIMENSIONS	PACK- AGING
EC 405C4	GC	PCS	105x105x55	1/60
EC 405C5	GC	PCS	155x110x70	1/45
EC 405C4A	GC	PCS	105x105x55 - GWT 960°	1/60
EC 405C5A	GC	PCS	155x110x70 - GWT 960°	1/45

SMOOTH SIDED JUNCTION BOX - IP56



ITEM	COLOUR	UM	DESCRIPTION INTERNAL DIMENSIONS	PACK- AGING
EC 415C4	GC	PCS	105x105x55	1/80
EC 415C5	GC	PCS	155x110x70	1/42
EC 415C4A	GC	PCS	105x105x55 - GWT 960°	1/80
EC 415C5A	GC	PCS	155x110x70 - GWT 960°	1/42

RED JUNCTION BOX WITH STEPPED GLANDS - IP55 - V0 - 960°C



ITEM	COLOUR	UM	DESCRIPTION INTERNAL DIMENSIONS	PACK- AGING
EC 406C4A	R	PCS	105x105x55	1/60
EC 406C5A	R	PCS	155x110x70	1/45

RED SMOOTH SIDED JUNCTION BOX - IP56 - V0 - 960°C



ITEM	COLOUR	UM	DESCRIPTION INTERNAL DIMENSIONS	PACK- AGING
EC 416C4A	R	PCS	105x105x55	1/80
EC 416C5A	R	PCS	155x110x70	1/42

ALVEOLAR BOARD WITH REVERSIBLE DOOR

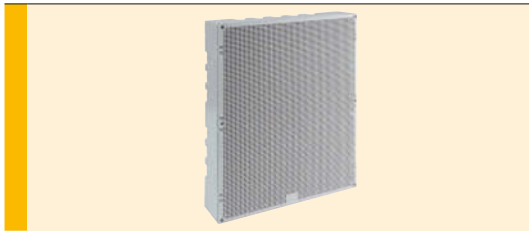

ITEM	COLOUR	UM	DESCRIPTION INTERNAL DIMENSIONS	PACK-AGING
EC 65001	GC	PCS	200x150x40	1/20
EC 65002	GC	PCS	200x150x60	1/40
EC 65003	GC	PCS	200x150x80	1/28
EC 65004	GC	PCS	300x200x40	1/30
EC 65005	GC	PCS	300x200x60	1/16
EC 65006	GC	PCS	300x200x80	1/12
EC 65007	GC	PCS	300x200x120	1/8
EC 65008	GC	PCS	400x300x60	1/8
EC 65009	GC	PCS	400x300x80	1/6
EC 65010	GC	PCS	400x300x120	1/4

ALUMINUM WALL MOUNTING JUNCTION BOX - IP66



ITEM	COLOUR	UM	DESCRIPTION INTERNAL DIMENSIONS	PACK-AGING
EC 485C1		PCS	90x90x53	1/32
EC 485C2		PCS	128x103x55	1/24
EC 485C3		PCS	154x129x58	1/16
EC 485C4		PCS	178x155x74	1/18
EC 485C5		PCS	239x202x85	1/8
EC 485C6		PCS	294x244x114	1/2
EC 485C7		PCS	392x298x144 (IP55)	1/2

WARNING LIGHT



ITEM	COLOUR	UM	DESCRIPTION INTERNAL DIMENSIONS	PACK-AGING
EC 320B		PCS	blue colour - E14	1/30
EC 320G		PCS	yellow colour - E14	1/30
EC 320R		PCS	red colour - E14	1/30
EC 320T		PCS	transparent colour - E14	1/30
EC 320V		PCS	green colour - E14	1/30

ITEM	COLOUR	UM	DESCRIPTION INTERNAL DIMENSIONS	PACK-AGING
------	--------	----	------------------------------------	------------

METAL BACK PLATE FOR ALUMINUM JUNCTION BOXES



EC 455P2		PCS	122x97	1/30
EC 455P3		PCS	147x123	1/30
EC 455P4		PCS	165x124	1/30
EC 455P5		PCS	206x172	1/20
EC 455P6		PCS	254x210	1/10
EC 455P7		PCS	349x260	1/10

DIN RAILS EN 50022 FOR ALUMINUM JUNCTION BOXES



EC 465D1		PCS	90x90	10
EC 465D2		PCS	128x103	10
EC 465D3		PCS	154x129	10
EC 465D4		PCS	178x155	10
EC 465D5		PCS	239x202	10
EC 465D6		PCS	294x244	10
EC 465D7		PCS	392x298	10

ITEM	COLOUR	UM	DESCRIPTION INTERNAL DIMENSIONS	PACK-AGING
------	--------	----	------------------------------------	------------

SELF-SUPPORTING PROTECTING COVER FOR ELECTRICAL DEVICES GW SYSTEM, MAGIC OR SIMILAR - IP55



EC 316B	B	PCS	white - 3 devices	1/40
EC 316G	GC	PCS	grey - 3 devices	1/40
EC 316N	N	PCS	anthracit - 3 devices	1/40

WALL BOX FOR ELECTRICAL DEVICES GW SYSTEM, MAGIC OR SIMILAR - IP40



EC 300A1	GC	PCS	1 device	1/60
EC 300A2	GC	PCS	2 devices	1/60
EC 300A3	GC	PCS	3 devices	1/40
EC 300A4	GC	PCS	4 devices	1/30
EC 300A4V	GC	PCS	4 vertical devices	1/25
EC 300A6	GC	PCS	6 devices	1/20
EC 300A6V	GC	PCS	6 vertical devices	1/18

WALL BOX FOR ELECTRICAL DEVICES GW SYSTEM, MAGIC OR SIMILAR - IP55



EC 310A1	GC	PCS	1 device	1/50
EC 310A2	GC	PCS	2 devices	1/50
EC 310A3	GC	PCS	3 devices	1/35
EC 310A4	GC	PCS	4 devices	1/25
EC 310A4V	GC	PCS	4 vertical devices	1/20
EC 310A6V	GC	PCS	6 vertical devices	1/15



FLUSH MOUNTING JUNCTION BOX WITH COVER - IP40



ITEM	COLOUR	UM	DESCRIPTION INTERNAL DIMENSIONS	PACK-AGING
EC 350C1	B	PCS	92x92x45	1/240
EC 350C2	B	PCS	120x100x50	1/150
EC 350C3	B	PCS	120x100x70	1/100
EC 350C4	B	PCS	152x100x70	1/80
EC 350C5	B	PCS	160x130x70	1/60
EC 350C6	B	PCS	196x152x70	1/40
EC 350C7	B	PCS	294x152x70	1/28
EC 350C8	B	PCS	392x152x70	1/20
EC 350C9	B	PCS	480x160x70	1/18
EC 350C10	B	PCS	520x200x90	1/8
EC 350C11	B	PCS	520x295x90 (5 separators included)	1/6

FLUSH MOUNTING JUNCTION BOX WITH COVER AND PROTECTION LID - IP40



ITEM	COLOUR	UM	DESCRIPTION INTERNAL DIMENSIONS	PACK-AGING
EC 350C1P	B	PCS	92x92x45	1/120
EC 350C2P	B	PCS	120x100x50	1/90
EC 350C3P	B	PCS	120x100x70	1/70
EC 350C4P	B	PCS	152x100x70	1/80
EC 350C5P	B	PCS	160x130x70	1/60
EC 350C6P	B	PCS	196x152x70	1/40
EC 350C7P	B	PCS	294x152x70	1/28
EC 350C8P	B	PCS	392x152x70	1/20
EC 350C9P	B	PCS	480x160x70	1/18

SPARE COVERS FOR FLUSH MOUNTING BOX SERIES 350

ITEM	COLOUR	UM	DIMENSIONS	PACK-AGING
EC 351C1	B	PCS	92x92	1/200
EC 351C3	B	PCS	120x100	1/150
EC 351C4	B	PCS	152x100	1/120
EC 351C5	B	PCS	160x130	1/100
EC 351C6	B	PCS	196x152	1/50
EC 351C7	B	PCS	294x152	1/50
EC 351C8	B	PCS	392x152	1/50
EC 351C9	B	PCS	480x160	1/30
EC 351C10	B	PCS	520x200	1/20
EC 351C11	B	PCS	520x295	1/10

DIN RAIL FOR C10-C11

ITEM	COLOUR	UM	DIMENSIONS	PACK-AGING
EC 460C10		PCS	DIN rail for C10-C11 (8 modules)	10



ITEM	COLOUR	UM	DESCRIPTION	PACK-AGING
INTERNAL SEPARATOR				
EC 3500S		PCS	internal separator from C4 up to C9	10/100
EC 3510S		PCS	internal separator for C10-C11	10

ITEM	COLOUR	UM	DESCRIPTION	PACK-AGING
DIN RAILS EN 50022				
EC 460		PCS	35x7,5x1 - 2 mt	20
EC 46015		PCS	35x15x1,5 - 2 mt	10
EC 460F		PCS	35x7,5x1 - 2 mt perforated	20

ITEM	COLOUR	UM	DESCRIPTION	PACK-AGING
INSULATED BRASS TERMINAL BLOCK TO BE SET ON DIN EN 50022 RAIL				
EC 890050		PCS	1x35+6x16-blue	10/340
EC 890051		PCS	1x35+1x25+10x16-blue	10/320
EC 890052		PCS	1x35+2x25+12x16-blue	10/240
EC 890053		PCS	1x35+6x16-green	10/340
EC 890054		PCS	1x35+1x25+10x16-green	10/320
EC 890055		PCS	1x35+2x25+12x16-green	10/240
EC 890056		PCS	1x35+6x16-black	10/340
EC 890057		PCS	1x35+1x25+10x16-black	10/320
EC 890058		PCS	1x35+2x25+12x16-black	10/240

60x60 STANDARD MODULAR BOX FOR DEVICE



ITEM	COLOUR	UM	DESCRIPTION	PACK-AGING
EC 37301	AR	PCS	2 devices	300



MODULAR BOX FOR DEVICE - HIGH INTERNAL VOLUME



ITEM	COLOUR	UM	DESCRIPTION	PACK-AGING
EC 37100	G	PCS	3 devices	10/400
EC 37104	G	PCS	4 devices	10/240
EC 37106	G	PCS	6 devices	10/150
EC 37110	G	PCS	3 devices protection lid	10/400
EC 37111	G	PCS	plastic spacer	20/200

FLUSH MOUNTING ROUND BOXES



ITEM	COLOUR	UM	DESCRIPTION	PACK-AGING
EC 37065	AR	PCS	box Ø 60x40	10/600
EC 37085	AR	PCS	box Ø 80x40	10/400
EC 37160	B	PCS	screwless cover Ø 60	50/2000
EC 37165	B	PCS	cover with brackets Ø 60	50/800
EC 37180	B	PCS	screwless cover Ø 80	50/1200
EC 37185	B	PCS	cover with brackets Ø 80	50/600

DRY LINING INSTALLATION BOX - MODULAR DEVICES



ITEM	COLOUR	UM	DESCRIPTION	PACK-AGING
EC 34003	BL	PCS	3 devices	10/300
EC 34004	BL	PCS	4 devices	10/230
EC 34006	BL	PCS	6 devices	10/160
EC 34040	BL	PCS	Ø 68x40 - 2 devices	10/550

DRY LINING INSTALLATION JUNCTION BOXES



ITEM	COLOUR	UM	DESCRIPTION	PACK-AGING
EC 34045	BL	PCS	Ø 80x45	10/350
EC 37180	B	PCS	screwless cover Ø 80	50/1200
EC 37185	B	PCS	cover with brackets Ø 80	50/600

DRY LINING INSTALLATION JUNCTION BOXES



ITEM	COLOUR	UM	DESCRIPTION	PACK-AGING
EC 340105	B	PCS	120x100x50 - internal dimensions	1/150
EC 340106	B	PCS	200x150x75 - internal dimensions	1/40
EC 340107	B	PCS	300x150x75 - internal dimensions	1/28

CONDUITS SYSTEMS



1

RIGID, PLIABLE AND FLEXIBLE SPIRAL CONDUITS



2

ACCESSORIES FOR CONDUIT SYSTEMS



3

IP67 ACCESSORIES FOR CONDUIT SYSTEMS



4

CABLE GLANDS, CABLE TIES, TERMINAL BLOCKS

MAIN TECHNICAL FEATURES



The conduit-fitting systems, complying with the requirements of the Reference Standards EN 61386-1 and EN 61386-21, include plain or sleeved rigid conduits made of self-extinguishing technopolymer on rigid PVC base or halogen free raw materials according to the Standard EN50267-2-1 and EN 50267-1-2.

The halogen free conduits are strongly recommended for crowded places like airports, schools, theatres, tunnels, ecc, because they are characterized by a

low very emission or complete lack of toxic gases and of light smoke which doesn't prevent from locating the emergency exits und darkening the light sources.

The pliable conduits are available in two different versions: one manufactured with self-extinguishing (V0 according to the Standard UL94) technopolymer on PVC base and the other manufactured with self-extinguishing self-recovering halogen free polypropylene.

Great attention is given to the conduit packaging. Both the bundles

of rigid conduits and the coils of pliable conduits are wrapped in stretch film. The pallets are covered by white film, granting a very good protection against UV-rays and atmospheric agents. The pallets of pliable conduits also have a plastic hook on the top.

The range is completed by the spiral flexible conduits suitable for industrial as well as domestic uses thanks to their flexibility, resistance to compression, chemical agents, particularly oils and greases.

RIGID CONDUITS CLASS. 3321 IN 3 MT BARS

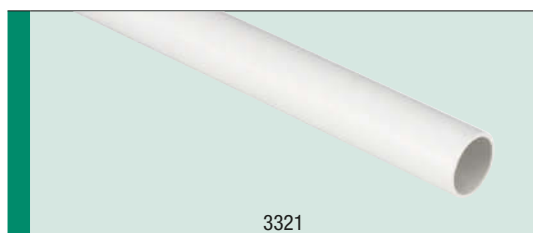

ITEM	COLOUR	UM	DESCRIPTION	PACK-AGING
EC TG1516	GC	MT	rigid conduit Ø 16	102/3162
EC TG1520	GC	MT	rigid conduit Ø 20	102/2040
EC TG1525	GC	MT	rigid conduit Ø 25	60/1440
EC TG1532	GC	MT	rigid conduit Ø 32	30/840
EC TG1540	GC	MT	rigid conduit Ø 40	30/540
EC TG1550	GC	MT	rigid conduit Ø 50	15/360
EC TG1563	GC	MT	rigid conduit Ø 63	180

RIGID CONDUITS CLASS. 2221 IN 3 MT BARS

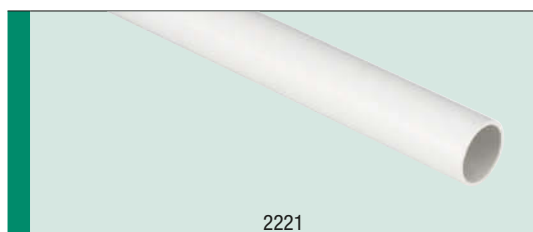

ITEM	COLOUR	UM	DESCRIPTION	PACK-AGING
EC TG1216	GC	MT	rigid conduit Ø 16	102/3162
EC TG1220	GC	MT	rigid conduit Ø 20	102/2040
EC TG1225	GC	MT	rigid conduit Ø 25	60/1440
EC TG1232	GC	MT	rigid conduit Ø 32	30/840
EC TG1240	GC	MT	rigid conduit Ø 40	30/540
EC TG1250	GC	MT	rigid conduit Ø 50	15/360

HALOGEN FREE RIGID CONDUITS CLASS. 2243 IN 3 MT BARS - WITH SLEEVE

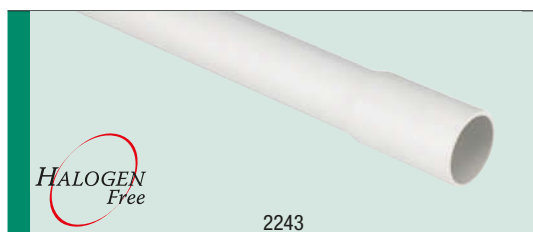

ITEM	COLOUR	UM	DESCRIPTION	PACK-AGING
EC TG2016B	GC	MT	rigid conduit Ø 16	102/3162
EC TG2020B	GC	MT	rigid conduit Ø 20	102/2040
EC TG2025B	GC	MT	rigid conduit Ø 25	60/1440
EC TG2032B	GC	MT	rigid conduit Ø 32	30/840
EC TG2040B	GC	MT	rigid conduit Ø 40	30/540
EC TG2050B	GC	MT	rigid conduit Ø 50	15/360

RIGID CONDUITS CLASS. 3321 IN 3 MT BARS WITH SLEEVE



ITEM	COLOUR	UM	DESCRIPTION	PACK-AGING
ECTG1516B	GC	MT	rigid conduit Ø 16	75/4500
ECTG1520B	GC	MT	rigid conduit Ø 20	51/3060
ECTG1525B	GC	MT	rigid conduit Ø 25	51/1836
ECTG1532B	GC	MT	rigid conduit Ø 32	30/1080
ECTG1540B	GC	MT	rigid conduit Ø 40	21/630
ECTG1550B	GC	MT	rigid conduit Ø 50	15/450

HALOGEN FREE RIGID CONDUITS CLASS. 3342 IN 3 MT BARS



ITEM	COLOUR	UM	DESCRIPTION	PACK-AGING
EC TG2116	GC	MT	rigid conduit Ø 16	102/3162
EC TG2120	GC	MT	rigid conduit Ø 20	102/2040
EC TG2125	GC	MT	rigid conduit Ø 25	60/1440
EC TG2132	GC	MT	rigid conduit Ø 32	30/840
EC TG2140	GC	MT	rigid conduit Ø 40	30/540
EC TG2150	GC	MT	rigid conduit Ø 50	15/360

RIGID CONDUITS CLASS. 2221 IN 3 MT BARS WITH SLEEVE



ITEM	COLOUR	UM	DESCRIPTION	PACK-AGING
ECTG1216B	GC	MT	rigid conduit Ø 16	102/3162
ECTG1220B	GC	MT	rigid conduit Ø 20	102/2040
ECTG1225B	GC	MT	rigid conduit Ø 25	60/1440
ECTG1232B	GC	MT	rigid conduit Ø 32	30/840
ECTG1240B	GC	MT	rigid conduit Ø 40	30/540
ECTG1250B	GC	MT	rigid conduit Ø 50	15/360

ITEM	COLOUR	UM	DESCRIPTION	PACK-AGING
------	--------	----	-------------	------------

STEEL SPRING FOR COLD-BENDING OF THE RIGID CONDUITS



EC AC16	PCS		for rigid conduit Ø 16	1
EC AC20	PCS		for rigid conduit Ø 20	1
EC AC25	PCS		for rigid conduit Ø 25	1
EC AC32	PCS		for rigid conduit Ø 32	1

ON REQUEST IN 2 MT BARS

PLIABLE CORRUGATED PVC CONDUITS CLASS. 3321

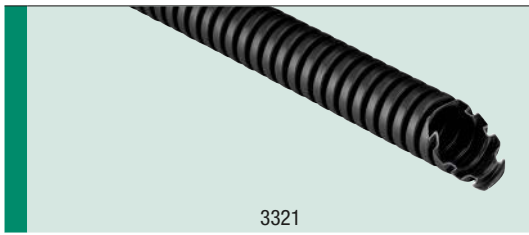

3321

Conduits available with draw tape on request.
Please add the letter "T" to the item code.

ITEM	COLOUR	UM	DESCRIPTION	PACK-AGING
EC TC1516	N	MT	pliable conduit Ø 16	100/6000
EC TC151650	N	MT	pliable conduit Ø 16	50/4800
EC TC1520	N	MT	pliable conduit Ø 20	100/5200
EC TC152050	N	MT	pliable conduit Ø 20	50/3300
EC TC1525	N	MT	pliable conduit Ø 25	50/3000
EC TC1532	N	MT	pliable conduit Ø 32	25/1600
EC TC1540	N	MT	pliable conduit Ø 40	25/1000
EC TC1550	N	MT	pliable conduit Ø 50	25/800

PLIABLE CORRUGATED PVC CONDUITS CLASS. 2221

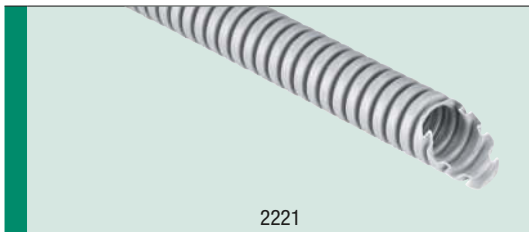

2221

ITEM	COLOUR	UM	DESCRIPTION	PACK-AGING
EC TC1216	GC	MT	pliable conduit Ø 16	100/6000
EC TC121650	GC	MT	pliable conduit Ø 16	50/4800
EC TC1220	GC	MT	pliable conduit Ø 20	100/4800
EC TC122050	GC	MT	pliable conduit Ø 20	50/3300
EC TC1225	GC	MT	pliable conduit Ø 25	50/2800
EC TC1225100	GC	MT	pliable conduit Ø 25	100/3600
EC TC1232	GC	MT	pliable conduit Ø 32	25/1600
EC TC123250	GC	MT	pliable conduit Ø 32	50/1800
EC TC1240	GC	MT	pliable conduit Ø 40	25/1000
EC TC1250	GC	MT	pliable conduit Ø 50	25/800

PLIABLE CORRUGATED PVC CONDUITS CLASS. 3341

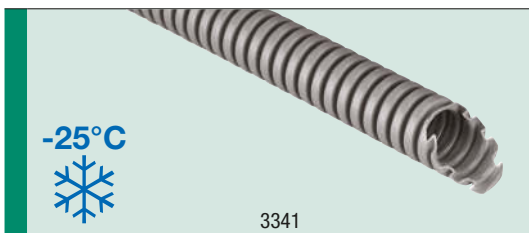

3341

ITEM	COLOUR	UM	DESCRIPTION	PACK-AGING
EC TC1816	G	MT	pliable conduit Ø 16	100/6000
EC TC181650	G	MT	pliable conduit Ø 16	50/4800
EC TC1820	G	MT	pliable conduit Ø 20	100/4800
EC TC182050	G	MT	pliable conduit Ø 20	50/3300
EC TC1825	G	MT	pliable conduit Ø 25	50/2800
EC TC1825100	G	MT	pliable conduit Ø 25	100/3600
EC TC1832	G	MT	pliable conduit Ø 32	25/1600
EC TC183250	G	MT	pliable conduit Ø 32	50/1800
EC TC1840	G	MT	pliable conduit Ø 40	25/1000
EC TC1850	G	MT	pliable conduit Ø 50	25/800

ITEM	COLOUR	UM	DESCRIPTION	PACK-AGING
------	--------	----	-------------	------------

PLIABLE CORRUGATED PVC CONDUITS CLASS. 3321 - 25 MT COILS



ECTC151625	N	PCS	pliable conduit Ø 16	198
ECTC152025	N	PCS	pliable conduit Ø 20	132
ECTC152525	N	PCS	pliable conduit Ø 25	99

PLIABLE CORRUGATED PVC CONDUITS CLASS. 3321 - 10 MT COILS



ECTC151610	N	PCS	pliable conduit Ø 16	288
ECTC152010	N	PCS	pliable conduit Ø 20	216
ECTC152510	N	PCS	pliable conduit Ø 25	165

PLIABLE CORRUGATED PVC CONDUITS CLASS. 2221 - 25 MT COILS



ECTC121625	GC	PCS	pliable conduit Ø 16	165
ECTC122025	GC	PCS	pliable conduit Ø 20	121
ECTC122525	GC	PCS	pliable conduit Ø 25	90

PLIABLE CORRUGATED PVC CONDUITS CLASS. 3341 (-25°C) - 25 MT COILS



ECTC181625	G	PCS	pliable conduit Ø 16	165
ECTC182025	G	PCS	pliable conduit Ø 20	121
ECTC182525	G	PCS	pliable conduit Ø 25	90

ITEM	COLOUR	UM	DESCRIPTION	PACK-AGING
------	--------	----	-------------	------------

PLIABLE CORRUGATED PVC CONDUITS CLASS. 3321 - COLOURED



EC TC1516		MT	pliable conduit Ø 16	100/6000
EC TC1520		MT	pliable conduit Ø 20	100/5200
EC TC1525		MT	pliable conduit Ø 25	50/3000
EC TC1532		MT	pliable conduit Ø 32	25/1600

• Please add the colour code to the item code: **VE**=Green, **B**=White, **BL**=Blue, **M**=Brown, **L**=Violet.

PLIABLE CORRUGATED PVC CONDUITS CLASS. 2221 - 10 MT COILS



ECTC121610	GC	PCS	pliable conduit Ø 16	288
ECTC122010	GC	PCS	pliable conduit Ø 20	216
ECTC122510	GC	PCS	pliable conduit Ø 25	154

PLIABLE CORRUGATED PVC CONDUITS CLASS. 3341 (-25°C) - 10 MT COILS



ECTC181610	G	PCS	pliable conduit Ø 16	288
ECTC182010	G	PCS	pliable conduit Ø 20	216
ECTC182510	G	PCS	pliable conduit Ø 25	154

PLIABLE CORRUGATED SELF-EXTINGUISHING-LUBRICATED CONDUITS CLASS. 3422 ICTA

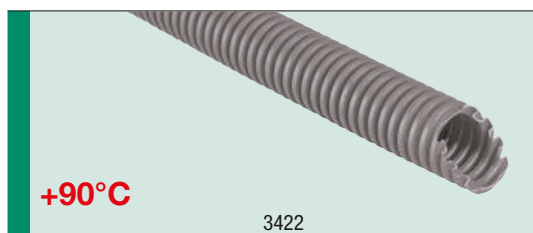

ITEM	COLOUR	UM	DESCRIPTION	PACK-AGING
EC ICTA16	G	MT	pliable conduit Ø 16	100/7000
EC ICTA20	G	MT	pliable conduit Ø 20	100/5000
EC ICTA25	G	MT	pliable conduit Ø 25	100/3600
EC ICTA32	G	MT	pliable conduit Ø 32	50/1800
EC ICTA40	G	MT	pliable conduit Ø 40	25/1000
EC ICTA50	G	MT	pliable conduit Ø 50	25/800

PLIABLE CORRUGATED SELF-EXTINGUISHING-LUBRICATED CONDUITS CLASS. 3422 ICTA WITH DRAW TAPE

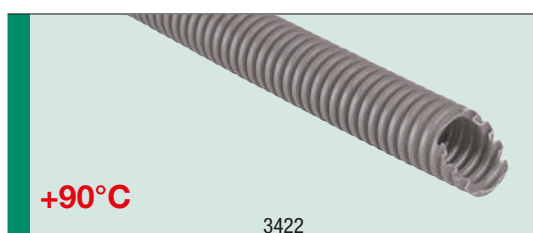

ITEM	COLOUR	UM	DESCRIPTION	PACK-AGING
EC ICTA16T	G	MT	pliable conduit Ø 16	100/7000
EC ICTA20T	G	MT	pliable conduit Ø 20	100/5000
EC ICTA25T	G	MT	pliable conduit Ø 25	100/3600
EC ICTA32T	G	MT	pliable conduit Ø 32	50/1800
EC ICTA40T	G	MT	pliable conduit Ø 40	25/1000
EC ICTA50T	G	MT	pliable conduit Ø 50	25/800

PLIABLE CORRUGATED SELF-EXTINGUISHING-LUBRICATED CONDUITS CLASS. 3422 ICTA LSZH

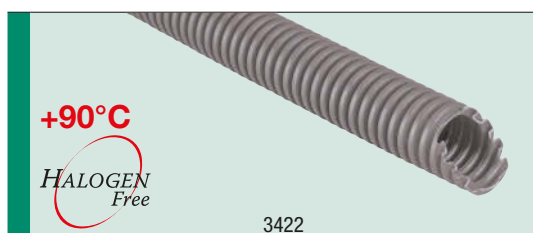

ITEM	COLOUR	UM	DESCRIPTION	PACK-AGING
EC ICTA16HF	G	MT	pliable conduit Ø 16	100/7000
EC ICTA20HF	G	MT	pliable conduit Ø 20	100/5000
EC ICTA25HF	G	MT	pliable conduit Ø 25	100/3600
EC ICTA32HF	G	MT	pliable conduit Ø 32	50/1800
EC ICTA40HF	G	MT	pliable conduit Ø 40	25/1000
EC ICTA50HF	G	MT	pliable conduit Ø 50	25/800

PLIABLE CORRUGATED SELF-EXTINGUISHING-LUBRICATED CONDUITS CLASS. 3422 ICTA LSZH WITH DRAW TAPE

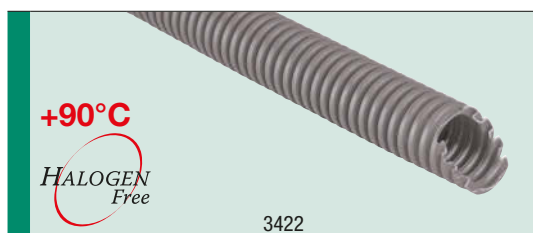

ITEM	COLOUR	UM	DESCRIPTION	PACK-AGING
EC ICTA16HFT	G	MT	pliable conduit Ø 16	100/7000
EC ICTA20HFT	G	MT	pliable conduit Ø 20	100/5000
EC ICTA25HFT	G	MT	pliable conduit Ø 25	100/3600
EC ICTA32HFT	G	MT	pliable conduit Ø 32	50/1800
EC ICTA40HFT	G	MT	pliable conduit Ø 40	25/1000
EC ICTA50HFT	G	MT	pliable conduit Ø 50	25/800

PLIABLE CORRUGATED SELF-EXTINGUISHING-LUBRICATED CONDUITS CLASS. 3422 ICTA LSZH - PREWIRED

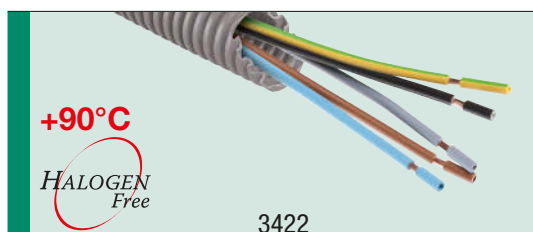

ITEM	COLOUR	UM	DESCRIPTION	PACK-AGING
EC ICTA163G15U	G	MT	H07V-U 3G1,5 - Ø 16	100/2800
EC ICTA163G25U	G	MT	H07V-U 3G2,5 - Ø 16	100/2800
EC ICTA164G15U	G	MT	H07V-U 4G1,5 - Ø 16	100/2800
EC ICTA165G15U	G	MT	H07V-U 5G1,5 - Ø 16	100/2800
EC ICTA165G25U	G	MT	H07V-U 5G2,5 - Ø 16	100/2800
EC ICTA205G25U	G	MT	H07V-U 5G2,5 - Ø 20	100/2400
EC ICTA163G15R	G	MT	H07V-R 3G1,5 - Ø 16	100/2800
EC ICTA164G15R	G	MT	H07V-R 4G1,5 - Ø 16	100/2800
EC ICTA165G15R	G	MT	H07V-R 5G1,5 - Ø 16	100/2800
EC ICTA163G25R	G	MT	H07V-R 3G2,5 - Ø 16	100/2800
EC ICTA205G25R	G	MT	H07V-R 5G2,5 - Ø 20	100/2400

1000N PLIABLE CORRUGATED SELF-EXTINGUISHING-LUBRICATED CONDUITS CLASS. 3422 BLUE

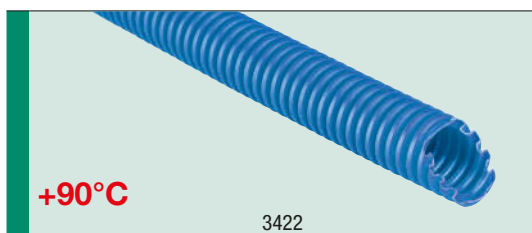

ITEM	COLOUR	UM	DESCRIPTION	PACK-AGING
EC ICTA16K	BL	MT	pliable conduit Ø 16	70/7000
EC ICTA20K	BL	MT	pliable conduit Ø 20	50/5000
EC ICTA25K	BL	MT	pliable conduit Ø 25	36/3600
EC ICTA32K	BL	MT	pliable conduit Ø 32	36/1800
EC ICTA40K	BL	MT	pliable conduit Ø 40	40/1000
EC ICTA50K	BL	MT	pliable conduit Ø 50	32/800

PLIABLE CORRUGATED SELF-RECOVERING-LUBRICATED CONDUITS CLASS. 2232 TP

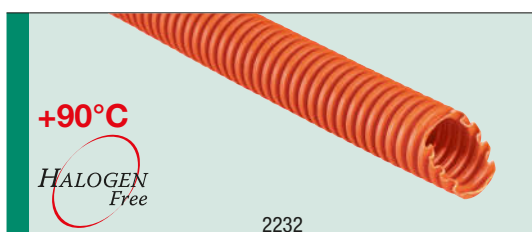

ITEM	COLOUR	UM	DESCRIPTION	PACK-AGING
EC TP1216	AR	MT	pliable conduit Ø 16	100/7000
EC TP1220	AR	MT	pliable conduit Ø 20	100/5000
EC TP1225	AR	MT	pliable conduit Ø 25	50/3000
EC TP1232	AR	MT	pliable conduit Ø 32	25/1600
EC TP1240	AR	MT	pliable conduit Ø 40	25/1000
EC TP1250	AR	MT	pliable conduit Ø 50	25/800

PLIABLE CORRUGATED SELF-RECOVERING-LUBRICATED CONDUITS CLASS. 3422 TP

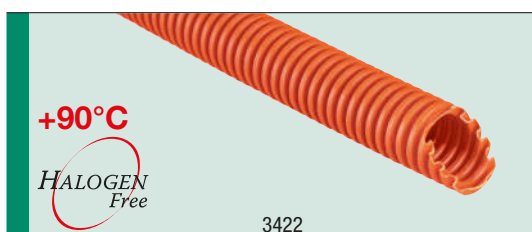

ITEM	COLOUR	UM	DESCRIPTION	PACK-AGING
EC TP1516	AR	MT	pliable conduit Ø 16	100/7000
EC TP1520	AR	MT	pliable conduit Ø 20	100/5000
EC TP1525	AR	MT	pliable conduit Ø 25	50/3000
EC TP1532	AR	MT	pliable conduit Ø 32	25/1600
EC TP1540	AR	MT	pliable conduit Ø 40	25/1000
EC TP1550	AR	MT	pliable conduit Ø 50	25/800

PLIABLE CORRUGATED SELF-RECOVERING-LUBRICATED CONDUITS CLASS. 2332 TP - LSZH

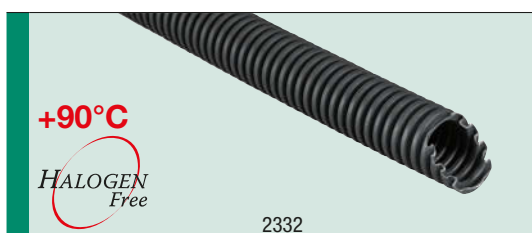

ITEM	COLOUR	UM	DESCRIPTION	PACK-AGING
EC TP2016	N	MT	pliable conduit Ø 16	100/7000
EC TP2020	N	MT	pliable conduit Ø 20	100/5000
EC TP2025	N	MT	pliable conduit Ø 25	50/3000
EC TP2032	N	MT	pliable conduit Ø 32	25/1600
EC TP2040	N	MT	pliable conduit Ø 40	25/1000
EC TP2050	N	MT	pliable conduit Ø 50	25/800



CORRUGATED / RIGID / INSULATING CONDUITS SPECIFIC FOR SOLAR / PHOTOVOLTAIC / WIND PLANTS

PLIABLE CORRUGATED INSULATING CONDUITS - UV RESISTANT - CLASS. 4442 - 1250N

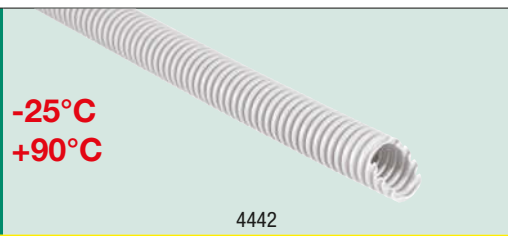
 <p>-25°C +90°C</p> <p>4442</p>	ITEM	COLOUR	UM	DESCRIPTION	PACK-AGING
	EC TP1820	GC	MT	pliable conduit Ø 20	100/5000
	EC TP1825	GC	MT	pliable conduit Ø 25	50/3000

RIGID INSULATING CONDUITS IN 3 MT BARS - UV RESISTANT - CLASS. 4341 - 1250N

 <p>-25°C +90°C</p> <p>4341</p>	ITEM	COLOUR	UM	DESCRIPTION	PACK-AGING
	EC TG1920	GC	MT	rigid conduit Ø 20	102/2040
	EC TG1925	GC	MT	rigid conduit Ø 25	60/1440

PREWIRED PLIABLE CORRUGATED INSULATING CONDUITS - UV RESISTANT - CLASS. 4442 - 1250N

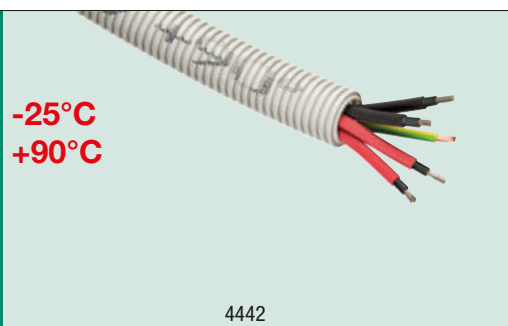
 <p>-25°C +90°C</p> <p>4442</p>	ITEM	COLOUR	UM	DESCRIPTION	PACK-AGING
	ECTP1825-FV3x4	GC	MT	Ø 25 mm prewired corrugated conduits Electrical cables: 3x4 mm ² Sheath colour: 1x black, 1x red, 1x Green/Yellow	60
	ECTP1825-FV5x4	GC	MT	Ø 25 mm prewired corrugated conduits Electrical cables: 5x4 mm ² Sheath colour: 2x black, 2x red, 1x Green/Yellow	30

MAIN TECHNICAL FEATURES ELECTRICAL CABLES:

- Cable: H1Z2Z2-K.
- With insulation and sheath elastomers, halogen-free flame retardant, low emission of toxic gas, low smoke.
- UV resistant.
- Nominal Voltage U₀/U 0,6/1.0 1,2 kV AC - 0,9/1,5 kV DC.
- Made in compliance with TUV 2 Pfg 1169/08,2007, EN 60216-1-2, EN 50267-2-1, IEC 60332.1, DIN VDE 0282-2.
- Insulation: halogen free crosslinked polyolefin.
- Twisted flexible tinned copper conductor.
- Sheath colour: black RAL 9005, red RAL 3013, Green/Yellow.
- Products meeting the essential requirements of L.V.D. 2014/35/UE.
- Products in compliance with RoHS II - 2011/65/UE directive.



SPIRAL FLEXIBLE PVC CONDUITS - CLASS. 2311 - GREY



2311

ITEM	COLOUR	UM	DESCRIPTION	PACK-AGING
EC GFE08	GC	MT	internal Ø 8	30/5400
EC GFE10	GC	MT	internal Ø 10	30/5400
EC GFE12	GC	MT	internal Ø 12	30/4590
EC GFE14	GC	MT	internal Ø 14	30/4050
EC GFE16	GC	MT	internal Ø 16	30/4050
EC GFE20	GC	MT	internal Ø 20	30/3360
EC GFE22	GC	MT	internal Ø 22	30/1800
EC GFE25	GC	MT	internal Ø 25	30/1800
EC GFE28	GC	MT	internal Ø 28	30/1650
EC GFE32	GC	MT	internal Ø 32	30/1440
EC GFE35	GC	MT	internal Ø 35	30/1200
EC GFE40	GC	MT	internal Ø 40	30/1200
EC GFE50	GC	MT	internal Ø 50	30/600
EC GFE60	GC	MT	internal Ø 60	30

SPIRAL FLEXIBLE PVC CONDUITS - CLASS. 2311 - BLACK



2311

ITEM	COLOUR	UM	DESCRIPTION	PACK-AGING
EC GFE08N	N	MT	internal Ø 8	30/5400
EC GFE10N	N	MT	internal Ø 10	30/5400
EC GFE12N	N	MT	internal Ø 12	30/4590
EC GFE14N	N	MT	internal Ø 14	30/4050
EC GFE16N	N	MT	internal Ø 16	30/4050
EC GFE20N	N	MT	internal Ø 20	30/3360
EC GFE22N	N	MT	internal Ø 22	30/1800
EC GFE25N	N	MT	internal Ø 25	30/1800
EC GFE28N	N	MT	internal Ø 28	30/1650
EC GFE32N	N	MT	internal Ø 32	30/1440
EC GFE35N	N	MT	internal Ø 35	30/1200
EC GFE40N	N	MT	internal Ø 40	30/1200
EC GFE50N	N	MT	internal Ø 50	30/600
EC GFE60N	N	MT	internal Ø 60	30

ITEM	COLOUR	UM	DESCRIPTION INTERNAL DIMENSIONS	PACK-AGING
------	--------	----	------------------------------------	------------

SPIRAL FLEXIBLE CONDUIT-BOX JOINTS GAS THREAD - IP65



EC GX10	GC	PCS	thread 1/4"	25/500
EC GX12	GC	PCS	thread 3/8"	25/500
EC GX14	GC	PCS	thread 1/2"	25/400
EC GX16	GC	PCS	thread 1/2"	25/350
EC GX20	GC	PCS	thread 3/4"	25/250
EC GX22	GC	PCS	thread 3/4"	25/250
EC GX25	GC	PCS	thread 1"	10/150
EC GX28	GC	PCS	thread 1"	10/120
EC GX32	GC	PCS	thread 1" and 1/4"	10/90
EC GX35	GC	PCS	thread 1" and 1/4"	10/70
EC GX40	GC	PCS	thread 1" and 1/2"	10/60
EC GX50	GC	PCS	thread 2"	10/50

Also available in black colour: item +N

ITEM	COLOUR	UM	DESCRIPTION INTERNAL DIMENSIONS	PACK-AGING
------	--------	----	------------------------------------	------------

SPIRAL FLEXIBLE CONDUIT-BOX JOINTS PG THREAD - IP65



EC GX10-9	GC	PCS	PG9	25/500
EC GX12-11	GC	PCS	PG11	25/500
EC GX12-13	GC	PCS	PG13,5	25/500
EC GX14-13	GC	PCS	PG13,5	25/400
EC GX16-11	GC	PCS	PG11	25/350
EC GX16-13	GC	PCS	PG13,5	25/350
EC GX16-16	GC	PCS	PG16	25/350
EC GX20-21	GC	PCS	PG21	25/250
EC GX22-21	GC	PCS	PG21	25/250
EC GX25-29	GC	PCS	PG29	10/150
EC GX28-29	GC	PCS	PG29	10/120
EC GX32-36	GC	PCS	PG36	10/90
EC GX35-36	GC	PCS	PG36	10/70

Also available in black colour: item +N

SPIRAL FLEXIBLE CONDUIT-BOX JOINTS METRIC THREAD - IP65



EC GX10M	GC	PCS	thread 15 mm	25/500
EC GX12M	GC	PCS	thread 16 mm	25/500
EC GX16M	GC	PCS	thread 20 mm	25/350
EC GX20M	GC	PCS	thread 25 mm	25/250
EC GX25M	GC	PCS	thread 32 mm	10/150
EC GX32M	GC	PCS	thread 40 mm	10/90
EC GX40M	GC	PCS	thread 50 mm	10/60
EC GX50M	GC	PCS	thread 55 mm	10/50

Also available in black colour: item +N

COUPLING FOR CORRUGATED CONDUITS

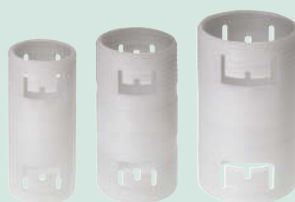

ITEM	COLOUR	UM	DESCRIPTION	PACK-AGING
EC MTC16	I	PCS	coupling Ø 16	100/2000
EC MTC20	I	PCS	coupling Ø 20	100/1200
EC MTC25	I	PCS	coupling Ø 25	100/700
EC MTC32	I	PCS	coupling Ø 32	50/400
EC MTC40	I	PCS	coupling Ø 40	300
EC MTC50	I	PCS	coupling Ø 50	150

COUPLING FOR CORRUGATED CONDUITS

ITEM	COLOUR	UM	DESCRIPTION	PACK-AGING
EC GFLEX16	I	PCS	coupling Ø 16	100/2000
EC GFLEX20	I	PCS	coupling Ø 20	100/1200
EC GFLEX25	I	PCS	coupling Ø 25	100/700
EC GFLEX32	I	PCS	coupling Ø 32	50/400
EC GFLEX40	I	PCS	coupling Ø 40	300
EC GFLEX50	I	PCS	coupling Ø 50	150

CAPS FOR CORRUGATED CONDUITS

ITEM	COLOUR	UM	DESCRIPTION	PACK-AGING
EC TFLEX16	I	PCS	cap Ø 16	100/2000
EC TFLEX20	I	PCS	cap Ø 20	100/2000
EC TFLEX25	I	PCS	cap Ø 25	100/1500
EC TFLEX32	I	PCS	cap Ø 32	50/800
EC TFLEX40	I	PCS	cap Ø 40	50/500
EC TFLEX50	I	PCS	cap Ø 50	50/300

GROUND BOXES

ITEM	COLOUR	UM	DESCRIPTION	PACK-AGING
EC POZ.20	GC	PCS	200x200	1
EC POZ.25	GC	PCS	250x250 watertight	1
EC POZ.30	GC	PCS	300x300	1
EC POZ.40	GC	PCS	400x400	1

INSPECTIONABLE 90° BENDS - IP40

ITEM	COLOUR	UM	DESCRIPTION	PACK-AGING
EC CI16	GC	PCS	90° bend Ø 16	100/400
EC CI20	GC	PCS	90° bend Ø 20	100/300
EC CI25	GC	PCS	90° bend Ø 25	50/200
EC CI32	GC	PCS	90° bend Ø 32	50/150

INSPECTIONABLE T JOINTS - IP40

ITEM	COLOUR	UM	DESCRIPTION	PACK-AGING
EC TI16	GC	PCS	T joint Ø 16	100/300
EC TI20	GC	PCS	T joint Ø 20	50/200
EC TI25	GC	PCS	T joint Ø 25	25/100
EC TI32	GC	PCS	T joint Ø 32	25/100

HALOGEN FREE 90° BENDS - IP40

ITEM	COLOUR	UM	DESCRIPTION	PACK-AGING
EC CRS16H	GC	PCS	90° bend Ø 16	50/1000
EC CRS20H	GC	PCS	90° bend Ø 20	50/600
EC CRS25H	GC	PCS	90° bend Ø 25	25/300
EC CRS32H	GC	PCS	90° bend Ø 32	100
EC CRS40H	GC	PCS	90° bend Ø 40	100
EC CRS50H	GC	PCS	90° bend Ø 50	50

HALOGEN FREE COUPLING - IP40

ITEM	COLOUR	UM	DESCRIPTION	PACK-AGING
EC GSH16H	GC	PCS	coupling Ø 16	100/1200
EC GSH20H	GC	PCS	coupling Ø 20	100/800
EC GSH25H	GC	PCS	coupling Ø 25	50/500
EC GSH32H	GC	PCS	coupling Ø 32	25/250
EC GSH40H	GC	PCS	coupling Ø 40	25/150
EC GSH50H	GC	PCS	coupling Ø 50	25/100

HALOGEN FREE SNAP CONDUIT CLIPS

ITEM	COLOUR	UM	DESCRIPTION	PACK-AGING
EC CF16	GC	PCS	clips Ø 16	100/1500
EC CF20	GC	PCS	clips Ø 20	100/1000
EC CF25	GC	PCS	clips Ø 25	100/1000
EC CF32	GC	PCS	clips Ø 32	50/800
EC CF40	GC	PCS	clips Ø 40	50/400
EC CF50	GC	PCS	clips Ø 50	25/250

90° BENDS - IP40

ITEM	COLOUR	UM	DESCRIPTION	PACK-AGING
EC CRS16	GC	PCS	90° bend Ø 16	50/1000
EC CRS20	GC	PCS	90° bend Ø 20	50/600
EC CRS25	GC	PCS	90° bend Ø 25	25/300
EC CRS32	GC	PCS	90° bend Ø 32	100
EC CRS40	GC	PCS	90° bend Ø 40	100
EC CRS50	GC	PCS	90° bend Ø 50	50

FLEXIBLE BENDS - IP44

ITEM	COLOUR	UM	DESCRIPTION	PACK-AGING
EC CV16	GC	PCS	flexible bend Ø 16	20/300
EC CV20	GC	PCS	flexible bend Ø 20	20/200
EC CV25	GC	PCS	flexible bend Ø 25	20/120
EC CV32	GC	PCS	flexible bend Ø 32	10/80

COUPLING - IP40

ITEM	COLOUR	UM	DESCRIPTION	PACK-AGING
EC GSU16	GC	PCS	coupling Ø 16	100/1200
EC GSU20	GC	PCS	coupling Ø 20	100/800
EC GSU25	GC	PCS	coupling Ø 25	50/500
EC GSU32	GC	PCS	coupling Ø 32	25/250
EC GSU40	GC	PCS	coupling Ø 40	25/150
EC GSU50	GC	PCS	coupling Ø 50	25/100

SMOOTH JOINTS - IP40

ITEM	COLOUR	UM	DESCRIPTION	PACK-AGING
EC GI16	GC	PCS	joint Ø 16	100/2000
EC GI20	GC	PCS	joint Ø 20	100/1200
EC GI25	GC	PCS	joint Ø 25	100/700
EC GI32	GC	PCS	joint Ø 32	400
EC GI40	GC	PCS	joint Ø 40	200
EC GI50	GC	PCS	joint Ø 50	100

CONDUIT-BOX JOINTS - IP65

ITEM	COLOUR	UM	DESCRIPTION	PACK-AGING
EC BS16	GC	PCS	conduit-box Ø 16	10/350
EC BS20	GC	PCS	conduit-box Ø 20	10/350
EC BS25	GC	PCS	conduit-box Ø 25	100/200
EC BS32	GC	PCS	conduit-box Ø 32	10/100
EC BS40	GC	PCS	conduit-box Ø 40	5/80
EC BS50	GC	PCS	conduit-box Ø 50	5/40

CONDUIT-CONDUIT JOINTS - IP65

ITEM	COLOUR	UM	DESCRIPTION	PACK-AGING
EC MS16	GC	PCS	conduit-conduit Ø 16	10/350
EC MS20	GC	PCS	conduit-conduit Ø 20	10/200
EC MS25	GC	PCS	conduit-conduit Ø 25	100/200
EC MS32	GC	PCS	conduit-conduit Ø 32	10/100
EC MS40	GC	PCS	conduit-conduit Ø 40	5/80
EC MS50	GC	PCS	conduit-conduit Ø 50	5/40

RIGID-FLEXIBLE CONDUIT JOINTS - IP65

ITEM	COLOUR	UM	DESCRIPTION	PACK-AGING
EC GS16	GC	PCS	rigid Ø 16-flexible Ø 12	10/350
EC GS20	GC	PCS	rigid Ø 20-flexible Ø 16	10/350
EC GS25	GC	PCS	rigid Ø 25-flexible Ø 20	100/200
EC GS32	GC	PCS	rigid Ø 32-flexible Ø 25	10/100
EC GS40	GC	PCS	rigid Ø 40-flexible Ø 32	5/100
EC GS50	GC	PCS	rigid Ø 50-flexible Ø 40	5/40

RIGID-FLEXIBLE CONDUIT SAME DIAMETER JOINTS - IP65

ITEM	COLOUR	UM	DESCRIPTION	PACK-AGING
EC RS16	GC	PCS	rigid-flexible Ø 16	10/200
EC RS20	GC	PCS	rigid-flexible Ø 20	10/200
EC RS25	GC	PCS	rigid-flexible Ø 25	10/160
EC RS32	GC	PCS	rigid-flexible Ø 32	10/80
EC RS40	GC	PCS	rigid-flexible Ø 40	5/60
EC RS50	GC	PCS	rigid-flexible Ø 50	5/40

2 ACCESSORIES FOR CONDUIT SYSTEMS, FIXING SYSTEMS

ITEM	COLOUR	UM	DESCRIPTION	PACK-AGING
------	--------	----	-------------	------------

90° BENDS - IP65

	EC CS16	GC	PCS	90° bend Ø 16	10/200
	EC CS20	GC	PCS	90° bend Ø 20	10/200
	EC CS25	GC	PCS	90° bend Ø 25	10/100
	EC CS32	GC	PCS	90° bend Ø 32	10/50
	EC CS40	GC	PCS	90° bend Ø 40	5/20
	EC CS50	GC	PCS	90° bend Ø 50	12

FLEXIBLE BENDS - IP65

	EC CXT16	GC	PCS	flexible bend Ø 16	50/200
	EC CXT20	GC	PCS	flexible bend Ø 20	50/200
	EC CXT25	GC	PCS	flexible bend Ø 25	35/140
	EC CXT32	GC	PCS	flexible bend Ø 32	20/80
	EC CXT40	GC	PCS	flexible bend Ø 40	10/40
	EC CXT50	GC	PCS	flexible bend Ø 50	10/40

CONDUIT-BOX FLEXIBLE JOINTS - IP65

	EC CXS16	GC	PCS	conduit-box Ø 16	50/200
	EC CXS20	GC	PCS	conduit-box Ø 20	50/200
	EC CXS25	GC	PCS	conduit-box Ø 25	35/140
	EC CXS32	GC	PCS	conduit-box Ø 32	20/80
	EC CXS40	GC	PCS	conduit-box Ø 40	15/60
	EC CXS50	GC	PCS	conduit-box Ø 50	10/40

FLEXIBLE POLYMER CONDUIT / BOX COUPLING - IP44

	ECRM16-23	GC	PCS	Ø 16 mm - mounting Ø 23 mm	10/400
	ECRM20-23	GC	PCS	Ø 20 mm - mounting Ø 23 mm	10/400
	ECRM20-29	GC	PCS	Ø 20 mm - mounting Ø 29 mm	10/350
	ECRM25-29	GC	PCS	Ø 25 mm - mounting Ø 29 mm	10/300
	ECRM32-37	GC	PCS	Ø 32 mm - mounting Ø 37 mm	10/200
	ECRM40-37	GC	PCS	Ø 40 mm - mounting Ø 37 mm	5/100
	ECRM50-48	GC	PCS	Ø 50 mm - mounting Ø 48 mm	5/70

e@ssystem

ITEM	COLOUR	UM	DESCRIPTION	PACK-AGING
------	--------	----	-------------	------------

CONDUIT-BOX JOINTS - IP67

	EC 70016	GC	PCS	conduit-box Ø 16	25/500
	EC 70020	GC	PCS	conduit-box Ø 20	25/500
	EC 70025	GC	PCS	conduit-box Ø 25	25/400
	EC 70032	GC	PCS	conduit-box Ø 32	25/200
	EC 70040	GC	PCS	conduit-box Ø 40	10/100
	EC 70050	GC	PCS	conduit-box Ø 50	10/70

CONDUIT-CONDUIT JOINTS - IP67

	EC 71016	GC	PCS	conduit-conduit Ø 16	25/500
	EC 71020	GC	PCS	conduit-conduit Ø 20	25/400
	EC 71025	GC	PCS	conduit-conduit Ø 25	25/250
	EC 71032	GC	PCS	conduit-conduit Ø 32	25/150
	EC 71040	GC	PCS	conduit-conduit Ø 40	10/70
	EC 71050	GC	PCS	conduit-conduit Ø 50	10/50

RIGID-FLEXIBLE CONDUIT JOINTS - IP67

	EC 72016	GC	PCS	rigid-flexible Ø 16	25/500
	EC 72020	GC	PCS	rigid-flexible Ø 20	25/500
	EC 72025	GC	PCS	rigid-flexible Ø 25	25/300
	EC 72032	GC	PCS	rigid-flexible Ø 32	25/200
	EC 72040	GC	PCS	rigid-flexible Ø 40	10/100
	EC 72050	GC	PCS	rigid-flexible Ø 50	10/60

90° BENDS - IP67

	EC 73016	GC	PCS	90° bend Ø 16	25/300
	EC 73020	GC	PCS	90° bend Ø 20	25/200
	EC 73025	GC	PCS	90° bend Ø 25	25/100
	EC 73032	GC	PCS	90° bend Ø 32	10/50
	EC 73040	GC	PCS	90° bend Ø 40	10/30
	EC 73050	GC	PCS	90° bend Ø 50	15

3 IP67 ACCESSORIES FOR RIGID CONDUIT "SECURITY SYSTEM"

NUOVO SECURITY SYSTEM

ITEM	COLOUR	UM	DESCRIPTION	PACK-AGING
------	--------	----	-------------	------------

CONDUIT-BOX JOINTS - IP67 - CO-MOULDED GASKET

	EC 74116	GC	PCS	conduit-box Ø 16	10/350
	EC 74120	GC	PCS	conduit-box Ø 20	10/350
	EC 74125	GC	PCS	conduit-box Ø 25	10/200
	EC 74132	GC	PCS	conduit-box Ø 32	10/100
	EC 74140	GC	PCS	conduit-box Ø 40	5/80
	EC 74150	GC	PCS	conduit-box Ø 50	5/40

CONDUIT-CONDUIT JOINTS - IP67 - CO-MOULDED GASKET

	EC 74016	GC	PCS	conduit-conduit Ø 16	10/250
	EC 74020	GC	PCS	conduit-conduit Ø 20	10/200
	EC 74025	GC	PCS	conduit-conduit Ø 25	10/150
	EC 74032	GC	PCS	conduit-conduit Ø 32	10/100
	EC 74040	GC	PCS	conduit-conduit Ø 40	5/50
	EC 74050	GC	PCS	conduit-conduit Ø 50	5/40

RIGID-FLEXIBLE CONDUIT JOINTS - IP67 - CO-MOULDED GASKET

	EC 74216	GC	PCS	rigid-flexible Ø 16	10/350
	EC 74220	GC	PCS	rigid-flexible Ø 20	10/250
	EC 74225	GC	PCS	rigid-flexible Ø 25	10/200
	EC 74232	GC	PCS	rigid-flexible Ø 32	10/100
	EC 74240	GC	PCS	rigid-flexible Ø 40	5/80
	EC 74250	GC	PCS	rigid-flexible Ø 50	5/40

90° BENDS - IP67 - CO-MOULDED GASKET

	EC 74316	GC	PCS	90° bend Ø 16	10/150
	EC 74320	GC	PCS	90° bend Ø 20	10/100
	EC 74325	GC	PCS	90° bend Ø 25	10/100
	EC 74332	GC	PCS	90° bend Ø 32	10/50
	EC 74340	GC	PCS	90° bend Ø 40	5/20
	EC 74350	GC	PCS	90° bend Ø 50	5/15

Ø 3 mm NYLON CABLE DRAW TAPE



ITEM	COLOUR	UM	DESCRIPTION	PACK-AGING
EC S3-05	I	PCS	5 mt	340
EC S3-10	I	PCS	10 mt	180
EC S3-15	I	PCS	15 mt	120
EC S3-20	I	PCS	20 mt	90
EC S3-25	I	PCS	25 mt	70
EC S3-30	I	PCS	30 mt	60

Ø 4 mm NYLON CABLE DRAW TAPE



ITEM	COLOUR	UM	DESCRIPTION	PACK-AGING
EC S4-05	I	PCS	5 mt	200
EC S4-10	I	PCS	10 mt	100
EC S4-15	I	PCS	15 mt	60
EC S4-20	I	PCS	20 mt	50
EC S4-25	I	PCS	25 mt	40
EC S4-30	I	PCS	30 mt	36

ITEM	COLOUR	UM	DESCRIPTION	PACK-AGING
------	--------	----	-------------	------------

HALOGEN FREE SNAP CONDUIT CLIPS



EC CF16	GC	PCS	clips Ø 16	100/1500
EC CF20	GC	PCS	clips Ø 20	100/1000
EC CF25	GC	PCS	clips Ø 25	100/1000
EC CF32	GC	PCS	clips Ø 32	50/800
EC CF40	GC	PCS	clips Ø 40	50/400
EC CF50	GC	PCS	clips Ø 50	25/250

MODULAR FIXING GUIDE FOR CF AND CFC SERIES



EC GC	GC	PCS	L=200 mm	400
--------------	----	-----	----------	-----

CONDUIT CLIPS WITH PLUG AND STEEL SCREW



EC CT16	GC	PCS	clips Ø 16	100/1000
EC CT20	GC	PCS	clips Ø 20	100/1000
EC CT25	GC	PCS	clips Ø 25	100/800
EC CT32	GC	PCS	clips Ø 32	50/400

CLAMP CONDUIT CLIPS



EC C12	GC	PCS	clips Ø 12-20	100/1400
EC C16	GC	PCS	clips Ø 14-22	100/1000
EC C25	GC	PCS	clips Ø 23-35	50/500
EC C50	GC	PCS	clips Ø 38-50	50/250

COLLAR CONDUIT CLIPS



EC CFC16	GC	PCS	clips Ø 16	100/1000
EC CFC20	GC	PCS	clips Ø 20	100/1000
EC CFC25	GC	PCS	clips Ø 25	100/800
EC CFC32	GC	PCS	clips Ø 32	50/500
EC CFC40	GC	PCS	clips Ø 40	150/400
EC CFC50	GC	PCS	clips Ø 50	25/250

**new items
in this page**

ITEM	COLOUR	UM	DESCRIPTION	PACK-AGING
------	--------	----	-------------	------------

TIE CONDUIT CLIPS



EC CFF1	GC	PCS	min. Ø 16 - max Ø 32	100/1400
EC CFF2	GC	PCS	min. Ø 32 - max Ø 63	50/700

ROUND CLIPS WITH ASSEMBLED STEEL NAIL - WHITE*



EC GT4BW50	B	BLISTER	round clip 3-4 mm	1/400
EC GT6BW50	B	BLISTER	round clip 5-6 mm	1/240
EC GT7BW50	B	BLISTER	round clip 6-7 mm	1/240
EC GT8BW50	B	BLISTER	round clip 7-8 mm	1/200
EC GT10BW50	B	BLISTER	round clip 9-10 mm	1/120
EC GT13BW50	B	BLISTER	round clip 13-14 mm	1/100
EC GT16BW50	B	BLISTER	round clip 15-16 mm	1/80
EC GT19BW50	B	BLISTER	round clip 19-20 mm	1/60
EC GT25BW50	B	BLISTER	round clip 25-26 mm	1/32

* 50 pcs per blister

ROUND CLIPS WITH ASSEMBLED STEEL NAIL - GREY*



EC GT4GW50	GC	BLISTER	round clip 3-4 mm	1/400
EC GT6GW50	GC	BLISTER	round clip 5-6 mm	1/240
EC GT7GW50	GC	BLISTER	round clip 6-7 mm	1/240
EC GT8GW50	GC	BLISTER	round clip 7-8 mm	1/200
EC GT10GW50	GC	BLISTER	round clip 9-10 mm	1/120
EC GT13GW50	GC	BLISTER	round clip 13-14 mm	1/100
EC GT16GW50	GC	BLISTER	round clip 15-16 mm	1/80
EC GT19GW50	GC	BLISTER	round clip 19-20 mm	1/60
EC GT25GW50	GC	BLISTER	round clip 25-26 mm	1/32

* 50 pcs per blister

PLUGS WITH SCREWS



EC TC5	GC	PCS	plug 5 mm	100/6000
EC TC6	GC	PCS	plug 6 mm	100/5000
EC TC8	GC	PCS	plug 8 mm	100/3000
EC TC10	GC	PCS	plug 10 mm	100/1500

NATURAL NYLON CABLE TIES

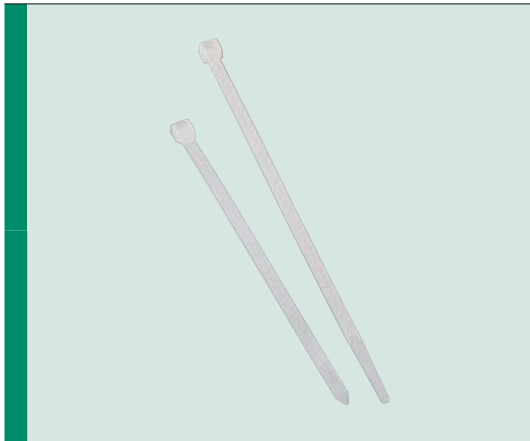

ITEM	COLOUR	UM	DESCRIPTION	PACK-AGING
EC 8008024	I	PCS	80x2,4	100/5000
EC 8001025	I	PCS	100x2,5	100/5000
EC 8001225	I	PCS	120x2,5	100/5000
EC 8001625	I	PCS	160x2,5	100/5000
EC 8002025	I	PCS	200x2,5	100/5000
EC 8001436	I	PCS	140x3,6	100/5000
EC 8002036	I	PCS	200x3,6	100/5000
EC 8002936	I	PCS	290x3,6	100/5000
EC 8001648	I	PCS	160x4,8	100/5000
EC 8002048	I	PCS	200x4,8	100/5000
EC 8002548	I	PCS	250x4,8	100/5000
EC 8002948	I	PCS	290x4,8	100/4000
EC 8003648	I	PCS	360x4,8	100/3000
EC 8004348	I	PCS	430x4,8	100/3000
EC 8002976	I	PCS	290x7,6	100/2000
EC 8003676	I	PCS	360x7,6	100/2000
EC 8004390	I	PCS	430x9,0	100/1000
EC 8005390	I	PCS	530x9,0	100/1000

BLACK NYLON CABLE TIES



ITEM	COLOUR	UM	DESCRIPTION	PACK-AGING
EC 8108024	N	PCS	80x2,4	100/5000
EC 8101025	N	PCS	100x2,5	100/5000
EC 8101225	N	PCS	120x2,5	100/5000
EC 8101625	N	PCS	160x2,5	100/5000
EC 8102025	N	PCS	200x2,5	100/5000
EC 8101436	N	PCS	140x3,6	100/5000
EC 8102036	N	PCS	200x3,6	100/5000
EC 8102936	N	PCS	290x3,6	100/5000
EC 8101648	N	PCS	160x4,8	100/5000
EC 8102048	N	PCS	200x4,8	100/5000
EC 8102548	N	PCS	250x4,8	100/5000
EC 8102948	N	PCS	290x4,8	100/4000
EC 8103648	N	PCS	360x4,8	100/3000
EC 8104348	N	PCS	430x4,8	100/3000
EC 8102976	N	PCS	290x7,6	100/2000
EC 8103676	N	PCS	360x7,6	100/2000
EC 8104390	N	PCS	430x9,0	100/1000
EC 8105390	N	PCS	530x9,0	100/1000

NATURAL 2-WAY ADHESIVE BASES



ITEM	COLOUR	UM	DESCRIPTION	PACK-AGING
EC 83036	I	PCS	19x19	100/5000
EC 83048	I	PCS	27x27	100/5000

BLACK 2-WAY ADHESIVE BASES



ITEM	COLOUR	UM	DESCRIPTION	PACK-AGING
EC 84036	N	PCS	19x19	100/5000
EC 84048	N	PCS	27x27	100/5000

NATURAL SCREW FISSABLE SUPPORTS



ITEM	COLOUR	UM	DESCRIPTION	PACK-AGING
EC 85048	I	PCS	15x9,5	100/5000
EC 85090	I	PCS	22x16	100/5000

BLACK SCREW FISSABLE SUPPORTS



ITEM	COLOUR	UM	DESCRIPTION	PACK-AGING
EC 86048	N	PCS	15x9,5	100/5000
EC 86090	N	PCS	22x16	100/5000

CABLE TIES FOR LABEL



ITEM	COLOUR	UM	DESCRIPTION	PACK-AGING
EC 8701025	I	PCS	100x2,5	100/5000
EC 8702025	I	PCS	200x2,5	100/5000

PLUG FOR CABLE TIES



ITEM	COLOUR	UM	DESCRIPTION	PACK-AGING
EC 88085	N	PCS	8 mm	100/5000

PG-THREAD CABLE GLANDS WITHOUT LOCK NUT - GREY - IP68



ITEM	COLOUR	UM	DESCRIPTION	PACK-AGING
EC 50007	GC	PCS	PG7	50/1200
EC 50009	GC	PCS	PG9	50/1200
EC 50011	GC	PCS	PG11	50/600
EC 50013	GC	PCS	PG13,5	50/600
EC 50016	GC	PCS	PG16	50/300
EC 50021	GC	PCS	PG21	50/300
EC 50029	GC	PCS	PG29	25/150
EC 50036	GC	PCS	PG36	15/90
EC 50042	GC	PCS	PG42	10/60
EC 50048	GC	PCS	PG48	5/30

PG-THREAD CABLE GLANDS WITH LOCK NUT - GREY - IP68



ITEM	COLOUR	UM	DESCRIPTION	PACK-AGING
EC 51007	GC	PCS	PG7	50/1200
EC 51009	GC	PCS	PG9	50/1200
EC 51011	GC	PCS	PG11	50/600
EC 51013	GC	PCS	PG13,5	50/600
EC 51016	GC	PCS	PG16	50/300
EC 51021	GC	PCS	PG21	50/300
EC 51029	GC	PCS	PG29	25/150
EC 51036	GC	PCS	PG36	15/90
EC 51042	GC	PCS	PG42	10/60
EC 51048	GC	PCS	PG48	5/30

PG-THREAD CABLE GLANDS WITH LOCK NUT - BLACK - IP68



ITEM	COLOUR	UM	DESCRIPTION	PACK-AGING
EC 51007N	N	PCS	PG7	50/1200
EC 51009N	N	PCS	PG9	50/1200
EC 51011N	N	PCS	PG11	50/600
EC 51013N	N	PCS	PG13,5	50/600
EC 51016N	N	PCS	PG16	50/300
EC 51021N	N	PCS	PG21	50/300
EC 51029N	N	PCS	PG29	25/150
EC 51036N	N	PCS	PG36	15/90
EC 51042N	N	PCS	PG42	10/60
EC 51048N	N	PCS	PG48	5/30

METRIC THREAD CABLE GLANDS WITH LOCK NUT - GREY - IP68



ITEM	COLOUR	UM	DESCRIPTION	PACK-AGING
EC 54016	GC	PCS	thread 16x1,5	100/600
EC 54020	GC	PCS	thread 20x1,5	100/600
EC 54025	GC	PCS	thread 25x1,5	50/300
EC 54032	GC	PCS	thread 32x1,5	25/150
EC 54040	GC	PCS	thread 40x1,5	15/90
EC 54050	GC	PCS	thread 50x1,5	10/60

ITEM	COLOUR	UM	DESCRIPTION	PACK-AGING
------	--------	----	-------------	------------

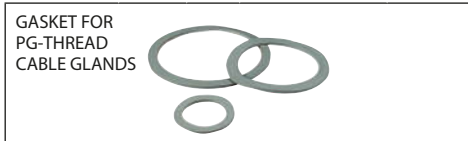

EC 53007	GC	PCS	PG7	100/1000
EC 53009	GC	PCS	PG9	100/1000
EC 53011	GC	PCS	PG11	100/1000
EC 53013	GC	PCS	PG13,5	100/1000
EC 53016	GC	PCS	PG16	100/500
EC 53021	GC	PCS	PG21	100/500
EC 53029	GC	PCS	PG29	100/500
EC 53036	GC	PCS	PG36	50/500
EC 53042	GC	PCS	PG42	50/500
EC 53048	GC	PCS	PG48	50/500

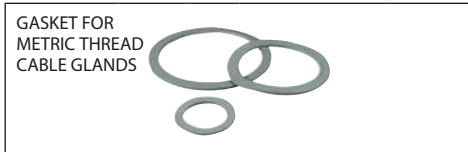

EC 53016M	GC	PCS	gasket 16	100/1000
EC 53020M	GC	PCS	gasket 20	100/1000
EC 53025M	GC	PCS	gasket 25	100/500
EC 53032M	GC	PCS	gasket 32	100/500
EC 53040M	GC	PCS	gasket 40	50/500
EC 53050M	GC	PCS	gasket 50	50/500

ITEM	COLOUR	UM	DESCRIPTION	PACK-AGING
------	--------	----	-------------	------------



EC 52007	GC	PCS	PG7	50/1000
EC 52009	GC	PCS	PG9	50/1000
EC 52011	GC	PCS	PG11	50/1000
EC 52013	GC	PCS	PG13,5	50/1000
EC 52016	GC	PCS	PG16	50/500
EC 52021	GC	PCS	PG21	50/500
EC 52029	GC	PCS	PG29	25/500
EC 52036	GC	PCS	PG36	25/500
EC 52042	GC	PCS	PG42	10/500
EC 52048	GC	PCS	PG48	10/500



EC 52016M	GC	PCS	lock nut 16	50/500
EC 52020M	GC	PCS	lock nut 20	50/500
EC 52025M	GC	PCS	lock nut 25	25/500
EC 52032M	GC	PCS	lock nut 32	25/300
EC 52040M	GC	PCS	lock nut 40	10/300
EC 52050M	GC	PCS	lock nut 50	10/300

ITEM	COLOUR	UM	DESCRIPTION	PACK-AGING
------	--------	----	-------------	------------



EC 52207	GC	PCS	PG7	100/1000
EC 52209	GC	PCS	PG9	100/1000
EC 52211	GC	PCS	PG11	100/1000
EC 52213	GC	PCS	PG13,5	100/1000
EC 52216	GC	PCS	PG16	100/1000
EC 52221	GC	PCS	PG21	100/1000
EC 52229	GC	PCS	PG29	50/500
EC 52236	GC	PCS	PG36	50/500
EC 52242	GC	PCS	PG42	50
EC 52248	GC	PCS	PG48	50



EC 52312	GC	PCS	thread M 12	100/1000
EC 52316	GC	PCS	thread M 16	100/1000
EC 52320	GC	PCS	thread M 20	100/1000
EC 52325	GC	PCS	thread M 25	100/1000
EC 52332	GC	PCS	thread M 32	50/500
EC 52340	GC	PCS	thread M 40	50/500
EC 52350	GC	PCS	thread M 50	50
EC 52363	GC	PCS	thread M 63	50

EQUIPOTENTIAL PLATES WITH COVER

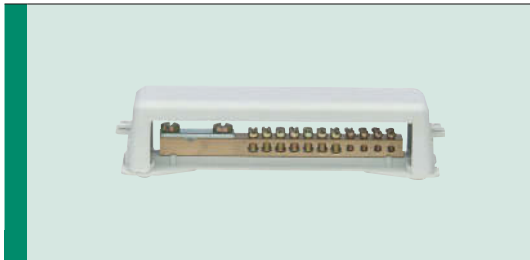

ITEM	COLOUR	UM	DESCRIPTION	PACK-AGING
EC 890020	GC	PCS	21 holes	1/40
EC 890021	GC	PCS	12 holes	1/150

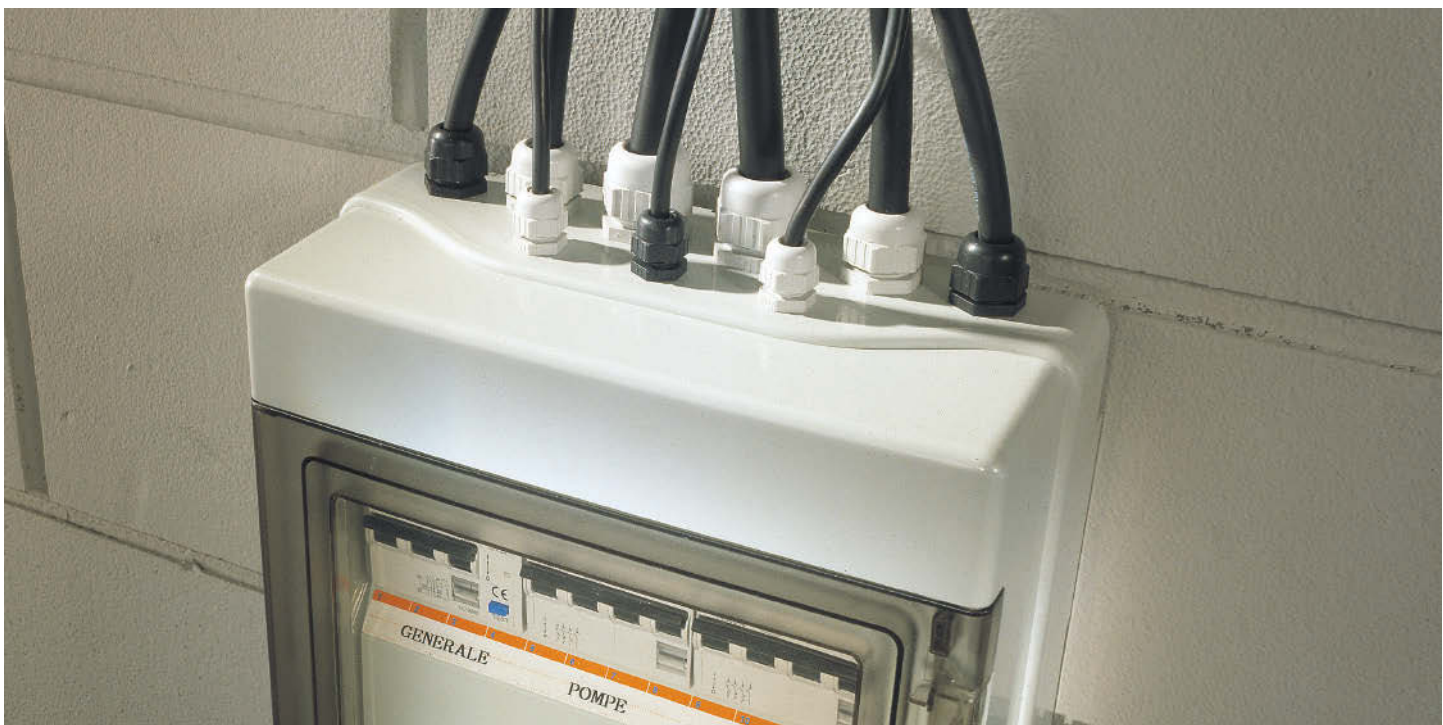

INSULATING ADHESIVE TAPE - 15 mm x 10 MT



ITEM	COLOUR	UM	DESCRIPTION	PACK-AGING
EC 891010		PCS	Insulating adhesive tape 15x10 - Yellow/ Green	10/200
EC 891011		PCS	Insulating adhesive tape 15x10 - Blue	10/200
EC 891012		PCS	Insulating adhesive tape 15x10 - Red	10/200
EC 891013		PCS	Insulating adhesive tape 15x10 - Grey	10/200
EC 891014		PCS	Insulating adhesive tape 15x10 - White	10/200
EC 891015		PCS	Insulating adhesive tape 15x10 - Black	10/200

INSULATING ADHESIVE TAPE - 19 mm x 25 MT



ITEM	COLOUR	UM	DESCRIPTION	PACK-AGING
EC 891020		BARS	Insulating adhesive tape 19x25 - Yellow/ Green	10/100
EC 891021		BARS	Insulating adhesive tape 19x25 - Blue	10/100
EC 891022		BARS	Insulating adhesive tape 19x25 - Red	10/100
EC 891023		BARS	Insulating adhesive tape 19x25 - Grey	10/100
EC 891024		BARS	Insulating adhesive tape 19x25 - White	10/100
EC 891025		BARS	Insulating adhesive tape 19x25 - Black	10/100

TRANSPARENT UNIPOLAR TERMINAL BLOCKS



ITEM	COLOUR	UM	DESCRIPTION	PACK-AGING
EC 890010	I	BARS	section 1,5 mmq bars of 10 blocks	10/900
EC 890011	I	BARS	section 2,5 mmq bars of 10 blocks	10/500
EC 890012	I	BARS	section 4 mmq bars of 10 blocks	10/400
EC 890013	I	BARS	section 6 mmq bars of 10 blocks	10/250
EC 890014	I	BARS	section 10 mmq bars of 10 blocks	10/200
EC 890015	I	BARS	section 16 mmq bars of 10 blocks	10/100
EC 890016	I	PCS	section 25 mmq	5/450
EC 890017	I	PCS	section 35 mmq	5/240

THREE-PIECE THERMOPLASTIC LAMP HOLDER-PLAIN



ITEM	COLOUR	UM	DESCRIPTION	PACK-AGING
EC K52001		PCS	E14 - 250V - 2A - plain outer shell - white	10
EC K52002		PCS	E14 - 250V - 2A - plain outer shell - black	10
EC K52003		PCS	E14 - 250V - 2A - plain outer shell - white	10
EC K52004		PCS	E14 - 250V - 2A - plain outer shell - black	10

THREE-PIECE THERMOPLASTIC LAMP HOLDER-THREADED



ITEM	COLOUR	UM	DESCRIPTION	PACK-AGING
EC K52010		PCS	E14 - 250V - 2A - threaded outer shell with ring - white	10
EC K52011		PCS	E14 - 250V - 2A - threaded outer shell with ring - black	10
EC K52015		PCS	E27 - 250V - 2A - threaded outer shell with ring - white	10
EC K52016		PCS	E27 - 250V - 2A - threaded outer shell with ring - black	10

THREE-PIECE METALLIC LAMP HOLDER-THREADED



ITEM	COLOUR	UM	DESCRIPTION	PACK-AGING
EC K52018		PCS	E27 - 250V - 4A - threaded outer shell with ring - gold	10

Copyright© 2020 - The partial reproduction is strictly prohibited without written permission by the company. Elettrocantali Spa reserves the right to make changes and improvements necessary to comply the products with the changes of the Reference Standards and production processes, to modify the data, the measures and any information contained in this catalog without any notice.

For reasons related to the printing processes, the colours of the products contained in this catalog may differ from reality.



ELETTROCANALI S.p.a.

Via Generale Dalla Chiesa, 18
24020 SCANZOROSCIATE (BG) Italia
Tel. +39 035 665077/668264
Fax +39 035 655475/6590705
info@elettrocanali.com

Filiale:

Via Pianodardine 16/B - 83100 AVELLINO (AV) Italia
Tel. +39 0825 624128/9 - Fax +39 0825 622223
info@elettrocanali-av.com

www.elettrocanali.com